



**GROTE®**  
**VEHICLE**  
**LIGHTING**  
**SYSTEMS**

**REFERENCE GUIDE**

*LED INTERIOR & EXTERIOR*

*TRAILER KITS | POWER CORDS*

*EMERGENCY | WIRE HARNESS*

*RECREATION & OFF ROAD*

**Grote®**

# GROTE®: A WORLDWIDE LEADER IN VEHICLE LIGHTING AND SAFETY SYSTEMS

Our customers span the globe. So do we.

**Grote Industries Headquarters**, located in Madison, Indiana, USA, continually redefines and improves lighting technology for the international vehicle safety and vocational markets.



**Grote Europe**, located in Bogen, Germany, is Grote's European headquarters and is responsible for design and production of lighting safety systems to meet specific European requirements.



**Grote Electronics**, located in Waterloo, Canada, is a state-of-the-art, high-volume manufacturing facility dedicated to assembling Grote's light emitting diode (LED) circuit boards and electronic-based specialty products.



**Grote of Canada**, located in Markham, Ontario, is the headquarters for the manufacturing and development of the Grote Electrical Accessory lines, serving the original equipment and aftermarket channels for the entire Canadian market.



**Grote Latin America**, located in Monterrey, Mexico, is responsible for development and production of Grote wiring and trailer harnesses, including Grote's patented ULTRA-BLUE-SEAL® pigtail and harness system.



**Grote Asia**, located in Shanghai and Zhuzhou, China, is a wholly-owned foreign enterprise of Grote Industries, formed in November 2007 as an answer to continuous cost reduction and consolidation of imported products.





## TABLE OF CONTENTS

- |  |  |
|--|--|
| <p><b>GP</b> GROTE® PRODUCT PLATFORM<br/>PLATEFORME DE PRODUITS GROTE®<br/>PLATAFORMA DE PRODUCTOS GROTE®<br/>18-33</p> <hr/> <p><b>01</b> CLEARANCE/MARKER LAMPS<br/>FEUX DE GABARIT / POSITION<br/>LÁMPARAS DE GÁLIBO / DEMARCADORA<br/>34-73</p> <hr/> <p><b>02</b> STOP/TAIL/TURN LAMPS<br/>FEUX ARRÊT / ARRIÈRE / DIRECTION<br/>LÁMPARAS DE FRENO / CUARTO / DIRECCIONAL<br/>74-109</p> <hr/> <p><b>03</b> LIGHT DUTY TRAILER LIGHTING<br/>ÉCLAIRAGE POUR REMORQUE LÉGÈRE<br/>ILUMINACIÓN PARA REMOLQUE, PARA<br/>TRABAJO LIVIANO<br/>110-117</p> <hr/> <p><b>04</b> LICENSE AND BACK-UP<br/>FEUX DE PLAQUE D'IMMATRICULATION ET DE REcul<br/>LÁMPARAS DE PLACA / REVERSA<br/>118-133</p> <hr/> <p><b>05</b> INTERIOR LIGHTING<br/>LUMIÈRES D'INTÉRIEUR<br/>LÁMPARAS PARA INTERIOR<br/>134-151</p> <hr/> <p><b>06</b> XTL® APPLICATIONS, CREATIVITY<br/>XTL® UTILISATIONS, CRÉATIVITÉ<br/>XTL® APLICACIONES, CREATIVIDAD<br/>152-157</p> <hr/> <p><b>07</b> FORWARD LIGHTING<br/>PHARES UTILITAIRES<br/>FAROS DELANTEROS<br/>158-167</p> <hr/> <p><b>08</b> WORK LIGHTING<br/>LAMPE DE TRAVAIL<br/>ILUMINACIÓN DE TRABAJO<br/>168-189</p> | <p><b>09</b> WARNING AND HAZARD<br/>GYROPHARES ET FEUX D'AVERTISSEMENT<br/>LÁMPARAS DE ADVERTENCIA Y PRECAUCIÓN<br/>190-209</p> <hr/> <p><b>10</b> FLASHERS AND<br/>TURN SIGNAL SWITCHES<br/>CLIGNOTANTS ET COMMUTATEURS<br/>PALANCAS DIRECCIONALES / DESTELLADORES<br/>210-219</p> <hr/> <p><b>11</b> MIRRORS<br/>RÉTROVISEURS<br/>ESPEJOS<br/>220-233</p> <hr/> <p><b>12</b> TRAILER WIRING AND<br/>COMMUNICATIONS SYSTEMS<br/>SYSTÈMES DE COMMUNICATION ET<br/>FILAGE DE REMORQUES<br/>SISTEMAS DE ARNESES PARA REMOLQUE /<br/>CAJA DE CONEXIÓN<br/>234-253</p> <hr/> <p><b>13</b> PIGTAILS<br/>SPIRALES DE RACCORD<br/>CONECTORES<br/>254-263</p> <hr/> <p><b>14</b> MOUNTING OPTIONS<br/>OPTIONS DE FIXATION<br/>OPCIONES DE MONTAJE<br/>264-283</p> <hr/> <p><b>15</b> REFLECTORS<br/>RÉFLECTEURS<br/>REFLECTANTES<br/>284-289</p> <hr/> <p><b>16</b> MISCELLANEOUS<br/>AUTRES<br/>MISCELÁNEA<br/>290-293</p> <hr/> <p><b>17</b> TECHNICAL INFORMATION<br/>INFORMATION TECHNIQUE<br/>INFORMACIÓN TÉCNICA<br/>294-320</p> |
|--|--|

# VISIT **GROTE.COM** TO GET THE MOST UP-TO-DATE PRODUCT INFORMATION

Whether you prefer desktop, tablet, or mobile, **GROTE.COM** puts all the Grote® lighting and electrical accessory information at your fingertips, wherever you may be.



## **GROTE.COM – THE ULTIMATE REFERENCE!**

- **HIGH-RESOLUTION IMAGERY**
- **UP-TO-DATE STATS AND INFORMATION**
- **UNIQUE 360° VIEWS OF MANY PRODUCTS**
- **LATEST PRODUCT RELEASES**



# ***SIGN-UP FOR GROTE'S ENHANCED G24/7 VISIT [ORDERS.GROTE.COM](http://ORDERS.GROTE.COM)***



Grote® Industries is pleased to announce the launch of the enhanced G24/7 system. This complimentary service is an innovative way to place orders, track order status and view all your Grote® product activity. From the convenience of your computer or mobile device, you can now access previously unavailable information that will help you more successfully manage your business and inventory.

## ***ORDERS.GROTE.COM***

### **NEW FEATURES**

- ***PAY ANY INVOICE ONLINE ANY TIME***
- ***EASY CREDIT CARD PROCESSING***
- ***NOW MOBILE FRIENDLY***
- ***REPRINT PACKING LISTS AND INVOICES***



#### ***UPLOAD FROM MICROSOFT® EXCEL***

Customers can also upload items from Microsoft® Excel to create orders.

#### ***REFER AND REORDER USING "MY LIST"***

The user can create a list of products for future reference or to reorder.

#### ***E-MAIL NOTIFICATION***

When a new order is created and when an order is shipped, unlimited recipients can receive an instant e-mail notification.

#### ***ORDER ENTRY ONLINE BY CUSTOMER PART NUMBER***

### ***USING G24/7, YOU CAN QUICKLY AND EASILY:***

- Track the status of current orders
- Check the status of backorders
- Check for substitutions or replacements for obsolete parts
- Check Grote® inventory availability
- Confirm ship dates
- Link to shipping carrier
- View invoice information
- Track credits
- View weight & packaging information
- View previously placed orders
- View product technical information
- Reprint packing lists and invoices





## GROTE® PRODUCT NUMBERING SYSTEM

Grote® uses a meaningful product numbering system that makes it possible to quickly locate the correct product and verify the correct product has been

selected. The typical Grote® part number contains five digits, followed by a hyphen, followed by a single digit. Here's what it all means.

The first four digits or alpha characters (00000-0) indicate the product category.

0000 Displays  
 4000 Reflectors  
 4210 Brackets and Permit Holders  
 4400 Switches  
 4450 Flashers  
 4500 Clearance/Marker/Cab/ID or Bar Lamps  
 4600 Clearance/Marker/Cab/ID or Bar Lamps  
 4700 Clearance/Marker/Cab/ID or Bar Lamps  
 4800 Turn Signal Switch  
 4900 Clearance/Marker/Cab/ID or Bar Lamps  
 5000 Combination S/T/T or single function turn lamps  
 5100 Combination S/T/T or single function turn lamps  
 5200 Combination S/T/T or single function turn lamps  
 5300 Combination S/T/T or single function turn lamps  
 5400 Combination S/T/T or single function turn lamps  
 5500 Combination S/T/T or single function turn lamps  
 5600 Combination S/T/T or single function turn lamps  
 5700 Combination S/T/T or single function turn lamps  
 5800 Combination S/T/T or single function turn lamps  
 5900 Combination S/T/T or single function turn lamps  
 6000 License Lamp/Courtesy Lamps  
 6100 Dome/Map/Stepwell  
 6200 Back-up lamps  
 6300 Flood/Fog/Tractor/Driving Lamp  
 6400 Flood/Fog/Tractor/Driving Lamp

6500 Boat Kits  
 6600 Spliceless Harness System  
 6700 Wire Kits/Pigtail and Wire Ass'y European System  
 6750 Rear Sills  
 6800 Wire Kits/Pigtails  
 6850 Main Harnesses  
 6900 T/S Harness Kits  
 7000 Flags  
 7100 Flares  
 7200 Fuses and Horns  
 7300 Back-up Alarms  
 7600 Roto Beacons  
 7700 School Bus  
 7800 Warning  
 8200 Military Lamps  
 8300 Military Lamps  
 8500 Automotive Replacement lenses  
 8600 Automotive Replacement lenses  
 8700 Cable Assemblies  
 8720 7-Way Plug and Socket  
 8730 7-Way Plug and Socket  
 8740 Spring  
 8750 Inserts used on 6/7 plug and sockets  
 8760 Boots  
 8770 Replacement Motors and Elec. Equip.  
 9000 Lens Assemblies  
 9800 Misc. Packaged Items  
 9900 Misc. Packaged Items

The next digit or alpha character (00000-0) indicate the product color or finish.

| Lens           | Finish                   |
|----------------|--------------------------|
| 0 Two colors   | 1 White                  |
| 1 Clear, white | 2 Black                  |
| 2 Red          | 3 Chrome/Stainless Steel |
| 3 Yellow       | 4 Aluminum               |
| 4 Green        | 5 Zinc                   |
| 5 Blue         |                          |

The sixth digit (00000-0) indicates packaging.

0 Item only  
 1 Ind. Display  
 2 Ind. Plain  
 3 Bulk  
 4 Pair Pack  
 5 Bubble Pack, Display Pack, Clam Shell or Retail Pack  
 6 Fleet Pack  
 7 Multiple Pack (Kit)

The absence of the sixth digit indicates product is in standard shelf packaging, e.g., individual pack or polybag, and in the case of lenses a standard shelf pack will have

6 to 12 to a container. Refer to your price sheet for exact quantity and other pack types.

### Reference Notes:

For each product listing we have included the latest applicable Federal Motor Vehicle Standards [FMVSS], SAE® code and technical specifications. In this area we have also listed related accessory items such as Pigtails, Brackets and Grommets.

The part numbers listed are suggested items; they may not be the only alternative. However, additional part numbers that may better fit your application can be located in the Pigtail, or Mounting Options Sections.

**PG** = PC lamp rating

**ECE** = ECE - European Certified

**24** = 24 Volts

**MULTI** = Multiple Voltage

**RETAIL** = Retail Packaging

**FOG** = Compliant for SAE J583™ 2004

**MODEL NUMBER INDEX**

| <i>Model No.</i> | <i>Page</i>   | <i>Model No.</i> | <i>Page</i> | <i>Model No.</i> | <i>Page</i> | <i>Model No.</i> | <i>Page</i>   | <i>Model No.</i> | <i>Page</i> |
|------------------|---------------|------------------|-------------|------------------|-------------|------------------|---------------|------------------|-------------|
| 01-5444-75       | 89            | 63E51            | 177         | 64J11            | 180         | 12153            | 227           | 28063            | 227         |
| 01-5445-75       | 89            | 63E71            | 177         | 64J21            | 180         | 12164            | 230           | 28152            | 224         |
| 01-6605-W3       | 239, 241      | 63F21            | 173         | 64J31            | 180         | 12164-5          | 230           | 28162            | 224         |
| 01-6605-W7       | 239, 241      | 63F31            | 173         | 64J61-5          | 161         | 12172            | 225           | 28193            | 226         |
| 01-6605-X4       | 239, 241      | 63F81            | 174         | 64J71-5          | 161         | 12173            | 225           | 28252-5          | 230         |
| 01-6606-X3       | 239, 241      | 63F81-5          | 174         | 64M11-5          | 170         | 12182            | 225           | 28323-5          | 229         |
| 01-6608-E9       | 247           | 63F91            | 174         | 64M21-5          | 171         | 12183            | 225, 226, 227 | 28393-5          | 229         |
| 01-6608-F9       | 247           | 63G01            | 174         | 02001-4          | 164         | 12193-5          | 229           | 28443            | 226         |
| 01-6620-C8       | 237, 239, 241 | 63G11            | 174         | 05001-5          | 165         | 12201-5          | 230           | 28453            | 228         |
| 01-6620-C9       | 237, 239      | 63H01            | 179         | 05041-5          | 165         | 12243-5          | 228           | 28461            | 222         |
| 01-6620-E9       | 241           | 63H11            | 179         | 05051-5          | 165         | 12263-5          | 229           | 28463            | 222         |
| 01-6620-F1       | 241           | 63H31            | 172         | 05301-5          | 165         | 12272-5          | 226           | 28481            | 227         |
| 01-6620-F2       | 241           | 63H81            | 179         | 06001-4          | 165         | 12283            | 225           | 28491            | 227         |
| 01-6620-F3       | 241           | 63J01            | 175         | 06021-4          | 165         | 12293            | 225           | 28493            | 227         |
| 01-6621-A9       | 237, 239      | 63J11            | 175         | 06201            | 165         | 12301            | 228           | 28663            | 224         |
| 01-6621-C1       | 241           | 63J21            | 175         | 07401            | 166         | 12303            | 228           | 28763            | 230         |
| 01-6621-C3       | 241           | 63J31            | 175         | 09561            | 188         | 12312-5          | 231           | 29060            | 223, 231    |
| 01-6621-C7       | 241           | 63L21            | 172         | 09681            | 188         | 12331            | 228           | 40052            | 287         |
| 01-6660-K3       | 237           | 63U01            | 172         | 09781            | 188         | 12333            | 228           | 40052-5          | 287         |
| 01-6660-M6       | 239, 241      | 63U41            | 172         | 09793            | 188         | 12813            | 225           | 40053            | 287         |
| 01-6661-A2       | 239, 241      | 63W01            | 173         | 10002            | 232         | 12983            | 225           | 40062            | 287         |
| 01-6670-L5       | 237           | 63W11            | 173         | 10012            | 232         | 16021            | 221           | 40063            | 287         |
| 01-6693-74       | 237, 239, 241 | 63W21            | 173         | 10013            | 232         | 16023            | 221           | 40072            | 287         |
| 01-6707-A9       | 237, 239, 241 | 63W31            | 173         | 10025            | 232         | 16032            | 225           | 40072-5          | 287         |
| 01-6707-C2       | 241           | 63W41            | 173         | 10045            | 232         | 16033            | 225           | 40073            | 287         |
| 01-6707-C3       | 237, 239      | 63W61            | 173         | 10073            | 232         | 16041            | 222           | 40073-5          | 287         |
| 01-6758-86       | 237, 239, 241 | 63W71            | 173         | 10173            | 233         | 16043            | 222           | 40092            | 288         |
| 01-6758-87       | 237, 239, 241 | 63Z61            | 177         | 10433            | 226         | 16053            | 222           | 40093            | 288         |
| 05-2018-47       | 237, 239, 241 | 63Z71            | 177         | 10623            | 232         | 16091            | 222           | 40132            | 286         |
| 05-2018-93       | 237, 239      | 63Z81            | 177         | 11133            | 233         | 16092            | 222           | 40132-5          | 286         |
| 61E41            | 137           | 64E01            | 178         | 11195            | 227         | 16093            | 222           | 40133            | 286         |
| 61E51            | 135           | 64E01-5          | 178         | 11293            | 233         | 16101            | 222           | 40133-5          | 286         |
| 61E81            | 140           | 64E11            | 178         | 11303            | 233         | 16102            | 222           | 40152            | 288         |
| 61E91            | 140           | 64E11-5          | 178         | 12004            | 230         | 16123            | 222           | 40153            | 288         |
| 61F01            | 140           | 64F11            | 178         | 12004-5          | 230         | 16153            | 222           | 40192            | 288         |
| 61F30            | 136           | 64F71            | 178         | 12010            | 226         | 16202            | 222           | 40193            | 288         |
| 61F51            | 136           | 64G01            | 178         | 12014            | 230         | 16244            | 222           | 40232            | 288         |
| 61F61            | 135           | 64G01-5          | 178         | 12014-5          | 230         | 16273            | 222           | 40232-5          | 288         |
| 61F81            | 140           | 64G11            | 178         | 12020            | 226         | 16284            | 222           | 40233            | 288         |
| 61G01            | 140           | 64G11-5          | 178         | 12052            | 224         | 18302-5          | 231           | 40233-5          | 288         |
| 61G21            | 135           | 64G41            | 178         | 12053            | 224         | 22013            | 223, 231      | 40302            | 286         |
| 61G31            | 26, 141       | 64G51            | 178         | 12071            | 228         | 22193            | 226           | 40303            | 286         |
| 61H01            | 137           | 64G61            | 178         | 12072            | 228         | 22233            | 223, 231      | 40641            | 285         |
| 61H51            | 137           | 64G71            | 178         | 12073            | 228         | 26001-5          | 222           | 40641-5          | 285         |
| 61H91            | 135           | 64H51-4          | 163         | 12073-5          | 228         | 28032            | 224           | 40650            | 285         |
| 61J11            | 135           | 64H51-5          | 163         | 12102            | 229         | 28033            | 224           | 40650-5          | 285         |
| 61M11            | 135           | 64H61-4          | 163         | 12111-5          | 228, 229    | 28033-5          | 224           | 40701            | 285         |
| 61N11            | 135           | 64H61-5          | 163         | 12112-5          | 228         | 28042            | 224           | 41002            | 287         |
| 63E23            | 172           | 64H71-5          | 159         | 12113-5          | 228, 229    | 28043            | 224           | 41003            | 287         |
| 63E41            | 177           | 64H81-5          | 160         | 12122            | 230         | 28051            | 230           | 41012            | 288         |

## MODEL NUMBER INDEX

| <i>Model No.</i> | <i>Page</i>        | <i>Model No.</i> | <i>Page</i>             | <i>Model No.</i> | <i>Page</i> | <i>Model No.</i> | <i>Page</i> | <i>Model No.</i> | <i>Page</i> |
|------------------|--------------------|------------------|-------------------------|------------------|-------------|------------------|-------------|------------------|-------------|
| 41013            | 288                | 43272-5          | 281                     | 44530-5          | 212         | 45412            | 42          | 46132            | 37          |
| 41032            | 286                | 43282            | 279                     | 44540            | 212         | 45412-5          | 42          | 46133            | 37          |
| 41033            | 286                | 43292            | 279                     | 44690            | 212         | 45413            | 42          | 46142            | 39          |
| 41042            | 286                | 43300            | 184, 281                | 44700            | 212         | 45413-5          | 42          | 46143            | 39          |
| 41043            | 286                | 43325            | 280                     | 44710            | 212         | 45432            | 51          | 46282            | 59          |
| 41050            | 285                | 43343            | 106, 275                | 44720            | 212         | 45433            | 51          | 46283            | 59          |
| 41121            | 285                | 43362            | 107, 132, 151, 278, 281 | 44730            | 213         | 45442            | 29, 58      | 46302            | 29, 57      |
| 41122            | 285                | 43380            | 72, 149, 271            | 44810            | 211         | 45443            | 29, 58      | 46303            | 29, 57      |
| 41133            | 285                | 43390            | 72, 149, 273            | 44810-5          | 211         | 45462            | 29, 57      | 46322            | 66          |
| 41142            | 285                | 43411            | 291                     | 44820            | 211         | 45463            | 29, 57      | 46323            | 66          |
| 41143            | 285                | 43424            | 291                     | 44840-5          | 166         | 45503            | 65          | 46332            | 66          |
| 41152            | 285                | 43512            | 71, 150, 269            | 44850            | 212         | 45512            | 48          | 46333            | 66          |
| 41153            | 285                | 43522            | 71, 150, 269            | 44860            | 212         | 45513            | 48          | 46393            | 49          |
| 41160            | 285                | 43532            | 70, 71, 150, 269        | 44890            | 211         | 45573            | 52          | 46393-5          | 49          |
| 42063            | 69, 265            | 43540            | 280                     | 44891            | 211         | 45582            | 52          | 46412            | 44          |
| 42070            | 69, 272            | 43572            | 106, 131, 151, 276      | 44892            | 212         | 45583            | 52          | 46412-5          | 44          |
| 42103            | 278                | 43642            | 106, 132, 276           | 44910            | 147         | 45593            | 52          | 46413            | 44          |
| 42110            | 69, 270            | 43652            | 188, 281                | 45002-5          | 43          | 45603            | 52          | 46413-5          | 44          |
| 42120            | 69, 270            | 43655            | 106, 132, 276           | 45003-5          | 43          | 45623            | 52          | 46422-5          | 44          |
| 42152            | 107, 277           | 43673            | 274                     | 45012            | 59          | 45633            | 52          | 46423-5          | 44          |
| 42153            | 107, 277           | 43684            | 245                     | 45013            | 59          | 45643            | 52          | 46543            | 64          |
| 42162            | 72, 131, 271       | 43690            | 70, 71, 150, 269        | 45022            | 43          | 45662            | 54          | 46543-5          | 64          |
| 42170            | 71, 268            | 43723            | 107, 132, 278           | 45023            | 43          | 45663            | 54          | 46703            | 50          |
| 42180            | 70, 71, 269        | 43732            | 106, 132, 277           | 45042            | 41          | 45712            | 54          | 46712            | 50          |
| 42282            | 69, 272            | 43760            | 70, 71, 269             | 45043            | 41          | 45713            | 54          | 46712-5          | 50          |
| 42292            | 69, 272            | 43780            | 72, 130, 149, 273       | 45062            | 38          | 45763            | 53          | 46713            | 50          |
| 42302            | 69, 272            | 43783            | 72, 130, 149, 273       | 45063            | 38          | 45773            | 52          | 46713-5          | 50          |
| 42312            | 69, 272            | 43790            | 72, 149, 273            | 45072            | 41          | 45793            | 52          | 46740            | 46          |
| 42343            | 69, 266            | 43823            | 71, 268                 | 45073            | 41          | 45811            | 143         | 46742            | 46          |
| 43022            | 280                | 43830            | 131, 272                | 45092            | 46          | 45812            | 41          | 46743            | 46          |
| 43022-5          | 280                | 43842            | 281                     | 45093            | 46          | 45812-5          | 41          | 46782            | 51          |
| 43040            | 70, 131, 267       | 43850            | 72, 130, 149, 273       | 45162            | 44          | 45813            | 41          | 46783            | 51          |
| 43050            | 270                | 43901            | 291                     | 45172            | 59          | 45813-5          | 41          | 46791            | 143         |
| 43074            | 72, 274            | 43952            | 107, 132, 151, 278      | 45173            | 59          | 45821            | 121         | 46792            | 51          |
| 43100            | 132, 279           | 43960            | 72, 131, 271            | 45203            | 38          | 45822            | 38          | 46792-5          | 51          |
| 43120            | 72, 274            | 43962            | 72, 131, 271            | 45232            | 46          | 45822-5          | 38          | 46793            | 51          |
| 43144            | 274                | 43970            | 72, 149, 270            | 45233            | 46          | 45823            | 38          | 46793-5          | 51          |
| 43150            | 70, 150, 266       | 43980            | 72, 149, 270            | 45252            | 48          | 45823-5          | 38          | 46823            | 63          |
| 43152            | 70, 150, 266       | 44010            | 213                     | 45252-5          | 48          | 45832            | 41          | 46832            | 29, 56      |
| 43153            | 70, 150, 266       | 44030            | 213                     | 45253            | 48          | 45833            | 41          | 46833            | 29, 56      |
| 43160            | 71, 150, 268       | 44070            | 213                     | 45253-5          | 48          | 45932            | 50          | 46872            | 29, 56      |
| 43162            | 71, 268            | 44090            | 211                     | 45262            | 50          | 45933            | 50          | 46873            | 29, 56      |
| 43163            | 71, 150, 268       | 44110            | 211                     | 45263            | 50          | 45993            | 65          | 46882            | 49          |
| 43172            | 107, 278           | 44134            | 208                     | 45282            | 30, 36      | 46003            | 63          | 46882-5          | 49          |
| 43220            | 107, 132, 278      | 44242            | 147                     | 45283            | 30, 36      | 46003-5          | 63          | 46883            | 49          |
| 43222            | 107, 132, 278      | 44380            | 147                     | 45302            | 30, 36      | 46072            | 29, 57      | 46883-5          | 49          |
| 43223            | 107, 132, 278      | 44421            | 209                     | 45303            | 30, 36      | 46073            | 29, 57      | 46892            | 60          |
| 43253            | 106, 131, 151, 275 | 44440            | 147                     | 45322            | 43          | 46082            | 29, 57      | 46892-5          | 60          |
| 43262-5          | 280                | 44460            | 213                     | 45323            | 43          | 46083            | 29, 57      | 46893            | 60          |
| 43272            | 281                | 44530            | 212                     | 45333            | 64          | 46092            | 58          | 46893-5          | 60          |



**MODEL NUMBER INDEX**

| <i>Model No.</i> | <i>Page</i>  | <i>Model No.</i> | <i>Page</i> | <i>Model No.</i> | <i>Page</i> | <i>Model No.</i> | <i>Page</i>   | <i>Model No.</i> | <i>Page</i> |
|------------------|--------------|------------------|-------------|------------------|-------------|------------------|---------------|------------------|-------------|
| 46913            | 64           | 47493            | 45          | 49281            | 32, 35      | 51002            | 19, 79        | 52770            | 22, 78      |
| 46933            | 48           | 47502            | 46          | 49282            | 32, 35      | 51012            | 19, 79        | 52772            | 22, 78      |
| 46982-5          | 49, 112      | 47503            | 46          | 49283            | 32, 35      | 51022            | 23, 80        | 52773            | 22, 78      |
| 46983-5          | 49, 112, 113 | 47732            | 54          | 49322            | 32, 35      | 51032            | 23, 80        | 52782            | 22, 78      |
| 47012            | 43           | 47733            | 54          | 49322-5          | 35          | 51052            | 23, 79        | 52802            | 95          |
| 47013            | 43           | 47772            | 52          | 49323            | 32, 35      | 51090            | 106, 132, 276 | 52812            | 95          |
| 47052            | 49           | 47773            | 52          | 49323-5          | 35          | 51962            | 111           | 52822            | 96          |
| 47053            | 49           | 47853-5          | 111         | 49332            | 32, 35      | 51962-5          | 111           | 52832            | 96          |
| 47063            | 64           | 47913            | 53          | 49333            | 32, 35      | 51972-5          | 111           | 52892            | 27, 85      |
| 47072            | 28, 55       | 47922            | 53          | 49341            | 32, 35      | 51982            | 111           | 52893            | 27, 85      |
| 47073            | 28, 55       | 47923            | 53          | 49342            | 32, 35      | 51982-5          | 111           | 52902            | 94          |
| 47082            | 44           | 47952            | 36          | 49343            | 32, 35      | 51992            | 111           | 52912            | 94          |
| 47083            | 44           | 47952-5          | 36          | 49351            | 32, 35      | 51992-5          | 111           | 52922            | 23, 79      |
| 47084            | 44           | 47953            | 30, 36      | 49352            | 32, 35      | 52023            | 88            | 52922-5          | 23, 79      |
| 47092            | 45           | 47953-5          | 36          | 49353            | 32, 35      | 52063            | 88            | 52923            | 23, 79      |
| 47093            | 45           | 47962            | 30, 36      | 49362            | 33, 35      | 52072            | 24, 83        | 52972            | 96          |
| 47102            | 39           | 47963            | 30, 36      | 49363            | 33, 35      | 52073            | 25, 83        | 53000            | 100         |
| 47103            | 39           | 47972            | 31, 36      | 49372            | 31, 36      | 52092            | 18, 75        | 53012            | 23, 79      |
| 47112            | 37           | 47973            | 31, 36      | 49373            | 31, 36      | 52093            | 19, 75        | 53012-5          | 23, 79      |
| 47113            | 37           | 47982            | 30, 36      | 49382            | 31, 36      | 52152            | 22, 78        | 53020            | 100         |
| 47122            | 39           | 47983            | 30, 36      | 49383            | 31, 36      | 52162            | 20, 76        | 53023            | 100         |
| 47123            | 39           | 48072            | 216         | 49392            | 28, 55      | 52163            | 20, 76        | 53062            | 29, 88      |
| 47162            | 28, 55       | 48132            | 218         | 49393            | 28, 55      | 52182            | 27, 86        | 53063            | 29, 88      |
| 47163            | 28, 55       | 48272            | 216         | 49412            | 32, 35      | 52182-5          | 27, 86        | 53082-5          | 27, 114     |
| 47183            | 63           | 48282            | 216         | 49413            | 32, 35      | 52183            | 27, 86        | 53092            | 27, 86      |
| 47202            | 39           | 48283            | 219         | 49452            | 32, 35      | 52193            | 27, 87        | 53093            | 27, 86      |
| 47212            | 38           | 48442            | 219         | 49453            | 32, 35      | 52202            | 90            | 53102            | 22, 78      |
| 47213            | 38           | 48522            | 217         | 49460            | 31, 36      | 52203            | 90            | 53103            | 22, 78      |
| 47222            | 42           | 48532            | 217         | 49501-3          | 170, 171    | 52253            | 27, 87        | 53112            | 22, 78      |
| 47223            | 42           | 48552            | 218         | 49511-3          | 170, 171    | 52302            | 113           | 53122            | 25, 83      |
| 47232            | 40           | 49062            | 62          | 50132            | 103         | 52302-5          | 113           | 53123            | 25, 83      |
| 47233            | 40           | 49072            | 63          | 50222            | 23, 80      | 52312            | 113           | 53132            | 90          |
| 47242            | 47           | 49082            | 63          | 50232            | 23, 81      | 52312-5          | 113           | 53133            | 90          |
| 47243            | 47           | 49112            | 62          | 50232-5          | 23, 81      | 52362            | 115           | 53163            | 29, 88      |
| 47252            | 53           | 49112-5          | 62          | 50352            | 101         | 52372            | 115           | 53182            | 20, 76      |
| 47253            | 53           | 49122            | 61          | 50502            | 23, 81      | 52423            | 26, 87        | 53192            | 20, 76      |
| 47262            | 53           | 49132            | 61          | 50630            | 101         | 52442            | 113           | 53252            | 18, 75      |
| 47263            | 53           | 49142            | 60          | 50642            | 101         | 52452            | 113           | 53253            | 19, 75      |
| 47322            | 39           | 49162            | 60          | 50820            | 22, 80      | 52482            | 115           | 53272            | 18, 75      |
| 47323            | 39           | 49172            | 61          | 50852            | 97          | 52492            | 115           | 53282            | 18, 75      |
| 47332            | 37           | 49182            | 60          | 50862            | 97          | 52513            | 27, 87        | 53292            | 18, 75      |
| 47333            | 37           | 49192            | 62          | 50872            | 97          | 52522            | 23, 81        | 53293            | 19, 75      |
| 47362            | 47           | 49202            | 31, 61      | 50882            | 97          | 52533            | 27, 87        | 53302            | 18, 75      |
| 47372            | 40           | 49212-5          | 62          | 50892            | 97          | 52562            | 27, 85        | 53303            | 19, 75      |
| 47373            | 40           | 49223            | 62          | 50902            | 94          | 52563            | 27, 85        | 53312            | 20, 76      |
| 47462            | 47           | 49242-5          | 62          | 50912            | 94          | 52572            | 27, 85        | 53313            | 20, 76      |
| 47463            | 47           | 49252            | 47          | 50920            | 91          | 52592-5          | 26, 85, 89    | 53413            | 20, 76      |
| 47472            | 39           | 49253            | 47          | 50972            | 95          | 52602            | 96            | 53422            | 102         |
| 47473            | 39           | 49262            | 32, 35      | 50972-5          | 95          | 52672            | 22, 78        | 53432            | 19, 75      |
| 47492            | 45           | 49263            | 32, 35      | 50992            | 94          | 52682            | 22, 78        | 53462            | 19, 75      |

## MODEL NUMBER INDEX

| <i>Model No.</i> | <i>Page</i> | <i>Model No.</i> | <i>Page</i> | <i>Model No.</i> | <i>Page</i>  | <i>Model No.</i> | <i>Page</i> | <i>Model No.</i> | <i>Page</i> |
|------------------|-------------|------------------|-------------|------------------|--------------|------------------|-------------|------------------|-------------|
| 53532            | 18, 75      | 54333            | 20, 77      | 56170            | 98           | 61091            | 139         | 62691            | 21, 124     |
| 53552            | 18, 75      | 54342            | 21, 78      | 56180            | 98           | 61111            | 135         | 62751            | 26, 126     |
| 53553            | 19, 75      | 54342-5          | 78          | 60001            | 122          | 61121            | 138         | 62791            | 20, 124     |
| 53582            | 89          | 54343            | 21, 78      | 60011            | 122          | 61141            | 138         | 63151-5          | 186         |
| 53592            | 24, 83      | 54362            | 19, 77      | 60011-5          | 122          | 61161            | 139         | 63171-5          | 186         |
| 53593            | 25, 83      | 54363            | 20, 77      | 60081            | 122          | 61171            | 137         | 63181-5          | 187         |
| 53622            | 24, 83      | 54472            | 19, 77      | 60101            | 145          | 61221            | 141         | 63241-5          | 186         |
| 53630            | 91          | 54482            | 19, 77      | 60101-5          | 145          | 61261            | 135         | 63251-5          | 187         |
| 53640            | 91          | 54492            | 19, 77      | 60121            | 122          | 61281            | 140         | 63391            | 163         |
| 53650            | 91          | 54493            | 20, 77      | 60151            | 146          | 61291            | 135         | 63451-4          | 163         |
| 53662            | 112         | 54562            | 20, 76      | 60151-5          | 146          | 61301            | 141         | 63531            | 164         |
| 53672            | 112         | 54573            | 19          | 60191            | 121          | 61451            | 23, 139     | 63551            | 184         |
| 53702            | 92          | 54593            | 58          | 60251            | 145          | 61491-5          | 141         | 63561            | 19, 186     |
| 53712            | 92          | 54602            | 19, 77      | 60251-5          | 145          | 61501            | 146         | 63571            | 177         |
| 53722            | 93          | 54622            | 18, 75      | 60261            | 121          | 61501-5          | 146         | 63581            | 177         |
| 53762            | 93          | 54643            | 20, 77      | 60271            | 142          | 61611            | 135         | 63591            | 177         |
| 53782            | 93          | 54663            | 58          | 60280            | 121          | 61793            | 140         | 63601            | 176         |
| 53792            | 93          | 54672            | 24, 82      | 60291            | 121          | 61811            | 139         | 63601-5          | 176         |
| 53883            | 102         | 54682            | 24, 82      | 60301            | 142          | 61821            | 139         | 63602            | 176         |
| 53962            | 24, 83      | 54702            | 24, 82      | 60311            | 128          | 61851            | 138         | 63610            | 176         |
| 53963            | 25, 83      | 54722            | 24, 82      | 60321            | 120          | 61851-5          | 138         | 63611            | 176         |
| 53972            | 24, 83      | 54752            | 24, 82      | 60331            | 29, 120      | 61861            | 136         | 63611-5          | 176         |
| 53973            | 25, 83      | 54762            | 24, 82      | 60341            | 120          | 61871            | 136         | 63621            | 176         |
| 54002            | 28, 89      | 54792            | 83          | 60351            | 143          | 61881            | 135         | 63621-5          | 176         |
| 54003            | 28, 56, 89  | 54802            | 24, 83      | 60361            | 144          | 61931            | 136         | 63731            | 176         |
| 54012            | 29, 88      | 55103            | 20, 76      | 60381            | 120          | 61991            | 136         | 63741            | 176         |
| 54032            | 18, 75      | 55162            | 18, 76      | 60411            | 142          | 62011            | 127         | 63741-5          | 176         |
| 54042            | 19, 75      | 55202            | 18, 76      | 60421            | 142          | 62021            | 127         | 63751            | 176         |
| 54132            | 25, 83      | 55212            | 18          | 60460            | 121          | 62051            | 26, 125     | 63751-5          | 176         |
| 54133            | 25, 83      | 55220            | 101         | 60481            | 146          | 62091            | 20, 124     | 63821            | 179, 184    |
| 54142            | 25, 83      | 55223            | 101         | 60561            | 143          | 62101            | 20, 124     | 63821-5          | 179         |
| 54143            | 25, 83      | 55280            | 100         | 60571            | 144          | 62121            | 22, 124     | 63831            | 179, 184    |
| 54162            | 26, 84      | 55290            | 100         | 60581            | 140          | 62151            | 127         | 63831-5          | 179         |
| 54163            | 26, 84      | 55340            | 99          | 60591            | 140          | 62171            | 22, 124     | 63861            | 179         |
| 54172            | 26, 84      | 55410            | 99          | 60631            | 20, 122      | 62181            | 23, 124     | 63861-5          | 179         |
| 54173            | 26, 84      | 55420            | 99          | 60651            | 33, 119      | 62211            | 22, 123     | 63871            | 179         |
| 54183            | 25, 86      | 55450            | 99          | 60661            | 33, 119      | 62231            | 27, 126     | 63871-5          | 179         |
| 54193            | 25, 86      | 55460            | 99          | 60671            | 33, 119      | 62251            | 27, 126     | 63921            | 185         |
| 54203            | 25, 86      | 55470            | 98          | 60681            | 33, 119      | 62271            | 22, 123     | 63941            | 185         |
| 54213            | 25, 86      | 55982            | 102         | 60691            | 33, 119      | 62291            | 128         | 63971            | 179         |
| 54223            | 86          | 55983            | 102         | 60701            | 33, 119      | 62321            | 22, 124     | 63981            | 172         |
| 54233            | 86          | 55992            | 102         | 60711            | 33, 119      | 62331            | 22, 123     | 63981-5          | 172         |
| 54243            | 25, 86      | 55993            | 102         | 60721            | 33, 119, 144 | 62381            | 127         | 63991            | 172         |
| 54253            | 25, 86      | 56000            | 100         | 60721-5          | 119          | 62391            | 20, 123     | 63991-5          | 172         |
| 54263            | 25, 86      | 56020            | 100         | 60781            | 33, 119      | 62401            | 20, 123     | 64021            | 185         |
| 54282            | 21          | 56072            | 103         | 60824            | 33, 37       | 62521            | 27, 126     | 64101            | 184         |
| 54292            | 19          | 56073            | 103         | 60831            | 33, 35       | 62561            | 25, 125     | 64111            | 184         |
| 54302            | 19          | 56083            | 103         | 60861            | 33, 119      | 62571            | 20, 123     | 64241            | 162         |
| 54313            | 19          | 56150            | 98          | 61031            | 136          | 62591            | 25, 125     | 64251            | 162         |
| 54332            | 19, 77      | 56160            | 98          | 61051            | 23, 139      | 62601            | 25, 125     | 64261-4          | 162         |

**MODEL NUMBER INDEX**

| <i>Model No.</i> | <i>Page</i> | <i>Model No.</i> | <i>Page</i>        | <i>Model No.</i> | <i>Page</i>        | <i>Model No.</i> | <i>Page</i> | <i>Model No.</i> | <i>Page</i> |
|------------------|-------------|------------------|--------------------|------------------|--------------------|------------------|-------------|------------------|-------------|
| 64291-4          | 162         | 66154            | 251                | 66851            | 67, 129, 148, 256  | 68060            | 260         | 76943            | 200         |
| 64341            | 185         | 66155            | 251                | 66860            | 105, 262           | 68130            | 263         | 76953            | 200         |
| 64371-5          | 164         | 66160            | 249                | 66861            | 105, 188, 261      | 68150            | 263         | 76980            | 200         |
| 64441            | 184         | 66161            | 249                | 66862            | 105, 261           | 68170            | 149, 263    | 76983            | 200         |
| 64471            | 185         | 66162            | 249                | 66863            | 105, 262           | 68380            | 263         | 76985            | 200         |
| 64611            | 186         | 66163            | 249                | 66864            | 105, 262           | 68420            | 117         | 76993            | 200         |
| 64890            | 186         | 66164            | 250                | 66865            | 105, 262           | 68540-5          | 117         | 77012            | 196         |
| 64891            | 186         | 66165            | 251                | 66870            | 67, 258            | 68580            | 188, 260    | 77013            | 196         |
| 64901            | 187         | 66170            | 248                | 66900            | 68, 257            | 68630            | 159, 160    | 77101            | 196         |
| 64921            | 184         | 66171            | 250                | 66902            | 68, 257            | 68680            | 261         | 77102            | 196         |
| 64930            | 184, 282    | 66190            | 249                | 66904            | 68, 257            | 69680            | 217         | 77103            | 196         |
| 64931            | 184         | 66200            | 250                | 66905            | 68, 257            | 69690            | 217         | 77105            | 196         |
| 64931-5          | 184         | 66203            | 237, 239, 241      | 66910            | 68, 129, 257       | 71152            | 293         | 77193            | 20, 203     |
| 64940            | 185         | 66220            | 250                | 66911            | 68, 129, 257       | 71422            | 292         | 77203            | 197         |
| 64941            | 185         | 66221            | 237, 239, 241, 250 | 66930            | 67, 256, 265       | 71440            | 293         | 77223            | 200         |
| 65202            | 45          | 66222            | 237, 239, 241, 250 | 66931            | 67, 256            | 72010-5          | 208         | 77351            | 20, 204     |
| 65203            | 45          | 66223            | 248                | 66932            | 67, 260            | 72100-5          | 208         | 77352            | 20, 204     |
| 65230-5          | 112         | 66224            | 248                | 66980            | 67, 129, 148, 256  | 72110-5          | 208         | 77353            | 20, 204     |
| 65300-5          | 115         | 66360            | 68, 257            | 66981            | 67, 129, 148, 256  | 73030            | 207         | 77355            | 20, 204     |
| 65320-5          | 111         | 66402            | 237, 239           | 66982            | 67, 129, 148, 256  | 73040            | 206         | 77361            | 204         |
| 65330-5          | 111         | 66403            | 241                | 67000            | 104, 130, 259      | 73040-5          | 206         | 77362            | 204         |
| 65370-5          | 113         | 66601            | 237                | 67001            | 67, 129, 148, 256  | 73070            | 207         | 77363            | 204         |
| 65380-5          | 113         | 66650            | 205                | 67002            | 68, 104, 258       | 73080            | 207         | 77365            | 204         |
| 65390-5          | 114         | 66660            | 205                | 67005            | 68, 104, 258       | 73090            | 206         | 77461            | 202         |
| 65402-4          | 23, 116     | 66670            | 205                | 67006            | 105, 262           | 73110            | 206         | 77462            | 202         |
| 65432-4          | 19, 115     | 66705            | 246                | 67010            | 105, 130, 148, 260 | 73140-5          | 208         | 77463            | 202         |
| 65440-5          | 112         | 66800            | 67, 129, 148, 256  | 67011            | 105, 130, 148, 260 | 73150-5          | 208         | 77465            | 202         |
| 65512            | 47          | 66801            | 67, 129, 148, 256  | 67013            | 104, 130, 148, 258 | 73160            | 207         | 77473            | 195         |
| 65513            | 47          | 66810            | 105, 261           | 67014            | 105, 130, 148, 260 | 73170            | 207         | 77483            | 195         |
| 65720-5          | 116         | 66811            | 104, 130, 259      | 67016            | 104, 130, 148, 259 | 73220            | 207         | 77803            | 200         |
| 65730-5          | 116         | 66812            | 104, 130, 259      | 67020            | 105, 130, 148, 260 | 73240            | 206         | 77813            | 194         |
| 65880-5          | 111         | 66813            | 105, 261           | 67050            | 67, 129, 148, 256  | 73250            | 206         | 77823            | 194         |
| 66071            | 246         | 66814            | 105, 261           | 67050-5          | 67, 129, 148, 256  | 73310            | 207         | 77833            | 194         |
| 66100            | 249         | 66815            | 68, 104, 258       | 67070            | 68, 129, 257       | 73350            | 206         | 77843            | 194         |
| 66101            | 249         | 66816            | 68, 104, 129, 258  | 67071            | 68, 129, 257       | 73360            | 206         | 77912            | 197         |
| 66110            | 249         | 66820            | 105, 262           | 67090            | 104, 259           | 73370            | 206         | 77913            | 197         |
| 66111            | 67, 260     | 66823            | 105, 262           | 67090-5          | 104, 259           | 76033            | 198         | 77923            | 197         |
| 66113            | 249, 251    | 66825            | 104, 259           | 67120            | 149, 257           | 76083            | 197         | 77931            | 202         |
| 66121            | 250         | 66826            | 261                | 67250            | 248                | 76203            | 198         | 77933            | 202         |
| 66122            | 249         | 66830            | 104, 262           | 67260            | 248                | 76223            | 198         | 77953            | 192         |
| 66123            | 249         | 66831            | 104, 262           | 67271            | 248                | 76253            | 192         | 77963            | 192         |
| 66124            | 249         | 66836            | 104, 262           | 67301            | 248                | 76263            | 192         | 78003            | 103         |
| 66125            | 249         | 66840            | 67, 129, 148, 256  | 67570            | 247                | 76683            | 193         | 78010            | 191         |
| 66133            | 250         | 66841            | 68, 104, 258       | 67571            | 247                | 76685            | 193         | 78011            | 191         |
| 66135            | 251         | 66842            | 104, 130, 148, 258 | 67580            | 247                | 76693            | 193         | 78013            | 191         |
| 66145            | 250         | 66843            | 104, 259           | 67581            | 247                | 76770            | 200         | 78015            | 191         |
| 66150            | 251         | 66844            | 104, 259           | 67760            | 180                | 76792            | 203         | 78020            | 199         |
| 66151            | 251         | 66845            | 68, 104, 258       | 68010            | 188, 260           | 76793            | 203         | 78023            | 199         |
| 66152            | 251         | 66846            | 104, 130, 148, 259 | 68020            | 260                | 76793-5          | 203         | 78024            | 199         |
| 66153            | 251         | 66850            | 67, 129, 148, 256  | 68030            | 260                | 76795            | 203         | 78025            | 199         |



## MODEL NUMBER INDEX

| <i>Model No.</i> | <i>Page</i> | <i>Model No.</i> | <i>Page</i> | <i>Model No.</i> | <i>Page</i> | <i>Model No.</i> | <i>Page</i>  | <i>Model No.</i> | <i>Page</i>             |
|------------------|-------------|------------------|-------------|------------------|-------------|------------------|--------------|------------------|-------------------------|
| 78030            | 192         | 78162            | 201         | 79100            | 201         | 90013            | 108          | 91581            | 108, 133                |
| 78031            | 192         | 78163            | 201         | 79110            | 201         | 90062            | 73           | 91582            | 108                     |
| 78032            | 192         | 78163-1          | 201         | 79120            | 201         | 90063            | 73           | 91583            | 108                     |
| 78033            | 192         | 78164            | 201         | 79133            | 199         | 90072            | 73           | 91683            | 73                      |
| 78034            | 192         | 78165            | 201         | 79143            | 199         | 90073            | 73           | 91740            | 106, 131, 151, 274      |
| 78035            | 192         | 78190            | 204         | 79153            | 199         | 90103            | 108          | 91880            | 71, 150, 267            |
| 78041            | 192         | 78191            | 204         | 82080            | 136         | 90122            | 73           | 91890            | 71, 150, 268            |
| 78043            | 192         | 78193            | 204         | 84611-5          | 163         | 90123            | 73           | 91950            | 106, 131, 275           |
| 78045            | 192         | 78194            | 204         | 84621-5          | 163         | 90152            | 73           | 91961            | 151                     |
| 78050            | 192         | 78195            | 204         | 84631-5          | 162         | 90153            | 73           | 91962            | 73                      |
| 78051            | 192         | 78200            | 205         | 84641-5          | 162         | 90162            | 73           | 91963            | 73                      |
| 78052            | 192         | 78210            | 205         | 84651-4          | 163         | 90163            | 73           | 91964            | 73                      |
| 78053            | 192         | 78270            | 205         | 84661-4          | 162         | 90172            | 73           | 92062            | 108                     |
| 78054            | 192         | 78303            | 103         | 87020            | 243         | 90173            | 73           | 92063            | 108                     |
| 78055            | 192         | 78313            | 103         | 87023            | 243         | 90202            | 73           | 92070            | 71, 150, 267            |
| 78061            | 194         | 78333            | 38          | 87100            | 243         | 90203            | 73           | 92120            | 70, 150, 266            |
| 78063            | 194         | 78343            | 41          | 87101            | 243         | 90221            | 133          | 92150            | 70, 150, 266            |
| 78065            | 194         | 78363            | 29, 56      | 87103            | 243         | 90232            | 108          | 92183            | 73                      |
| 78070            | 193         | 78370            | 205         | 87104            | 243         | 90233            | 108          | 92193            | 73                      |
| 78071            | 193         | 78380            | 205         | 87105            | 243         | 90252            | 108          | 92420            | 107, 132, 151, 277      |
| 78075            | 193         | 78393            | 46          | 87110            | 243         | 90303            | 73           | 92432            | 73                      |
| 78080            | 193         | 78403            | 28, 55      | 87111            | 243         | 90342            | 117          | 92433            | 73                      |
| 78081            | 193         | 78410            | 205         | 87112            | 243         | 90353            | 209          | 92510            | 106, 131, 132, 151, 275 |
| 78085            | 193         | 78423            | 39          | 87141            | 244         | 90373            | 209          | 92511            | 106, 131, 151, 275      |
| 78091            | 195         | 78433            | 37          | 87151            | 244         | 90401            | 151          | 92512            | 106, 131, 151, 275      |
| 78092            | 195         | 78443            | 199         | 87170            | 243         | 90482            | 108          | 92513            | 106, 131, 151, 275      |
| 78093            | 195         | 78453            | 47          | 87171            | 243         | 90483            | 108          | 92583            | 273                     |
| 78094            | 195         | 78460            | 201         | 87172            | 243         | 90652            | 115, 117     | 92720            | 107, 132, 151, 277      |
| 78095            | 195         | 78460-5          | 201         | 87173            | 243         | 90762            | 108          | 92773            | 73                      |
| 78101            | 195         | 78513            | 201         | 87180            | 243         | 90922            | 73           | 92792            | 117                     |
| 78102            | 195         | 78563            | 203         | 87181            | 243         | 90923            | 73           | 92920            | 71, 267                 |
| 78103            | 195         | 78573            | 203         | 87182            | 243         | 90941-5          | 159          | 93190            | 276                     |
| 78104            | 195         | 78851            | 194         | 87190            | 243         | 90951-5          | 160          | 93400            | 271                     |
| 78105            | 195         | 78853            | 194         | 87191            | 243         | 90971-5          | 166          | 93402            | 271                     |
| 78113            | 196         | 78855            | 194         | 87192            | 243         | 91042            | 73           | 93453            | 273                     |
| 78122            | 195         | 78861            | 194         | 87193            | 243         | 91043            | 73           | 93552            | 106, 131, 275           |
| 78123            | 195         | 78863            | 194         | 87210            | 246         | 91051            | 166          | 93553            | 106, 131, 275           |
| 78125            | 195         | 78865            | 194         | 87211            | 246         | 91112            | 117          | 93600            | 280                     |
| 78130            | 199         | 79033            | 202         | 87212            | 246         | 91113            | 117          | 93610            | 122                     |
| 78133            | 199         | 79033-5          | 202         | 87214            | 246         | 91122            | 117          | 93670            | 71, 268                 |
| 78135            | 199         | 79043            | 200         | 87215            | 246         | 91302            | 108          | 93683            | 106, 131, 275           |
| 78140            | 201         | 79053            | 199         | 87220            | 244         | 91380            | 72, 149, 270 | 93750            | 71, 268                 |
| 78141            | 201         | 79060            | 199         | 87240            | 244         | 91400            | 71, 150, 267 | 93760            | 70, 266                 |
| 78142            | 201         | 79070            | 191         | 87250            | 244         | 91410            | 71, 150, 267 | 93803            | 69, 271                 |
| 78143            | 201         | 79071            | 191         | 87270            | 244         | 91482            | 108          | 93982            | 279                     |
| 78144            | 201         | 79073            | 191         | 87590            | 245         | 91502            | 108          | 94000            | 71, 267                 |
| 78145            | 201         | 79074            | 191         | 87830            | 245         | 91503            | 108          | 94010            | 71, 267                 |
| 78146            | 201         | 79075            | 191         | 87860            | 244         | 91513            | 108          | 94100            | 70, 150, 266            |
| 78153            | 102         | 79080            | 201         | 90011            | 133         | 91572            | 73           | 94110            | 277                     |
| 78161            | 201         | 79093            | 193         | 90012            | 108         | 91573            | 73           | 94180            | 132, 279                |

**MODEL NUMBER INDEX**

| <i>Model No.</i> | <i>Page</i>       | <i>Model No.</i> | <i>Page</i> | <i>Model No.</i> | <i>Page</i> | <i>Model No.</i> | <i>Page</i> | <i>Model No.</i> | <i>Page</i> |
|------------------|-------------------|------------------|-------------|------------------|-------------|------------------|-------------|------------------|-------------|
| 94233            | 72, 270           | 98314            | 209         | 99842            | 108         | G1093            | 41          | G5082-5          | 92          |
| 94350            | 69, 273           | 98315            | 209         | 99843            | 108         | G1502            | 44          | G5092            | 92          |
| 94360            | 69, 106, 107, 265 | 98333            | 205         | 99912            | 73, 108     | G1503            | 44          | G5092-5          | 92          |
| 94401-5          | 161               | 98350            | 283         | 99913            | 73          | G1902            | 45          | G5202            | 92          |
| 94411-5          | 161               | 98360            | 283         | BZ101-5          | 183         | G1902-5          | 45          | G5212            | 92          |
| 94421-5          | 161               | 98373            | 209         | BZ111-5          | 183         | G1903            | 45          | G5300            | 100         |
| 94450            | 188               | 98383            | 209         | BZ201-5          | 183         | G2102            | 29, 55      | G5530            | 98          |
| 94690            | 188, 282          | 98390            | 283         | BZ301-5          | 183         | G2103            | 29, 55      | G5540            | 98          |
| 97942            | 202               | 98400            | 283         | BZ401-5          | 182         | G3002            | 37          | G5543-5          | 98          |
| 97943            | 202               | 98410            | 283         | BZ501-5          | 182         | G3002-5          | 37          | G6002            | 26, 84      |
| 98130            | 282               | 98460            | 282         | BZ511-5          | 182         | G3003            | 37          | G6002-5          | 26, 84      |
| 98160            | 180               | 98470            | 282         | BZ551-5          | 183         | G3003-5          | 37          | G6003            | 26, 84      |
| 98171            | 209               | 98480            | 283         | BZ601-5          | 183         | G3092            | 38          | G6012            | 26, 84      |
| 98173            | 209               | 98513            | 193, 209    | BZ701            | 182         | G3093            | 38          | G6013            | 26, 84      |
| 98175            | 209               | 98522            | 205         | BZ702            | 182         | G4002            | 21, 77      | G6121            | 145         |
| 98221            | 209               | 99170            | 292         | BZ703            | 182         | G4002-5          | 21, 77      | G6121-5          | 145         |
| 98223            | 209               | 99170-1          | 292         | BZ705            | 182         | G4003            | 21, 77      | G6131            | 145         |
| 98225            | 209               | 99170-GT         | 292         | BZ801-5          | 182         | G4012            | 21, 77      | G6131-5          | 145         |
| 98251            | 209               | 99180            | 292         | BZ901-5          | 182         | G4022            | 21, 77      | G6151            | 146         |
| 98253            | 209               | 99460-5          | 116         | G1002            | 40          | G4023            | 21          | G6151-5          | 146         |
| 98255            | 209               | 99500-3          | 248         | G1003            | 40          | G4502            | 90          | G6261            | 144         |
| 98271            | 209               | 99501-3          | 248         | G1032            | 40          | G4503            | 90          | G6261-5          | 144         |
| 98281            | 209               | 99510            | 244, 245    | G1032-5          | 40          | G4602            | 51          |                  |             |
| 98282            | 209               | 99580            | 291         | G1033            | 40          | G4602-5          | 51          |                  |             |
| 98283            | 209               | 99593            | 106, 277    | G1033-5          | 40          | G4603            | 51          |                  |             |
| 98284            | 209               | 99595            | 106, 277    | G1042            | 40          | G4603-5          | 51          |                  |             |
| 98285            | 209               | 99630            | 208, 244    | G1043            | 40          | G5052            | 65          |                  |             |
| 98293            | 209               | 99680            | 244, 245    | G1082            | 42          | G5053            | 65          |                  |             |
| 98311            | 209               | 99802            | 73          | G1083            | 42          | G5053-5          | 65          |                  |             |
| 98313            | 209               | 99803            | 73          | G1092            | 41          | G5082            | 92          |                  |             |

## MULTI-VOLT AND NON 12-VOLT PRODUCT INDEX

| <i>Model No.</i> | <i>Page</i> | <i>Model No.</i> | <i>Page</i> | <i>Model No.</i> | <i>Page</i>     | <i>Model No.</i> | <i>Page</i> | <i>Model No.</i> | <i>Page</i> |
|------------------|-------------|------------------|-------------|------------------|-----------------|------------------|-------------|------------------|-------------|
| 61E91            | 24V 140     | 64H71-5          | 12-30V 159  | 63241-5          | 24V 186         | 77012            | 12-110V 196 | 78140            | 12-24V 201  |
| 61F30            | 10-32V 136  | 64H81-5          | 12-30V 160  | 63251-5          | 24V 187         | 77013            | 12-110V 196 | 78141            | 12-24V 201  |
| 63E23            | 12/24V 172  | 64J11            | 12/24V 180  | 63571            | 12/24V 177      | 77101            | 11-80V 196  | 78142            | 12-24V 201  |
| 63E41            | 12/24V 177  | 64J21            | 12/24V 180  | 63581            | 12/24V 177      | 77102            | 11-80V 196  | 78143            | 12-24V 201  |
| 63E51            | 12/24V 177  | 64J31            | 12/24V 180  | 63591            | 12/24V 177      | 77103            | 11-80V 196  | 78144            | 12-24V 201  |
| 63E71            | 24V 177     | 64J61-5          | 12-30V 161  | 63731            | 24V 176         | 77105            | 11-80V 196  | 78145            | 12-24V 201  |
| 63F31            | 24V 173     | 64J71-5          | 12-30V 161  | 63741            | 24V 176         | 77203            | 12-80V 197  | 78146            | 12-24V 201  |
| 63F51            | 24V 173     | 64M11-5          | 12/24V 170  | 63741-5          | 24V 176         | 77931            | 10-16V 202  | 78190            | 12-24V 204  |
| 63F61            | 24V 173     | 64M21-5          | 12/24V 171  | 63751            | 24V 176         | 77933            | 10-16V 202  | 78191            | 12-24V 204  |
| 63F81            | 12/24V 174  | 44010            | 12-24V 213  | 63751-5          | 24V 176         | 77963            | 24V 192     | 78193            | 12-24V 204  |
| 63F81-5          | 12/24V 174  | 44030            | 12-24V 213  | 63821            | 12/24V 179, 184 | 78010            | 12-24V 191  | 78194            | 12-24V 204  |
| 63F91            | 12/24V 174  | 44070            | 18-32V 213  | 63821-5          | 12/24V 179      | 78011            | 12-24V 191  | 78195            | 12-24V 204  |
| 63G01            | 12/24V 174  | 44134            | 12-36V 208  | 63831            | 12/24V 179      | 78013            | 12-24V 191  | 78460            | 12-24V 201  |
| 63G11            | 12/24V 174  | 44421            | 12-80V 209  | 63831-5          | 12/24V 179      | 78015            | 12-24V 191  | 78851            | 12-24V 194  |
| 63H01            | 12/24V 179  | 44850            | 24V 212     | 63861            | 12/24V 179      | 78020            | 12-24V 199  | 78853            | 12-24V 194  |
| 63H11            | 12/24V 179  | 44860            | 24V 212     | 63861-5          | 12/24V 179      | 78023            | 12-24V 199  | 78855            | 12-24V 194  |
| 63H31            | 48V 172     | 45162            | 24V 44      | 63871            | 12/24V 179      | 78024            | 12-24V 199  | 79033            | 12-24V 202  |
| 63H81            | 12/24V 179  | 47322            | 24V 39      | 63871-5          | 12/24V 179      | 78025            | 12-24V 199  | 79043            | 12-24V 200  |
| 63J01            | 12/24V 175  | 47323            | 24V 39      | 63971            | 12/24V 179      | 78030            | 12-24V 192  | 79053            | 12-24V 199  |
| 63J11            | 12/24V 175  | 47332            | 24V 37      | 63981            | 12/24V 172      | 78031            | 12-24V 192  | 79070            | 12-24V 191  |
| 63J21            | 12/24V 175  | 47333            | 24V 37      | 63981-5          | 12/24V 172      | 78032            | 12-24V 192  | 79071            | 12-24V 191  |
| 63J31            | 12/24V 175  | 47362            | 24V 47      | 63991            | 12/24 172       | 78034            | 12-24V 192  | 79073            | 12-24V 191  |
| 63W01            | 9-32V 173   | 47732            | 24V 54      | 63991-5          | 12/24V 172      | 78035            | 12-24V 192  | 79074            | 12-24V 191  |
| 63W11            | 9-32V 173   | 47733            | 24V 54      | 64921            | 24V 184         | 78050            | 12-24V 192  | 79075            | 12-24V 191  |
| 63W21            | 9-32V 173   | 49262            | 9-32V 35    | 73030            | 12-24V 207      | 78051            | 12-24V 192  | 79080            | 12-24V 201  |
| 63W31            | 9-32V 173   | 49263            | 9-32V 35    | 73040            | 12-24V 206      | 78052            | 12-24V 192  | 79093            | 12-24V 193  |
| 63W41            | 12-32V 173  | 49282            | 9-32V 35    | 73040-5          | 12-24V 206      | 78053            | 12-24V 192  | 79100            | 12-24V 201  |
| 63W61            | 12-32V 173  | 49283            | 9-32V 35    | 73070            | 12-24V 207      | 78054            | 12-24V 192  | 79110            | 12-24V 201  |
| 63W71            | 12-32V 173  | 49351            | 24V 35      | 73080            | 12-24V 207      | 78055            | 12-24V 192  | 79120            | 12-24V 201  |
| 63Z61            | 14-32V 177  | 49352            | 24V 35      | 73090            | 12-24V 206      | 78061            | 12-24V 194  | 84611-5          | 12-36V 163  |
| 63Z71            | 14-32V 177  | 49353            | 24V 35      | 73110            | 12-24V 206      | 78063            | 12-24V 194  | 84621-5          | 12-36V 163  |
| 63Z81            | 14-32V 177  | 52072            | 24V 83      | 73160            | 12-24V 207      | 78065            | 12-24V 194  | 84631-5          | 12-30V 162  |
| 64E01            | 10-48V 178  | 52073            | 24V 83      | 73170            | 12-24V 207      | 78070            | 12-24V 193  | 84641-5          | 12-30V 162  |
| 64E01-5          | 10-48V 178  | 52092            | 24V 75      | 73220            | 12-24V 207      | 78071            | 12-24V 193  | 84651-4          | 12-36V 163  |
| 64E11            | 10-48V 178  | 52093            | 24V 75      | 73240            | 12-24V 206      | 78075            | 12-24V 193  | 84661-4          | 12-30V 162  |
| 64F11            | 10-48V 178  | 52152            | 24V 78      | 73250            | 12-24V 206      | 78080            | 12-24V 193  | 90941-5          | 9-32V 159   |
| 64F71            | 24V 178     | 52162            | 24V 76      | 73310            | 12-24V 207      | 78081            | 12-24V 193  | 90951-5          | 9-32V 160   |
| 64G01            | 10-48V 178  | 52163            | 24V 76      | 73350            | 12-24V 206      | 78085            | 12-24V 193  | 91051            | 24V 166     |
| 64G01-5          | 10/48V 178  | 56150            | 12/24V 98   | 73360            | 12-24V 206      | 78091            | 12-72V 195  | 94401-5          | 9-32V 161   |
| 64G11            | 10/48V 178  | 56160            | 12/24V 98   | 73370            | 12-24V 206      | 78092            | 12-72V 195  | 94411-5          | 9-32V 161   |
| 64G11-5          | 10/48V 178  | 56170            | 12/24V 98   | 76263            | 24V 192         | 78093            | 12-72V 195  | 94421-5          | 9-32V 161   |
| 64G61            | 24V 178     | 56180            | 12/24V 98   | 76683            | 12-24V 193      | 78094            | 12-72V 195  | BZ101-5          | 9-32V 183   |
| 64G71            | 24V 178     | 60711            | 9-32V 119   | 76685            | 12-24V 193      | 78095            | 12-72V 195  | BZ201-5          | 9-32V 183   |
| 64H51-4          | 12-36V 163  | 61111            | 24V 135     | 76693            | 12-24V 193      | 78113            | 12-72V 196  | BZ301-5          | 9-32V 183   |
| 64H51-5          | 12-36V 163  | 61861            | 9-30V 136   | 76792            | 11-30V 203      | 78122            | 12-24V 195  | BZ601-5          | 9-32V 183   |
| 64H61-4          | 12-36V 163  | 62321            | 24V 124     | 76793            | 11-30V 203      | 78123            | 12-24V 195  |                  |             |
| 64H61-5          | 12-36V 163  | 62571            | 24V 123     | 76795            | 11-30V 203      | 78125            | 12-24V 195  |                  |             |

Deutsch® is a registered trademark of TE Connectivity Corporation; Packard® is a registered trademark of DELPHI TECHNOLOGIES, INC.;

All product and company names are trademarks™ or registered® trademarks of their respective holders. Use of them does not imply any affiliation with or endorsement by them.







***PRODUCT / CUSTOMER NOTES:***

|       |       |
|-------|-------|
| <hr/> | <hr/> |
| <hr/> | <hr/> |
| <hr/> | <hr/> |
| <hr/> | <hr/> |
| <hr/> | <hr/> |
| <hr/> | <hr/> |
| <hr/> | <hr/> |
| <hr/> | <hr/> |
| <hr/> | <hr/> |
| <hr/> | <hr/> |
| <hr/> | <hr/> |
| <hr/> | <hr/> |
| <hr/> | <hr/> |
| <hr/> | <hr/> |
| <hr/> | <hr/> |
| <hr/> | <hr/> |
| <hr/> | <hr/> |
| <hr/> | <hr/> |
| <hr/> | <hr/> |
| <hr/> | <hr/> |
| <hr/> | <hr/> |
| <hr/> | <hr/> |
| <hr/> | <hr/> |
| <hr/> | <hr/> |
| <hr/> | <hr/> |
| <hr/> | <hr/> |
| <hr/> | <hr/> |
| <hr/> | <hr/> |
| <hr/> | <hr/> |
| <hr/> | <hr/> |









53252

## 4" ROUND PLATFORM

The 4" platform is used in a variety of trucks, trailers, agriculture, and construction equipment. The Grote® 4" line sets the standard and has a wide range of products to meet your needs: reliability, style, or value.



HARD SHELL



MALE PIN



PL3 (FEMALE PIN)

### 4" LED STOP/TAIL/TURN WITH INTEGRATED BACK-UP LAMPS

| Part Number | Description                 | Connector  | Voltage (nominal) | Current Draw                  | Flange Color    | Regulations / Standards   |
|-------------|-----------------------------|------------|-------------------|-------------------------------|-----------------|---------------------------|
| 55162       | Red, Grommet Mount          | Hard Shell | 12V               | S: .185A, T: .19A, B/U: .306A | NA              | FMVSS 108 / SAE I,S,T, R2 |
| 55202       | Red, Theft Resistant Flange | Hard Shell | 12V               | S: .185A, T: .19A, B/U: .306A | Stainless Steel | FMVSS 108 / SAE I,S,T, R2 |
| 55212       | Red, Theft Resistant Flange | Hard Shell | 12V               | S: .185A, T: .19A, B/U: .306A | Gray PC         | FMVSS 108 / SAE I,S,T, R2 |

### SUPERNOVA® 4" LED LAMPS

| Part Number | Description                            | Connector  | Voltage (nominal) | Current Draw        | Diode Layout | Regulations / Standards   |
|-------------|--|------------|-------------------|---------------------|--------------|---------------------------|
| 53252       | Red, Grommet Mount                     | Male Pin   | 12V               | S,I: .24A, T: .03A  | 10           | FMVSS 108 / SAE I,S,T, P2 |
| 53552       | Red, Grommet Mount                     | Hard Shell | 12V               | S,I: .24A, T: .03A  | 10           | FMVSS 108 / SAE I,S,T, P2 |
| 53532       | Red, Grommet Mount                     | Hard Wire  | 12V               | S,I: .24A, T: .03A  | 10           | FMVSS 108 / SAE I,S,T, P2 |
| 52092       | Red, Grommet Mount                     | Male Pin   | 24V               | S,I: .12A, T: .015A | 10           | FMVSS 108 / SAE I,S,T, P2 |
| 53272       | Red, Integrated Gray Flange            | Male Pin   | 12V               | S,I: .24A, T: .03A  | 10           | FMVSS 108 / SAE I,S,T, P2 |
| 53282       | Red, Integrated White Flange           | Male Pin   | 12V               | S,I: .24A, T: .03A  | 10           | FMVSS 108 / SAE I,S,T, P2 |
| 53292       | Red, Integrated Black Flange           | Male Pin   | 12V               | S,I: .24A, T: .03A  | 10           | FMVSS 108 / SAE I,S,T, P2 |
| 53302       | Red, Integrated Stainless Steel Flange | Male Pin   | 12V               | S,I: .24A, T: .03A  | 10           | FMVSS 108 / SAE I,S,T, P2 |
| 54622       | Red, Integrated Red Flange             | Male Pin   | 12V               | S,I: .24A, T: .03A  | 10           | FMVSS 108 / SAE I,S,T, P2 |
| 54032       | Red, Integrated Gray Flange            | Hard Shell | 12V               | S,I: .24A, T: .03A  | 10           | FMVSS 108 / SAE I,S,T, P2 |



**SUPERNOVA® 4" LED LAMPS (CONTINUED)**

| Part Number | Description                                  | Connector         | Voltage (nominal) | Current Draw                                      | Diode Layout | Regulations / Standards        |
|-------------|--|-------------------|-------------------|---|--------------|--------------------------------|
| 54042       | Red, Integrated Stainless Steel Flange       | Hard Shell        | 12V               | S,I: .24A, T: .03A                                | 10           | FMVSS 108 / SAE I,S,T, P2      |
| 53462       | Red, Kit (Grommet + Pigtail + Lamp)          | Male Pin          | 12V               | S,I: .24A, T: .03A                                | 10           | FMVSS 108 / SAE I,S,T, P2      |
| 53432       | Red, Kit (Stainless Flange + Pigtail + Lamp) | Male Pin          | 12V               | S,I: .24A, T: .03A                                | 10           | FMVSS 108 / SAE I,S,T, P2      |
| 65432-4     | Red, Heavy Duty Magnetic Towing Kit          | Round 4 Pole Plug | 12V               | S,I: .48A, T: .06A                                | 10           | FMVSS 108 / SAE I,S,T, P2      |
| 53253       | Yellow, Grommet Mount                        | Male Pin          | 12V               | P2: .15A  | 10           | FMVSS 108 / SAE P2             |
| 53553       | Yellow, Grommet Mount                        | Hard Shell        | 12V               | P2: .15A  | 10           | FMVSS 108 / SAE P3             |
| 52093       | Yellow, Grommet Mount                        | Male Pin          | 24V               | P2: .12A  | 10           | FMVSS 108 / SAE P2             |
| 53293       | Yellow, Integrated Black Flange              | Male Pin          | 12V               | P2: .15A  | 10           | FMVSS 108 / SAE P2             |
| 53303       | Yellow, Integrated Stainless Steel Flange    | Male Pin          | 12V               | P2: .15A  | 10           | FMVSS 108 / SAE P2             |
| 63561       | White, Integrated Rubber Housing, Utility    | Hardwire          | 12V               | .6A   | 10           | NA                             |
| 54302       | Red, Grommet Mount                           | Male Pin          | 12V/24V           | 13.5V S,I: .09A, T: .01A / 28V S,I: .05A, T: .01A | 3            | FMVSS 108 / SAE I,S,T, P2      |
| 54332       | Red, Grommet Mount                           | Male Pin          | 12V               | S,I: .15A, T: .01A                                | 3            | FMVSS 108 / SAE I,S,T, P2      |
| 54472       | Red, Integrated Gray Flange                  | Male Pin          | 12V               | S,I: .15A, T: .01A                                | 3            | FMVSS 108 / SAE I,S,T, P2      |
| 54482       | Red, Integrated Black Flange                 | Male Pin          | 12V               | S,I: .15A, T: .01A                                | 3            | FMVSS 108 / SAE I,S,T, P2      |
| 54492       | Red, Integrated Stainless Steel Flange       | Male Pin          | 12V               | S,I: .15A, T: .01A                                | 3            | FMVSS 108 / SAE I,S,T, P2      |
| 54602       | Red, Integrated Flange with Gasket           | Male Pin          | 12V               | S,I: .15A, T: .01A                                | 3            | FMVSS 108 / SAE I,S,T, P2      |
| 54292       | Red, Grommet Mount                           | Hard Shell        | 12V/24V           | 13.5V S,I: .09A, T: .01A / 28V S,I: .05A, T: .01A | 3            | FMVSS 108 / SAE I,S,T, P2      |
| 54362       | Red, Grommet Mount                           | Hard Shell        | 12V               | S,I: .15A, T: .01A                                | 3            | FMVSS 108 / SAE I,S,T, P2      |
| 54573       | Red, Integrated Flange                       | Hard Shell        | 12V/24V           | 13.5V S,I: .09A, T: .01A / 28V S,I: .05A, T: .01A | 3            | FMVSS 108 / SAE I,S,T, P2      |
| 51002       | Red, Power Module, RH                        | UBS .180          | 12V               | S,I: .24A, P2:.06A, T: .03A                       | 3            | FMVSS 108 / SAE A, I, P2, S, T |
| 51012       | Red Power Module, LH                         | UBS .180          | 12V               | S,I: .24A, P2: .06A, T: .03A                      | 3            | FMVSS 108 / SAE A, I, P2, S, T |
| 54313       | Yellow, Grommet Mount                        | Hard Shell        | 12V               | I6: .35A, P3,P: .043                              | 3            | FMVSS 108 / SAE I6, P, P3      |



### SUPERNOVA® 4" LED LAMPS (CONTINUED)

| Part Number | Description   | Connector  | Voltage (nominal) | Current Draw            | Diode Layout | Regulations / Standards     |
|-------------|---|------------|-------------------|-------------------------|--------------|-----------------------------|
| 54333       | Yellow, Grommet Mount                                   | Male Pin   | 12V               | I: .15A                 | 3            | FMVSS 108 / SAE P2          |
| 54493       | Yellow, Integrated Stainless Steel Flange               | Male Pin   | 12V               | I: .15A                 | 3            | FMVSS 108 / SAE P2          |
| 54363       | Yellow, Grommet Mount                                   | Hard Shell | 12V               | I: .15A                 | 3            | FMVSS 108 / SAE P2          |
| 54643       | Yellow, Grommet Mount, 2 Pin                            | Male Pin   | 12V               | I, T: .16A              | 3            | FMVSS 108 / SAE T           |
| 62091       | White, Dual System Back-Up                              | Male Pin   | 12V               | .55A                    | 3            | FMVSS 108 / SAE (2) R       |
| 62101       | White, Dual System Back-Up                              | Hard Shell | 12V               | .55A                    | 3            | FMVSS 108 / SAE (2) R       |
| 62791       | White, Dual System Back-Up, Integrated Flange w/ Gasket | Male Pin   | 12V               | .55A                    | 3            | FMVSS 108 / SAE (2) R       |
| 60631       | White, Integrated Clear Flange w/Gasket Hook-up         | Male Pin   | 12V               | .5A                     | 3            | NA                          |
| 53312       | Red, Grommet Mount                                      | Male Pin   | 12V               | S, I: .48A, P2, T: .04A | 24           | FMVSS 108 / SAE I, P2, S, T |
| 52162       | Red, Grommet Mount                                      | Male Pin   | 24V               | S, I: .2A P2, T: .02A   | 24           | FMVSS 108 / SAE I, P2, S, T |
| 54562       | Red, Grommet Mount                                      | Hard Shell | 12V               | S, I: .48A, P2, T: .04A | 24           | FMVSS 108 / SAE I, P2, S, T |
| 53182       | Red, Integrated Black Flange                            | Male Pin   | 12V               | S, I: .48A, P2, T: .04A | 24           | FMVSS 108 / SAE I, P2, S, T |
| 53192       | Red, Integrated Stainless Steel Flange                  | Male Pin   | 12V               | S, I: .48A, P2, T: .04A | 24           | FMVSS 108 / SAE I, P2, S, T |
| 53413       | Yellow, Grommet Mount                                   | Male Pin   | 12V               | I: .71A P2: .14A        | 24           | FMVSS 108 / SAE I, P2       |
| 52163       | Yellow, Grommet Mount                                   | Male Pin   | 24V               | I: .34A, P2: .06A       | 24           | FMVSS 108 / SAE I, P2       |
| 53313       | Yellow, Grommet Mount                                   | Male Pin   | 12V               | I: 1.06A, P,P2: .13A    | 24           | FMVSS 108 / SAE I, P, P2    |
| 55103       | Yellow, Grommet Mount, 2 Pin                            | Male Pin   | 12V               | I: .71A, P2; .14A       | 24           | FMVSS 108 / SAE I, P2       |
| 62401       | White, Single System Back-Up                            | Male Pin   | 12V               | .6A                     | 24           | FMVSS 108 / SAE R           |
| 62391       | White, Dual System Back-Up                              | Male Pin   | 12V               | .25A                    | 24           | FMVSS 108 / SAE (2) R       |
| 62571       | White, Dual System Back-Up                              | Male Pin   | 24V               | .15A                    | 24           | FMVSS 108 / SAE (2) R       |
| 77351       | White, Grommet Mount, Strobe                            | Male Pin   | 12V               | .25A                    | 24           | NA                          |
| 77352       | Red, Grommet Mount, Strobe                              | Male Pin   | 12V               | .25A                    | 24           | SAE Class II                |
| 77353       | Yellow, Grommet Mount, Strobe                           | Male Pin   | 12V               | .25A                    | 24           | SAE Class II                |
| 77355       | Blue, Grommet Mount, Strobe                             | Male Pin   | 12V               | .25A                    | 24           | SAE Class III               |
| 77193       | Yellow, Integrated Rubber Housing, Strobe               | UBS .180   | 12V               | .25A                    | 24           | SAE Class II                |



### HI COUNT® 4" LED LAMPS

| Part Number | Description                                       | Connector | Voltage (nominal) | Current Draw            | Diode Layout | Regulations / Standards     |
|-------------|---|-----------|-------------------|-------------------------|--------------|-----------------------------|
| G4002       | Red, Grommet Mount                                | PL3       | 12V               | S, I: .48A, P2, T: .04A | 24           | FMVSS 108 / SAE I, P2, S, T |
| G4002-5     | Red, Grommet Mount, Retail Pack                   | PL3       | 12V               | S, I: .48A, P2, T: .04A | 24           | FMVSS 108 / SAE I, P2, S, T |
| G4022       | Red, Clear Lens, Grommet Mount                    | PL3       | 12V               | S, I: .48A, P2, T: .04A | 24           | FMVSS 108 / SAE I, P2, S, T |
| G4023       | Yellow, Clear Lens, Grommet Mount                 | PL3       | 12V               | I: .71A                 | 39           | FMVSS 108 / SAE I           |
| G4012       | Red, Grommet Mount Kit (Pigtail + Grommet + Lamp) | PL3       | 12V               | S, I: .48A, P2, T: .04A | 24           | FMVSS 108 / SAE I, P2, S, T |
| G4003       | Yellow, Grommet Mount                             | PL3       | 12V               | I: .71A                 | 39           | FMVSS 108 / SAE I           |

### GROTE SELECT® 4" LED LAMPS

| Part Number | Description                    | Connector | Voltage (nominal) | Current Draw  | Diode Layout | Regulations / Standards     |
|-------------|--------------------------------|-----------|-------------------|---|--------------|-----------------------------|
| 54342       | Red, Grommet Mount             | PL3       | 12V               | S, I: .24A, P2, T: .03A                             | 3            | FMVSS 108 / SAE I, P2, S, T |
| 54282       | Red, Grommet Mount, Multi-Volt | PL3       | 12V/24V           | 9V S, I: .92A, T: .089A / 32V S, I: .478A, T: .103A | 3            | FMVSS 108 / SAE I, P2, S, T |
| 54343       | Yellow, Grommet Mount          | PL3       | 12V               | P2: .03A  | 3            | FMVSS 108 / SAE P2          |
| 62691       | White, Dual System Back-up     | PL3       | 12V               | .55A  | 3            | FMVSS 108 / SAE (2)R        |





62121



52672



53103



50820



62271



53102

## INCANDESCENT 4" LAMPS

| Part Number | Description   | Connector | Voltage (nominal) | Current Draw            | Branding          | Regulations / Standards       |
|-------------|---|-----------|-------------------|-------------------------|-------------------|-------------------------------|
| 53102       | Red, Grommet Mount  | Male Pin  | 12V               | S, I: 2.1A, P2, T: .48A | Torsion Mount® II | FMVSS 108 / SAE S, I, P2, T   |
| 53112       | Red, Grommet Mount Kit (Pigtail, Grommet, Lamp)                         | Male Pin  | 12V               | S, I: 2.1A, P2, T: .48A | Torsion Mount® II | FMVSS 108 / SAE S, I, P2, T   |
| 52770       | Red, Clear Housing, Grommet Mount                                       | PL3       | 12V               | S, I: 2.1A, P2, T: .48A | Torsion Mount® II | FMVSS 108 / SAE S, I, T       |
| 52772       | Red, Grommet Mount  | PL3       | 12V               | S, I: 2.1A, P2, T: .48A | Torsion Mount® II | FMVSS 108 / SAE S, I, P2, T   |
| 52152       | Red, Grommet Mount  | PL3       | 24V               | S, I: 2.1A, P2, T: .48A | Torsion Mount® II | FMVSS 108 / SAE S, I, P2, T   |
| 52782       | Red, Grommet Mount Kit (Pigtail + Grommet + Lamp)                       | PL3       | 12V               | S, I: 2.1A, P2, T: .48A | Torsion Mount® II | FMVSS 108 / SAE S, I, P2, T   |
| 53103       | Yellow, Grommet Mount   | Male Pin  | 12V               | I: 2.1A, P: .48A        | Torsion Mount® II | FMVSS 108 / SAE I, P          |
| 52773       | Yellow, Grommet Mount   | PL3       | 12V               | I: 2.1A, P: .48A        | Torsion Mount® II | FMVSS 108 / SAE I, P          |
| 52672       | Red, Grommet Mount with Built-In Reflector                              | PL3       | 12V               | S, I: 2.1A, P2, T: .48A | Torsion Mount II  | FMVSS 108 / SAE S, I, P2, T   |
| 52682       | Red, Grommet Mount with Built-In Reflector Kit (Pigtail, Grommet, Lamp) | PL3       | 12V               | S, I: 2.1A, P2, T: .48A | Torsion Mount® II | FMVSS 108 / SAE S, I, P2, T   |
| 50820       | Red, Power Module (Back-up + License Lamp + 2 STT)                      | PL3       | 12V               | Multiple Functions      | Torsion Mount® II | FMVSS 108 / SAE A, I, L, R, T |
| 62211       | White, Single System Back-up  | Male Pin  | 12V               | 2.1A                    | Torsion Mount II  | FMVSS 108 / SAE R             |
| 62271       | White, Single System Back-up  | PL3       | 12V               | 2.1A                    | Torsion Mount® II | FMVSS 108 / SAE R             |
| 62331       | White, Single System Back-up Kit (Pigtail + Grommet + Lamp)             | PL3       | 12V               | 2.1A                    | Torsion Mount® II | FMVSS 108 / SAE R             |
| 62121       | White/Frosted, Dual System Back-up                                      | Male Pin  | 12V               | 2.1A                    | Torsion Mount® II | FMVSS 108 / SAE (2)R          |
| 62171       | White/Frosted, Dual System Back-up                                      | PL3       | 12V               | 2.1A                    | Torsion Mount® II | FMVSS 108 / SAE (2)R          |
| 62321       | White/Frosted, Dual System Back-up                                      | PL3       | 24V               | 2.1A                    | Torsion Mount® II | FMVSS 108 / SAE (2)R          |





**INCANDESCENT 4" LAMPS (CONTINUED)**

| Part Number | Description  | Connector         | Voltage (nominal) | Current Draw                  | Branding          | Regulations / Standards         |
|-------------|--|-------------------|-------------------|-------------------------------|-------------------|---------------------------------|
| 62181       | White/Frosted, Dual System Back-up Kit (Pigtail, Grommet, Lamp)          | PL3               | 12V               | 2.1A                          | Torsion Mount® II | FMVSS 108 / SAE (2)R            |
| 61451       | Clear, Grommet Mount Dome Lamp   | Male Pin          | 12V               | 1.04A                         | Torsion Mount® II | NA                              |
| 61051       | Clear, Grommet Mount Dome Lamp   | PL3               | 12V               | 1.04A                         | Torsion Mount® II | NA                              |
| 52922       | Red, Grommet Mount   | PL3               | 12V               | S, I: 2.1A, P2, T: .48A       | Economy           | FMVSS 108 / SAE S, I, P2, T     |
| 52922-5     | Red, Grommet Mount, Retail Pack  | PL3               | 12V               | S, I: 2.1A, P2, T: .48A       | Economy           | FMVSS 108 / SAE S, I, P2, T     |
| 53012       | Red, Grommet Mount Kit (Pigtail + Grommet + Lamp)                        | PL3               | 12V               | S, I: 2.1A, P2, T: .48A       | Economy           | FMVSS 108 / SAE S, I, P2, T     |
| 53012-5     | Red, Grommet Mount Kit (Pigtail + Grommet + Lamp), Retail Pack           | PL3               | 12V               | S, I: 2.1A, P2, T: .48A       | Economy           | FMVSS 108 / SAE S, I, P2, T     |
| 52923       | Yellow, Grommet Mount, Front, Park & Turn                                | PL3               | 12V               | I: 2.1A, P: .48A              | Economy           | FMVSS 108 / SAE I, P2           |
| 51052       | Red, Power Module  | UBS .180          | 12V               | S, I: 2.1A, P2, T: .48A       | Economy           | FMVS: 108 A, S, I, P2, T        |
| 51022       | Red, Power Module, RH  | UBS .180          | 12V               | S, I: 2.1A, T: .48A, P2: .54A | Economy           | FMVSS 108 / SAE A, S, I, P2, T  |
| 51032       | Red, Power Module, LH  | UBS .180          | 12V               | S, I: 2.1A, T: .48A, P2: .54A | Economy           | FMVSS 108 / SAE A, S, I, P2, T  |
| 50222       | Red, Double Contact, Integrated Black Housing                            | Hardwire          | 12V               | S, I: 2.1A, P2, P3, T: .59A   | Economy           | FMVSS 108 / SAE S, I, P2, P3, T |
| 50502       | Red, Double Contact, Integrated Rubber Housing                           | Hardwire          | 12V               | S, I: 2.1A, P2, P3, T: .59A   | Economy           | FMVSS 108 / SAE S, I, P2, P3, T |
| 52522       | Red, Double Contact, Integrated Stainless Steel Housing                  | Hardwire          | 12V               | S, I: 2.1A, P2, P3, T: .59A   | Economy           | FMVSS 108 / SAE S, I, P2, P3, T |
| 50232       | Red, Double Contact, Integrated Black Painted Steel Housing              | Hardwire          | 12V               | S, I: 2.1A, P2, P3, T: .59A   | Economy           | FMVSS 108 / SAE S, I, P2, P3, T |
| 50232-5     | Red, Double Contact, Integrated Black Painted Steel Housing, Retail Pack | Hardwire          | 12V               | S, I: 2.1A, P2, P3, T: .59A   | Economy           | FMVSS 108 / SAE S, I, P2, P3, T |
| 65402-4     | Red, Magnetic Towing Kit   | Round 4 Pole Plug | 12V               | S, I: 4.2A, P2, T: .96A       | Economy           | FMVSS 108 / SAE S, I, P2, T     |



53962

## 6" OVAL PRODUCT PLATFORM

The oval stop/tail/turn has a variety of uses and can be found on all manners of heavy-duty trucks, trailers and pull-behind toy trailers. Guaranteed performance with a wide variety of connection and mounting options to boot. The oval shape does double duty as not only a stop tail and turn but also a back-up lamp, dome lamp or in the case of the 4-in-1 a mashup of many lamps in one – stop, tail, turn and back-up.



HARD SHELL



MALE PIN



PL3 (FEMALE PIN)

### 6" LED STOP/TAIL/TURN WITH INTEGRATED BACK-UP LAMPS

| Part Number | Description                    | Connector  | Voltage (nominal) | Current Draw                    | Material                              | Regulations / Standards       |
|-------------|--------------------------------|------------|-------------------|---------------------------------|---------------------------------------|-------------------------------|
| 54672       | Red, Grommet Mount             | Male Pin   | 12V               | S, L: .13A, T: .17A, (2)R: .16A | Red - High Impact Acrylic; Clear - PC | FMVSS 108 / SAE I, S, T, (2)R |
| 54682       | Red, Grommet Mount             | PL3        | 12V               | S, L: .13A, T: .17A, (2)R: .16A | Red - High Impact Acrylic; Clear - PC | FMVSS 108 / SAE I, S, T, (2)R |
| 54702       | Red, Grommet Mount             | Hard Shell | 12V               | S, L: .13A, T: .17A, (2)R: .16A | Red - High Impact Acrylic; Clear - PC | FMVSS 108 / SAE I, S, T, (2)R |
| 54722       | Red, Grommet Mount, No Back-up | Hard Shell | 12V               | S, L: .13A, T: .17A             | Red - High Impact Acrylic             | FMVSS 108 / SAE I, S, T       |
| 54752       | Red, Grommet Mount, No Back-up | Male Pin   | 12V               | S, L: .13A, T: .17A             | Red - High Impact Acrylic             | FMVSS 108 / SAE I, S, T       |
| 54762       | Red, Grommet Mount, No Back-up | PL3        | 12V               | S, L: .13A, T: .17A             | Red - High Impact Acrylic             | FMVSS 108 / SAE I, S, T       |

### SUPERNOVA® 6" OVAL LED LAMPS

| Part Number | Description                            | Connector | Voltage (nominal) | Current Draw        | Diode Layout | Regulations / Standards     |
|-------------|--|-----------|-------------------|---------------------|--------------|-----------------------------|
| 53962       | Red, Grommet Mount                     | Male Pin  | 12V               | S, L: .48A, T: .06A | 16           | FMVSS 108 / SAE I, S, T, P2 |
| 52072       | Red, Grommet Mount                     | Male Pin  | 24V               | S, L: .24A, T: .03A | 16           | FMVSS 108 / SAE I, S, T, P2 |
| 53592       | Red, Integrated Gray Flange            | Male Pin  | 12V               | S, L: .48A, T: .06A | 16           | FMVSS 108 / SAE I, S, T, P2 |
| 53622       | Red, Integrated Black Flange           | Male Pin  | 12V               | S, L: .48A, T: .06A | 16           | FMVSS 108 / SAE I, S, T, P2 |
| 53972       | Red, Integrated Stainless Steel Flange | Male Pin  | 12V               | S, L: .48A, T: .06A | 16           | FMVSS 108 / SAE I, S, T, P2 |
| 54802       | Red, Clear Lens, Grommet Mount         | Hard Wire | 12V               | S, L: .48A, T: .06A | 16           | FMVSS 108 / SAE I, S, T, P2 |



54672 / 54682 / 54702



53973



54132 / 54142



54213



62561 / 62591 / 62601



54722 / 54752 / 54762

**SUPERNOVA® 6" OVAL LED LAMPS (CONTINUED)**

| Part Number | Description   | Connector  | Voltage (nominal) | Current Draw          | Diode Layout | Regulations / Standards     |
|-------------|---|------------|-------------------|-----------------------|--------------|-----------------------------|
| 53122       | Red, Grommet Mount Kit (Pigtail + Grommet + Lamp)                   | Male Pin   | 12V               | S, I: .48A, T: .06A   | 16           | FMVSS 108 / SAE I, S, T, P2 |
| 53963       | Yellow, Grommet Mount   | Male Pin   | 12V               | P2: .48A              | 16           | FMVSS 108 / SAE P2          |
| 52073       | Yellow, Grommet Mount   | Male Pin   | 24V               | P2: .24A              | 16           | FMVSS 108 / SAE P2          |
| 53593       | Yellow, Integrated Gray Flange                                      | Male Pin   | 12V               | P2: .48A              | 16           | FMVSS 108 / SAE P2          |
| 53973       | Yellow, Integrated Stainless Steel Flange                           | Male Pin   | 12V               | P2: .48A              | 16           | FMVSS 108 / SAE P2          |
| 53123       | Yellow, Grommet Mount Kit (Pigtail + Grommet + Lamp)                | Male Pin   | 12V               | P2: .48A              | 16           | FMVSS 108 / SAE P2          |
| 54132       | Red, Grommet Mount  | Male Pin   | 12V               | S, I: .14A, T: .02A   | 9            | FMVSS 108 / SAE I, S, T, P2 |
| 54142       | Red, Grommet Mount  | Hard Shell | 12V               | S, I: .14A, T: .02A   | 9            | FMVSS 108 / SAE I, S, T, P2 |
| 65390-4     | Red, Light Duty Trailer Kit (Pigtail + Bracket + Grommet + Lamp x2) | Male Pin   | 12V               | S, I: .48A, T: .06A   |              | FMVSS 108 / SAE S, I, T     |
| 54133       | Yellow, Grommet Mount   | Male Pin   | 12V               | S, I: .14A, T: .02A   | 9            | FMVSS 108 / SAE P2          |
| 54143       | Yellow, Grommet Mount   | Hard Shell | 12V               | S, I: .14A, T: .02A   | 9            | FMVSS 108 / SAE P2          |
| 54183       | Yellow, Grommet Mount   | Male Pin   | 12V               | E, E2: .45A, P2: .06A | 1            | FMVSS 108 / SAE E, E2, P2   |
| 54193       | Yellow, Grommet Mount   | Hard Shell | 12V               | E, E2: .45A, P2: .06A | 1            | FMVSS 108 / SAE E, E2, P2   |
| 54253       | Yellow, Integrated Black Theft Resistant Flange                     | Male Pin   | 12V               | E, E2: .45A, P2: .06A | 1            | FMVSS 108 / SAE E, E2, P2   |
| 54263       | Yellow, Integrated Stainless Steel Theft Resistant Flange           | Male Pin   | 12V               | E, E2: .45A, P2: .06A | 1            | FMVSS 108 / SAE E, E2, P2   |
| 54243       | Yellow, Integrated Gray Theft Resistant Flange                      | Male Pin   | 12V               | E, E2: .45A, P2: .06A | 1            | FMVSS 108 / SAE E, E2, P2   |
| 54203       | Yellow, Integrated Yellow Housing Flange                            | Male Pin   | 12V               | E, E2: .45A, P2: .06A | 1            | FMVSS 108 / SAE E, E2, P2   |
| 54213       | Yellow, Integrated Yellow Housing Flange                            | Hard Shell | 12V               | E, E2: .45A, P2: .06A | 1            | FMVSS 108 / SAE E, E2, P2   |
| 62561       | Clear, Grommet Mount, Single Back Up                                | Male Pin   | 12V               | R: .30A               | 24           | FMVSS 108 / SAE R           |
| 62601       | Clear, Grommet Mount, Dual Back Up, Horizontal Mount                | Male Pin   | 12V               | (2) R: .30A           | 24           | FMVSS 108 / SAE (2) R       |
| 62591       | Clear, Grommet Mount, Dual Back Up, Vertical Mount                  | Male Pin   | 12V               | (2) R: .30A           | 24           | FMVSS 108 / SAE (2) R       |



## HI COUNT® LAMPS

| Part Number | Description                       | Connector | Voltage (nominal) | Current Draw             | Diode Layout | Regulations / Standards     |
|-------------|-----------------------------------|-----------|-------------------|--------------------------|--------------|-----------------------------|
| G6002       | Red, Grommet Mount                | PL3       | 12V               | S, I: .33A, P2, T: .015A | 56           | FMVSS 108 / SAE I, P2, S, T |
| G6002-5     | Red, Grommet Mount, Retail Pack   | PL3       | 12V               | S, I: .33A, P2, T: .015A | 56           | FMVSS 108 / SAE I, P2, S, T |
| G6012       | Red, Clear Lens, Grommet Mount    | PL3       | 12V               | S, I: .33A, P2, T: .015A | 56           | FMVSS 108 / SAE I, P2, S, T |
| G6003       | Yellow, Grommet Mount             | PL3       | 12V               | P: .03A, T: .36A         | 56           | FMVSS 108 / SAE P, T        |
| G6013       | Yellow, Clear Lens, Grommet Mount | PL3       | 12V               | P: .03A, T: .36A         | 56           | FMVSS 108 / SAE P, T        |

## NEXGEN LAMPS

| Part Number | Description                        | Connector | Voltage (nominal) | Current Draw            | Diode Layout | Regulations / Standards      |
|-------------|------------------------------------|-----------|-------------------|-------------------------|--------------|------------------------------|
| 54162       | Red, Grommet Mount                 | Male Pin  | 12V               | S, I: .14A, P2, T: .02A | 3            | FMVSS 108 / SAE I6, P2, S, T |
| 54163       | Yellow, Grommet Mount              | Male Pin  | 12V               |                         | 3            | FMVSS 108 / SAE P, P2        |
| 62051       | Clear, Grommet Mount, Dual Back-up | Male Pin  | 12V               | (2) R .30A              | 3            | FMVSS 108 / SAE (2) R        |

## GROTE SELECT® LED LAMPS

| Part Number | Description                        | Connector | Voltage (nominal) | Current Draw            | Diode Layout | Regulations / Standards      |
|-------------|------------------------------------|-----------|-------------------|-------------------------|--------------|------------------------------|
| 54172       | Red, Grommet Mount                 | PL3       | 12V               | S, I: .48A, P2, T: .04A | 3            | FMVSS 108 / SAE I6, P2, S, T |
| 54173       | Yellow, Grommet Mount              | PL3       | 12V               | I: .71A                 | 3            | FMVSS 108 / SAE I            |
| 62751       | Clear, Grommet Mount, Dual Back-up | PL3       | 12V               | (2) R .30A              | 3            | FMVSS 108 / SAE (2) R        |

## MISCELLANEOUS 6" OVAL LED LAMPS

| Part Number | Description                          | Connector | Voltage (nominal) | Current Draw            | Diode Layout | Regulatory / Standards    |
|-------------|--------------------------------------|-----------|-------------------|-------------------------|--------------|---------------------------|
| 52592-5     | Red, Chrome Trim Ring, Surface Mount | Hard Wire | 12V               | S, I: .22A, P2, T: .04A | 10           | FMVSS 108 / SAE I, S, T   |
| 52423       | Yellow, LED Hybrid, Surface Mount    | Packard®  | 12V               | P2: .06A, E, E2: 2.1A   | Hybrid       | FMVSS 108 / SAE E, E2, P2 |
| 61G31       | Clear, Grommet Mount Dome            | Male Pin  | 12V               | .6A                     | 4            | NA                        |





62521



52182



52562



52533



62521

## INCANDESCENT 6" LAMPS

| Part Number | Description  | Connector | Voltage (nominal) | Current Draw            | Branding          | Regulations / Standards     |
|-------------|--|-----------|-------------------|-------------------------|-------------------|-----------------------------|
| 52562       | Red, Grommet Mount   | Male Pin  | 12V               | S, I: 2.1A, P2, T: .59A | Torsion Mount® II | FMVSS 108 / SAE S, I, P2, T |
| 52892       | Red, Grommet Mount   | PL3       | 12V               | S, I: 2.1A, P2, T: .59A | Torsion Mount® II | FMVSS 108 / SAE S, I, P2, T |
| 52572       | Red, Grommet Mount Kit (Pigtail + Grommet + Lamp)          | PL3       | 12V               | S, I: 2.1A, P2, T: .59A | Torsion Mount® II | FMVSS 108 / SAE S, I, P2, T |
| 52563       | Yellow, Grommet Mount                                      | Male Pin  | 12V               | I: 2.1A, P: .48A        | Torsion Mount® II | FMVSS 108 / SAE I, P        |
| 52893       | Yellow, Grommet Mount Kit (Pigtail + Grommet + Lamp)       | Male Pin  | 24V               | I: 2.1A, P: .48A        | Torsion Mount® II | FMVSS 108 / SAE I, P        |
| 52533       | Yellow, Grommet Mount                                      | Male Pin  | 12V               | E: 2.1A, P2, P3: .59A   | Torsion Mount® II | FMVSS 108 / SAE E, P2, P3   |
| 52513       | Yellow, Grommet Mount                                      | PL3       | 12V               | E: 2.1A, P2, P3: .59A   | Torsion Mount® II | FMVSS 108 / SAE E, P2, P3   |
| 62231       | Clear, Grommet Mount Dual Back-up                          | PL3       | 12V               | (2)R: 2.1A              | Torsion Mount® II | FMVSS 108 / SAE (2) R       |
| 62251       | Clear, Grommet Mount Kit (Pigtail + Grommet + Lamp)        | PL3       | 12V               | (2)R: 2.1A              | Torsion Mount® II | FMVSS 108 / SAE (2) R       |
| 52182       | Red, Grommet Mount   | PL3       | 12V               | S, I: 2.1A, P2, T: .59A | Economy           | FMVSS 108 / SAE S, I, P2, T |
| 52182-5     | Red, Grommet Mount Retail Pack                             | PL3       | 12V               | S, I: 2.1A, P2, T: .59A | Economy           | FMVSS 108 / SAE S, I, P2, T |
| 53092       | Red, Grommet Mount Kit (Pigtail + Grommet + Lamp)          | PL3       | 12V               | S, I: 2.1A, P2, T: .59A | Economy           | FMVSS 108 / SAE S, I, P2, T |
| 53082-5     | Red, Light Duty Trailer Kit (Pigtail + Bracket + Lamp x 2) | PL3       | 12V               | S, I: 2.1A, P2, T: .59A | Economy           | FMVSS 108 / SAE S, I, T     |
| 52183       | Yellow, Grommet Mount                                      | PL3       | 12V               | I: 2.1A, P: .59A        | Economy           | FMVSS 108 / SAE I, P        |
| 53093       | Yellow, Grommet Mount Kit (Pigtail + Grommet + Lamp)       | PL3       | 12V               | I: 2.1A, P: .59A        | Economy           | FMVSS 108 / SAE I, P        |
| 52193       | Yellow, Grommet Mount                                      | PL3       | 12V               | E: 2.1A, P2: .48A       | Economy           | FMVSS 108 / SAE E, P2       |
| 52253       | Yellow, Grommet Mount Kit (Pigtail + Grommet + Lamp)       | PL3       | 12V               | E: 2.1A, P2: .48A       | Economy           | FMVSS 108 / SAE E, P3       |
| 62521       | Clear, Grommet Mount Dual Back-up                          | PL3       | 12V               | (2) R: 2.1A             | Economy           | FMVSS 108 / SAE (2) R       |





49393

## TURTLEBACK® PLATFORM



MALE PIN

The Turtleback® lamp gets its name from the convex design of the lens which deflects limbs and other impacts. Now available in both incandescent and LED options, there is a TBII version for almost any trailer use, including dual-function auxiliary high-mount stop lights.



47162



54002



47073

### SUPERNOVA® TURTLEBACK® LED LAMPS

| Part Number | Description                        | Connector | Voltage (nominal) | Current Draw       | Material                 | Regulations / Standards |
|-------------|------------------------------------|-----------|-------------------|--------------------|--------------------------|-------------------------|
| 47072       | Red, Reflex Lens                   | Male Pin  | 12V               | P2: .06A           | Acrylic Lens, PC Housing | FMVSS 108 / SAE A, P2   |
| 47073       | Yellow, Reflex Lens                | Male Pin  | 12V               | P2: .06A           | Acrylic Lens, PC Housing | FMVSS 108 / SAE A, P2   |
| 47162       | Red, Optic Lens                    | Male Pin  | 12V               | P2, PC: .06A       | PC Lens & Housing        | FMVSS 108 / SAE P2, PC  |
| 49392       | Red, Optic Lens                    | Hard Wire | 12V               | P2, PC: .06A       | PC Lens & Housing        | FMVSS 108 / SAE P2, PC  |
| 47163       | Yellow, Optic Lens                 | Male Pin  | 12V               | P2, PC: .06A       | PC Lens & Housing        | FMVSS 108 / SAE P2, PC  |
| 49393       | Yellow, Optic Lens                 | Hard Wire | 12V               | P2, PC: .06A       | PC Lens & Housing        | FMVSS 108 / SAE P2, PC  |
| 78403       | Yellow, ABS                        | Male Pin  | 12V               | P2: .06A           | PC Lens & Housing        | FMVSS 108 / SAE P2      |
| 54002       | Red, Optic Lens, Dual Intensity    | Male Pin  | 12V               | U: .25A, P2: .025A | PC Lens & Housing        | FMVSS 108 / SAE U, P2   |
| 54003       | Yellow, Optic Lens, Dual Intensity | Male Pin  | 12V               | U: .25A, P2: .025A | PC Lens & Housing        | FMVSS 108 / SAE U, P3   |



### HI COUNT® LED LAMPS

| Part Number | Description         | Connector | Voltage (nominal) | Current Draw | Diode Layout | Regulations / Standards |
|-------------|---------------------|-----------|-------------------|--------------|--------------|-------------------------|
| G2102       | Red, Reflex Lens    | Hard Wire | 12V               | P2: .12A     | 8            | FMVSS 108 / SAE A, P2   |
| G2103       | Yellow, Reflex Lens | Hard Wire | 12V               | P2: .15A     | 10           | FMVSS 108 / SAE A, P2   |

### INCANDESCENT LAMPS

| Part Number | Description                                      | Connector | Voltage (nominal) | Current Draw        | Branding       | Regulations / Standards |
|-------------|--|-----------|-------------------|---------------------|----------------|-------------------------|
| 46832       | Red, Optic Lens                                  | Male Pin  | 12V               | P2: .66A            | TurtleBack® II | FMVSS 108 / SAE P2, P3  |
| 46833       | Yellow, Optic Lens                               | Male Pin  | 12V               | P2: .66A            | TurtleBack® II | FMVSS 108 / SAE P2, P3  |
| 46872       | Red, Reflex Lens                                 | Male Pin  | 12V               | P2: .66A            | TurtleBack® II | FMVSS 108 / SAE A, P2   |
| 46873       | Yellow, Reflex Lens                              | Male Pin  | 12V               | P2: .66A            | TurtleBack® II | FMVSS 108 / SAE A, P2   |
| 78363       | Yellow, Optic Lens, ABS                          | Male Pin  | 12V               | P2: .66A            | TurtleBack® II | FMVSS 108 / SAE P2, P3  |
| 60331       | Clear Lens, License                              | Male Pin  | 12V               | L: .66A             | TurtleBack® II | FMVSS 108 / SAE L       |
| 46072       | Red, Reflex Lens                                 | Hard Wire | 12V               | P2: .33A            | Economy        | FMVSS 108 / SAE A, P2   |
| 46082       | Red, Reflex Lens, Kit (Pigtail and Lamp)         | Hard Wire | 12V               | P2: .33A            | Economy        | FMVSS 108 / SAE A, P2   |
| 46073       | Yellow, Reflex Lens                              | Hard Wire | 12V               | P2: .33A            | Economy        | FMVSS 108 / SAE A, P2   |
| 46083       | Yellow, Reflex Lens Kit (Pigtail and Lamp)       | Hard Wire | 12V               | P2: .33A            | Economy        | FMVSS 108 / SAE A, P2   |
| 45462       | Red, Optic Lens, Two Bulb                        | UBS .180  | 12V               | P2: .66A            | TurtleBack®    | FMVSS 108 / SAE P2      |
| 45463       | Yellow, Optic Lens, Two Bulb                     | UBS .180  | 12V               | P2: .66A            | TurtleBack®    | FMVSS 108 / SAE P2      |
| 46302       | Red, Reflex Lens, Two Bulb                       | UBS .180  | 12V               | P2: .66A            | TurtleBack®    | FMVSS 108 / SAE A, P2   |
| 46303       | Yellow, Reflex Lens, Two Bulb                    | UBS .180  | 12V               | P2: .66A            | TurtleBack®    | FMVSS 108 / SAE A, P2   |
| 45442       | Red, Optic Lens, No Splice                       | Hard Wire | 12V               | P2: .66A            | TurtleBack®    | FMVSS 108 / SAE P2      |
| 45443       | Yellow, Optic Lens, No Splice                    | Hard Wire | 12V               | P2: .66A            | TurtleBack®    | FMVSS 108 / SAE P2      |
| 53062       | Red, Optic Lens, White Base, Side Marker         | Male Pin  | 12V               | P2: .59A            | Sentry         | FMVSS 108 / SAE P2      |
| 53063       | Yellow, Optic Lens, White Base, Side Turn/Marker | Male Pin  | 12V               | E2: 1.34A, P2: .59A | Economy        | FMVSS 108 / SAE E2, P2  |
| 53163       | Yellow, Optic Lens, Black Base, Side Turn        | Male Pin  | 12V               | E2: 1.34A           | Economy        | FMVSS 108 / SAE E2      |
| 54012       | Red, Optic Lens, Supplemental High Mount Stop    | Male Pin  | 12V               | U: 1.34A            | Economy        | FMVSS 108 / SAE U       |

LED



## MICRONOVA® LED LAMPS

*Oval or Round. These high-end LED marker lamps are useful as P2, PC, dual intensity or indicator lamps. Most varieties use no mechanical fasteners. These lamps have a super-low profile and are nearly impossible to break. If a high-end style, design and performance lamp is appealing to you, the MicroNova® series is a perfect match.*



45302

45303



47963



47982 / 47983

### MICRONOVA® OVAL LED LAMPS

| Part Number | Description                           | Connector  | Voltage (nominal) | Current Draw | Function               | Regulations / Standards |
|-------------|---------------------------------------|------------|-------------------|--------------|------------------------|-------------------------|
| 47982       | Red, Clear Lens, with Chrome Bezel    | UBS .180   | 12V               | P2: .05A     | P2 Marker              | FMVSS 108 / SAE P2      |
| 47983       | Yellow, Clear Lens, with Chrome Bezel | UBS .180   | 12V               | P2: .05A     | P2 Marker              | FMVSS 108 / SAE P2      |
| 47953       | Yellow, with Chrome Bezel             | UBS .180   | 12V               | P2: .05A     | P2 Marker              | FMVSS 108 / SAE P2      |
| 47962       | Red, with Grommet                     | UBS .180   | 12V               | P2: .05A     | P2 Marker              | FMVSS 108 / SAE P2      |
| 47963       | Yellow, with Grommet                  | UBS .180   | 12V               | P2: .05A     | P2 Marker              | FMVSS 108 / SAE P2      |
| 45282       | Red, Surface Mount                    | UBS .180   | 12V               | PC: .05A     | PC Marker @ 45 Degrees | FMVSS 108 / SAE PC      |
| 45302       | Red, Surface Mount                    | Hard Shell | 12V               | PC: .05A     | PC Marker @ 45 Degrees | FMVSS 108 / SAE PC      |
| 45283       | Yellow, Surface Mount                 | UBS .180   | 12V               | PC: .05A     | PC Marker @ 45 Degrees | FMVSS 108 / SAE PC      |
| 45303       | Yellow, Surface Mount                 | Hard Shell | 12V               | PC: .05A     | PC Marker @ 45 Degrees | FMVSS 108 / SAE PC      |



| Part Number | Description                          | Connector     | Voltage (nominal) | Current Draw | Function               | Regulations / Standards |
|-------------|--------------------------------------|---------------|-------------------|--------------|------------------------|-------------------------|
| 47972       | Red, with Grommet                    | UBS .180      | 12V               | PC: .05A     | PC Marker @ 45 Degrees | FMVSS 108 / SAE PC      |
| 47973       | Yellow, with Grommet                 | UBS .180      | 12V               | PC: .05A     | PC Marker @ 45 Degrees | FMVSS 108 / SAE PC      |
| 49372       | Red, with Grommet, Dual Intensity    | Slimline .180 | 12V               | P2: .05A     | Auxiliary Signal       | FMVSS 108 / SAE P2      |
| 49382       | Red, with Grommet, Dual Intensity    | UBS .180      | 12V               | P2: .05A     | Auxiliary Signal       | FMVSS 108 / SAE P2      |
| 49373       | Yellow, with Grommet, Dual Intensity | Slimline .180 | 12V               | P2: .05A     | Auxiliary Signal       | FMVSS 108 / SAE P2      |
| 49383       | Yellow, with Grommet, Dual Intensity | UBS .180      | 12V               | P2: .05A     | Auxiliary Signal       | FMVSS 108 / SAE P2      |
| 49460       | Red, Green, Clear Lens, with Grommet | UBS .180      | 12V               | .05A         | Indicator              | NA                      |
| 49202       | Red, Three Lamp Bar Kit              | UBS .180      | 12V               | P2: .16A     | Narrow Rail ID Cluster | FMVSS 108 / SAE P2      |





49332

## MICRONOVA® DOT LED LAMPS



49453

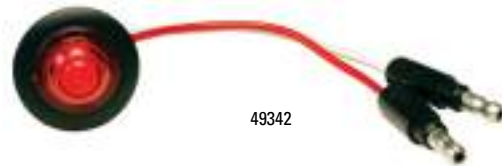

49342



49281



49413

### MICRONOVA® DOT LED LAMPS

| Part Number | Description                  | Connector | Voltage (nominal) | Current Draw | Function       | Regulations / Standards |
|-------------|------------------------------|-----------|-------------------|--------------|----------------|-------------------------|
| 49322       | Red, with Grommet            | UBS .180  | 12V               | .05A         | P2 Marker      | FMVSS 108 / SAE P2      |
| 49323       | Yellow, with Grommet         | UBS .180  | 12V               | .05A         | P2 Marker      | FMVSS 108 / SAE P2      |
| 49332       | Red, with Grommet            | UBS .180  | 12V               | .05A         | PC Marker      | FMVSS 108 / SAE PC      |
| 49333       | Yellow, with Grommet         | UBS .180  | 12V               | .05A         | P2/PC Marker   | FMVSS 108 / SAE P2, PC  |
| 49452       | Red, with Bracket            | UBS .180  | 12V               | .05A         | PC Marker      | FMVSS 108 / SAE PC      |
| 49453       | Yellow, with Bracket         | UBS .180  | 12V               | .05A         | PC Marker      | FMVSS 108 / SAE PC      |
| 49412       | Red, with Adaptor Bracket    | UBS .180  | 12V               | .05A         | PC Marker      | FMVSS 108 / SAE PC      |
| 49413       | Yellow, with Adaptor Bracket | UBS .180  | 12V               | .05A         | PC Marker      | FMVSS 108 / SAE PC      |
| 49341       | White, with Grommet          | UBS .180  | 12V               | .05A         | Position Light | ECE R7                  |
| 49342       | Red, with Grommet            | UBS .180  | 12V               | .05A         | Position Light | ECE R7                  |
| 49343       | Yellow, with Grommet         | UBS .180  | 12V               | .05A         | Side Marker    | ECE R91                 |
| 49351       | White, with Grommet          | UBS .180  | 24V               | .05A         | Position Light | ECE R7                  |
| 49352       | Red, with Grommet            | UBS .180  | 24V               | .05A         | Position Light | ECE R7                  |
| 49353       | Yellow, with Grommet         | UBS .180  | 24V               | .05A         | Side Marker    | ECE R91                 |
| 49262       | Red, with Grommet            | UBS .180  | 12V/24V           | .03A         | PC             | FMVSS 108 / SAE PC      |
| 49282       | Red, with Grommet            | UBS .180  | 12V/24V           | .03A         | Position Light | ECE R7                  |
| 49263       | Yellow, with Grommet         | UBS .180  | 12V/24V           | .03A         | PC             | FMVSS 108 / SAE PC      |
| 49283       | Yellow, with Grommet         | UBS .180  | 12V/24V           | .03A         | Side Marker    | ECE R91                 |
| 49281       | White, with Grommet          | UBS .180  | 12V/24V           | .03A         | Position Light | ECE R7                  |





| Part Number | Description                           | Connector | Voltage (nominal) | Current Draw        | Function         | Regulations / Standards |
|-------------|---------------------------------------|-----------|-------------------|---------------------|------------------|-------------------------|
| 49362       | Red, with Grommet, Dual Intensity     | UBS .180  | 12V               | High .05A, Low .02A | Auxiliary Signal | FMVSS 108 / SAE P2      |
| 49363       | Yellow, with Grommet, Dual Intensity  | UBS .180  | 12V               | High .05A, Low .02A | Auxiliary Signal | FMVSS 108 / SAE P2      |
| 60824       | Green, with Grommet                   | UBS .180  | 12V               | .05A                | Indicator        | NA                      |
| 60721       | White, with Hooded Grommet            | UBS .180  | 12V/24V           | .03A                | License          | FMVSS 108 / SAE L       |
| 60861       | White, with Hooded Grommet            | Deutsch®  | 12V/24V           | .03A                | License          | FMVSS 108 / SAE L       |
| 60661       | White, with Adaptor Bracket           | UBS .180  | 12V/24V           | .03A                | License          | FMVSS 108 / SAE L       |
| 60651       | White, Bracket Mount                  | UBS .180  | 12V/24V           | .03A                | License          | FMVSS 108 / SAE L       |
| 60711       | White, Bracket Kit (Bracket and Lamp) | UBS .180  | 12V/24V           | .03A                | License          | FMVSS 108 / SAE L       |
| 60671       | White, Integrated Clear Bracket       | UBS .180  | 12V/24V           | .03A                | License          | FMVSS 108 / SAE L       |
| 60701       | White, Vertical Mount Kit, Black      | UBS .180  | 12V/24V           | .03A                | License (43962)  | FMVSS 108 / SAE L       |
| 60681       | White, Vertical Mount Kit, Gray       | UBS .180  | 12V/24V           | .03A                | License (43690)  | FMVSS 108 / SAE L       |
| 60781       | White, Vertical Mount Kit, Gray       | UBS .180  | 12V/24V           | .03A                | License (42332)  | FMVSS 108 / SAE L       |
| 60681       | White, Vertical Mount Kit, Black      | UBS .180  | 12V/24V           | .03A                | License (42332)  | FMVSS 108 / SAE L       |
| 60691       | White, Horizontal Mount Kit, Black    | UBS .180  | 12V/24V           | .03A                | License (42162)  | FMVSS 108 / SAE L       |
| 60831       | White, with Grommet                   | Deutsch®  | 9-32V             | .03A                | Task Light       | ECE R7                  |

# 01

## CLEARANCE / MARKER LAMPS

*FEUX DE GABARIT / POSITION*

*LÁMPARAS DE GÁLIBO /  
DEMARCADORA*

**MICRONOVA® DOT LED  
CLEARANCE/MARKER LAMP**

Available in PC and P2 versions with .180 bullet or Deutsch® connectors • Sleek aerodynamic styling extends less than 3/8" from mounted surface • No fasteners required

**P2 RATED:**

|         |                    |               |
|---------|--------------------|---------------|
| 49322   | Red, w/ Grommet    |               |
| 49322-5 | Red, w/ Grommet    | <b>RETAIL</b> |
| 49323   | Yellow, w/ Grommet |               |
| 49323-5 | Yellow, w/ Grommet | <b>RETAIL</b> |

**PC RATED:**

|       |                            |           |
|-------|----------------------------|-----------|
| 49452 | Red, w/ Bracket            | <b>PC</b> |
| 49453 | Yellow, w/ Bracket         | <b>PC</b> |
| 49332 | Red, w/ Grommet            | <b>PC</b> |
| 49333 | Yellow, P2/PC w/ Grommet   | <b>PC</b> |
| 49412 | Red, w/ Adapter Bracket    | <b>PC</b> |
| 49413 | Yellow, w/ Adapter Bracket | <b>PC</b> |

**ECE RATED:**

|       |  |                           |
|-------|--|---------------------------|
| 49341 | White, w/ Grommet                        | <b>ECE</b>                |
| 49342 | Red, w/ Grommet                          | <b>ECE</b>                |
| 49343 | Yellow, w/ Grommet                       | <b>ECE</b>                |
| 49351 | White, w/ Grommet                        | <b>ECE</b> <b>24 VOLT</b> |
| 49352 | Red, w/ Grommet                          | <b>ECE</b> <b>24 VOLT</b> |
| 49353 | Yellow, w/ Grommet                       | <b>ECE</b> <b>24 VOLT</b> |
| 60831 | White, w/ Grommet and Deutsch® Connector | <b>ECE</b> <b>24 VOLT</b> |

**MULTI VOLT:**

|       |                    |                     |
|-------|--------------------|---------------------|
| 49262 | Red, w/ Grommet    | <b>PC MULTI</b>     |
| 49282 | Red, w/ Grommet    | <b>PC MULTI ECE</b> |
| 49263 | Yellow, w/ Grommet | <b>PC MULTI</b>     |
| 49283 | Yellow, w/ Grommet | <b>PC MULTI ECE</b> |
| 49281 | Clear, w/ Grommet  | <b>PC MULTI ECE</b> |

**Material:** Lens - Acrylic; Bracket - Polycarbonate; Grommet - PVC

**Regulations / Standards:** FMVSS 108, ECE / SAE P2, P3, PC

**Finish:** Red, Yellow, White

**Volts / Amps:** 12V / .05A  
24V / .05A  
9-32V / .03A

**Brackets:** 42110, 94350, 42063

**VMRS Code:** 034-004-253

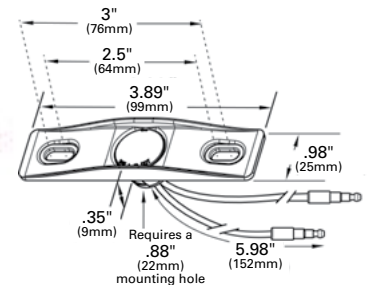
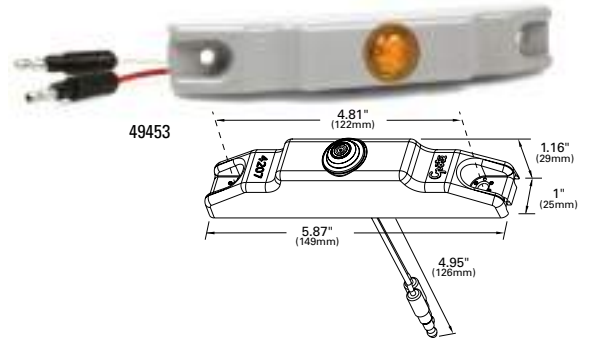
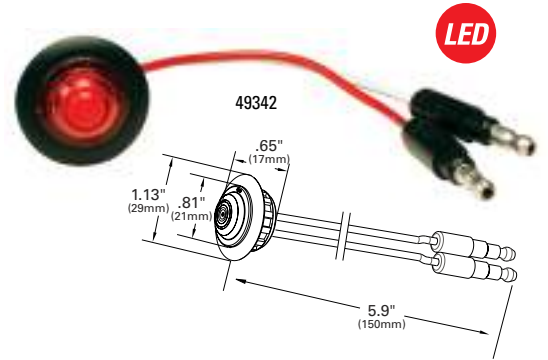

**DUAL INTENSITY MICRONOVA® DOT LED  
CLEARANCE/MARKER LAMP**

Dual Intensity allows for better visibility • Hermetic lens-to-housing seal • Encapsulant potting for total circuit board protection against vibration and corrosion • Sleek aerodynamic styling, small size fits in narrow applications

|       |                              |
|-------|------------------------------|
| 49362 | Red, w/ Grommet, Standard    |
| 49363 | Yellow, w/ Grommet, Standard |

**Material:** Lens - Acrylic; Grommet - PVC

**Regulations / Standards:** FMVSS 108 / SAE P2

**Finish:** Red / Black ; Yellow / Black

**Volts / Amps:** High - 12V / .05A; Low - 12V / .02A;

**VMRS Code:** 034-004-253

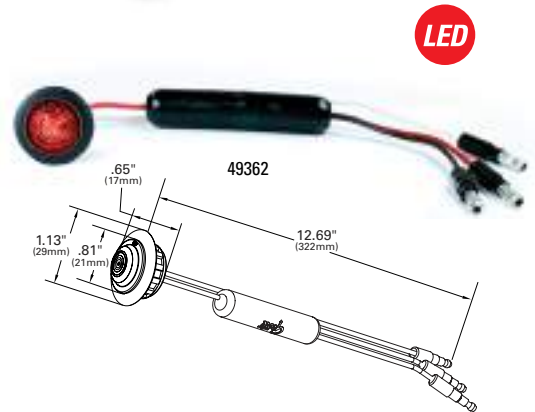

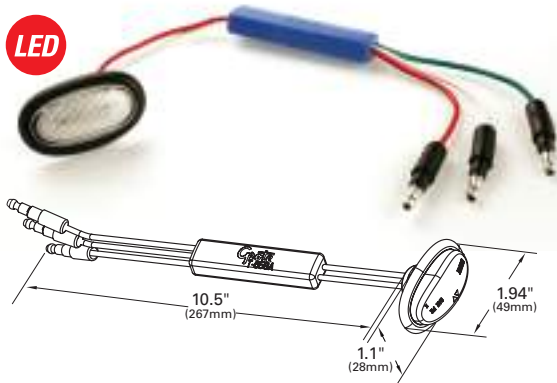
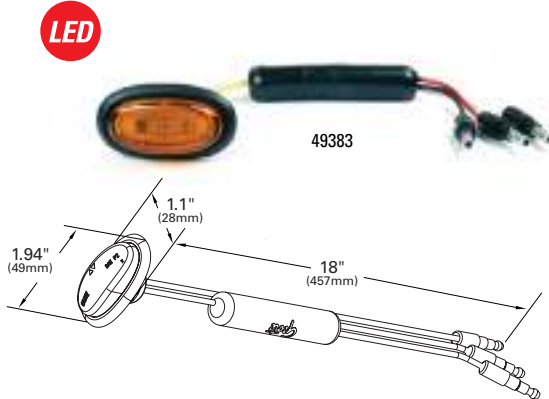
**MICRONOVA® LED CLEARANCE/MARKER LAMP**

Low profile makes lamp less susceptible to damage • Small size fits narrow applications • All PC versions meet requirements when mounted at 45° angle

- 47982** Red, Clear Lens w/ Chrome Bezel  
**47952** Red, w/ Chrome Bezel  
**47952-5** Red, w/ Chrome Bezel **RETAIL**  
**47953** Yellow, w/ Chrome Bezel  
**47953-5** Yellow, w/ Chrome Bezel **RETAIL**  
**47983** Yellow, Clear Lens w/ Chrome Bezel  
**47962** Red, w/ Grommet  
**47963** Yellow, w/ Grommet

**PC RATED:**

- 45282** Red, Surface Mount **PC**  
**45283** Yellow, Surface Mount **PC**  
**47972** Red, w/ Grommet **PC**  
**47973** Yellow, w/ Grommet **PC**  
**45302** Red, w/ Hardshell **PC**  
**45303** Yellow, w/ Hardshell **PC**

**Material:** Lens - Acrylic; Bracket - Polycarbonate; Grommet - PVC

**Regulations / Standards:** FMVSS 108 / SAE P2, PC

**Finish:** Red / Yellow / Chrome

**Volts / Amps:** 12V / .05A

**Pigtail:** 68580

**Accessory:** Bezel Chrome 93803; Mounting Gasket: 94220

**Bracket:** 42110

**VMRS Code:** 034-004-253

**DUAL INTENSITY MICRONOVA® LED CLEARANCE/MARKER LAMP**

Dual Intensity enhances signaling visibility and safety • Small size fits in narrow applications • No exposed fasteners

- 49372** Red, w/ Grommet, Slim-Line .180  
**49373** Yellow, w/ Grommet, Slim-Line .180  
**49382** Red, w/ Grommet, Standard .180  
**49383** Yellow, w/ Grommet, Standard .180

**Material:** Lens - Acrylic; Grommet - PVC

**Regulations / Standards:** FMVSS 108 / SAE P2

**Finish:** Red, Yellow

**Volts / Amps:** 12V / .05A

**Brackets:** 42110

**VMRS Code:** 034-004-253

**MICRONOVA® RED/GREEN INDICATOR LAMP**

Suitable for bright sunlight applications • Dual color circuiting molded into pigtail with bullet connectors • Clear lens with Red / Green LEDs • No exposed fasteners

- 49460** Red/Green, Clear Lens w/ Grommet

**Material:** Lens - Clear; Grommet - Polycarbonate

**Ingress Protection:** IP69K

**Volts / Amps:** 12V

**VMRS Code:** 034-004-253



### MICRONOVA® DOT LED INDICATOR LAMP

Durable one-piece LED lamp • No mounting hardware required • Hardwired with .180 standard UBS plug connectors for maximum performance



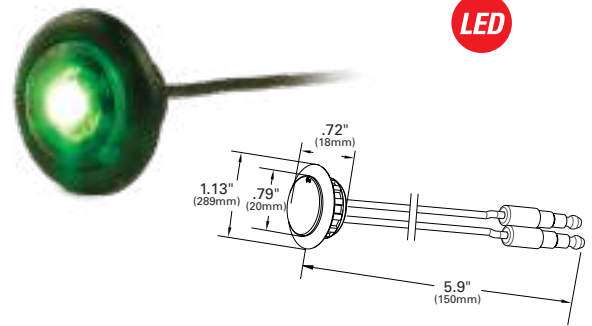

**60824** Green, w/ Grommet

**Material:** Polycarbonate  
**Finish:** Green  
**Voltage Amp:** 12V / .05A  
**Brackets:** 42110, 94350  
**VMRS Code:** 034-004-253



### SUPERNOVA® 2" LED CLEARANCE/MARKER LAMP

Uses same UBS double-seal pigtail as incandescent for quick Plug-and-Go® retrofit • Tin-plated, solid-brass terminals are sealed to housing to resist corrosion and eliminate failure causing leak paths

**47112** Red  
**47113** Yellow  
**47332** Red   
**47333** Yellow   
**46132** Red   
**46133** Yellow 

**ABS LAMP:**  
**78433** Yellow

**Material:** Polycarbonate  
**Regulations / Standards:** FMVSS 108 / SAE P2, PC, P3  
**Finish:** Red / Yellow  
**Volts / Amps:** 12V / .06A  
Red - 24V / .03A  
Yellow - 24V / .04A  
**Bracket:** 43690, 43150, 43152, 43153, 43532, 43760, 42180  
**Grommet:** 92120, 92150, 93760  
**Pigtail:** 66851, 67001, 66850, 66801, 67050, 66800, 66840  
**VMRS Code:** 034-004-253

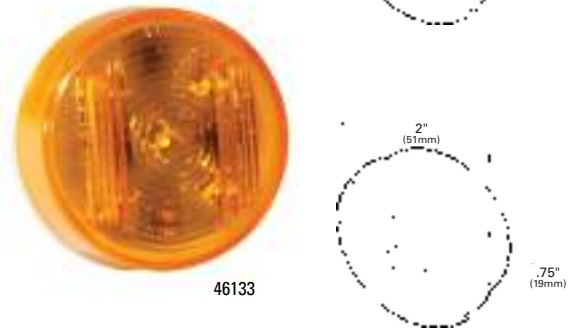
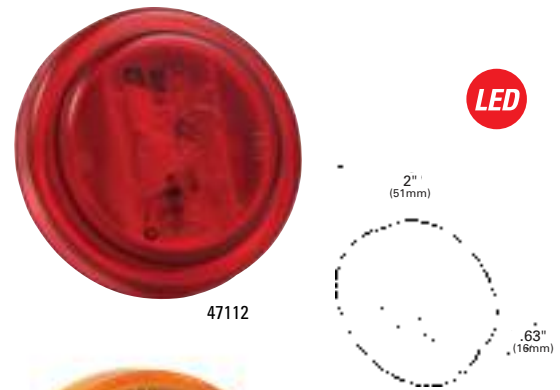

### HI COUNT® 2" 9-DIODE LED CLEARANCE/MARKER LAMP

Uses the same UBS double-seal pigtail as our incandescent version for a quick Plug-and-Go® retrofit • Twist-on mounting for easy installation

**G3002** Red  
**G3002-5** Red   
**G3003** Yellow  
**G3003-5** Yellow 

**Material:** Polycarbonate  
**Regulations / Standards:** FMVSS 108 / SAE P2  
**Finish:** Red / Yellow  
**Volts / Amps:** Red - 12V / .04A,  
Yellow - 12V / .07A  
**Bracket:** 43690, 43150, 43152, 43153, 43532, 43760, 42180  
**Grommet:** 92120, 92150, 93760  
**Pigtail:** 66851, 67001, 66850, 66801, 67050, 66800, 66840  
**VMRS Code:** 034-004-253

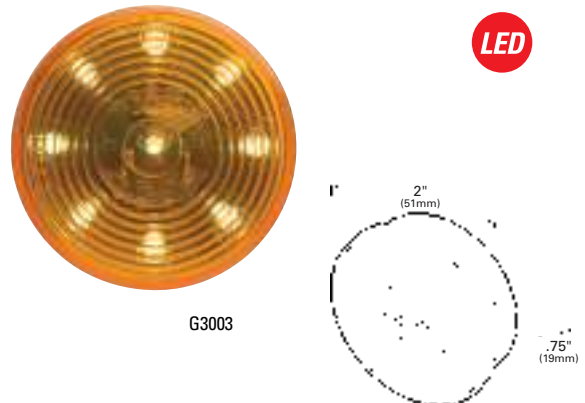

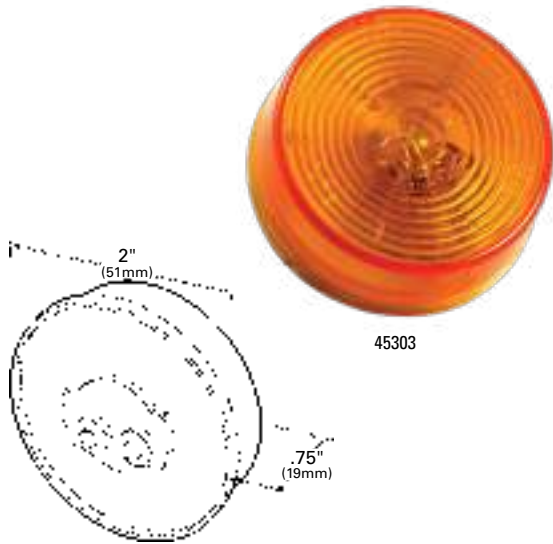

## 2" CLEARANCE/MARKER LAMP

Twist-on mounting for easy installation • Fits all popular mountings and grommets • All versions meet PC requirements when mounted at a 45° angle, recommended bracket 43690

|         |        |           |
|---------|--------|-----------|
| 45822   | Red    | PC        |
| 45822-5 | Red    | PC RETAIL |
| 45823   | Yellow | PC        |
| 45823-5 | Yellow | PC RETAIL |

### KITS:

|       |                                |    |
|-------|--------------------------------|----|
| 45062 | Red (45822 + 92120 + 67050)    | PC |
| 45063 | Yellow (45823 + 92120 + 67050) | PC |

### ABS LAMP:

|       |        |    |
|-------|--------|----|
| 78333 | Yellow | PC |
|-------|--------|----|

**Material:** Polycarbonate  
**Regulations / Standards:** FMVSS 108 / SAE P2, P3, PC, PC2  
**Finish:** Red / Yellow  
**Volts / Amps:** Bulb 2 CP: 12V / .33A  
**Bracket:** 43690, 43150, 43152, 43153, 43532, 43760, 42180  
**Grommet:** 92120, 92150, 93760  
**Pigtail:** 66851, 67001, 66850, 66801, 67050, 66800, 66840  
**VMRS Code:** 034-004-021

## SUPERNOVA® 2" BEEHIVE LED CLEARANCE/MARKER LAMP

Tin-plated, solid-brass terminals are sealed to housing to resist corrosion and eliminate failure causing leak paths • Uses same UBS double-seal pigtail as incandescent for a quick Plug-and-Go® retrofit

|       |        |
|-------|--------|
| 47212 | Red    |
| 47213 | Yellow |

**Material:** Polycarbonate  
**Regulations / Standards:** FMVSS 108 / SAE P2  
**Finish:** Red / Yellow  
**Volts / Amps:** 12V / .06A  
**Bracket:** 43690, 43150, 43152, 43153, 43532, 43760, 42180  
**Grommet:** 92120, 92150, 93760  
**Pigtail:** 66851, 67001, 66850, 66801, 67050, 66800, 66840  
**VMRS Code:** 034-004-253

## HI COUNT® 2" 9-DIODE BEEHIVE LED CLEARANCE/MARKER LAMP

Uses the same UBS double-seal pigtail as the incandescent version for a quick Plug-and-Go® retrofit • Twist-on mounting for easy installation • Fits all popular mountings and grommets

|       |        |    |
|-------|--------|----|
| G3092 | Red    | PC |
| G3093 | Yellow | PC |

**Material:** Polycarbonate  
**Regulations / Standards:** FMVSS 108 / SAE P2, PC  
**Finish:** Red / Yellow  
**Volts / Amps:** Red - 12V / .04A, Yellow - 12V / .07A  
**Bracket:** 43690, 43150, 43152, 43153, 43532, 43760, 42180  
**Grommet:** 92120, 92150, 93760  
**Pigtail:** 66851, 67001, 66850, 66801, 67050, 66800, 66840  
**VMRS Code:** 034-004-253

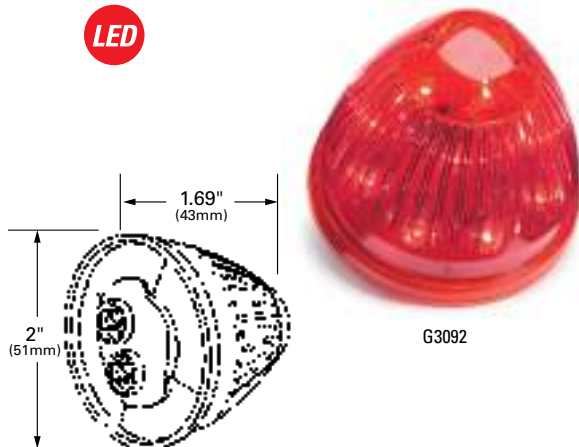
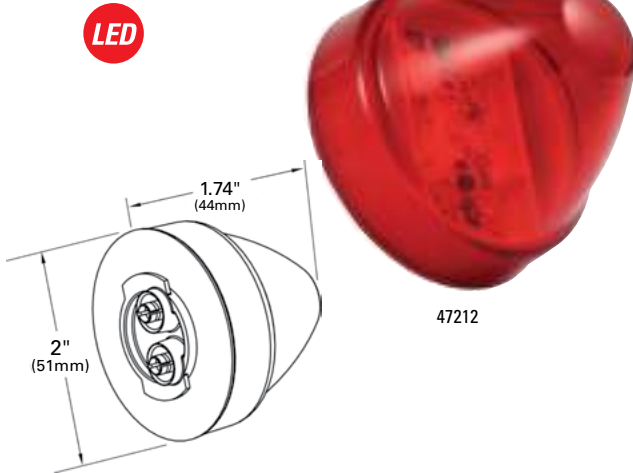



## 2" BEEHIVE CLEARANCE/MARKER LAMP

Fits popular grommet and bracket mountings • Twist-on mounting for easy installation • Meets PC function only when mounted at a 45° angle, recommended bracket 43690

- 47102 Red **PC**
- 47103 Yellow **PC**

**Material:** Polycarbonate  
**Regulations / Standards:** FMVSS 108 / SAE P2, PC  
**Finish:** Red / Yellow  
**Bulb:** 2 CP  
**Volts / Amps:** 12V / .33A  
**Bracket:** 43690, 43150, 43152, 43153, 43532, 43760, 42180  
**Grommet:** 92120, 92150, 93760  
**Pigtail:** 66851, 67001, 66850, 66801, 67050, 66800, 66840  
**VMRS Code:** 034-004-021



47103

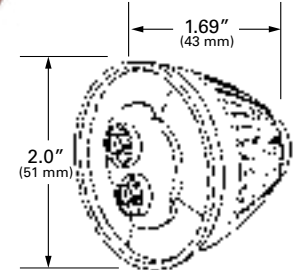

## SUPERNOVA® 2 1/2" LED CLEARANCE/MARKER LAMP

Uses same UBS double-seal pigtail as incandescent version for a quick Plug-and-Go® retrofit • Tin-plated, solid-brass terminals are sealed to housing, to resist corrosion and eliminate failure causing leak paths

- 47122 Red
- 47123 Yellow
- 47202 Red w/ Black, Theft-Resistant Flange
- 47322 Red **24 VOLT**
- 47323 Yellow **24 VOLT**
- 46142 Red **PC**
- 46143 Yellow **PC**

**KITS:**

- 47472 Red (47122 + 91400 + 67001)
- 47473 Yellow (47123 + 91400 + 67001)

**ABS LAMP:**

- 78423 Yellow

**Material:** Polycarbonate  
**Regulations / Standards:** FMVSS 108 / SAE P2, PC, P3  
**Finish:** Red / Yellow  
**Volts / Amps:** 12V / .06A  
                     24V / .03A  
**Bracket:** 43690, 43160, 43162, 43163, 43512, 43522, 93750, 42180, 42170  
**Grommet:** 91400, 91410, 92070, 91890, 91880, 92920  
**Pigtail:** 66851, 67001, 66850, 66801, 67050, 66800, 66840  
**VMRS Code:** 034-004-253



47123

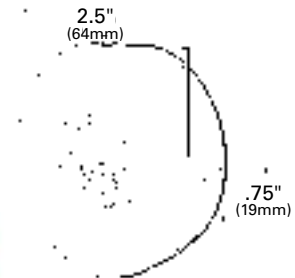

46142

LED

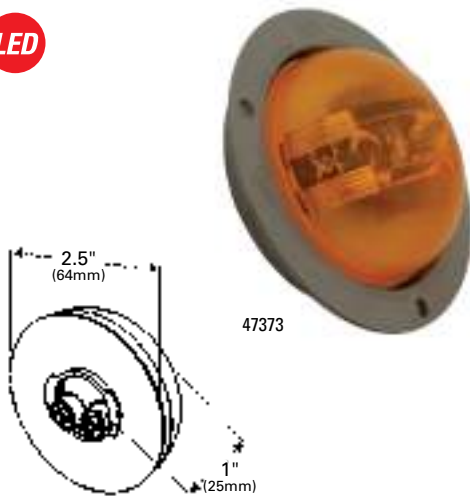
**SUPERNOVA® 2 1/2" PC RATED, LED CLEARANCE/MARKER LAMP**

Uses same UBS double-seal pigtail as incandescent for a quick Plug-and-Go® retrofit • Tin-plated, solid-brass terminals are sealed to housing, to resist corrosion and eliminate failure-causing leak paths • Available with lamp sealed to flange, for direct mounting in the side of a trailer, eliminating a leak-path into the trailer

|              |        |           |
|--------------|--------|-----------|
| <b>47232</b> | Red    | <b>PC</b> |
| <b>47233</b> | Yellow | <b>PC</b> |

**SEALED FLANGE APPLICATIONS:**

|              |                                       |           |
|--------------|---------------------------------------|-----------|
| <b>47372</b> | Red w/ Gray Theft-Resistant Flange    | <b>PC</b> |
| <b>47373</b> | Yellow w/ Gray Theft-Resistant Flange | <b>PC</b> |

**Material:** Polycarbonate**Regulations / Standards:** FMVSS 108 / SAE P2, P3, PC**Finish:** Red / Yellow**Volts / Amps:** 12V / .06A**Bracket:** 43690, 43160, 43162, 43163, 43512, 43522, 93750, 42180, 42170**Grommet:** 91400, 91410, 92070, 91890, 91880, 92920**Pigtail:** 66851, 67001, 66850, 66801, 67050, 66800, 66840**VMRS Code:** 034-004-253

LED

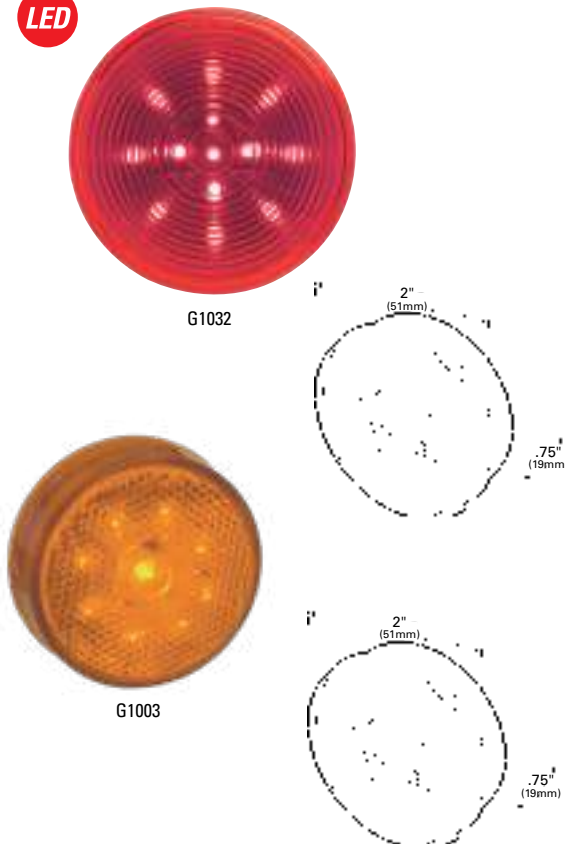
**HI COUNT® 2 1/2" 9-DIODE LED CLEARANCE/MARKER LAMP**

Uses the same UBS double-seal pigtail as the incandescent version for a quick Plug-and-Go® retrofit • Twist-on mounting for easy installation • Fits all popular mountings and grommets

**OPTIC LENS:**

|                |                    |               |
|----------------|--------------------|---------------|
| <b>G1032</b>   | Red                |               |
| <b>G1032-5</b> | Red                | <b>RETAIL</b> |
| <b>G1033</b>   | Yellow             |               |
| <b>G1033-5</b> | Yellow             | <b>RETAIL</b> |
| <b>G1042</b>   | Red, Clear Lens    |               |
| <b>G1043</b>   | Yellow, Clear Lens |               |

**REFLEX LENS:**

|              |        |
|--------------|--------|
| <b>G1002</b> | Red    |
| <b>G1003</b> | Yellow |

**Material:** Polycarbonate**Regulations / Standards:** FMVSS 108 / Optic - SAE P2, Reflex - SAE A, P2**Finish:** Red / Yellow**Volts / Amps:** Red - 12V / .04A,  
Yellow - 12V / .07A**Bracket:** 43690, 43160, 43162, 43163, 43512, 43522, 93750, 42180, 42170**Grommet:** 91400, 91410, 92070, 91890, 91880, 92920**Pigtail:** 66851, 67001, 66850, 66801, 67050, 66800, 66840**VMRS Code:** 034-004-253

### HI COUNT® 2½" 9-DIODE LED CLEARANCE/MARKER LAMP

Uses the same UBS double-seal pigtail as our incandescent version for a quick Plug-and-Go® retrofit • Twist-on mounting for easy installation  
 • Fits all popular mountings and grommets

- G1092** Red
- G1093** Yellow

**Material:** Polycarbonate  
**Regulations / Standards:** FMVSS 108 / SAE P2  
**Finish:** Red / Yellow  
**Volts / Amps:** 12V / .09A  
**Bracket:** 43690, 43160, 43162, 43163, 43512, 43522, 93750, 42180, 42170  
**Grommet:** 91400, 91410, 92070, 91890, 91880, 92920  
**Pigtail:** 66851, 67001, 66850, 66801, 67050, 66800, 66840  
**VMRS Code:** 034-004-253



G1093

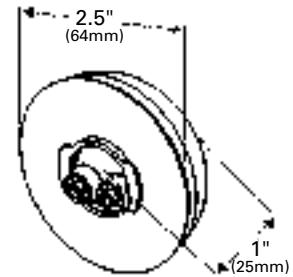

### 2½" CLEARANCE/MARKER LAMP

Hermetic lens-to-housing seal • Twist-on mounting for easy installation  
 • Fits all popular mountings and grommets • Optic lens versions meet PC function only when mounted at a 45° angle, recommended bracket: 43690; grommets: 91890 or 92920

**OPTIC LENS:**

- 45812** Red **PC**
- 45812-5** Red **PC RETAIL**
- 45813** Yellow **PC**
- 45813-5** Yellow **PC RETAIL**

**OPTIC LENS KITS:**

- 45042** Red (45812 + 91400 + 67050) **PC**
- 45043** Yellow (45813 + 91400 + 67050) **PC**

**REFLEX LENS:**

- 45832** Red
- 45833** Yellow

**BUILT-IN REFLECTOR KITS:**

- 45072** Red (45832 + 91400 + 67050)
- 45073** Yellow (45833 + 91400 + 67050)

**ABS LAMP:**

- 78343** Yellow, Optic Lens **PC**

**Material:** Lens - Acrylic; Housing - Polycarbonate  
**Regulations / Standards:** FMVSS 108 / Optic - SAE P2, P3, PC, PC2; Reflex - SAE A, P2, P3  
**Finish:** Red / Yellow  
**Volts / Amps:** Bulb: 2 CP: 12V / .33A  
 Bulb: 3 CP; Volts / Amps: 24V / .17A  
**Bracket:** 43690, 43160, 43162, 43163, 43512, 43522, 93750, 42180, 42170  
**Grommet:** 91400, 91410, 92070, 91890, 91880, 92920  
**Pigtail:** 66851, 67001, 66850, 66801, 67050, 66800, 66840  
**VMRS Code:** 034-004-021



45812

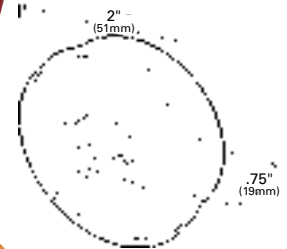

45833

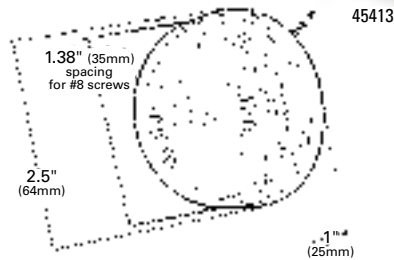

## 2 1/2" SURFACE MOUNT SINGLE-BULB CLEARANCE/MARKER LAMP

Snap-on lens for easy bulb replacement • OE replacement on Mack® MR models • Meets PC function only when mounted at a 45° angle

|         |        |                  |
|---------|--------|------------------|
| 45412   | Red    | <b>PC</b>        |
| 45412-5 | Red    | <b>PC RETAIL</b> |
| 45413   | Yellow | <b>PC</b>        |
| 45413-5 | Yellow | <b>PC RETAIL</b> |

**Material:** Polypropylene / Acrylic

**Regulations / Standards:** FMVSS 108 / SAE P2, PC

**Finish:** Red / Yellow

**Bulb:** #193, 2 CP

**Volts / Amps:** 12V / .33A

**Lens:** Red 90162, Yellow 90163

**VMRS Code:** 034-004-021

LED

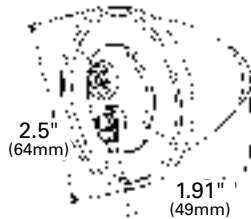

47223

## SUPERNOVA® 2 1/2" BEEHIVE LED CLEARANCE/MARKER LAMP

Tin-plated, solid-brass terminals are sealed to housing to resist corrosion and eliminate failure-causing leak paths • Uses same UBS double-seal pigtail as incandescent for a quick Plug-and-Go® retrofit

|       |        |
|-------|--------|
| 47222 | Red    |
| 47223 | Yellow |

**Material:** Polycarbonate

**Regulations / Standards:** FMVSS 108 / SAE P2

**Finish:** Red / Yellow

**Volts / Amps:** 12V / .06A

**Bracket:** 43690, 43160, 43162, 43163, 43512, 43522, 93750, 42180, 42170

**Grommet:** 91400, 91410, 92070, 91890, 91880, 92920

**Pigtail:** 66851, 67001, 66850, 66801, 67050, 66800, 66840

**VMRS Code:** 034-004-253

LED

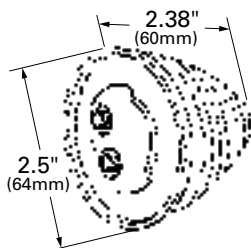

G1083

## HI COUNT® 2 1/2" 9-DIODE BEEHIVE LED CLEARANCE/MARKER LAMP

Twist-on mounting for easy installation • Fits all popular mountings and grommets

|       |        |
|-------|--------|
| G1082 | Red    |
| G1083 | Yellow |

**Material:** Polycarbonate

**Regulations / Standards:** FMVSS 108 / SAE P2

**Finish:** Red / Yellow

**Volts / Amps:** Red - 12V / .04A,  
Yellow - 12V / .07A

**Bracket:** 43690, 43160, 43162, 43163, 43512, 43522, 93750, 42180, 42170

**Grommet:** 91400, 91410, 92070, 91890, 91880, 92920

**Pigtail:** 66851, 67001, 66850, 66801, 67050, 66800, 66840

**VMRS Code:** 034-004-253

## 2 1/2" BEEHIVE CLEARANCE/MARKER LAMP

Twist-on mounting for easy installation • Fits all popular mountings and grommets • All PC versions meet requirements when mounted at 45° angle

- 45322 Red **PC**
- 45323 Yellow **PC**

**Material:** Polycarbonate  
**Regulations / Standards:** FMVSS 108 / SAE P2, PC  
**Finish:** Red / Yellow  
**Bulb:** 2 CP  
**Volts / Amps:** 12V / .33A  
**Bracket:** 43690, 43160, 43162, 43163, 43512, 43522, 93750, 42180, 42170  
**Grommet:** 91400, 91410, 92070, 91890, 91880, 92920  
**Pigtail:** 66851, 67001, 66850, 66801, 67050, 66800, 66840  
**VMRS Code:** 034-004-021

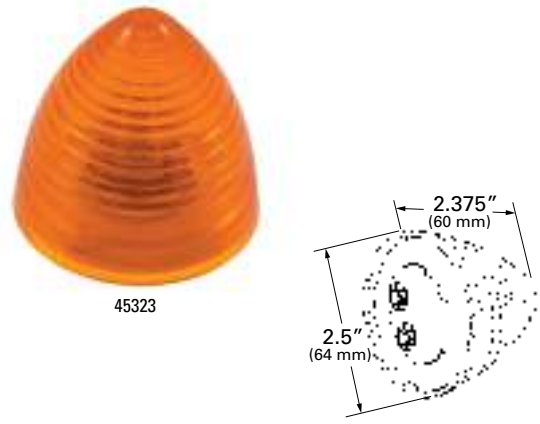

## BEEHIVE CLEARANCE/MARKER LAMP WITH FIXED-ANGLE MOUNTING BRACKET

Wide light-diffusion optic design • Fade-resistant, snap-on acrylic lens • Bracket is permanently attached • Meets PC function only when mounted at a 45° angle

- 45022 Red **PC**
- 45023 Yellow **PC**

**Material:** ABS / Steel / Acrylic  
**Regulations / Standards:** FMVSS 108 / SAE P2, PC  
**Finish:** Red / Yellow  
**Bulb:** #67, 4 CP  
**Volts / Amps:** 12V / .59A  
**Lens:** Yellow 90303  
**VMRS Code:** 034-004-021

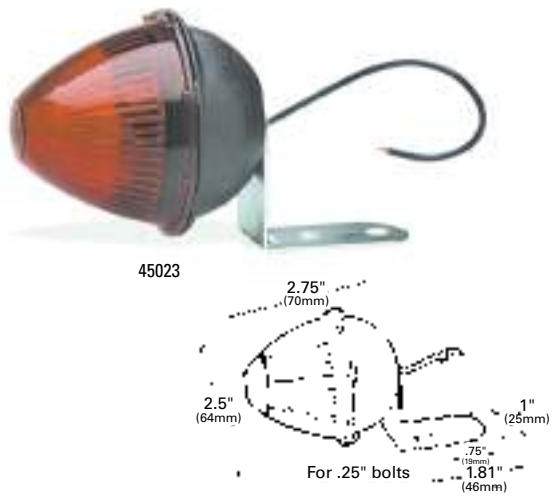

## 2 1/2" OVAL LED CLEARANCE/MARKER LAMP

Surface mount design for easy installation • Self-grounding eyelet grounds lamp when attached to metal plate (47012 and 47013)

- 45002-5 Red **RETAIL**
- 45003-5 Yellow **RETAIL**

**SELF GROUNDING:**

- 47012 Red
- 47013 Yellow

**Material:** Polycarbonate  
**Regulations / Standards:** FMVSS 108 / SAE P2, P3  
**Finish:** Red / Yellow  
**Volts / Amps:** 12V / .05A  
**VMRS Code:** 034-004-253

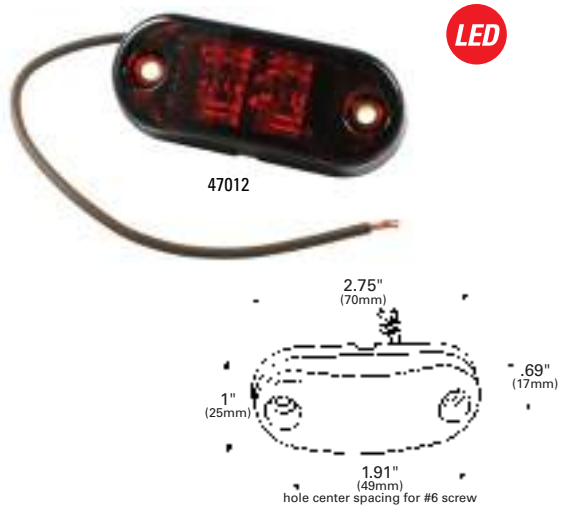



LED



47082

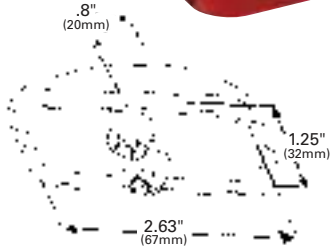

### SUPERNOVA® LED CLEARANCE/MARKER LAMP

Tin-plated, solid-brass terminals are sealed to housing, to resist corrosion and eliminate failure-causing leak paths • Uses the same UBS double-seal pigtail as incandescent for a quick Plug-and-Go® retrofit

|              |        |
|--------------|--------|
| <b>47082</b> | Red    |
| <b>47083</b> | Yellow |
| <b>47084</b> | Green  |

**Material:** Polycarbonate  
**Regulations / Standards:** FMVSS 108 / SAE P2 (N/A Green)  
**Finish:** Red / Yellow / Green  
**Volts / Amps:** 12V / .06A  
**Bracket:** 43970, 43980, 94233, 43380  
**Grommet:** 91380  
**Pigtail:** 66851, 67001, 66850, 66801, 67050, 66800, 66840  
**VMRS Code:** 034-004-253

LED



G1503

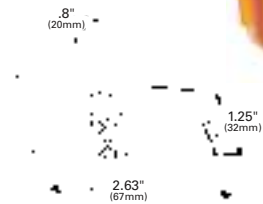

### HI COUNT® 3-DIODE LED CLEARANCE/MARKER LAMP

Uses the same UBS double-seal pigtail as the incandescent version for a quick Plug-and-Go® retrofit • Fits popular mountings and grommets

|              |        |
|--------------|--------|
| <b>G1502</b> | Red    |
| <b>G1503</b> | Yellow |

**Material:** Polycarbonate  
**Regulations / Standards:** FMVSS 108 / SAE P2  
**Finish:** Red / Yellow  
**Volts / Amps:** 12V / .06A  
**Bracket:** 43970, 43980, 94233, 43380  
**Grommet:** 91380  
**Pigtail:** 66851, 67001, 66850, 66801, 67050, 66800, 66840  
**VMRS Code:** 034-004-253

### CLEARANCE/MARKER LAMP

Uses double-seal UBS pigtail • Meets PC function only when mounted at a 45° angle, recommend bracket 43380

|                |                   |                          |
|----------------|-------------------|--------------------------|
| <b>45162</b>   | Red               | <b>PC</b> <b>24 VOLT</b> |
| <b>46412</b>   | Red               | <b>PC</b>                |
| <b>46412-5</b> | Red, Pair Pack    | <b>PC</b> <b>RETAIL</b>  |
| <b>46413</b>   | Yellow            | <b>PC</b>                |
| <b>46413-5</b> | Yellow, Pair Pack | <b>PC</b> <b>RETAIL</b>  |

#### KITS:

|                |                        |           |
|----------------|------------------------|-----------|
| <b>46422-5</b> | Red (43980 + 67050)    | <b>PC</b> |
| <b>46423-5</b> | Yellow (43980 + 67050) | <b>PC</b> |

**Material:** Polycarbonate  
**Regulations / Standards:** FMVSS 108 / SAE P2, PC  
**Finish:** Red / Yellow  
**Volts / Amps:** Bulb: 2 CP: 12V / .33A; Bulb: 3 CP: 24V / .17A  
**Bracket:** 43970, 43980, 94233, 43380  
**Grommet:** 91380;  
**Pigtail:** 66851, 67001, 66850, 66801, 67050, 66800, 66840  
**VMRS Code:** 034-004-021



46412

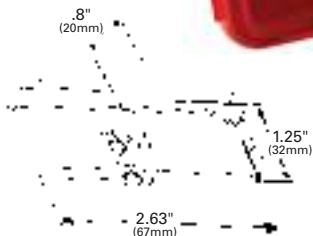



**SUPERNOVA® LED  
 CLEARANCE/MARKER LAMP**

Uses same UBS pigtail as incandescent for a quick Plug-and-Go® retrofit  
 • Meets PC function only when mounted at a 45° angle

**P2 RATED::**

- 47092** Red
- 47093** Yellow

**KITS:**

- 65202** Red (47092 + 43850)
- 65203** Yellow (47093 + 43850)

**PC RATED:**

- 47492** Red **PC**
- 47493** Yellow **PC**

**Material:** Polycarbonate  
**Regulations / Standards:** FMVSS 108 / SAE P2, PC  
**Finish:** Red / Yellow  
**Volts / Amps:** P2 Rated - 12V / .06A; PC Rated - 12V / .12A  
**Accessory:** Lamp Guard: 43120  
**Bracket:** 43780, 43783, 43850  
**Pigtail:** 66982, 66980, 66981  
**VMRS Code:** 034-004-253



**HI COUNT® 3-DIODE LED  
 CLEARANCE/MARKER LAMP**

Hermetic lens-to-housing seal • Uses the same UBS double-seal pigtail as the incandescent version for a quick Plug-and-Go® retrofit • Fits all popular mountings and grommets

- G1902** Red
- G1902-5** Red **RETAIL**
- G1903** Yellow
- G1903-5** Yellow **RETAIL**

**Material:** Polycarbonate  
**Regulations / Standards:** FMVSS 108 / SAE P2  
**Finish:** Red / Yellow  
**Volts / Amps:** 12V / .06A  
**Accessory:** Lamp Guard: 43120; Bracket: 43780, 43783, 43850  
**Pigtail:** 66982, 66980, 66981  
**VMRS Code:** 034-004-253





46743



46740

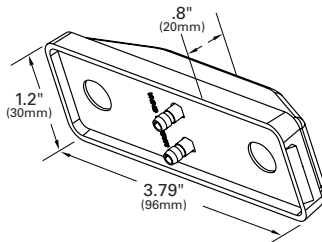

## CLEARANCE/MARKER LAMP

Narrow mounting applications • Hermetic lens-to-housing seal  
• Meets PC function only when mounted at a 45° angle

**46742** Red **PC**  
**46743** Yellow **PC**

### KITS:

**45092** Red (46742 + 43850) **PC**  
**45093** Yellow (46743 + 43850) **PC**

### ABS LAMP:

**78393** Yellow **PC**

### SPLIT LENS COLOR

**46740** Red & Yellow

**Material:** Polycarbonate  
**Regulations / Standards:** FMVSS 108 / SAE P2, P3, PC, PC2, (46740) - SAE P2  
**Finish:** Red / Yellow  
**Volts / Amps:** Bulb (2) 2 CP: 12V / .66A  
Bulb (2) 3 CP: 24V / .34A  
**Accessory:** Lamp Guard: 43120  
**Bracket:** 43780, 43783, 43850  
**Pigtail:** 66980, 66982, 66981  
**VMRS Code:** 034-004-021

LED



47502



## SUPERNOVA® LED CLEARANCE/MARKER LAMP WITH BUILT-IN REFLECTOR

Encapsulant potting for total circuit board protection • Tin-plated, solid-brass terminals are sealed to housing, to resist corrosion and eliminate failure-causing leak paths

**47502** Red  
**47503** Yellow

**Material:** Polycarbonate  
**Regulations / Standards:** FMVSS 108 / SAE A, P2  
**Finish:** Red / Yellow  
**Volts / Amps:** 12V / .06A  
**Grommet:** 93400, 93402  
**Pigtail:** 66851, 67001, 66850, 66801, 67050, 66800, 66840  
**VMRS Code:** 034-004-253



45233

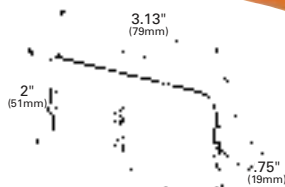

## CLEARANCE/MARKER LAMP WITH BUILT-IN REFLECTOR

Fits popular grommets, pigtails and harnesses

**45232** Red  
**45233** Yellow

**Material:** Polycarbonate  
**Regulations / Standards:** FMVSS 108 / SAE A, P2  
**Finish:** Red / Yellow  
**Volts / Amps:** Bulb: 2 CP; 12V / .33A  
**Grommet:** 93400, 93402  
**Pigtail:** 66851, 67001, 66850, 66801, 67050, 66800, 66840  
**VMRS Code:** 034-004-021

**SUPERNOVA® 3" THIN-LINE LED CLEARANCE/MARKER LAMP**

3" mounting center • Field-replaceable lens • Anti-torque design protects against over tightening and lens cracking • Wire exit holes at ends allow for flow-through harnessing • All PC versions meet requirements when mounted at a 45° angle

- 47242 Red
- 47243 Yellow
- 47362 Red

**KITS:**

- 65512 Red (47242 + 66930)
- 65513 Yellow (47243 + 66930)

**PC RATED:**

- 47462 Red
- 47463 Yellow

**ABS LAMP:**

- 78453 Yellow

**Material:** Polycarbonate  
**Regulations / Standards:** FMVSS 108 / SAE P2, PC  
**Finish:** Red / Yellow  
**Volts / Amps:** 12V / .06A (47242, 47243, 78453), 12V / .12A (47462, 47463)  
 Red - 24V / .03A; Yellow - 24V / .04A  
**Pigtail:** 66931, 66930, 66932  
**VMRS Code:** 034-004-253



47243



47462

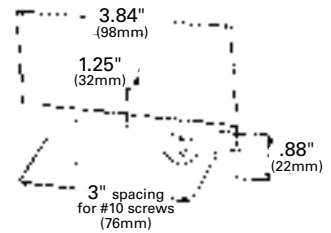

**SUPERNOVA® 3" THIN-LINE DUAL INTENSITY LED CLEARANCE/MARKER LAMP**

3" mounting center • Multi-function lamp enhances signaling visibility and safety • Compact size for narrow mounting locations • Lamp functions as a marker, clearance, identification and supplemental high-mount stop or turn lamp

- 49252 Red
- 49253 Yellow

**Material:** Polycarbonate  
**Regulations / Standards:** FMVSS 108 / SAE P2, PC  
**Finish:** Red / Yellow  
**Volts / Amps:** 14V / .02A, .06A  
**Pigtail:** 66870  
**VMRS Code:** 034-004-253



49252

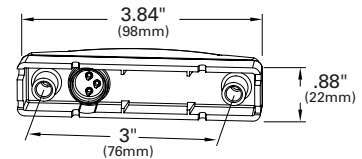

LED

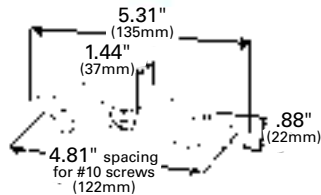

### SUPERNOVA® THIN-LINE LED CLEARANCE/ MARKER LAMP

Sealed marker lamp • Encapsulant potting for total circuit board protection  
• Thin-Line design fits narrow rails and channels • Uses UBS double-seal pigtail for maximum protection against corrosion

**46933** Yellow Lens, Yellow Body

**Material:** Polycarbonate  
**Regulations / Standards:** FMVSS 108 / SAE P2  
**Finish:** Yellow  
**Volts / Amps:** 12V / .07A  
**Bracket:** 43074  
**Pigtail:** 66931, 66930, 66932  
**VMRS Code:** 034-004-253



45252

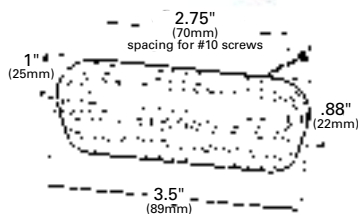

### THIN-LINE SINGLE-BULB CLEARANCE/ MARKER LAMP

Narrow rail and channel mounting • Snap-on lens for easy bulb replacement • Attached pigtail

**45252** Red  
**45252-5** Red **RETAIL**  
**45253** Yellow  
**45253-5** Yellow **RETAIL**

**Material:** Lens - Acrylic; Housing - Polycarbonate  
**Regulations / Standards:** FMVSS 108 / SAE P2  
**Finish:** Red / Yellow  
**Bulb:** #193, 2 CP  
**Volts / Amps:** 12V / .33A  
**Lens:** Red 90152, Yellow 90153  
**VMRS Code:** 034-004-021



45512

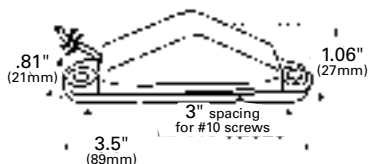

### CLEARANCE/MARKER LAMP WITH PEAK LENS

Shock-resistant bulb mount • Snap-on lens for easy bulb replacement  
All PC versions meet requirements when mounted at a 45° angle

#### BLUNT CUT:

**45512** Red **PC**  
**45513** Yellow **PC**

**Material:** Polycarbonate  
**Regulations / Standards:** FMVSS 108 / SAE P2, PC  
**Finish:** Red / Yellow  
**Bulb:** #194, 2 CP  
**Volts / Amps:** 12V / .27A  
**Lens:** Red 93252  
**VMRS Code:** 034-004-021

### ECONOMY CLEARANCE/MARKER LAMP

Snap-on lens for easy bulb replacement • Brass, ground eyelet • Compact design

- 46882 Red
- 46882-5 Red **RETAIL**
- 46883 Yellow
- 46883-5 Yellow **RETAIL**

**Material:** Lens - Polycarbonate; Housing - Polypropylene  
**Regulations / Standards:** FMVSS 108 / SAE P2  
**Finish:** Red / Yellow  
**Volts / Amps:** Bulb #194, 2 CP: 12V / .27A  
**Lens:** Red 92432, Yellow 92433  
**VMRS Code:** 034-004-021

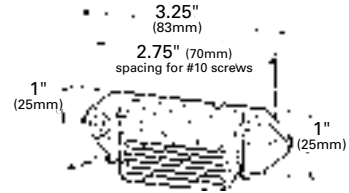

### RECTANGULAR SINGLE-BULB CLEARANCE/MARKER LAMP WITH BUILT-IN REFLECTOR

Corrosion-resistant body • Flange mounting • Boat, snowmobile, trailer, and RV applications

- 46392 Red
- 46393 Yellow
- 46393-5 Yellow **RETAIL**

**Material:** Lens - Acrylic; Housing - Polypropylene  
**Regulations / Standards:** FMVSS 108 / SAE A, P2, P3  
**Finish:** Red / Yellow  
**Volts / Amps:** 12V / .27A  
**Lens:** Red 91112, Yellow 91113  
**VMRS Code:** 034-004-021

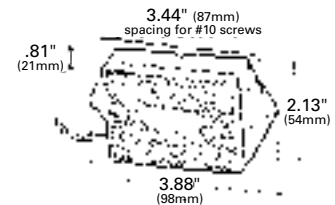

### RECTANGULAR SUBMERSIBLE CLEARANCE/MARKER LAMP WITH BUILT-IN REFLECTOR

Used with a large variety of boat, snowmobile and utility trailer lighting kits

- 46982-5 Red, Clearance/Marker **RETAIL**
- 46983-5 Yellow, Clearance/Marker **RETAIL**

**Material:** Lens - Acrylic; Housing - ABS  
**Regulations / Standards:** FMVSS 108 / SAE P2, A  
**Finish:** Red / Yellow  
**Volts / Amps:** 12V / .27A  
**Lens:** Red: 91112, Yellow 91113  
**VMRS Code:** 034-004-021

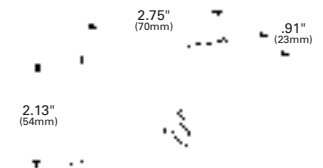

### RECTANGULAR CLEARANCE/MARKER LAMP

Chrome-plated, polycarbonate housing • 2" mounting centers  
 • 1 1/8" socket hole required

- 47052 Red
- 47053 Yellow

**Material:** Lens - Acrylic; Housing - Polycarbonate  
**Regulations / Standards:** FMVSS 108 / SAE P2  
**Finish:** Chrome / Red / Yellow  
**Volts / Amps:** Bulb #1895, 2 CP: 12V / .27A  
**VMRS Code:** 034-004-021

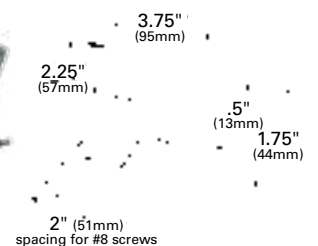

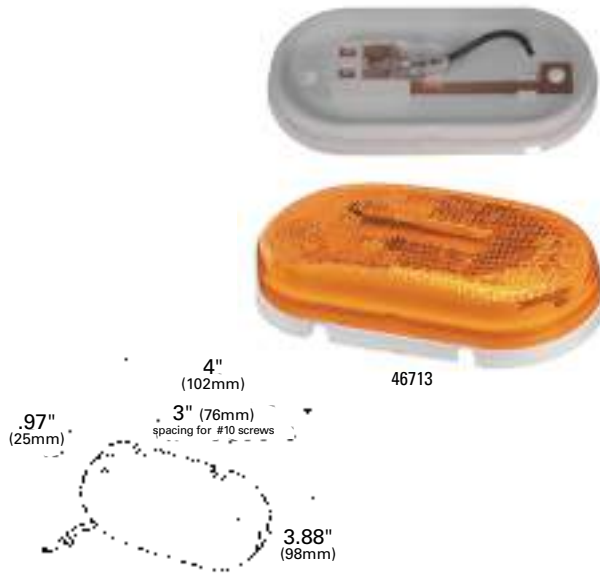

### SINGLE-BULB OVAL CLEARANCE/MARKER LAMP

Snap-on lens • Corrosion-resistant contact and ground • Reflex version is a combined side marker, clearance lamp, and reflector

#### OPTIC LENS:

46703 Yellow

#### BUILT-IN REFLECTOR:

46712 Red

46712-5 Red **RETAIL**

46713 Yellow

46713-5 Yellow **RETAIL**

**Material:** Lens - Acrylic; Housing - Polypropylene

**Regulations / Standards:** FMVSS 108 / Optic - SAE P2; Reflex - SAE A, P2

**Finish:** Red / Yellow

**Bulb:** #193, 2 CP

**Volts / Amps:** 12V / .33A

**Bracket:** 43144, 43673

**Lens:** Optic - Red 90122, Yellow 90123; Reflex - Red 90202, Yellow 90203

**VMRS Code:** 034-004-021



### TWO-BULB OVAL PIGTAIL-TYPE CLEARANCE/MARKER LAMP

Standard snap-on lens for easy bulb replacement • Two stainless steel grounds • Exclusive internal armor for additional bulb protection • Corrosion-resistant contacts • Reflex version is a combined side marker, clearance lamp, and reflector • Optic lens version meets PC function only when mounted at a 45° angle

#### OPTIC LENS:

45262 Red **PC**

45263 Yellow **PC**

#### BUILT-IN CLASS "A" REFLECTOR:

45932 Red

45933 Yellow

**Material:** Lens - Acrylic; Housing - Polypropylene

**Regulations / Standards:** FMVSS 108 / Optic - SAE P2, PC; Reflex - SAE A, P2

**Finish:** Red / Yellow

**Bulb:** (2) #1893, 2 CP

**Volts / Amps:** 12V / .66A

**Bracket:** 43144, 43673

**Pigtail:** 67120

**Lens:** Optic - Red 91572, Yellow 91573; Reflex - Red 90202, Yellow 90203

**VMRS Code:** 034-004-021



### TWO-BULB NO-SPLICE CLEARANCE/MARKER LAMP

No-splice wiring system • Internal armor for additional protection  
 • Standard snap-on lens for easy bulb replacement • Meets PC function only when mounted at a 45° angle

- 45432 Red **PC**
- 45433 Yellow **PC**

**Material:** Lens - Acrylic; Housing - Polypropylene  
**Regulations / Standards:** FMVSS 108 / SAEP2, P3, PC  
**Finish:** Red / Yellow  
**Volts / Amps:** Bulb (2) #1893, 2 CP: 12V / .66A  
**Bracket:** 43144, 43673  
**Lens:** Red 91572, Yellow 91573  
**VMRS Code:** 034-004-021

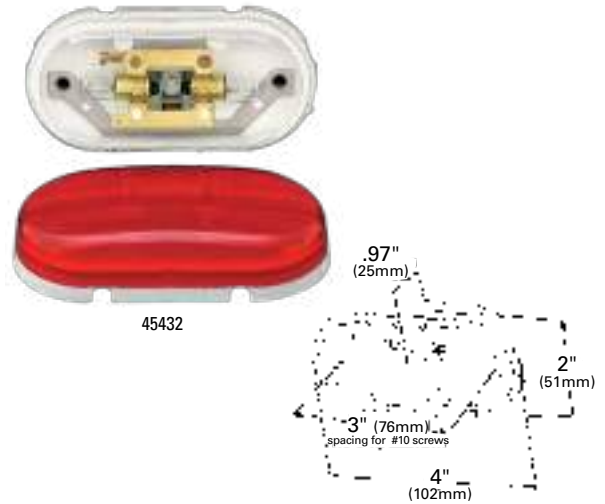

### HI COUNT® SQUARE-CORNER 13-DIODE LED CLEARANCE/MARKER LAMP

Molded snap-ring • Potted for total circuit board protection  
 • Field-replaceable lens

- G4602 Red
- G4602-5 Red **RETAIL**
- G4603 Yellow
- G4603-5 Yellow **RETAIL**

**Material:** Lens - Acrylic; Housing - Polycarbonate  
**Regulations / Standards:** FMVSS 108 / SAE P2  
**Finish:** Red / Yellow  
**Volts / Amps:** 12V / .15A  
**Bracket:** 43144, 43673  
**Lens:** Red 91962, Yellow 91963, Clear 91961  
**VMRS Code:** 034-004-253

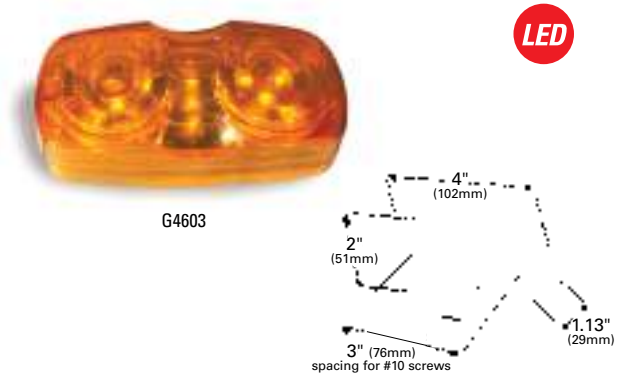

### TWO-BULB SQUARE-CORNER CLEARANCE/MARKER LAMP

Corrosion-resistant contacts • Snap-on lens for easy bulb replacement • Attached blunt cut pigtail • Meets PC function only when mounted at a 45° angle

- DURAMOLD®**
- 46792 Red **PC**
  - 46792-5 Red **PC RETAIL**
  - 46793 Yellow **PC**
  - 46793-5 Yellow **PC RETAIL**

- DIE CAST**
- 46782 Red **PC**
  - 46783 Yellow **PC**

**Materials:** Duramold: Lens - Polycarbonate; Housing - Polypropylene  
 Die-cast: Lens - Acrylic; Housing - Steel  
**Regulations / Standards:** FMVSS 108 / SAE P2, P3, PC  
**Finish:** Red / Yellow  
**Volts / Amps:** Bulb (2) #1893, 2 CP: 12V / .66A  
**Bracket:** 43144, 43673  
**Pigtail:** 67120  
**Lens:** Red 91962, Yellow 91963, Auxiliary - Clear 91961, Green 91964  
**VMRS Code:** 034-004-021

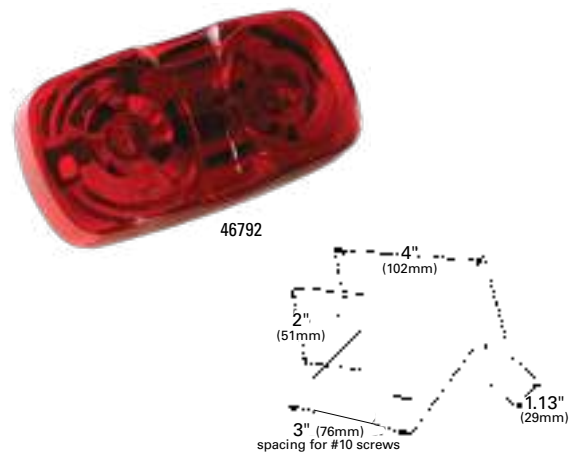

LED

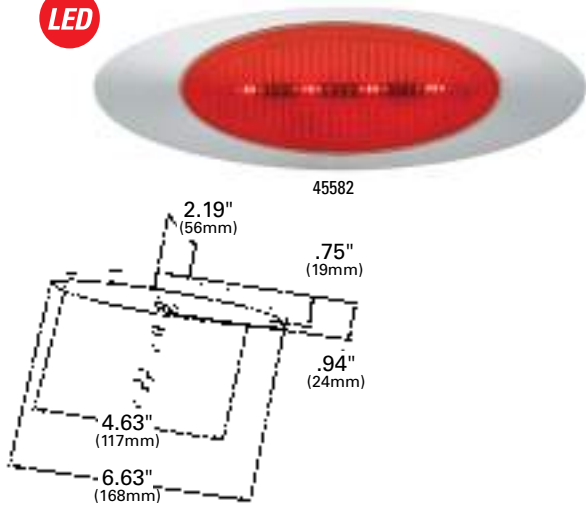
**M1 SERIES LED CLEARANCE/MARKER LAMP**

Sleek, aerodynamic styling • Corrosion-resistant, chrome-plated bezels  
 • Molded bullet kits come with two replacement mating connectors

**LAMP KITS WITH BEZEL:**

|              |  |
|--------------|--|
| <b>45582</b> | Red, .180 Molded Bullet                |
| <b>45583</b> | Yellow, .180 Molded Bullet             |
| <b>47772</b> | Red, Clear Lens, .180 Molded Bullet    |
| <b>47773</b> | Yellow, Clear Lens, .180 Molded Bullet |
| <b>45603</b> | Yellow, Metri-pack® Plug               |

**LAMP KITS WITHOUT BEZEL:**

|              |                            |
|--------------|----------------------------|
| <b>45623</b> | Yellow, .180 Molded Bullet |
| <b>45643</b> | Yellow, Metri-pack® Plug   |

**Material:** Lens - Polycarbonate; Housing - Polycarbonate; Bezel - ABS

**Regulations / Standards:** FMVSS 108 / SAE P2

**Finish:** Chrome / Red / Yellow

**Volts / Amps:** 12V / .12A

**Accessory:** Bezel Chrome 93453

**Pigtail:** 66200

**VMRS Code:** 034-004-253

LED

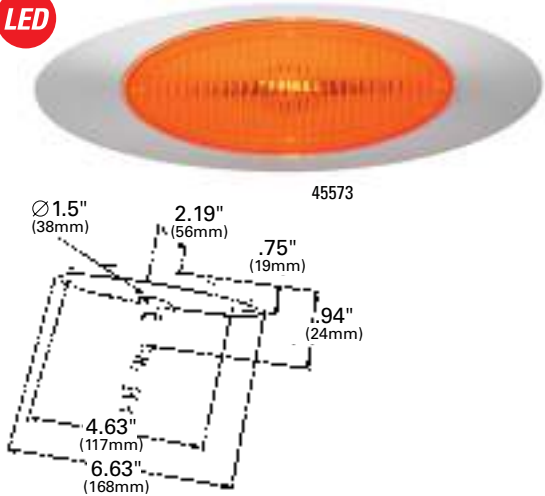
**M1 SERIES CLEARANCE/MARKER LAMP**

Sleek, aerodynamic styling • Molded bullet versions are bulb replaceable  
 • Corrosion-resistant, chrome-plated bezels • Metri-pack® versions have a hermetic lens-to-housing seal

**LAMP KITS WITH BEZEL:**

|              |                            |
|--------------|----------------------------|
| <b>45573</b> | Yellow, .180 Molded Bullet |
| <b>45593</b> | Yellow, Metri-pack® Plug   |

**LAMP KITS WITHOUT BEZEL:**

|              |                          |
|--------------|--------------------------|
| <b>45633</b> | Yellow, Metri-pack® Plug |
|--------------|--------------------------|

**Material:** Lens and Housing - Polycarbonate; Bezel - Chrome-plated ABS

**Regulations / Standards:** FMVSS 108 / SAE P2

**Finish:** Chrome / Red / Yellow

**Volts / Amps:** Bulb: #193, 2 CP: 12V / .33A; Bulb: #464, 3 CP: 24V / .17A

**Accessory:** Bezel Chrome 93453

**Pigtail:** 66200

**VMRS Code:** 034-004-253

LED

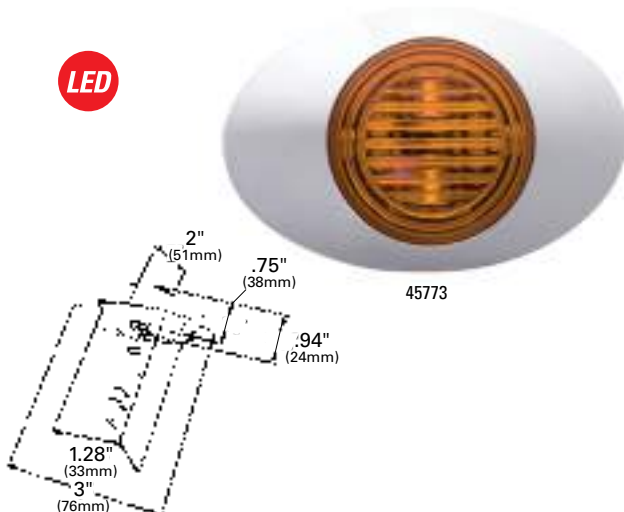
**M3 SERIES LED CLEARANCE/MARKER LAMP**

Sleek, aerodynamic styling • Corrosion-resistant, chrome-plated bezels  
 • Kits contain two replacement mating connectors

**LAMP KITS WITH BEZEL:**

|              |                            |
|--------------|----------------------------|
| <b>45773</b> | Yellow, .180 Molded Bullet |
|--------------|----------------------------|

**LAMP KITS WITHOUT BEZEL:**

|              |                            |
|--------------|----------------------------|
| <b>45793</b> | Yellow, .180 Molded Bullet |
|--------------|----------------------------|

**Material:** Lens and Housing - Polycarbonate; Bezel - Chrome-plated ABS

**Regulations / Standards:** FMVSS 108 / SAE P2

**Finish:** Yellow

**Volts / Amps:** 12V / .06A

**Pigtail:** 66200

**VMRS Code:** 034-004-253

### M3 SERIES CLEARANCE/MARKER LAMP

Sleek, aerodynamic styling • Field replaceable, bulb design • Corrosion-resistant, chrome-plated bezels • No exposed fasteners

**45763** Yellow, .180 Molded Bullet

**Material:** Lens and Housing - Polycarbonate; Bezel - Chrome-plated ABS  
**Regulations / Standards:** FMVSS 108 / SAE P2  
**Finish:** Yellow  
**Bulb:** #193, 2 CP  
**Volts / Amps:** 12V / .33A  
**Pigtail:** 66200  
**VMRS Code:** 034-004-253

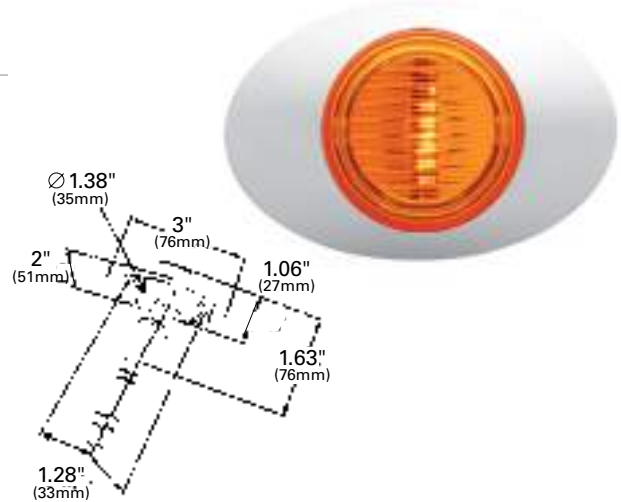

### M5 SERIES LED CLEARANCE/MARKER LAMP

Sleek, aerodynamic styling • Corrosion-resistant chrome-plated bezels • Kits contain two replacement mating connectors • Small size fits into narrow applications

**LAMP KITS WITH BEZEL:**

- 47913** Yellow, .180 Molded Bullet
- 47922** Red, Clear Lens, .180 Molded Bullet
- 47923** Yellow, Clear Lens, .180 Molded Bullet

**Material:** Lens and Housing - Polycarbonate; Bezel - Chrome-plated ABS  
**Regulations / Standards:** FMVSS 108 / SAE P2  
**Finish:** Chrome / Clear / Red / Yellow  
**Pigtail:** 66200  
**VMRS Code:** 034-004-253

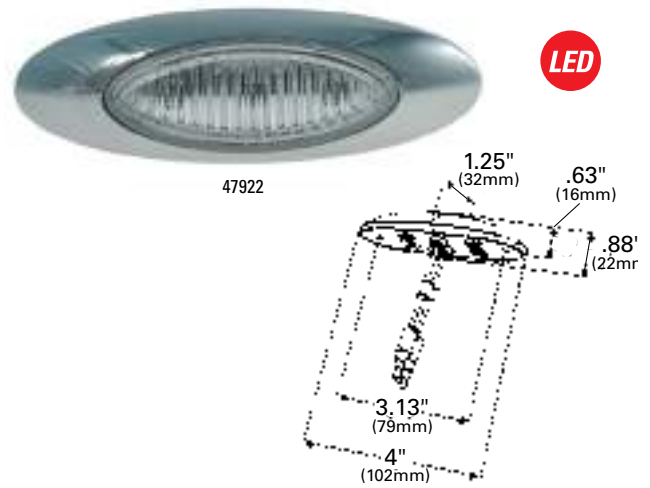

### SUPERNOVA® LOW-PROFILE LED CLEARANCE/MARKER LAMP

Sealed hardwire terminations with .180 molded, UBS Slim-Line bullets • Field replaceable lens • Requires 1 1/4" hole for mounting • Popular marker lamp on Peterbilt® trucks • Built-in reflector

**WITHOUT BEZEL:**

- 47262** Red, w/ .180 Molded Bullets
- 47263** Yellow, w/ .180 Molded Bullets

**WITH BEZEL:**

- 47252** Red, w/ .180 Molded Bullets
- 47253** Yellow, w/ .180 Molded Bullets

**Material:** Lens - Acrylic; Housing - Polypropylene; Bezel - Stainless Steel  
**Regulations / Standards:** FMVSS 108 / SAE A, P2  
**Finish:** Stainless Steel / Red / Yellow  
**Volts / Amps:** 12V / .06A  
**Lens:** Red 90072, Yellow 90073  
**VMRS Code:** 034-004-253

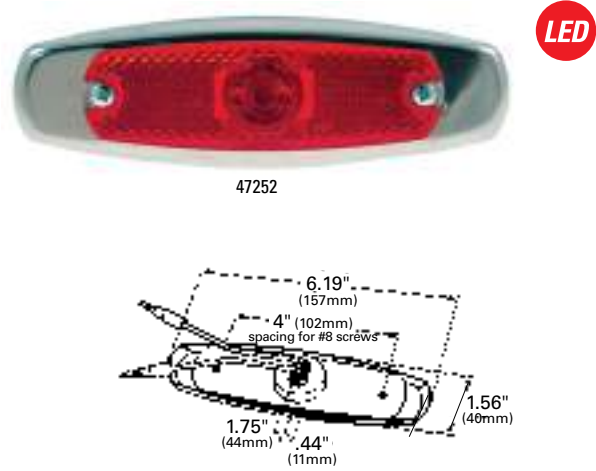



45713

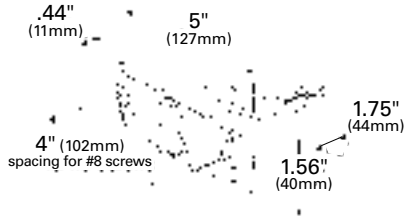

### LOW-PROFILE CLEARANCE/MARKER LAMP

Field-replaceable lens • Requires 1 1/4" socket hole for mounting  
 • Twist-in bulb socket for easy bulb replacement • Built-in reflector

#### WITHOUT BEZEL:

45712 Red  
 45713 Yellow

#### WITH BEZEL:

45662 Red  
 45663 Yellow

**Material:** Lens - Acrylic; Housing - Polypropylene; Bezel - Stainless Steel

**Regulations / Standards:** FMVSS 108 / SAE A, P2

**Finish:** Stainless Steel / Red / Yellow

**Bulb:** #194, 2 CP

**Volts / Amps:** 12V / .27A

**Pigtail:** 68380

**Lens:** Red 90072, Yellow 90073

**VMRS Code:** 034-004-021

LED



47733

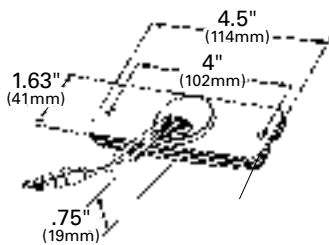

### SEALED RECTANGULAR LED CLEARANCE/MARKER LAMP

Fits standard mounting holes, no bracket required • Uses same .180 molded bullet connections as incandescent versions for a quick, easy retrofit • Replaces Truck-Lite® 18050R (red) or 18050Y (yellow)

47732 Red, w/ .180 Molded Bullets

47733 Yellow, w/ .180 Molded Bullets



**Material:** Acrylic

**Regulations / Standards:** FMVSS 108 / SAE A, P2

**Finish:** Red / Yellow

**Volts / Amps:** 12V / .06A, 24V / .06A

**VMRS Code:** 034-004-253

**SUPERNOVA® SEALED TURTLEBACK® II LED CLEARANCE/MARKER LAMP**

Tin-plated, solid-brass terminals are sealed to housing to resist corrosion and eliminate failure causing leak paths • Meets PC function only when mounted at a 45° angle • Not designed for vertical mount

**BUILT-IN REFLECTOR:**

- 47072 Red, Male Pin
- 47073 Yellow, Male Pin

**PC RATED OPTIC LENS:**

- 47162 Red, Male Pin **PC**
- 47163 Yellow, Male Pin **PC**
- 49392 Red, Hardwire **PC**
- 49393 Yellow, Hardwire **PC**

**ABS LAMP:**

- 78403 Yellow, Reflex Lens, Male Pin

**Material:** Reflex - Lens: Acrylic; Housing: Polycarbonate  
 Optic - Lens: Polycarbonate  
 Duel - Housing: Polycarbonate

**Regulations / Standards:** FMVSS 108 / Optic - SAE P2, PC; Reflex - SAE A, P2

**Finish:** Red / Yellow

**Volts / Amps:** P2 - 12V / .06A  
 PC Red - 12V / .04A, Yellow - 12V / .06A

**Bracket:** 43050

**Pigtail:** 66911, 66910, 67070, 67071

**VMRS Code:** 034-004-253

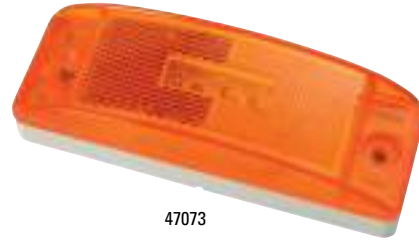

LED

47073

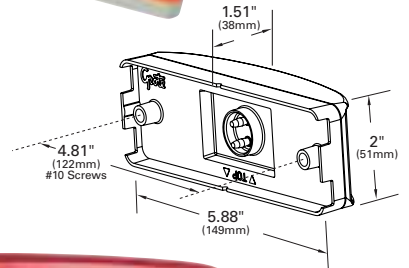

47162

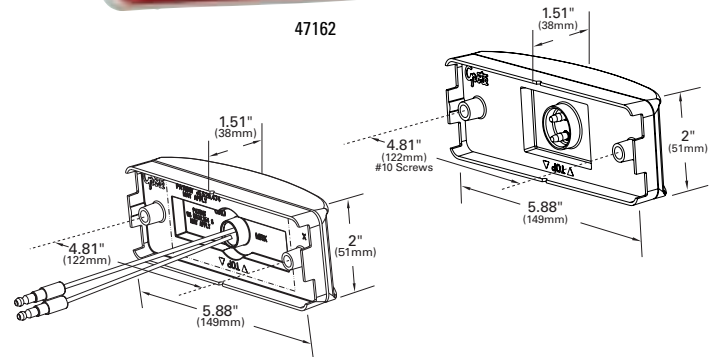

**HI COUNT® TURTLEBACK® II LED CLEARANCE/MARKER LAMP**

Hermetic lens-to-housing seal • Shock-absorbing, heat-resistant lens and lamp base • Red lamp has 8 diodes, yellow lamp has 10 diodes • Built in reflector

- G2102 Red
- G2103 Yellow

**Material:** Lens: Acrylic; Housing: Polycarbonate

**Regulations / Standards:** FMVSS 108 / SAE A, P2

**Finish:** Red / Yellow

**Volts / Amps:** Red - 12V / .12A  
 Yellow - 12V / .15A

**Bracket:** 43050

**VMRS Code:** 034-004-253



LED

G2103

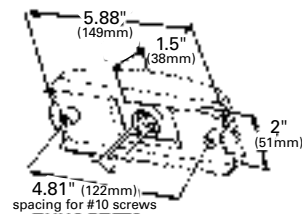



LED

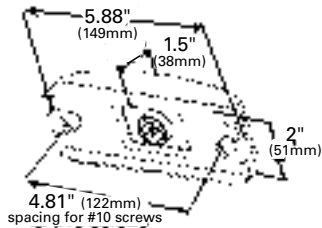

### SUPERNOVA® SEALED TURTLEBACK® II LED DUAL INTENSITY CLEARANCE/MARKER LAMP

Tin-plated, solid-brass terminals are sealed to housing to resist corrosion and eliminate failure-causing leak paths • Meets PC function when mounted at a 45° angle • Not designed for vertical mount

**54003** Yellow, Male Pin

**Material:** Polycarbonate

**Regulations / Standards:** FMVSS 108 / SAE P2, PC

**Color:** Yellow

**Voltage Amp:** 12V / .12A

**Bracket:** 43050

**Pigtail:** 66815, 66816, 66841, 66845, 67002, 67005

**VMRS Code:** 034-004-253



46832



46873

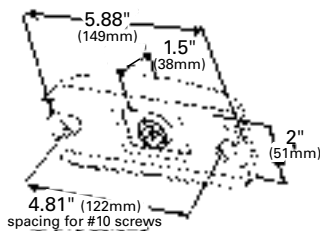

### SEALED TURTLEBACK® II CLEARANCE/MARKER LAMP

Shock-absorbing, heat-resistant lens and lamp base • Waterproof male pin connections accept UBS pigtail • Turtleback® lens design for maximum durability • Optic lens version meets PC function only when mounted at a 45° angle

#### OPTIC LENS:

**46832** Red, Male Pin

PC

**46833** Yellow, Male Pin

PC

#### REFLEX LENS:

**46872** Red, Male Pin

**46873** Yellow, Male Pin

#### ABS LAMP:

**78363** Yellow, Optic Lens, Male Pin PC

**Material:** Reflex: Lens - Acrylic; Housing - Polycarbonate  
Optic: Lens and Housing - Polycarbonate

**Regulations / Standards:** FMVSS 108 / Optic - SAE P2, P3, PC;  
Reflex - SAE A, P2

**Finish:** Red / Yellow

**Bulb:** (2) 2 CP

**Volts / Amps:** 12V / .66A

**Bracket:** 43050

**Pigtail:** 66910, 66911, 67070, 67071

**VMRS Code:** 034-004-021



**ECONOMY SEALED  
 CLEARANCE/MARKER LAMP**

Self grounding eyelet grounds lamp when attached to a metal plate  
 • Retrofits to competitor lamps easily with hot wire termination; Truck-Lite® 21201R (red) or 21201Y (yellow) • Reflex built-in

- 46072 Red
- 46073 Yellow

**KITS:**

- 46082 Red (46072 + 66360)
- 46083 Yellow (46073 + 66360)

**Material:** Acrylic  
**Regulations / Standards:** FMVSS 108 / SAE A, P2  
**Finish:** Red / Yellow  
**Bulb:** 2 CP  
**Volts / Amps:** 12V / .33A  
**Pigtail:** 66360  
**VMRS Code:** 034-004-021

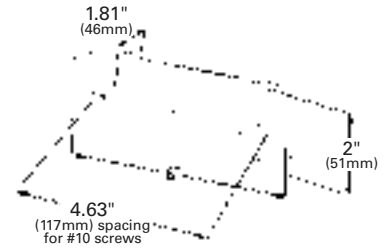

**TWO-BULB TURTLEBACK® CLEARANCE/  
 MARKER LAMP**

Two stainless steel grounds

**OPTIC LENS:**

- 45462 Red
- 45463 Yellow

**BUILT-IN REFLECTOR:**

- 46302 Red
- 46303 Yellow

**Material:** Optic: Lens - Polycarbonate; Housing - Polypropylene  
 Reflex: Lens - Acrylic; Housing - Polypropylene  
**Regulations / Standards:** FMVSS 108 / Optic - SAE P2; Reflex - SAE A, P2  
**Finish:** Red / Yellow  
**Bulb:** (2) #1893, 2 CP  
**Volts / Amps:** 12V / .66A  
**Pigtail:** 67120  
**Lens:** Optic - Red 90172, Yellow 90173; Reflex - Red 91042, Yellow 91043  
**VMRS Code:** 034-004-021

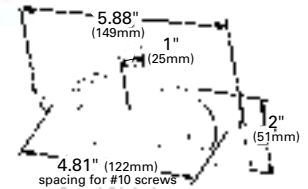

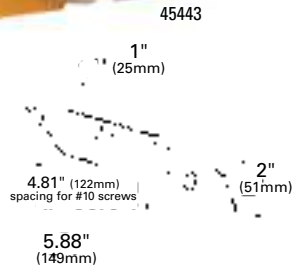

### TWO-BULB TURTLEBACK® NO-SPLICE CLEARANCE/MARKER LAMP

No-splice wiring system • Turtleback® lens design for maximum durability  
 • Corrosion-resistant contacts

45442 Red  
 45443 Yellow

**Material:** Lens - Polycarbonate; Housing - Polypropylene

**Regulations / Standards:** FMVSS 108 / SAE P2

**Finish:** Red / Yellow

**Bulb:** (2) #1893, 2 CP

**Volts / Amps:** 12V / .66A

**Lens:** Red 90172, Yellow 90173

**VMRS Code:** 034-004-021

LED

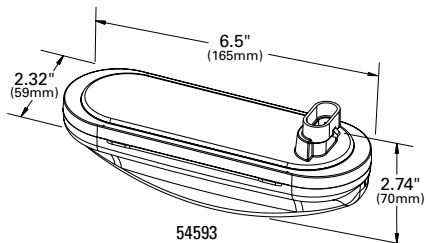

### RAZORBACK MID-POSITION FLASHING LED MARKER LAMP

Patent-pending electronic design meets all FMVSS 108 marker requirements and also flashes in concert with the turn signal circuitry to act as a mid-position flasher • 50-State-Legal flashing mid-position marker • Easily visible from the cab during operation • Fits current mounting flanges and grommets

54593 Yellow, Hardshell  
 54663 Yellow, Male Pin

**Material:** Polycarbonate

**Finish:** Yellow

**Regulations / Standards:** FMVSS 108 / SAE P2

**Volts / Amps:** 13.5V / .18A

**Brackets:** 43220, 43222, 43223, 43732, 43362, 43952, 43172, 43100, 42152, 42153

**Grommet:** 92420, 92720

**Pigtails:** 66861

**VMRS Code:** 034-003-097

### SMALL SQUARE PC-RATED CLEARANCE/MARKER LAMP

Direct replacement for Truck-Lite® 12200R • Includes gasket • Sonic sealed lens

46092 Red **PC**

**Material:** Polycarbonate

**Regulations / Standards:** FMVSS 108 / SAE P2, PC

**Finish:** Red

**Bulb:** 2 CP

**Volts / Amps:** 12V / .33A

**VMRS Code:** 034-004-021

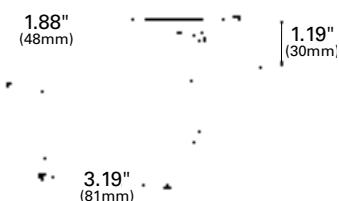

**DIE-CAST ALUMINUM  
 CLEARANCE/MARKER LAMP**

Mounts without disassembly • Holes interchange with competitive lamps for easy retrofits • Lens replaces comparable competitor models • Meets PC function only when mounted at a 45° angle

**FLAT BACK, NO SOCKET HOLE REQUIRED:**

- 46282 Red **PC**
- 46283 Yellow **PC**

**Material:** Lens - Acrylic; Housing - Aluminum  
**Regulations / Standards:** FMVSS 108 / SAE P2, PC  
**Finish:** Red / Yellow  
**Bulb:** #193, 2 CP  
**Volts / Amps:** 12V / .33A  
**Lens:** Red 90922, Yellow 90923  
**VMRS Code:** 034-004-021

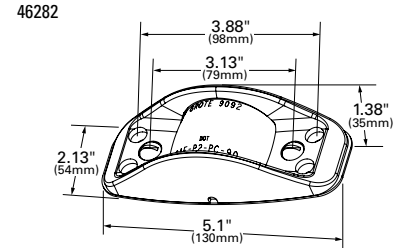

**NARROW-RAIL CLEARANCE/MARKER LAMP**

Steel housing for additional lamp protection • Two- or four-hole mounting for easy retrofits • Flat back; no need for lamp socket hole • Meets PC function only when mounted at a 45° angle

- 45172 Red **PC**
- 45173 Yellow **PC**

**Material:** Lens - Acrylic; Housing - Steel  
**Regulations / Standards:** FMVSS 108 / SAE P2, P3, PC  
**Finish:** Red / Yellow  
**Bulb:** #193, 2 CP  
**Volts / Amps:** 12V / .33A  
**Lens:** Red 90052, Yellow 90053, Auxiliary: Clear 90051  
**VMRS Code:** 034-004-021

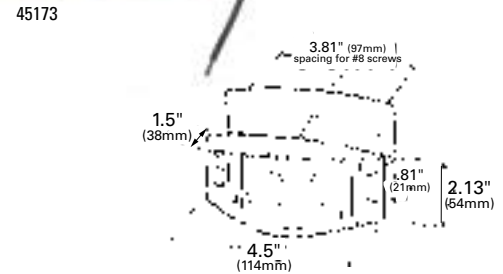

**ARMORED CLEARANCE/MARKER LAMP**

Steel housing for additional lamp protection • Two- or four-hole mounting for easy retrofits • Rear socket hole required • Meets PC function only when mounted at a 45° angle

- 45012 Red **PC**
- 45013 Yellow **PC**

**Material:** Lens - Acrylic; Housing - Steel  
**Regulations / Standards:** FMVSS 108 / SAE P2, P3, PC  
**Finish:** Red / Yellow  
**Bulb:** #67, 4 CP  
**Volts / Amps:** 12V / .59A  
**Pigtail:** 68080  
**Lens:** Red 90052, Yellow 90053; Auxiliary: Clear 90051  
**VMRS Code:** 034-004-021

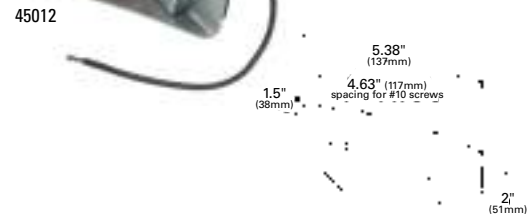



46893

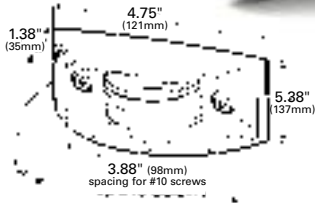

## CHROME-ARMORED CLEARANCE/MARKER LAMP

Direct interchange for competitive models • Flat back; no bulb socket hole required • Meets PC function only when mounted at a 45° angle

|         |        |           |
|---------|--------|-----------|
| 46892   | Red    | PC        |
| 46892-5 | Red    | PC RETAIL |
| 46893   | Yellow | PC        |
| 46893-5 | Yellow | PC RETAIL |

**Material:** Lens - Acrylic; Housing - Chrome-plated ABS

**Regulations / Standards:** FMVSS 108 / SAE P2, PC

**Finish:** Red / Yellow

**Bulb:** #194, 2 CP

**Volts / Amps:** 12V / .27A

**Lens:** Red 90922, Yellow 90923

**VMRS Code:** 034-004-021

LED

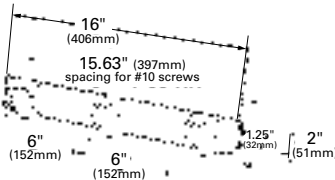

## SUPERNOVA® LOW-PROFILE LED BAR LAMP

Twist-in, locking feature • Sealed UBS harness • Uses 2 1/2" round LED replacement lamps

49162 Red

**Material:** Lens - Polycarbonate; Housing - Steel

**Regulations / Standards:** FMVSS 108 / SAE P2

**Finish:** Red

**Volts / Amps:** 12V / .18A

**Accessory:** Lamp: Red 47122; Harness: 67740

**VMRS Code:** 034-004-149

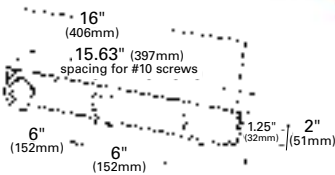

## LOW-PROFILE BAR LAMP

Uses 2 1/2" round, replaceable lamps • Twist-in, locking feature • Sealed UBS harness

49142 Red

**Material:** Lens - Polycarbonate; Housing - Steel

**Regulations / Standards:** FMVSS 108 / SAE P2

**Finish:** Red

**Bulb:** (3) 2 CP

**Volts / Amps:** 12V / .99A

**Accessory:** Harness: 67740, Lamp: Red 45812

**VMRS Code:** 034-004-149

LED

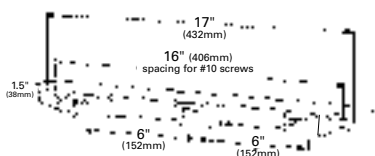

## SUPERNOVA® LED BAR LAMP

Snap-on replacement lamps • Sealed flow-through UBS harness • Rugged reinforced polycarbonate bar • Easy to install

49182 Red

**Material:** Polycarbonate

**Regulations / Standards:** FMVSS 108 / SAE P2

**Finish:** Red

**Volts / Amps:** 12V / .18A

**Accessory:** Lamp: Red 47082; Harness: 69710

**VMRS Code:** 034-004-149

### POLYCARBONATE BASE BAR LAMP

Three replaceable snap-on lamps • Sealed flow-through harness  
 • Rugged reinforced polycarbonate bar • Easy to install

**49172** Red

**Material:** Polycarbonate  
**Regulations / Standards:** FMVSS 108 / SAE P2  
**Finish:** Red  
**Bulb:** (3) 2 CP  
**Volts / Amps:** 12V / .99A  
**Accessory:** Lamp: Red 46412, Yellow 46413; Harness: 69710  
**VMRS Code:** 034-004-149

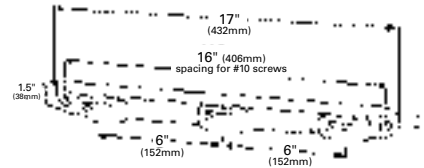

### ALUMINUM BASE BAR LAMP

Thin-line design fits narrow rails and channels • Three two-bulb replaceable snap-on lamps • Easy installation • UBS wire harness included

**49132** Red

**Material:** Lens - Polycarbonate; Housing - Aluminum  
**Regulations / Standards:** FMVSS 108 / SAE P2  
**Finish:** Red  
**Bulb:** (6) 2 CP  
**Volts / Amps:** 12V / 1.98A  
**Accessory:** Lamp: Red 46742  
**VMRS Code:** 034-004-149

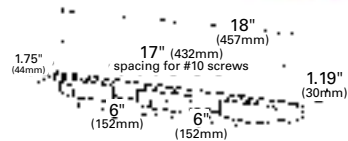

### MICRONOVA® LED BAR LAMP

Low-profile design fits narrow rail applications • Easy to install  
 • Rugged reinforced polycarbonate bar

**49202** Red

**Material:** Polycarbonate  
**Regulations / Standards:** FMVSS 108 / SAE P2  
**Finish:** Red  
**Volts / Amps:** 12V / .16A  
**Accessory:** Lamps: Red 47962  
**VMRS Code:** 034-004-149

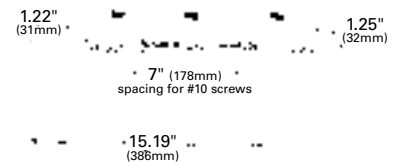

### SUPERNOVA® THIN-LINE LED BAR LAMP

Thin-Line design fits narrow rails and channels • Easy installation  
 • Sealed UBS harness included • Replaceable external guard made of formed aluminum

**49122** Red

**Material:** Lens - Polycarbonate; Housing - Aluminum  
**Regulations / Standards:** FMVSS 108 / SAE P2  
**Finish:** Red  
**Volts / Amps:** 12V / .18A  
**Branch Guard:** 43074  
**VMRS Code:** 034-004-149

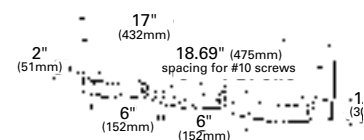



LED

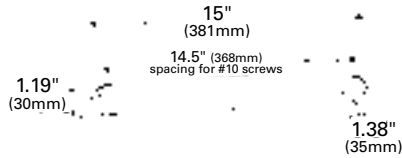

49192

**15" SLIM LED BAR LAMP**

Impact-resistant housing is sealed for moisture protection

**49192** Red  
**49223** Yellow  
**49242-5** Red, 13.5" **RETAIL**

**Material:** Polycarbonate  
**Regulations / Standards:** FMVSS 108 / SAE P2, P3  
**Finish:** Red / Yellow  
**Volts / Amps:** 12V / .25A  
**VMRS Code:** 034-004-149

LED

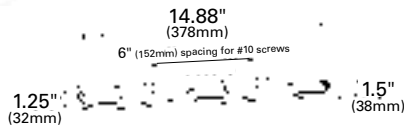
**2 1/2" OVAL LED BAR LAMP**

Impact resistant housing with sonic sealed, shock and vibration-resistant lamps • Uses three dual-diode LED lamps

**49212-5** Red **RETAIL**

**Material:** Lens and Housing - Polycarbonate; Bar - ABS  
**Regulations / Standards:** FMVSS 108 / SAE P2  
**Finish:** Red  
**Volts / Amps:** 12V / .15A  
**Accessory:** Lamp: Red 47012  
**VMRS Code:** 034-004-149

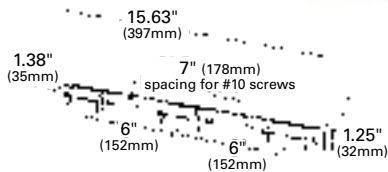
**ECONOMY BAR LAMP**

Three bulb-replaceable 46882 lamps • Formed steel bar with white enamel

**49112** Red  
**49112-5** Red **RETAIL**

**Material:** Lens - Acrylic; Housing - Polycarbonate; Bar - Formed Steel  
**Regulations / Standards:** FMVSS 108 / SAE P2  
**Finish:** Red  
**Bulb:** (3) #194, 2 CP  
**Volts / Amps:** 12V / .81A  
**Lens:** Red 92432  
**VMRS Code:** 034-004-149

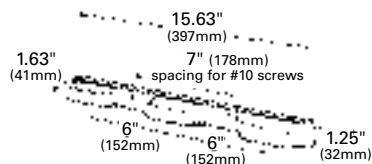
**THIN-LINE BAR LAMP**

Three bulb-replaceable 45252 lamps • Black powder-coated, formed steel bar

**49062** Red

**Material:** Lens - Acrylic; Housing - Polycarbonate; Bar - Formed Steel  
**Regulations / Standards:** FMVSS 108 / SAE P2  
**Finish:** Red  
**Bulb:** (3) #193, 2 CP  
**Volts / Amps:** 12V / .99A  
**Replacement Lens:** Red 90152  
**VMRS Code:** 034-004-149

### LOW-PROFILE BAR LAMP

Three-bulb, replaceable 45262 or 46792 lamps

- 49072 Red, Oval Style
- 49082 Red, Square Corner Style

**Material:** Lens and Housing - Polycarbonate; Housing and Bar - Polypropylene  
**Regulations / Standards:** FMVSS 108 / SAE P2  
**Finish:** Red  
**Bulb:** (6) #1893, 2 CP  
**Volts / Amps:** 12V / 1.98A  
**Lens:** Oval - 90122; Square - 91962  
**VMRS Code:** 034-004-149



49082

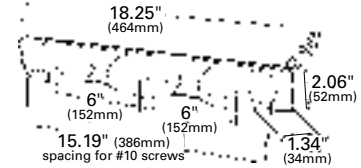

### OEM-STYLE, LARGE AERODYNAMIC CAB MARKER LAMP

3/8" thick mounting gasket • Mounting holes interchange with most popular torpedo-type cab marker lamps • Chrome-plated body, long-life bulb • Used on Ford®, Navistar®, and Freightliner® trucks • Meets side marker and front clearance requirements simultaneously

- 46823 Yellow **PC**

**Material:** Lens - Polycarbonate; Housing - Chrome-Plated ABS  
**Regulations / Standards:** FMVSS 108 / SAE P2, P3, PC  
**Finish:** Chrome / Yellow  
**Bulb:** #904, 4 CP  
**Volts / Amps:** 12V / .69A  
**Lens:** Yellow 92193  
**VMRS Code:** 034-004-021

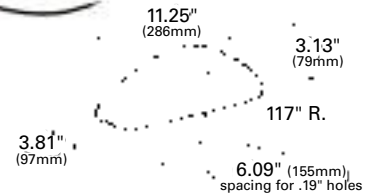

### SUPERNOVA® SMALL AERODYNAMIC LED CAB MARKER LAMP

Meets side marker and front clearance requirements simultaneously

- 47183 Yellow **PC**

**Material:** Lens - Polycarbonate; Housing - Valox®  
**Regulations / Standards:** FMVSS 108 / SAE P2, PC  
**Finish:** Yellow  
**Volts / Amps:** 12V / .12A  
**Accessory:** Chrome Bezel: 92583  
**Lens:** Yellow 92183  
**VMRS Code:** 034-004-253

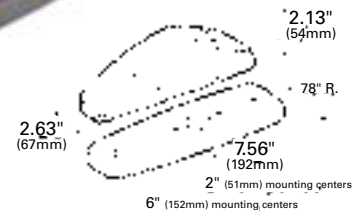

### LOW-PROFILE AERODYNAMIC CAB MARKER LAMP

Aerodynamic design • Cab marker replacement for heavy-duty Ford® trucks • Field-replaceable lens • Mounting screws included

- 46003 Yellow
- 46003-5 Yellow **RETAIL**

**Material:** Polycarbonate  
**Regulations / Standards:** FMVSS 108 / SAE P2, PC  
**Finish:** Yellow  
**Volts / Amps:** Bulb #168, 3 CP: 12V / .27A  
**Lens:** Yellow 93393  
**VMRS Code:** 034-004-021

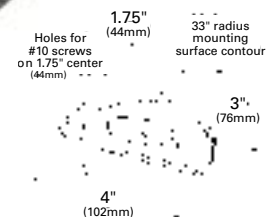

LED

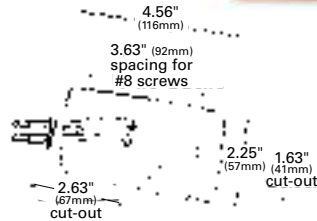

### SUPERNOVA® FLUSH-MOUNT LED CAB MARKER LAMP

Potted for total circuit board protection • Sealed hardwire connections with UBS molded .180 bullet terminals • Freightliner®, Sterling®, and Navistar® replacement

**47063** Yellow

**Material:** Polycarbonate  
**Regulations / Standards:** FMVSS 108 / SAE P2  
**Finish:** Yellow  
**Volts / Amps:** 12V / .12A  
**VMRS Code:** 034-004-253

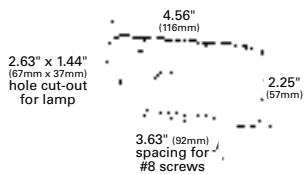

### FLUSH-MOUNT CAB MARKER LAMP

Application for visors • Hermetic lens-to-housing seal • Used on Freightliner®

**46913** Yellow

**Material:** Polycarbonate  
**Regulations / Standards:** FMVSS 108 / SAE P2  
**Finish:** Yellow  
**Pigtail:** 68380  
**VMRS Code:** 034-004-021

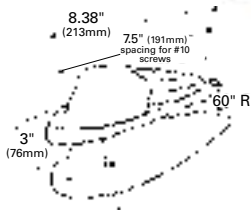

### DELUXE DIE-CAST CAB MARKER LAMP

Easy installation • Neoprene mounting pad • Chrome-plated • Meets side marker and front clearance requirements simultaneously

**45333** Yellow

**Material:** Lens - Acrylic; Housing - Chrome-Plated Zinc Die-cast  
**Regulations / Standards:** FMVSS 108 / SAE P2, P3  
**Finish:** Chrome / Yellow  
**Bulb:** #67, 4 CP  
**Volts / Amps:** 12V / .59A  
**Pigtail:** 68080  
**VMRS Code:** 034-004-021

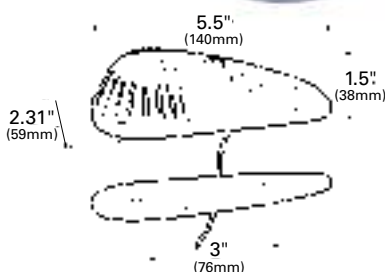

### ECONOMY CAB MARKER LAMP

Fits flat or slight contour surfaces • Replaces original equipment on Ford® trucks • Meets side marker and front clearance requirements simultaneously

**46543** Yellow **PC**  
**46543-5** Yellow **PC RETAIL**

**Material:** Lens - Acrylic; Housing - ABS  
**Regulations / Standards:** FMVSS 108 / SAE P2, PC  
**Finish:** Yellow  
**Bulb:** #67, 4 CP  
**Volts / Amps:** 12V / .59A  
**Pigtail:** 68170  
**Lens:** Yellow 91683  
**VMRS Code:** 034-004-021

### FORD® LIGHT DUTY CAB MARKER LAMP

Replaces surface mount, cab marker on Ford® F-Series trucks • Replaceable bulb design • Mounting pad and screws included

**45503** Yellow **PC**

**Material:** Lens - Polycarbonate; Housing - ABS  
**Regulations / Standards:** FMVSS 108 / SAE P2, PC  
**Finish:** Yellow  
**Bulb:** #194, 2 CP  
**Volts / Amps:** 12V / .27A  
**VMRS Code:** 034-004-021

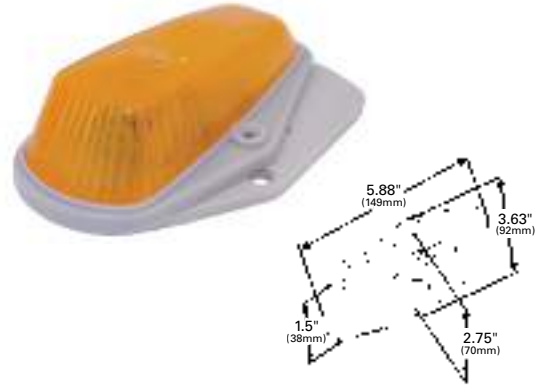

### SHOCK-RESISTANT TORPEDO-STYLE CAB MARKER LAMP

Replacement for Mack® and Kenworth® • Includes two 1/4" bolts on 9 3/4" centers for mounting

**45993** Yellow **PC**

**Material:** Lens - Acrylic; Housing - Chrome-Plated ABS  
**Regulations / Standards:** FMVSS 108 / SAE P2, PC  
**Finish:** Yellow  
**Bulb:** #67, 4 CP  
**Volts / Amps:** 12V / .59A  
**Lens:** Yellow 92773  
**VMRS Code:** 034-004-021

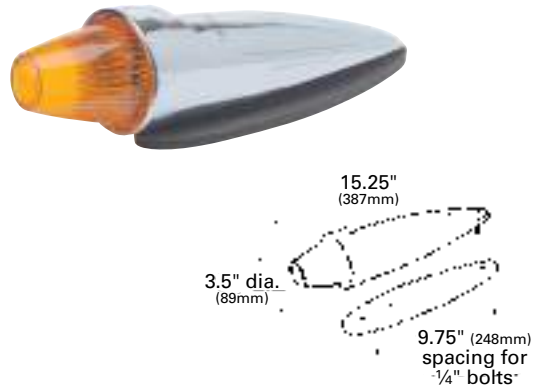

### HI COUNT® SCHOOL BUS WEDGE LED MARKER LAMP

Potted circuit board • Mounting gasket included • Blunt cut, hardwire termination • 15 diodes in both red and yellow lamps • Meets PC when mounted at a 45° only

**G5052** Red **PC**  
**G5053** Yellow **PC**  
**G5053-5** Yellow **PC RETAIL**

**Material:** Polycarbonate  
**Regulations / Standards:** FMVSS 108 / SAE P2, PC  
**Finish:** Red / Yellow  
**Volts / Amps:** 12V / .1A  
**VMRS Code:** 034-004-253





46323

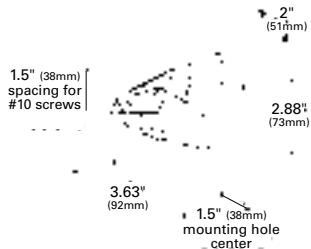

### SCHOOL BUS WEDGE MARKER LAMP

- Adaptable front/side/rear mount • Galvanized steel housing
- Fits most school bus applications

46322 Red  
46323 Yellow

**Material:** Lens - Acrylic; Housing - Galvanized Steel

**Regulations / Standards:** FMVSS 108 / SAE P2

**Finish:** Red / Yellow

**Bulb:** #168, 3 CP

**Volts / Amps:** 12V / .35A

**Lens:** Red 99912, Yellow 99913

**VMRS Code:** 034-004-021



46332



### SCHOOL BUS RECTANGULAR MARKER LAMP

- OEM-style • Fits most school bus applications • Includes mounting pad

46332 Red  
46333 Yellow

**Material:** Lens - Acrylic; Housing - Zinc

**Regulations / Standards:** FMVSS 108 / SAE P2

**Bulb:** #168, 3 CP

**Volts / Amps:** 12V / .35A

**Lens:** Red 99802, Yellow 99803

**VMRS Code:** 034-004-021



## FEMALE PIN CLEARANCE MARKER PIGTAILS

For more information on pigtail products see **Pigtails** section: page 254

### SEALED MARKER LAMP PIGTAILS

| DOUBLE SEAL:   |   |
|----------------|---|
| <b>67001</b>   | 6" Long, Ring Terminal Ground, Blunt Cut Wire               |
| <b>66850</b>   | 6" Long, Chassis Ground                                     |
| <b>66851</b>   | 6" Long, Ground Return                                      |
| SINGLE SEAL:   |   |
| <b>66801</b>   | 6" Long, Ground Return                                      |
| <b>67050</b>   | 6" Long, Ring Terminal Ground, Blunt Cut Wire               |
| <b>67050-5</b> | 6" Long, Ring Terminal Ground, Blunt Cut Wire <b>RETAIL</b> |
| <b>66840</b>   | 6" Long, Chassis Ground, Standard .180 Male                 |
| <b>66800</b>   | 6" Long, Chassis Ground, Slim-Line .180 Male                |



## MALE PIN CLEARANCE MARKER PIGTAILS

### CLEARANCE / MARKER PIGTAILS

|              |  |
|--------------|--|
| <b>66980</b> | 6" Long, Chassis Ground, Slim-Line .180 Male                     |
| <b>66981</b> | 6" Long, Universal Replacement, Blunt Cut, Ring Terminal Grommet |
| <b>66982</b> | 8" Long, Ground Return   |



## THIN LINE CLEARANCE MARKER PIGTAILS

### THIN-LINE LED PIGTAILS

|              |                                |
|--------------|--------------------------------|
| <b>66930</b> | 5" Long, Chassis Ground System |
| <b>66931</b> | 6" Long, Ground Return         |



### HIGH-MOUNT STOP LAMP PIGTAIL

|              |                                   |
|--------------|-----------------------------------|
| <b>66870</b> | 12 1/2" Long, Slim-Line .180 Male |
|--------------|-----------------------------------|



### TRIPLE-LAMP ID HARNESSSES

|              |  |
|--------------|--|
| <b>66111</b> | 54" Long, Universal Triple-ID Jumper (31"x12"x12") |
| <b>66932</b> | 60" Long, LED Triple-ID Jumper (36"x12"x12")       |

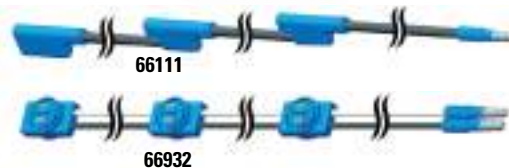

## TURTLEBACK® CLEARANCE MARKER PIGTAILS

For more information on pigtail products see **Pigtails** section: page 254

### SEALED, ECONOMY CLEARANCE/ MARKER LAMP PIGTAIL

66360 6 3/4" Long w/ 3/8" Wire Strip



### TURTLEBACK® II DOUBLE-SEAL LAMP PIGTAILS

66910 6" Long, Chassis Ground, Slim-Line .180 Male

66911 6" Long, Ground Return, Standard .180 Male

67070 2 1/2" Long, Ground Wire, Standard .180 Male

67071 Two-Wire, Standard .180 Male



### SENTRY LAMP PIGTAILS

66900 6" Long, Chassis Ground, Slim-Line .180 Male, 3 1/2" Ground, Star Ring Terminal

66904 6" Long, Ground Return, Slim-Line .180 Male

66905 6" Long, Chassis Ground, Slim-Line .180 Male



### SENTRY HIGH-MOUNT STOP PIGTAIL

66902 6" Long, Slim-Line .180 Male, 3" Ground, Star Ring Terminal



### STOP / TAIL / TURN THREE-WIRE PLUG-IN PIGTAILS FOR MALE PIN LAMPS

66815 6" Long, Ground Return, Slim-Line .180 Male

66841 8" Long, Chassis Ground, Slim-Line .180 Male

67002 11" Long, Chassis Ground, Blunt Cut Wire



### STOP / TAIL / TURN THREE-WIRE 90° PLUG-IN PIGTAILS FOR MALE PIN LAMPS

66816 6" Long, Ground Return System, 90° Plug, Slim-Line .180 Male

66845 8" Long, Chassis Ground, 90° Plug, Slim-Line .180 Male

67005 11" Long, Chassis Ground, 90° Plug, Blunt Cut Wires



## MICRONOVA® DOT MOUNTING

For more information on mounting products see **Mounting Options** section: page 264



### HOODED MICRONOVA® DOT GROMMET

94360 Black

**Material:** PVC  
**Finish:** Black



### MICRONOVA® DOT ROUND ADAPTER BRACKETS

42302 2" Round Grommet Adapter

42312 2.5" Round Grommet Adapter

42292 3" Round Flange Adapter

42282 3.5" Round Flange Adapter



### MICRONOVA® SECURITY PLATE

42063 Stainless Steel

**Material:** Stainless Steel  
**Finish:** Stainless Steel



### SURFACE MOUNT BRACKET FOR MICRONOVA® OR MICRONOVA DOT

42110 Gray

42120 Gray, Corner Radius Bracket

**Material:** Polycarbonate  
**Finish:** Gray



### MICRONOVA® SURFACE MOUNT BRACKET

42070 Gray

**Material:** Polycarbonate  
**Finish:** Gray



### MICRONOVA® DOT ADAPTER BRACKET

94350 Gray

**Material:** Polycarbonate  
**Finish:** Gray

## MICRONOVA® MOUNTING



### MICRONOVA® OVAL BEZEL

42343 Stainless Steel Bezel

**Material:** Stainless Steel  
**Finish:** Stainless Steel



### MICRONOVA® LAMP BEZEL

93803 Chrome-Plated

**Material:** ABS  
**Finish:** Chrome

## 2" CLEARANCE MARKER MOUNTING

For more information on mounting products see **Mounting Options** section: page 264



### RECESSED MOUNTING GROMMET FOR 2" ROUND LAMPS

- 92120 Open Grommet  
92150 Closed Back Grommet

**KITS:**

- 94100 Open Grommet (92120 + 67050)

**Material:** PVC  
**Finish:** Black



### TWIST-IN SURFACE MOUNT BRACKET FOR 2" AND 2 1/2" ROUND LAMPS

- 43690 Gray

**Material:** Polycarbonate  
**Finish:** Gray



### THEFT-RESISTANT MOUNTING FLANGE FOR 2" ROUND LAMPS

- 43150 Gray, Polycarbonate  
43152 Black, Polycarbonate  
43153 Chrome-Plated, ABS

**Material:** Polycarbonate/ABS  
**Finish:** Gray/Black/Chrome



### TWIST-IN SURFACE MOUNT BRACKET FOR 2" AND 2 1/2" ROUND LAMPS

- 42180 Gray

**Material:** Polycarbonate  
**Finish:** Gray



### SURFACE MOUNT BRACKET WITH GROMMET FOR 2" ROUND LAMPS

- 93760 Gray

**Material:** Polycarbonate  
**Finish:** Gray  
**Grommet:** 92120



### 4 5/8" CORNER RADIUS SURFACE MOUNT BRACKET FOR 2" AND 2 1/2" ROUND LAMPS

- 43760 Gray

**Material:** Polycarbonate  
**Finish:** Gray



### LICENSE LAMP MOUNTING BRACKET

- 43040 White

**Material:** Polycarbonate  
**Finish:** White



### 90° ANGLE MOUNTING BRACKET FOR 2" AND 2 1/2" ROUND LAMPS

- 43532 Accommodates 94100, 92120, and 92150 Grommets (2 5/16" Hole)

**Material:** Steel  
**Finish:** Black Enamel

## 2 1/2" CLEARANCE MARKER MOUNTING

For more information on mounting products see **Mounting Options** section: page 264



### RECESSED MOUNTING GROMMET FOR 2 1/2" ROUND LAMPS

- 91400 Open Grommet
- 92070 Closed Back Grommet

**KITS:**

- 94010 Open Grommet (91400 + 67050)

**Material:** PVC  
**Finish:** Black



### RECESSED MOUNTING GROMMET FOR 2 1/2" ROUND LAMPS

- 91410 Open Grommet

**KITS:**

- 94000 Open Grommet (91410 + 67050)

**Material:** PVC  
**Finish:** Black



### 45° ANGLED BEVELED-EDGE RECESSED MOUNTING GROMMET FOR 2 1/2" ROUND LAMPS

- 91880 Open Grommet
- 92920 Closed Back Grommet

**Material:** PVC  
**Finish:** Black



### SURFACE MOUNT GROMMET FOR 2 1/2" ROUND LAMPS

- 91890 Open Grommet

**Material:** PVC  
**Finish:** Black



### THEFT-RESISTANT MOUNTING FLANGE FOR 2 1/2" ROUND LAMPS

**MOUNTING FLANGE:**

- 43160 Gray, Polycarbonate
- 43162 Black, Polycarbonate
- 43163 Chrome-Plated, ABS

**PIGTAIL RETENTION CAP:**

- 93670 Gray

**Material:** Polycarbonate/ABS  
**Finish:** Gray/Black/Chrome



### SNAP-IN MOUNTING FLANGE FOR 2 1/2" ROUND LAMPS

**MOUNTING FLANGE:**

- 42170 Gray

**SECURITY RING:**

- 43823 Stainless Steel

**Material:** Polycarbonate/Stainless Steel  
**Finish:** Gray/Chrome



### SURFACE MOUNTING BRACKET WITH GROMMET FOR 2 1/2" ROUND LAMPS

- 93750 Gray

**Material:** Polycarbonate/PVC  
**Finish:** Gray/Black



### TWIST-IN SURFACE MOUNT BRACKET FOR 2" AND 2 1/2" ROUND LAMPS

- 43690 Gray

**Material:** Polycarbonate  
**Finish:** Gray



### TWIST-IN SURFACE MOUNT BRACKET FOR 2" AND 2 1/2" ROUND LAMPS

- 42180 Gray

**Material:** Polycarbonate  
**Finish:** Gray



### 4 5/8" CORNER RADIUS SURFACE MOUNT BRACKET FOR 2" AND 2 1/2" ROUND LAMPS

- 43760 Gray

**Material:** Polycarbonate  
**Finish:** Gray



### 90° ANGLE MOUNTING BRACKET FOR 2" AND 2 1/2" ROUND LAMPS

**FOR 2 1/2" LAMPS:**

- 43512 Accommodates 94010, 91400, 92070 Grommets (2 25/32" Hole)
- 43522 Accommodates 94000, 91410 Grommets (3" Hole)

**FOR 2" LAMPS:**

- 43532 Accommodates 94100, 92120, and 92150 Grommets (2 5/16" Hole)

**Material:** Steel  
**Finish:** Black Enamel



## 3" CLEARANCE MARKER MOUNTING

For more information on mounting products see **Mounting Options** section: page 264



### GROMMET FOR SMALL RECTANGULAR LAMPS

91380 Black

**Material:** PVC  
**Finish:** Black



### LICENSE LAMP BRACKET FOR SMALL RECTANGULAR LAMPS

42162 Black

**Material:** Polycarbonate  
**Finish:** Black



### BRACKET FOR SMALL RECTANGULAR LAMPS

94233 Chrome-Plated

#### KITS:

43970 Gray (+ 67050 pigtail)

43980 Chrome-Plated (+ 67050 pigtail)

**Material:** Polycarbonate/ABS  
**Finish:** Chrome/Gray



### LICENSE LAMP MOUNTING BRACKET

43960 Gray

43962 Black

**Material:** Polycarbonate  
**Finish:** Gray/Black



### HEADER-MOUNT BRACKET FOR SMALL RECTANGULAR LAMPS

#### KITS:

43380 White (42141 + 67050)

**Material:** Polycarbonate  
**Finish:** White



### LAMP GUARD FOR SMALL RECTANGULAR LAMPS

43120 Aluminum

**Material:** Aluminum  
**Finish:** Aluminum

## 3" – 5" CLEARANCE MARKER MOUNTING



### MOUNTING BRACKET FOR LARGE RECTANGULAR LAMPS

43780 Gray Bracket

43783 Chrome-Plated Bracket, ABS

#### KITS:

43390 Gray (43780 + 66981)

43790 Gray (43780 + 66980)

**Material:** Polycarbonate/ABS  
**Finish:** Gray/Chrome



### LOW PROFILE MOUNTING BRACKET

43850 Gray

**Material:** Polycarbonate  
**Finish:** Gray

## THIN LINE CLEARANCE MARKER MOUNTING



### THIN-LINE LED LAMP GUARD

43074 Aluminum

**Material:** Aluminum  
**Finish:** Aluminum

## REPLACEMENT LENSES

| LENS MODEL NUMBER | FITS LAMP    | LENS MODEL NUMBER | FITS LAMP |
|-------------------|--------------|-------------------|-----------|
| <b>90072</b>      | 45662        | <b>91042</b>      | 46302     |
|                   | 45712        | <b>91043</b>      | 46303     |
|                   | 47262        | <b>91572</b>      | 45262     |
|                   | 47252        |                   | 45432     |
| <b>90073</b>      | 45663        |                   | 49072     |
|                   | 45713        | <b>91573</b>      | 45263     |
|                   | 47263        |                   | 45433     |
|                   | 47253        |                   |           |
| <b>90122</b>      | 49072        | <b>91683</b>      | 46543     |
|                   | 46072        | <b>91962</b>      | 46782     |
| <b>90123</b>      | 46703        |                   | 46792     |
| <b>90152</b>      | 45252        |                   | G4602     |
|                   | 49062        |                   | G4602-5   |
| <b>90153</b>      | 45253        | <b>91963</b>      | 46783     |
| <b>90162</b>      | 45412        |                   | 46793     |
|                   | 49042        |                   | G4603     |
| <b>90163</b>      | 45413        | <b>91964</b>      | 46792     |
|                   | <b>90172</b> | 45462             |           |
| 45442             |              |                   | 46793     |
| <b>90173</b>      | 45463        |                   | 46793-5   |
|                   | 45443        |                   | 46782     |
|                   |              |                   | 46783     |
| <b>90202</b>      | 45932        | <b>92183</b>      | 47183     |
|                   | 46712        | <b>92193</b>      | 46823     |
| <b>90203</b>      | 45933        | <b>92433</b>      | 46883     |
|                   | 46713        | <b>92773</b>      | 45993     |
| <b>90303</b>      | 45023        | <b>99802</b>      | 46332     |
| <b>90922</b>      | 46282        | <b>99803</b>      | 46333     |
|                   | 46892        | <b>99912</b>      | 46322     |
| <b>90923</b>      | 46283        | <b>99913</b>      | 46323     |
|                   | 46293        |                   |           |
|                   | 46893        |                   |           |



90062, 90063



90072, 90073



90122, 90123



90152, 90153



90162, 90163



90172, 90173



90202, 90203



90303



90922, 90923



91042, 91043



91572, 91573



91683



91962, 91963, 91964



92183



92193



92432, 92433



92773



99802, 99803



99912, 99913

Ford® is a registered trademark of Ford Motor Company CORPORATION DELAWARE; Kenworth® is a registered trademark of PACCAR, Inc.; Freightliner® is a registered trademark of Daimler Trucks North America, LLC; Navistar® is a registered trademark of Navistar International Corporation; Deutsch® is a registered trademark of TE Connectivity Corporation; Truck-Lite® is a registered trademark of TRUCK-LITE CO., LLC; Metri-Pack®

is a registered trademark of Aptiv Technologies Limited COMPANY BARBADOS; Valox® is a registered trademark of SABIC INNOVATIVE PLASTICS IP B.V.; Mack®; Sterling®.

All product and company names are trademarks™ or registered® trademarks of their respective holders. Use of them does not imply any affiliation with or endorsement by them.

# 02

## STOP/TAIL/ TURN LAMPS

*FEUX ARRÊT / ARRIÈRE / DIRECTION*

*LÁMPARAS DE FRENO / CUARTO /  
DIRECCIONAL*



## SUPERNOVA® 4" LED STOP/TAIL/TURN LAMP

Advanced pin connection system uses tin-plated, solid-brass pin terminals

- Uses same UBS pigtail as male pin incandescent

### STOP/TAIL/TURN:

|              |   |
|--------------|---|
| <b>53252</b> | Red, Grommet Mount, Male Pin                          |
| <b>53272</b> | Red, Gray Theft-Resistant Flange, Male Pin            |
| <b>53282</b> | Red, White Theft-Resistant Flange, Male Pin           |
| <b>53292</b> | Red, Black Theft-Resistant Flange, Male Pin           |
| <b>53302</b> | Red, Stainless Steel Theft-Resistant Flange, Male Pin |
| <b>52092</b> | Red, Grommet Mount, Male Pin                          |
| <b>54622</b> | Red, Integrated Flange w/ Gasket, Male Pin            |
| <b>53552</b> | Red, Grommet Mount, Hard Shell                        |
| <b>54032</b> | Red, Gray Snap-In Flange, Hard Shell                  |
| <b>54042</b> | Red, Stainless Steel Snap-In Flange, Hard Shell       |
| <b>53532</b> | Red, Grommet Mount, Hardwire                          |

### STOP/TAIL/TURN KITS:

|              |  |
|--------------|--|
| <b>53462</b> | Red, Male Pin, (53252 + 91740 + 67002) |
| <b>53432</b> | Red, Male Pin, (53302 + 67002)         |

### AUXILIARY:

|              |  |
|--------------|--|
| <b>53253</b> | Yellow, Grommet Mount, Male Pin                          |
| <b>52093</b> | Yellow, Grommet Mount, Male Pin                          |
| <b>53293</b> | Yellow, Black Theft-Resistant Flange, Male Pin           |
| <b>53303</b> | Yellow, Stainless Steel Theft-Resistant Flange, Male Pin |
| <b>53553</b> | Yellow, Grommet Mount, Hard Shell                        |

**Material:** Lens - Acrylic; Housing - ABS; Flange - Polycarbonate / Stainless Steel

**Regulations / Standards:** FMVSS 108 / S/T/T - SAE I, P2, S, T; Auxiliary - SAE P2

**Finish:** Red / Yellow

**Volts / Amps:** Red: 12V / .306A (I, S) / .013A (T); 24V / .12A (I, S) / .0056A (T)  
 Yellow: 12V / .12A (P2); 24V / .12A (P2)

**Bracket:** 93552, 43253, 92510, 92512, 92513, 43572, 43642, 43655, 43732, 93190, 93553, 93683, 92511, 51090

**Grommet:** 91740, 91950

**Pigtail:** Male Pin: 66815, 67002, 66841, 66816, 67005, 66845

**Hard Shell:** 66861, 66862

**VMRS Code:** 034-002-059



53252

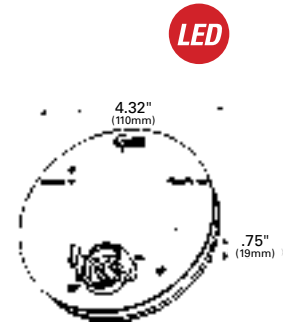

53303

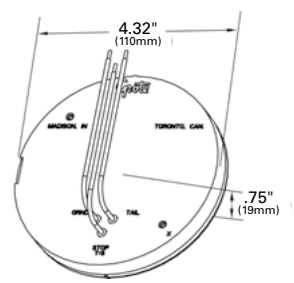
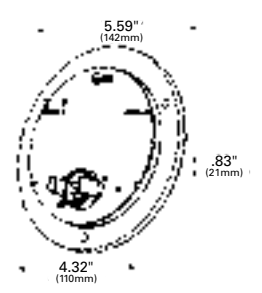

54622

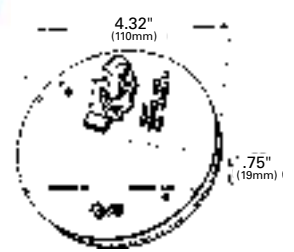

LED

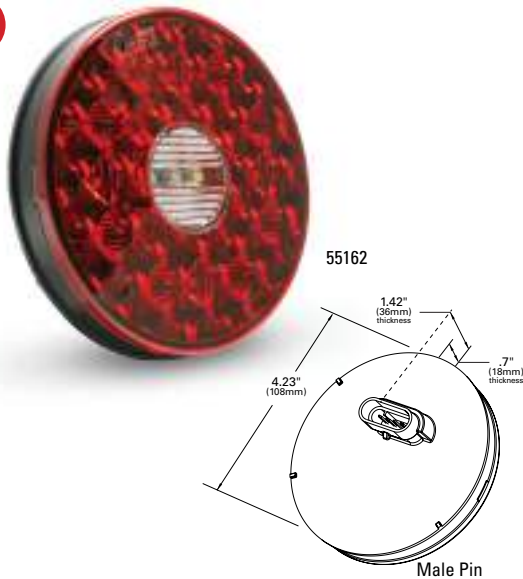

### 4" LED STOP/TAIL/TURN WITH INTEGRATED BACK-UP LAMP

Innovative, patented design combines all stop/tail/turn and back-up functions into one industry standard size lamp • Symmetrical design meets legal requirements at any mounting angle • Reduces inventory, SKUs, and carrying costs

- 55162** Red, Hard Shell  
**55202** Red, Stainless Steel, Theft Resistant Flange, Hardshell  
**55212** Red, Gray, Theft Resistant Flange, Hardshell

**Material:** Lens - Red / Clear Polycarbonate;  
 Housing - Black Polycarbonate / ABS blend;  
 Flange - Stainless Steel / Polycarbonate

**Regulations / Standards:** FMVSS 108 / SAE I, S, T, R2

**Volts / Amps:** 12.8 / 1.85A (S) / .22 (T) / 3.06 (BU) (±15%) @ 14V

**Pigtail:** 66863, 66864, 66865

**Bracket:** 93683, 93552, 92510, 93190, 43572, 43655, 43642, 93553, 92512, 43732, 51090, 92513, 92511, 43253

**Grommet:** 91740, 91950

**VMRS Code:** 034-002-059

LED

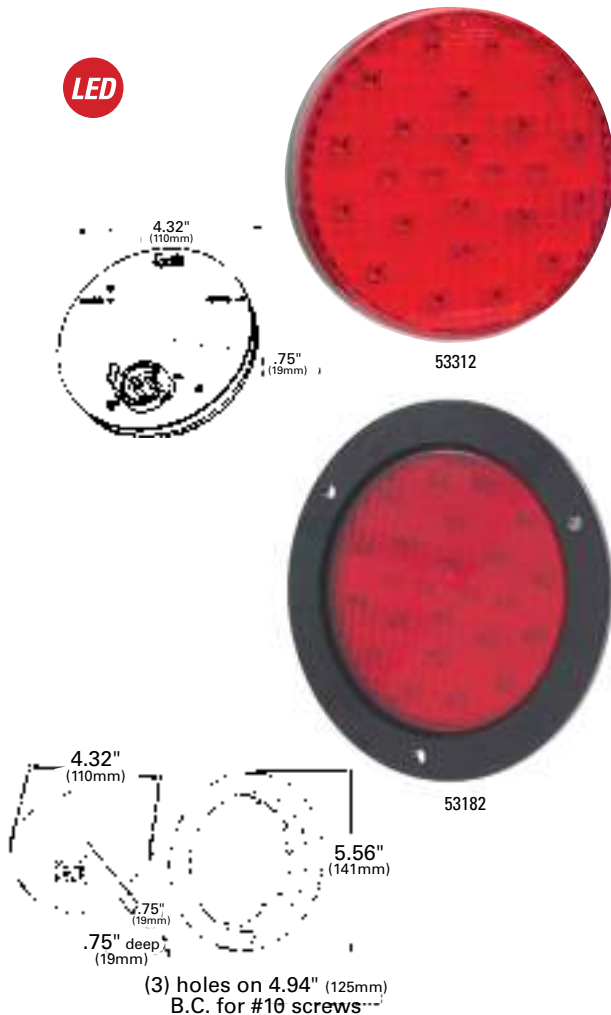

### SUPERNOVA® 4" FULL-PATTERN LED STOP/TAIL/TURN LAMP

• Advanced pin connection system uses tin-plated, solid-brass pin terminations

#### STOP/TAIL/TURN:

- 53312** Red, Grommet Mount, Male Pin  
**52162** Red, Grommet Mount, Male Pin **24 VOLTS**  
**53182** Red, Black Theft-Resistant Flange, Male Pin  
**53192** Red, Stainless Steel Theft-Resistant Flange, Male Pin  
**54562** Red, Grommet Mount, Hard Shell

#### 3 PIN REAR TURN:

- 53413** Yellow, Grommet Mount, Male Pin  
**52163** Yellow, Grommet Mount, Male Pin **24 VOLTS**

#### FRONT PARK/TURN:

- 53313** Yellow, Grommet Mount, Male Pin

#### 2 PIN REAR TURN:

- 55103** Yellow, Grommet Mount, Male Pin

**Material:** Lens - Acrylic; Housing - ABS

**Regulations / Standards:** FMVSS 108 / S/T/T - SAE I, P2, S, T;  
 Rear Turn - SAE I; Front SAE P/T - I, P

**Finish:** Red / Yellow

**Volts / Amps:** Red - 12V / .48A (I,S) / .04A (P2,T),  
 Rear Turn - 12V / .71A (I) / .14A (P2)  
 Front P/T - 12V / 1.06A (I) / .13A (P,P2)  
 Red - 24V / .2A (I,S) / .02A (P2,T)  
 Yellow - 24V / .34A (I) / .06A (P2)

**Bracket:** 93552, 43253, 92510, 92512, 92513, 43572, 43642, 43655, 43732, 93190, 93553, 93683

**Grommet:** 91740, 91950

**Pigtail:** Male Pin: 66815, 67002, 66841, 66816, 67005, 66845  
 Hard Shell: 66861, 66862

**VMRS Code:** 034-002-059



## SUPERNOVA® 4" NEXGEN LED STOP/TAIL/TURN

Uses existing pigtails and wiring for cost-effective retrofit • 20% less current draw than major competitor LED products • Fits all Grote® bracket and grommet mounting options • Similar look to incandescent light which helps prevent theft

### STOP/TAIL/TURN:

|              |  |                  |
|--------------|--|------------------|
| <b>54302</b> | Red, Grommet Mount, Male Pin, Multi Volt   |                  |
| <b>54332</b> | Red, Grommet Mount, Male Pin               |                  |
| <b>54472</b> | Red, Gray Flange, Male Pin                 |                  |
| <b>54482</b> | Red, Black Flange, Male Pin                |                  |
| <b>54492</b> | Red, Stainless Steel Flange, Male Pin      |                  |
| <b>54602</b> | Red, Integrated Flange w/ Gasket, Male Pin | <b>ECE</b>       |
| <b>54362</b> | Red, Grommet Mount, Hard Shell             |                  |
| <b>54292</b> | Red, Grommet Mount, Hard Shell             | <b>MULTI</b>     |
| <b>54573</b> | Red, Integrated Flange, Hard Shell         | <b>MULTI ECE</b> |

### AUXILIARY:

|              |  |
|--------------|--|
| <b>54313</b> | Yellow, Grommet Mount, Front & Rear Turn, Hard Shell |
| <b>54333</b> | Yellow, Grommet Mount, Male Pin                      |
| <b>54493</b> | Yellow, Stainless Steel Flange, Male Pin             |
| <b>54363</b> | Yellow, Grommet Mount, Hard Shell                    |

### 2-PINTURN LAMP:

|              |                                 |
|--------------|---------------------------------|
| <b>54643</b> | Yellow, Grommet Mount, Male Pin |
|--------------|---------------------------------|

**Material:** Lens - Acrylic; Housing - ABS

**Regulations / Standards:** FMVSS 108, ECE Reg7 SI, RI (54602); Reg6 2A (54573) / S/T/T - SAE I, P2, S, T; Auxiliary- SAE P2

**Finish:** Red / Yellow

**Volts / Amps:** 12V / .24A (I,S) / .03A (T)

**Bracket:** 93552, 43253, 92510, 92511, 92512, 92513, 43572, 43642, 43655, 43732, 93190, 93683, 51090

**Grommet:** 91740, 91950

**Pigtail:** Male Pin: 66815, 67002, 66841, 66816, 67005, 66845; Hard Shell: 66861, 66862

**VMRS Code:** 034-002-059



54332

LED



54313

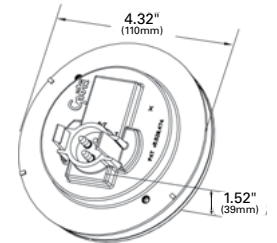

54602

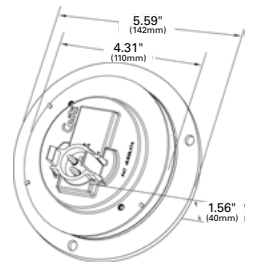

## HI COUNT® 4" LED STOP/TAIL/TURN LAMP

Standard female connection accepts all popular plug-in connectors

• Concentric, high-count diode design: 24 in red, 39 in yellow • Fits all popular mountings and grommets

### STOP/TAIL/TURN:

|                |                         |
|----------------|-------------------------|
| <b>G4002</b>   | Red, PL3                |
| <b>G4002-5</b> | Red, PL3 <b>RETAIL</b>  |
| <b>G4022</b>   | Red, Clear Lens, PL3    |
| <b>G4023</b>   | Yellow, Clear Lens, PL3 |

### STOP/TAIL/TURN KIT:

|              |                             |
|--------------|-----------------------------|
| <b>G4012</b> | Red (G4002 + 91740 + 67090) |
|--------------|-----------------------------|

### AUXILIARY:

|              |             |
|--------------|-------------|
| <b>G4003</b> | Yellow, PL3 |
|--------------|-------------|

**Material:** Lens - Acrylic; Housing - ABS

**Regulations / Standards:** FMVSS 108 / Red - SAE I, P2, S, T; Yellow - Auxiliary

**Finish:** Red / Yellow

**Volts / Amps:** Red - 12V / .48A (I, S) / .04A (P2, T); Yellow - 12V / .71A (I)

**Bracket:** 93552, 43253, 92510, 92511, 92512, 92513, 43572, 43642, 43655, 43732, 93190, 93683, 51090

**Grommet:** 91740, 91950

**Pigtail:** 66825, 67000, 66812, 66844, 66843, 66811, 67090

**VMRS Code:** 034-002-059

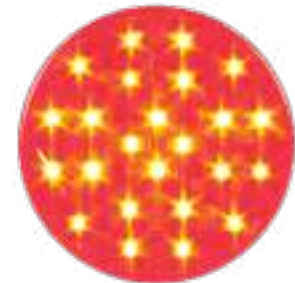

G4002

LED

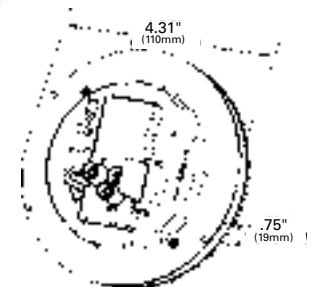

LED

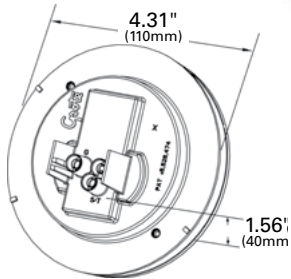

54342

**GROTE SELECT® 4" LED STOP/TAIL/TURN**

Longer life and less current draw than standard incandescent lamps leaves more voltage available to other vehicle systems • Uses existing pigtailed wiring for cost-effective retrofit • Similar look to incandescent light which helps prevent theft

- 54342** Red, Female Pin  
**54342-5** Red, Female Pin **RETAIL**  
**54343** Yellow, Female Pin  
**54282** Red, Female Pin, Grommet Mount **MULTI**

**Material:** Lens - Acrylic; Housing - ABS**Regulations / Standards:** FMVSS 108 / S/T/T- I, SAE P2, S, T; Auxiliary - SAE P2**Finish:** Red / Yellow**Volts / Amps:** 12V / .24A (I, S) / .03A (T)**Bracket:** 93552, 43253, 92510, 92511, 92512, 92513, 43572, 43642, 43655, 43732, 93190, 93553, 93683, 51090**Grommet:** 91740, 91950**Pigtail:** 66825, 67000, 66812, 66844, 66843, 66811, 67090**VMRS Code:** 034-002-059

53102

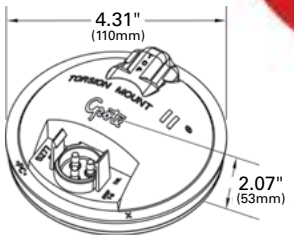
**TORSION MOUNT® II 4" STOP/TAIL/TURN LAMP**

Torsion Mount® II Gel-Mount®, bulb cradle design • Heavy-duty bulb provides greater reliability • O-ring seal and male pin design reduce corrosion • Locking tabs ensure solid pigtail connection

**STOP/TAIL/TURN:**

- 53100** Red, Clear Housing, Male Pin  
**53102** Red, Male Pin  
**52770** Red, Clear Housing, Female Pin  
**52772** Red, Female Pin  
**52152** Red, Female Pin **24 VOLTS**

**STOP/TAIL/TURN KIT:**

- 53112** Red, Male Pin (53102 + 91740 + 67002)  
**52782** Red, Female Pin (52772 + 91740 + 67000)

**FRONT PARK/TURN:**

- 53103** Yellow, Male Pin  
**52773** Yellow, Female Pin

**BUILT-IN REFLECTOR:**

- 52672** Red, Female Pin  
**52682** Red, Female Pin (52672 + 91740 + 67000)

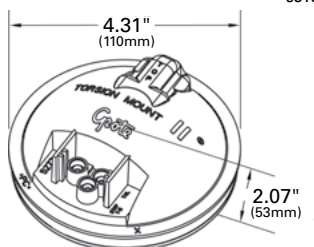

53103

**Material:** Polycarbonate**Regulations / Standards:** FMVSS 108 / SAE I, S, T (52770); Red - SAE I, P2, S, T; Yellow - SAE I, P**Finish:** Red / Yellow**Bulb:** 2057, 32/2 CP**Volts / Amps:** Red: 12V / 2.1A (I, S) / .48A (P2, T)  
Yellow: 12V / 2.1A (I) / .48A (P)**Bracket:** 43572, 43253, 92510, 92512, 92513, 43642, 43655**Grommet:** 91740, 91950**Pigtail:** Male Pin: 66815, 67002, 66841, 66816, 67005, 66845, 66842, 66846;  
Female Pin: 66825, 67000, 66812, 66844, 66843, 66811, 67090, 67014, 67020**VMRS Code:** 034-002-058

### 4" ECONOMY STOP/TAIL/TURN LAMP

Standard female connection • Fits all competitive pigtails, brackets and grommets

**STOP/TAIL/TURN:**

- 52922 Red, Female Pin
- 52922-5 Red, Female Pin RETAIL

**STOP/TAIL/TURN KIT:**

- 53012 Red, Female Pin (52922 + 91740 + 67090)
- 53012-5 Red, Female Pin (52922 + 91740 + 67090) RETAIL

**FRONT PARK/TURN:**

- 52923 Yellow, Female Pin

**Material:** Polycarbonate  
**Regulations / Standards:** FMVSS 108 / Red - SAE I, P2, S, T; Yellow - SAE I, P  
**Finish:** Red / Yellow  
**Bulb:** 2057, 32/2 CP  
**Volts / Amps:** 12V / 2.1A (I, S) / .48A (T, P, P2)  
**Bracket:** 43572, 92510, 92512, 92513  
**Grommet:** 91740, 91950  
**Pigtail:** 66825, 67000, 66812, 66844, 66843, 66811, 67090  
**VMRS Code:** 034-002-058



### GROTE SELECT® LED STOP/TAIL/TURN POWER MODULE WITH SIDEMARKER

Heavy-gauge steel plate and can • Pre-assembled with wiring • Uses Grote Select® 4" LED lamps • Exceeds SAE J914, Nov. '87  
 • Includes reflector

- 51002 Red, Male Pin, RH
- 51012 Red, Male Pin, LH

**Material:** Lens - Acrylic; Housing - Steel; Grommet - PVC  
**Regulations / Standards:** FMVSS 108 / SAE A, I, P2, S, T  
**Finish:** Gray/Red  
**Volts / Amps:** 12V / .24A (I, S) / .06A (P2) / .03A (T)  
**Accessory:** Lamp: S/T/T 53252; Marker: 47092  
**Grommet:** 91740  
**VMRS Code:** 034-002-022



### STOP/TAIL/TURN 4" LAMP POWER MODULE

Heavy-gauge steel plate and can • Torsion Mount® II 4" round sealed lamps  
 • Right or left hand application • Includes reflector

- 51052 Red

**Material:** Material: Lens - Polycarbonate; Housing - Steel; Grommet - PVC  
**Regulations / Standards:** FMVSS 108 / SAE A, I, P2, S, T  
**Finish:** Gray / Red  
**Bulb:** 2057, 32/2 CP  
**Volts / Amps:** 12V / 2.1A (I) / 2.1A (S) / .48A (P2) / .48A (T)  
**Accessory:** Lamp: S/T/T - Red: 52922  
**Bracket:** 51090  
**Grommet:** 91740  
**VMRS Code:** 034-002-022



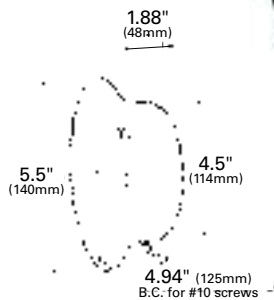
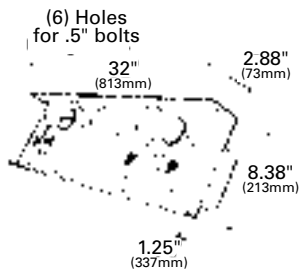
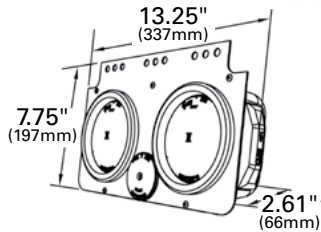

## STOP/TAIL/TURN 4" LAMP POWER MODULE WITH SIDEMARKER

Heavy-gauge steel plate and can • Includes reflector

**51022** Red, RH

**51032** Red, LH

**Material:** Lens - Polycarbonate; Housing - Steel; Grommet - PVC

**Regulations / Standards:** FMVSS 108 / SAE A, I, P2, S, T

**Finish:** Gray

**Volts / Amps:** Bulb 2057, 32/2 CP: 12V / 2.1A (I,S) / .48A (P2,T)  
Bulb 193 (2), 2 CP: 12V / .54A (P2)

**Accessory:** Lamps: S/T/T 52922; Marker: 46742

**Grommet:** 91740

**VMRS Code:** 034-002-022

## POWER UNIT MODULE

Heavy-gauge steel plate and can • Torsion Mount® II 4" round female pin S/T/T lamps • Pre-assembled wiring harness and 5-way connector  
• Includes reflector

**50820** Female Pin Lamps

**Material:** Lens - Polycarbonate ; Housing - Stainless Steel

**Regulations / Standards:** FMVSS 108 / SAE A, I, L, R, S, T

**Finish:** Black

**Volts / Amps:** Bulb 2057 (2), 32/2 CP: 12V - 4.2A (I,S) / .96A (P2,T)  
Bulb 2057, 32/2 CP: 12V / 2.1A (R)  
Bulb 193 (2), 2 CP: 12V / .66A (L)

**Accessory:** Lamp: S/T/T - Female Pin 52772; Back-up - Female Pin 62271;  
License - 62271; License Bracket 43780; Reflector - 40092;  
Grommet: 91740

**VMRS Code:** 034-002-022

## PLASTIC HOUSING LAMP

Snap-ring lens application • 2-wire pigtail

**DOUBLE CONTACT:**

**50222** Red

**Material:** Lens - Acrylic; Housing - Polypropylene

**Regulations / Standards:** FMVSS 108 / SAE I, P2, P3, S, T

**Finish:** Red / Black

**Bulb:** 1157, 32/3 CP

**Volts / Amps:** 12V / 2.1A (I,S) / .59A (P2,P3,T)

**Accessory:** Snap Ring 99593

**Pigtail:** 68130

**Lens:** Red 90012

**VMRS Code:** 034-002-058



## RUBBER HOUSING LAMP

Lens held in by rubber flange • Standard exterior wiring • Brass eyelets in two mounting holes

**DOUBLE CONTACT:**

**50502** Red

**Material:** Lens - Acrylic; Housing - Rubber

**Regulations / Standards:** FMVSS 108 / SAE I, P2, P3, S, T

**Finish:** Red / Black

**Bulb:** 1157, 32/3 CP

**Volts / Amps:** 12V / 2.1A (I, S) / .59A (P2, P3, T)

**Pigtail:** 68150

**Lens:** Red 90012

**VMRS Code:** 034-002-058

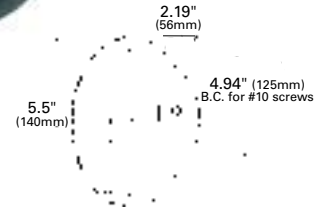

## ECONOMY STAINLESS STEEL HOUSING LAMP

Easy snap-on lens • Rugged stainless steel construction

**DOUBLE CONTACT:**

**52522** Red

**Material:** Lens - Polycarbonate; Housing - Stainless Steel

**Regulations / Standards:** FMVSS 108 / SAE I, P2, P3, S, T

**Finish:** Red / Stainless

**Bulb:** 1157, 32/3 CP

**Volts / Amps:** 12V / 2.1A (I, S) / .59A (P2, P3, T)

**Pigtail:** 68150

**Lens:** Red 90762

**VMRS Code:** 034-002-058

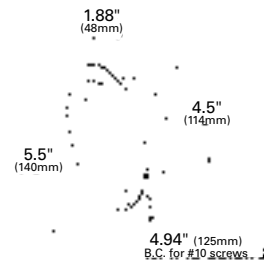

## ECONOMY STEEL HOUSING LAMP

Easy snap-on lens • Rugged steel construction

**DOUBLE CONTACT:**

**50232** Red

**50232-5** Red **RETAIL**

**Material:** Lens - Acrylic; Housing - Steel

**Regulations / Standards:** FMVSS 108 / Double - SAE I, P2, P3, S, T;

Single - SAE I, S

**Finish:** Red / Black

**Volts / Amps:** Bulb 1156, 32 CP: 12 V - 2.1(I, S) / .59A(T)

Bulb 1157, 32/3 CP: 12V / 2.1A (I, S) / .59A (P2, P3, T)

**Accessory:** Snap Ring 99595

**Pigtail:** 68130, 68150

**Lens:** Red 90012

**VMRS Code:** 034-002-058

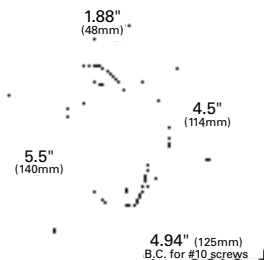



LED

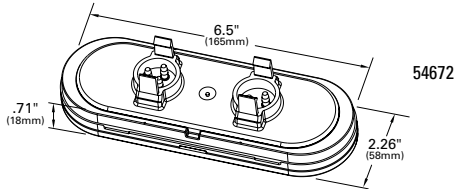

54672

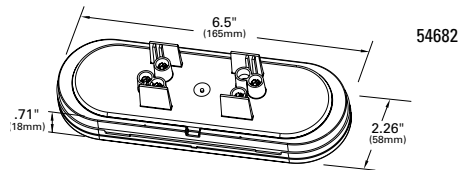

54682

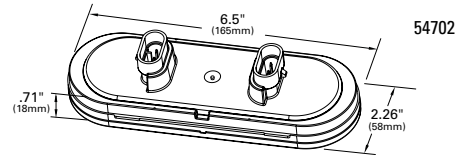

54702

### OVAL LED STOP/TAIL/TURN WITH INTEGRATED BACK-UP LAMP

Innovative patented design combines all stop/tail/turn and back-up functions into one industry standard size lamp • Symmetrical design meets legal requirements at any mounting angle • LED technology provides less maintenance costs and long life • Industry-standard design fits existing mounting grommets, brackets, and flanges • Reduces inventory, SKUs, and carrying costs • Patented design

- 54672** Red, Male Pin  
**54682** Red, Female Pin  
**54702** Red, Hard Shell

**Material:** Red High-Impact Acrylic, Clear Polycarbonate

**Regulations / Standards:** FMVSS 108 / SAE I, S, T, R2

**Volts / Amps:** 12V / 0.13A (I, S), 0.17A (T), 0.16A (R)

**Pigtail:** 66863, 66864, 66865

**Bracket:** 93683, 93552, 92510, 93190, 43572, 43655, 43642, 93553, 92512, 43732, 51090, 92513, 92511, 43253

**Grommet:** 91740, 91950

**VMRS Code:** 034-002-059

LED

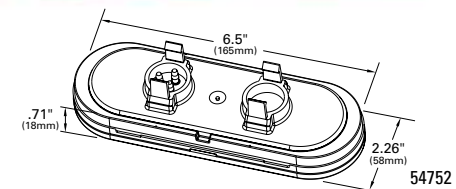

54752

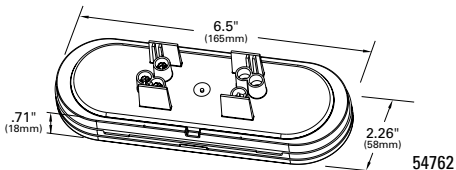

54762

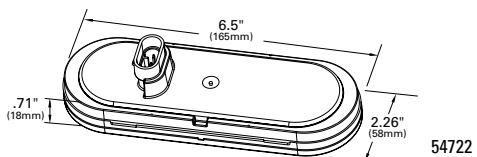

54722

### OVAL LED STOP/TAIL/TURN WITHOUT INTEGRATED BACK-UP LAMP

Thin profile design minimizes chance of external impact damage • Industry-standard design fits existing mounting grommets, brackets, and flanges • Symmetrical design meets legal requirements at any mounting angle

- 54722** Red, Hard Shell  
**54752** Red, Male Pin  
**54762** Red, Female Pin

**Material:** Red High-Impact Acrylic

**Regulations / Standards:** FMVSS 108 / SAE I, S, T

**Voltage Amp:** 12V / 0.13A (I, S), 0.17A (T)

**Pigtail:** 66863, 66864, 66865

**Bracket:** 93683, 93552, 92510, 93190, 43572, 43655, 43642, 93553, 92512, 43732, 51090, 92513, 92511, 43253

**Grommet:** 91740, 91950

**VMRS Code:** 034-002-059

## SUPERNOVA® OVAL LED STOP/TAIL/TURN LAMP

Male pin connection for maximum moisture and corrosion protection  
 • Meets specifications for vertical and horizontal mounting

### STOP/TAIL/TURN:

- 53962** Red, Grommet Mount, Male Pin
- 53592** Red, Gray Theft-Resistant Flange, Male Pin
- 53622** Red, Black Theft-Resistant Flange, Male Pin
- 53972** Red, Stainless Steel Theft-Resistant Flange, Male Pin
- 52072** Red, Grommet Mount, Male Pin **24 VOLT**
- 54802** Red, Clear Lens, Grommet Mount, Hard Wired

### STOP/TAIL/TURN KIT:

- 53122** Red (53962 + 92420 + 67005)

### AUXILIARY:

- 53963** Yellow, Grommet Mount, Male Pin
- 53593** Yellow, Gray Theft-Resistant Flange, Male Pin
- 53973** Yellow, Stainless Steel Theft-Resistant Flange, Male Pin
- 52073** Yellow, Grommet Mount, Male Pin **24 VOLT**

### AUXILIARY KITS:

- 53123** Yellow (53963 + 92420 + 67005)

**Material:** Lens - Acrylic; Housing - ABS  
**Regulations / Standards:** FMVSS 108 / Red - SAE I, P2, S, T; Yellow - SAE P2  
**Finish:** Red / Yellow  
**Volts / Amps:** Red: 12V / .48A (I, S) / .06A (T), 24V / .48A (I, S) / .06A (T)  
 Yellow: 12V / .48A, 24V / .48A  
**Bracket:** 43362, 43952, 43220, 43223, 43222, 43100, 43723, 42152, 42153, 43172  
**Grommet:** 92420, 92720  
**Pigtail:** Male Pin: 66815, 67002, 66841, 66816, 67005, 66845  
 Male Pin 2-Wire: 66842, 67013, 66846, 67016  
**VMRS Code:** 034-002-059



53962

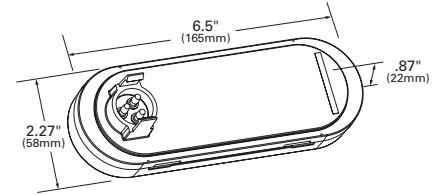

53973

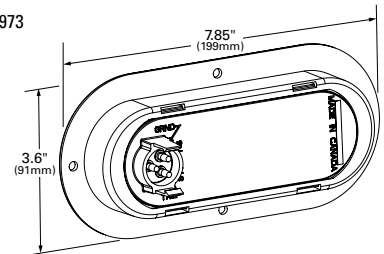

## SUPERNOVA® OVAL LED STOP/TAIL/TURN LAMP

Available in male pin, hard shell, and hardwired connection options for easy retrofit or replacement  
 • Fits current mounting flanges and grommets

- 54132** Red, Male Pin
- 54133** Yellow, Male Pin
- 54142** Red, Hard Shell
- 54143** Yellow, Hard Shell
- 54792** Red, Hardwire

**Material:** Lens - Acrylic; Housing - ABS  
**Regulations / Standards:** FMVSS 108 / SAE I6, P, S, T, P2  
**Finish:** Red/Yellow  
**Volts / Amps:** 13.5V / .02A (T) / .14A (I, S)  
**Accessory:** Chrome Bezel 42153  
**Bracket:** 43362, 43952, 43220, 43223, 43222, 43100, 43723, 42152, 42153, 43132  
**Grommet:** 92420, 92720  
**Pigtail:** Male Pin: 66815, 67002, 66841, 66816, 67005, 66845  
 Hard Shell: 66861, 66862  
**VMRS Code:** 034-002-059

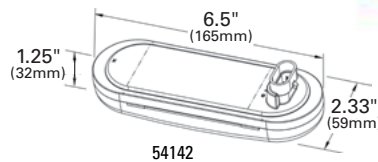

54142

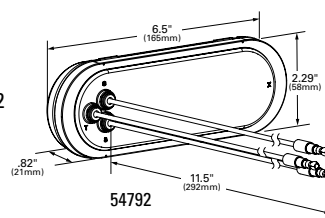

54792

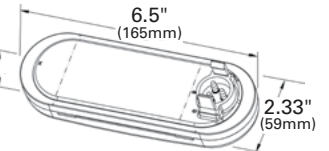

54133

LED



54162

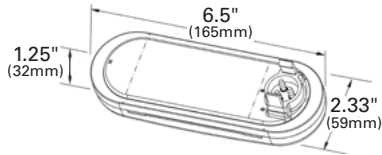

### SUPERNOVA® NEXGEN OVAL LED STOP/TAIL/TURN LAMP

Available in male pin and hardwire for retrofit or replacement

- Fits current mounting flanges and grommets

#### STOP/TAIL/TURN:

**54162** Red, Male Pin

#### AUXILIARY:

**54163** Yellow, Male Pin

**Material:** Lens - Acrylic; Housing - ABS

**Regulations / Standards:** FMVSS 108 / SAE I6, P, S, T, P2

**Finish:** Red/Yellow

**Volts / Amps:** 13.5V / .02A (T) / .14A (I, S)

**Bracket:** 43362, 43952, 43220, 43223, 43222, 43100, 43723, 42152, 42153

**Grommet:** 92420, 92720

**Pigtail:** 66815, 67002, 66841, 66816, 67005, 66845

**VMRS Code:** 034-002-059

LED



G6002

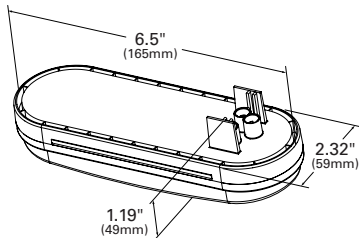

### HI COUNT® OVAL LED STOP/TAIL/TURN LAMP

Female pin connection accepts all popular plug-in connectors • Fits same connections as female incandescent lamps • LEDs provide faster stop warning for trailing vehicles

**G6002** Red, 36 Diodes, PL3

**G6002-5** Red, 36 Diodes, PL3

**G6003** Yellow, 48 Diodes, PL3

**G6012** Red, Clear Lens, 36 Diodes, PL3

**G6013** Yellow, Clear Lens, 48 Diodes, PL3

**Material:** Polycarbonate

**Regulations / Standards:** FMVSS 108 / SAE I, S, T, P, P2

**Finish:** Red / Yellow

**Volts / Amps:** Red - 14V / .33A (I, S) / .015A (T)  
Yellow - 14V / 36A (T) / .03A (P)

**Bracket:** 43362, 43952, 43220, 43223, 43222, 43100, 43723, 42152, 42153, 43173

**Grommet:** 92420, 92720

**Pigtail:** 67090, 67000, 66812, 66811, 66825, 66843, 66844

**VMRS Code:** 034-002-059

RETAIL

LED



54172

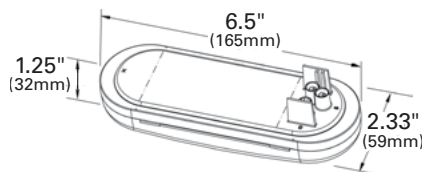

### GROTE SELECT® OVAL LED STOP/TAIL/TURN LAMP

Fits current mounting flanges and grommets • Female pin connection accepts all popular connectors

#### STOP/TAIL/TURN:

**54172** Red

#### AUXILIARY:

**54173** Yellow

**Material:** Lens - Acrylic; Housing - ABS

**Regulations / Standards:** FMVSS 108 / SAE I6, P, S, T, P2

**Finish:** Red/Yellow

**Volts / Amps:** Red 12V / .48A (I, S) / .04A (P2, T); Yellow 12V / .71A (I)

**Bracket:** 43362, 43952, 43220, 43223, 43222, 43100, 43723, 42152, 42153, 43173

**Grommet:** 92420, 92720

**Pigtail:** 66825, 67000, 66812, 66844, 66843, 66811, 67090

**VMRS Code:** 034-002-059

### OVAL LED STOP/TAIL/TURN LAMP

Mounted vertical, horizontal, or 45° degrees • Impact-resistant

**52592-5** Chrome Trim Ring, Red

**Material:** Polycarbonate

**Regulations / Standards:** FMVSS 108 / SAE I, S, T

**Color:** Red

**Voltage Amp:** 12V / .22A (I, S) / .04A (T)

**VMRS Code:** 034-002-059



LED

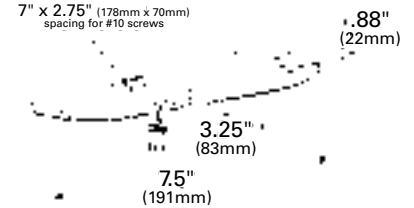

### TORSION MOUNT® III OVAL STOP/TAIL/TURN LAMP

Torsion Mount® III, Gel-Mount® bulb cradle design minimizes bulb vibration  
 • Locking tabs ensure solid pigtail connection

**STOP/TAIL/TURN:**

**52562** Red, Male Pin

**52892** Red, Female Pin

**STOP/TAIL/TURN KIT:**

**52572** Red, Female Pin (52892 + 92420 + 67000)

**FRONT PARK/TURN:**

**52563** Yellow, Male Pin

**52893** Yellow, Female Pin

**Material:** Lens and Housing - Polycarbonate; Grommet - PVC (Kits)

**Regulations / Standards:** FMVSS 108 / Red - SAE I, P2, S, T; Yellow - SAE I, P

**Finish:** Red / Yellow

**Bulb:** 1157, 32/3 CP

**Volts / Amps:** 12V / 2.1A (I, S) / .59A (P, P2, T)

**Bracket:** 43362, 43952, 43220, 43223, 43222, 43100, 43723, 42152, 42153

**Grommet:** 92420, 92720

**Pigtail:** Male Pin: 66815, 66841, 66816, 67005, 66845, 67013, 67016, 66847, 66846  
 Female Pin: 66825, 67000, 66812, 67090

**VMRS Code:** 034-002-058



52562

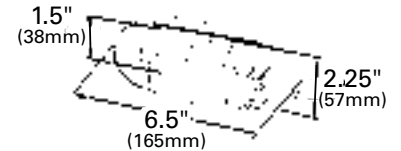

53563

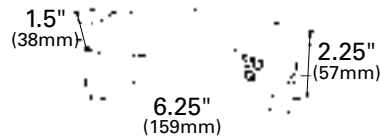

52892





52182

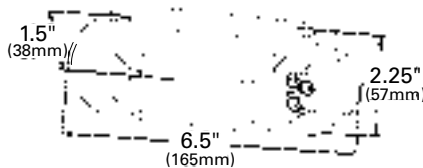

## ECONOMY OVAL STOP/TAIL/TURN LAMP

Female pin connection • Available in both red and yellow

### STOP/TAIL/TURN:

**52182** Red

**52182-5** Red **RETAIL**

### STOP/TAIL/TURN KIT:

**53092** Red (52182 + 92420 + 67090)

### FRONT PARK/TURN:

**52183** Yellow

### FRONT PARK/TURN KIT:

**53093** Yellow (52183 + 92420 + 67090)

**Material:** Polycarbonate

**Regulations / Standards:** FMVSS 108 / Red - SAE I, P2, S, T; Yellow - SAE I, P

**Finish:** Red / Yellow

**Bulb:** 1157, 32/3 CP

**Volts / Amps:** 12V / 2.1A (I, S) / .59A (P, P2, T)

**Bracket:** 43362, 43952, 43220, 43223, 43222, 43100, 43723, 42152, 42153,

**Grommet:** 92420, 92720

**Pigtail:** 66825, 67000, 66812, 67090

**VMRS Code:** 034-002-058

LED

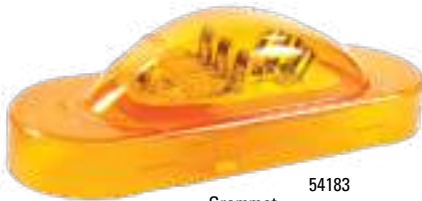

54183

Grommet  
Mount

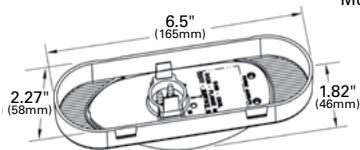

## SUPERNOVA® OVAL LED SIDE TURN/MARKER LAMP

Flashing turn signal is visible to driver during operation • Available in recessed grommet/flange, surface, and integrated flange mount versions

• Male pin and hard shell connection options • 50-state legal, meets SAE J914™ E/E2 and California Title 13

### GROMMET MOUNT:

**54183** Yellow, Male Pin

**54193** Yellow, Hard Shell

**54253** Yellow, Male Pin, w/ Black Theft-Resistant Flange

**54263** Yellow, Male Pin, w/ Stainless Steel Theft-Resistant Flange

**54243** Yellow, Male Pin, w/ Gray Theft-Resistant Flange

### INTEGRATED FLANGE MOUNT:

**54203** Yellow, Male Pin

**54213** Yellow, Hard Shell

### SURFACE MOUNT:

**54223** Yellow, Male Pin

**54233** Yellow, Hard Shell

**Material:** Polycarbonate

**Regulations / Standards:** FMVSS 108 / Optic - SAE E, E2, P2

**Finish:** Yellow

**Volts / Amps:** 13.5V / .45A / .06A

**Bracket:** 43362, 43952, 43220, 43223, 43222, 43100, 43723, 42152, 42153, 43172

**Grommet:** 92420, 92720

**Pigtail:** Male Pin: Male Pin: 66815, 67002, 66841, 66816, 67005, 66845

Hard Shell: 66861, 66862

**VMRS Code:** 034-003-097



Integrated Flange

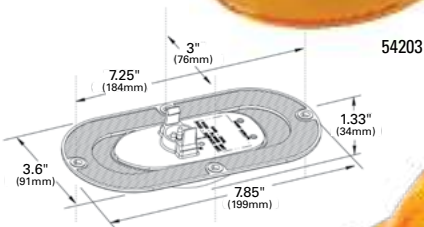

54203



Surface  
Mount

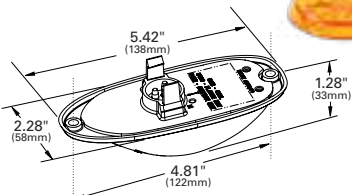

54233



### LED HYBRID SIDE TURN/MARKER LAMP

Hybrid LED/incandescent technology provides a low cost-to-life ratio with an incandescent flashing function and an LED marker

- Vent filters in housing expel water vapor when lamp is lit to prevent water pooling inside lamp
- Foam gasket provides protection against moisture intrusion
- Sealed Packard® style connector minimizes potential failure points associated with conventional pigtail connections
- Used on Navistar® vehicles

**52423** Yellow

**Material:** Polycarbonate  
**Regulations / Standards:** FMVSS 108 / SAE E, E2, P2  
**Finish:** Yellow  
**LED:** Volts / Amps: 12V / .06A (P2)  
**Bulb:** 3156, 32 CP; Volts / Amps: 12V / 2.1A (E, E2)  
**Pigtail:** 66826  
**VMRS Code:** 034-003-097

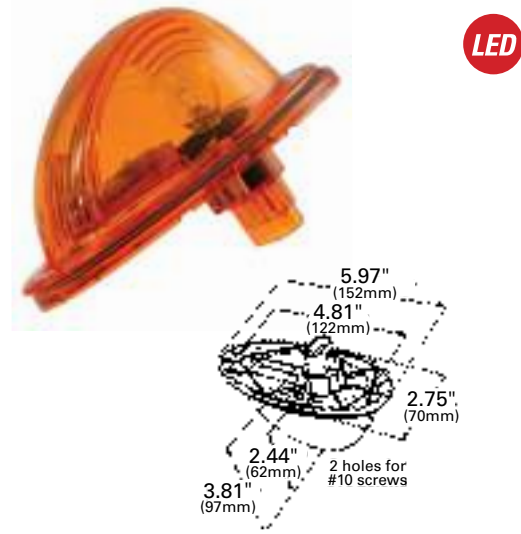

### TORSION MOUNT™ III OVAL SIDE TURN/MARKER LAMP

Torsion Mount® III, Gel-Mount® bulb cradle design minimizes bulb vibration

- Extended dome for added visibility from front and rear
- Fits standard oval lamp grommets and brackets
- Contains reflex reflector
- Exceeds SAE J914™, Nov. '87

**SIDE TURN/MARKER:**

**52533** Yellow, Male Pin  
**52513** Yellow, Female Pin

**Material:** Polycarbonate  
**Regulations / Standards:** FMVSS 108 / SAE A, E, P2, P3  
**Finish:** Yellow  
**Bulb:** 1157, 32/3 CP  
**Volts / Amps:** 12V / 2.1A (E) / .59A (P2, P3)  
**Bracket:** 43362, 43952, 43220, 43223, 43222, 43100, 43723, 42152, 42153  
**Grommet:** 92420, 92720  
**Pigtail:** Male Pin: 66815, 67002, 66841, 66816, 67005, 66845  
**Female Pin:** 66825, 67000, 66812, 66844, 66843, 66811, 67090  
**VMRS Code:** 034-003-097

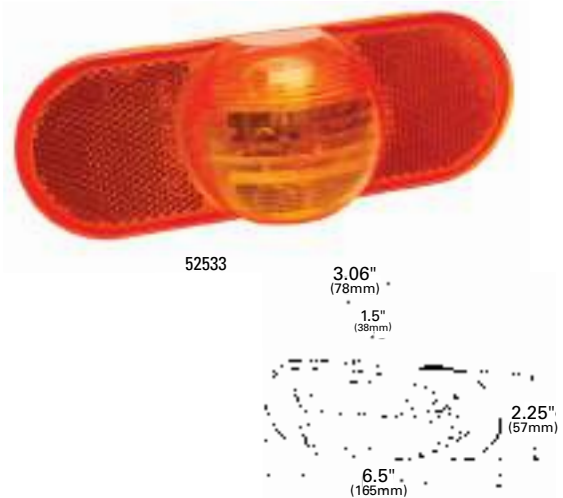

### ECONOMY OVAL SIDE TURN/MARKER LAMP

Standard female pin connection

**52193** Yellow

**KITS:**

**52253** Yellow (52193 + 92420 + 67090)

**Material:** Polycarbonate  
**Regulations / Standards:** FMVSS 108 / SAE A, E, P2  
**Finish:** Yellow  
**Bulb:** 2057, 32/2 CP  
**Volts / Amps:** 12V / 2.1A (E) / .48A (P2)  
**Bracket:** 43362, 43952, 43220, 43223, 43222, 43100, 43723, 42152, 42153,  
**Grommet:** 92420, 92720  
**Pigtail:** 66825, 67000, 66844, 66843, 66811, 67090, 67014, 67020  
**VMRS Code:** 034-003-097

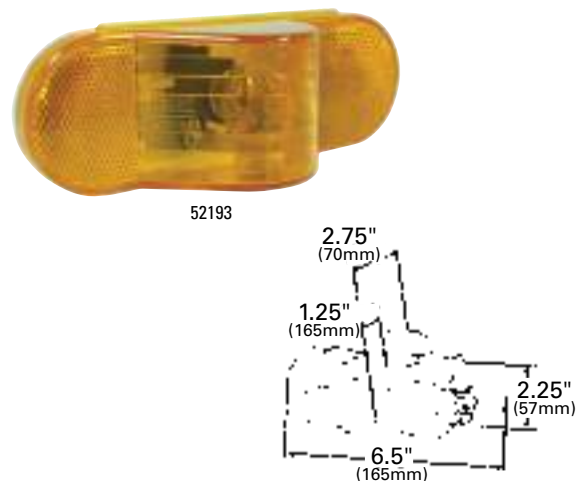



52063

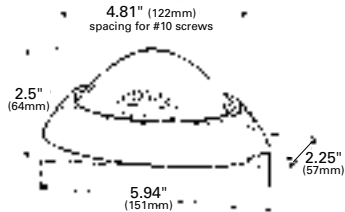

### SMALL AERODYNAMIC COMBINATION MARKER/SIDE TURN LAMP

One-way check valve expels water • High-impact base, polycarbonate lens  
 • Uses reliable 3157, wedge base bulb • Retrofits to Sentry lamp 53063 and 53163 • Great upgrade/replacement on Freightliner® mid-turn lamps  
 • Exceeds SAE J2039™ June '94

#### SIDE TURN/MARKER:

**52023** Yellow, Black Base  
**52063** Yellow, White Base

**Material:** Polycarbonate  
**Regulations / Standards:** FMVSS 108 / SAE E, P2  
**Finish:** Yellow  
**Bulb:** 3157, 32/2 CP  
**Volts / Amps:** 12V / 2.1A (E) / .59A (P2, P3, PC)  
**Pigtail:** 66905, 66904, 66900  
**Lens:** 92893  
**VMRS Code:** 034-003-097



53163

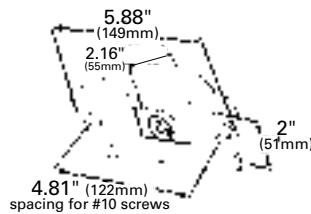

### SENTRY SEALED COMBINATION MARKER/ SIDE TURN LAMP

High-impact base • Uses male pin connection; accepts UBS pigtail  
 • Not recommended for rear of vehicles in padded dock applications  
 • Yellow exceeds SAE J914™ Nov. '87

#### SIDE MARKER:

**53062** Red, White Base

#### SIDE TURN/MARKER:

**53063** Yellow, White Base

#### SIDE TURN:

**53163** Yellow, Black Base

**Material:** Polycarbonate  
**Regulations / Standards:** FMVSS 108 / SAE P2 (53062); SAE E2, P2 (53063); SAE E2 (53163)  
**Finish:** Red / Yellow  
**Volts / Amps:** Bulb 1141, 21 CP - Single Function, 53163: 12V / 1.34A (E2)  
 Bulb 1016, 21/6 CP - Multi-Function, 53062, 53063: 12V / 1.34A (E2) / .59A (P2)  
**Pigtail:** 53062, 53063: 66905, 66900, 66904 53163: 66902  
**VMRS Code:** 034-003-097

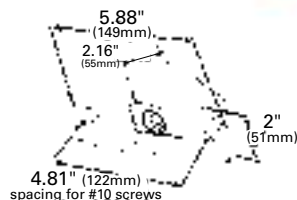

### SENTRY SUPPLEMENTAL HIGH MOUNT STOP LAMP

Application for vehicles over 80" only • High-impact base • Single filament bulb  
 • Not recommended for rear of vehicle in padded dock applications • Must be used in conjunction with a legal CHMSL

**54012** Red

**Material:** Polycarbonate  
**Regulations / Standards:** FMVSS 108 / SAE U  
**Finish:** Red  
**Bulb:** 1141, 21 CP  
**Volts / Amps:** 12V / 1.34A  
**Pigtail:** 66902  
**VMRS Code:** 034-002-040

## FONTAINE® REVOLUTION LED LAMP SYSTEM

LED

Unique and innovative lighting system for Fontaine® trailers

- Stop/tail/turn system utilizes one lamp that can be rotated for left-hand or right-hand installations

**01-5444-75** High Mount Stop/Turn Clearance or ID Lamp  
**01-5445-75** S/T/T Lamp LH/RH

**Material:** Lens - Acrylic; Housing - ABS

**Regulations / Standards:** FMVSS 108 / SAE I, P2, S, T (STT), SAE P2, U (CHMSL)

**Finish:** Red

**Volts / Amps:** 01-5444-75 - 12V / .03A / .21A  
 01-5445-75 - 12V / .127A / .21A / .21A

**VMRS Code:** 034-002-040 - 01-5444-75  
 034-002-059 - 01-5445-75

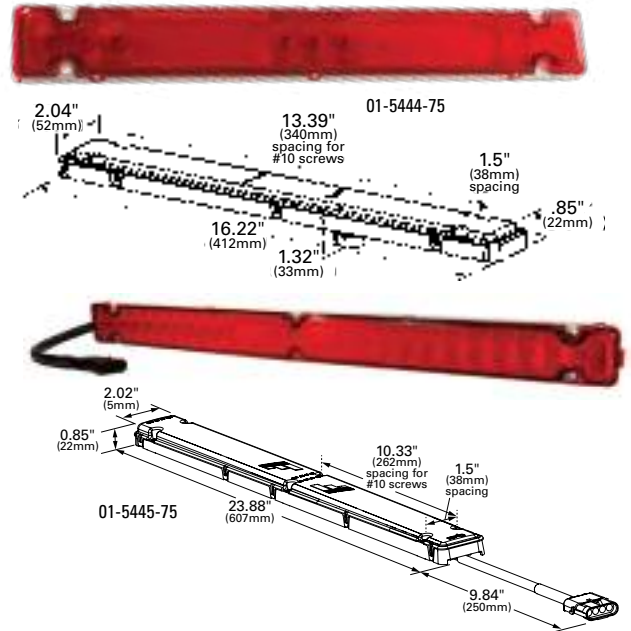

## STOP/TAIL/TURN LED BAR LAMP

LED

- 11-LED configuration
- Can be mounted in vertical, horizontal or 45° angle
- Impact-resistant housing is sealed for moisture protection
- 15" length

**53582** Red

**Material:** Polycarbonate

**Regulations / Standards:** FMVSS 108 / SAE I, S, T

**Finish:** Red

**Voltage Amp:** 12V / .35A (S, I) / .04A (P2, T)

**VMRS Code:** 034-002-059



## SUPERNOVA® TURTLEBACK® II LED HIGH-MOUNT STOP/TURN AND MARKER LAMP

LED

- Lamp functions as a marker, clearance, ID, and supplemental high-mount stop or turn lamp
- Three-wire connection

**54002** Red

**54003** Yellow

**Material:** Polycarbonate

**Regulations / Standards:** FMVSS 108 / SAE P2, U

**Finish:** Red / Yellow

**Volts / Amps:** 12V / .25A (U) / .025A (P2)

**Bracket:** 43050

**Pigtail:** 66815, 67002, 66841, 66816, 67005, 66845

**VMRS Code:** 034-002-040

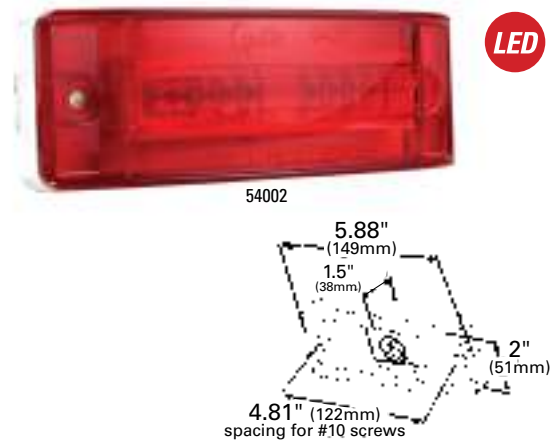

LED

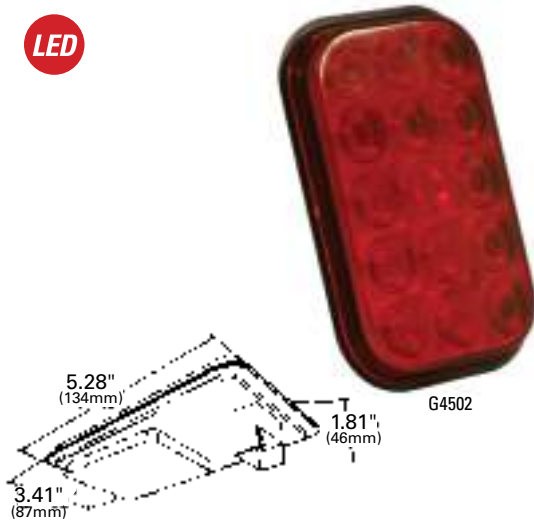

### HI COUNT® RECTANGULAR LED STOP/TAIL/TURN LAMP

Vertical or horizontal mount • Standard female pin connection provides easy retrofits • Yellow lens meets photometric requirements for front park and turn

**G4502** Red  
**G4503** Yellow

**Material:** Polycarbonate  
**Regulations / Standards:** FMVSS 108 / SAE I, P2, S, T  
**Finish:** Red / Yellow  
**Volts / Amps:** Red: 12V / .50A (I, S) / .07 (P2, T)  
Yellow: 12V / .52A (I) / .09A (P)  
**Grommet:** 94180  
**Pigtail:** 66825, 67000, 66812, 66844, 66843, 66811, 67090  
**VMRS Code:** 034-002-059

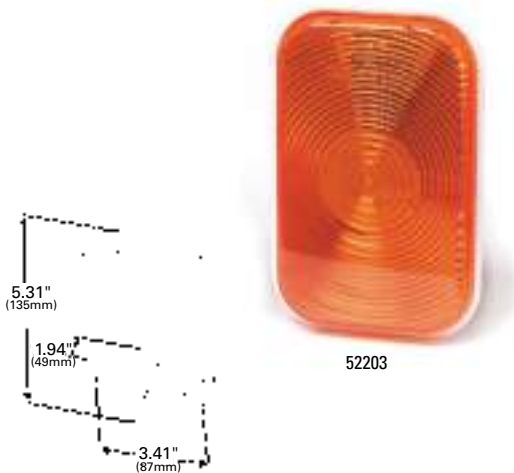

### RECTANGULAR STOP/TAIL/TURN LAMP

Rubber shock-mounted bulb socket • Industry standard female pin connection

**STOP/TAIL/TURN LAMP (DOUBLE CONTACT):**

**52202** Red

**PARK/TURN LAMP (DOUBLE CONTACT):**

**52203** Yellow

**Material:** Polycarbonate  
**Regulations / Standards:** FMVSS 108 / SAE I, P2, S, T (52202); SAE I, P (52203)  
**Finish:** Red / Yellow  
**Bulb:** 2057, 32/2 CP  
**Volts / Amps:** 52202 - 12V / 2.1A (S, I) / .48A (P2, T)  
52203 - 12V / 2.1A (I) / .48A (P)  
**Grommet:** 94180  
**Pigtail:** 66825, 67000, 66812, 66844, 66843, 66811, 67090  
**VMRS Code:** 034-002-058



### RECTANGULAR SURFACE MOUNT TURN LAMP

Double-filament bulb provides park and turn function • Less than 75 sq. cm. lens area • For use on vehicles less than 80" wide

**53132** Red  
**53133** Yellow

**Material:** Steel / Polycarbonate  
**Regulations / Standards:** FMVSS 108 / Red - SAE I, S, T; Yellow - SAE I, P  
**Finish:** Red / Yellow  
**Bulb:** 2057, 32/2 CP  
**Volts / Amps:** 12V / 2.1A (I, S) / .48A (P, T)  
**VMRS Code:** 034-002-058

### SUPERNOVA® THREE-STUD METRI-PACK® LED STOP/TAIL/TURN LAMP

SuperNova® single-LED technology in both the S/T/T and license function

- Replaces GM® 15613944 and 15565732 (53630), 15613943 and 15565731 (53640)
- LED replacement for Navistar® 1661282C91 (53630)
- Includes reflex reflector

**53630** Red, RH  
**53640** Red, LH w/ License Window

**Material:** Polycarbonate  
**Regulations / Standards:** FMVSS 108 / SAE A, I, L, (2)R, S, T  
**Finish:** Red  
**Bulb:** 1156, 32CP (R)  
**Volts / Amps:** 12V / 2.1A (R2) / .35A (I, S) / .16A (L, T)  
**Bracket:** 43842  
**Pigtail:** 68680  
**Lens:** 91302  
**VMRS Code:** 034-002-022 - with License  
 034-002-013 - without License

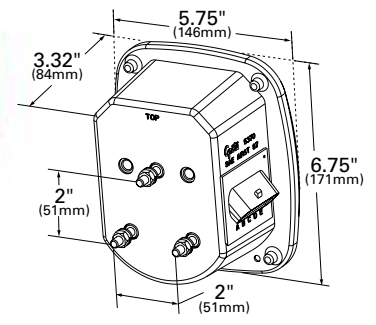

### SUPERNOVA® THREE-STUD METRI-PACK® LED STOP/TAIL/TURN LAMP WITH DOUBLE CONNECTOR

SuperNova® single-LED technology in both the S/T/T and license function

- LED replacement for Navistar® 1661281C91
- Back-up function remains incandescent
- Includes reflex reflector

**53650** Red w/ License Window

**Material:** Polycarbonate  
**Regulations / Standards:** FMVSS 108 / SAE A, I, L, (2)R, S, T  
**Finish:** Red  
**Bulb:** 1156, 32CP (R)  
**Volts / Amps:** 12V / 2.1A (R2) / .35A (I, S) / .16A (L, T)  
**Bracket:** 43842  
**Pigtail:** 68680  
**Lens:** 91302  
**VMRS Code:** 034-002-022

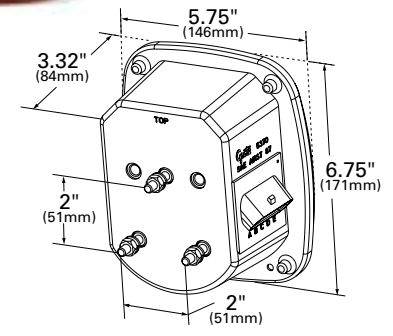

### SUPERNOVA® THREE-STUD LED STOP/TAIL/TURN LAMP

SuperNova® single-LED technology in both the S/T/T and license functions

- Replaces Chevrolet®/GMC® 370867 and 370868
- Replaces Jeep® SF5457197 and SF5457198
- Replaces Peterbilt® 16-02600R and 16-02600L
- Back-up function remains incandescent
- Includes reflex reflector

**50920** Red w/ License Window

**Material:** Polycarbonate  
**Regulations / Standards:** FMVSS 108 / SAE A, I, L, (2)R, S, T  
**Finish:** Red  
**Bulb:** 1156, 32CP (L)  
**Volts / Amps:** 12V / 2.1A (R2) / .35A (I, S) / .16A (L, T)  
**Bracket:** 43842  
**Lens:** 91302  
**VMRS Code:** 034-002-022

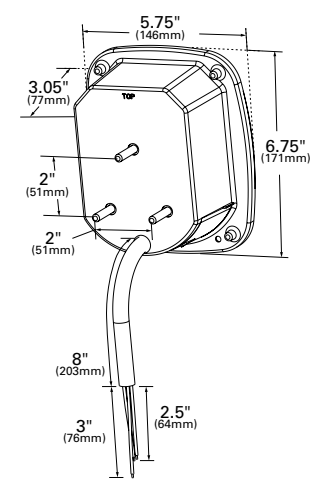



LED

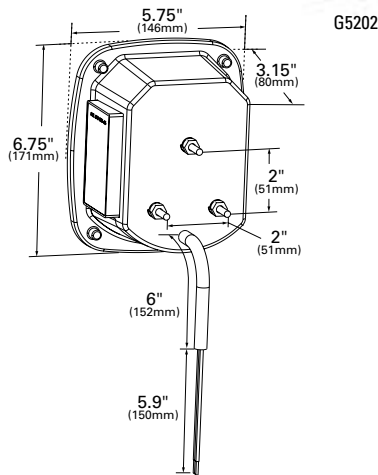

### HI COUNT® LED STOP/TAIL/TURN LAMP

All functions utilize LED technology • Gasket between lens and housing protects against moisture intrusion • Side marker version directly replaces Jeep® Wrangler® lamps through 2006 • Side marker version features circuit board protection that is compatible with the existing flasher technology • 3-stud mounting design incorporates ground function • Mounting hardware and instructions included for easy installation / retrofit • Includes reflex reflector

#### WITH SIDEMARKER:

- G5202** Red, RH w/ Side marker  
**G5212** Red, LH w/ License Window & Side marker

#### WITHOUT SIDEMARKER:

- G5082** Red, RH  
**G5082-5** Red, RH **RETAIL**  
**G5092** Red, LH w/ License Window  
**G5092-5** Red, LH w/ License Window **RETAIL**

**Material:** Lens - Acrylic; Housing - Polycarbonate

**Regulations / Standards:** FMVSS 108 / RH - SAE A, I, (2)R, S, T; LH - SAE A, I, L, R2, S, T

**Finish:** Red

**Volts / Amps:** G5092; 12V / .21A (I, S) / .34A (R2) / .12A (L)  
 G5082; 12V / .21A (I, S) / .34A (R2) / .06A (T)  
 G5212; 12V / 1.4A (I, S) / .34A (R2) / .12A (T, L)  
 G5202; 12V / 1.4A (I, S) / .34A (R2) / .06A (T)

**Bracket:** 43842

**VMRS Code:** 034-002-022 - with License  
 034-002-013 - without License

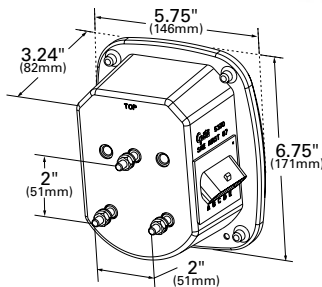

### THREE-STUD METRI-PACK® STOP/TAIL/TURN LAMP

Replaces GM® 15613943 and 15565731 • Features a license window • Metri-Pack® connector on right side • Includes reflex reflector

- 53702** Red, RH w/ License Window  
**53712** Red, LH w/ License Window

**Material:** Lens - Acrylic and Polycarbonate; Housing - Polycarbonate

**Regulations / Standards:** FMVSS 108 / SAE A, I, L, R2, S, T

**Finish:** Red

**Volts / Amps:** Bulb 1156, 32 CP: 12V / 2.1A (R2)  
 Bulb 2057, 32/3 CP: 12V / 2.1A (I, S) / .59A (T, L)

**Bracket:** 43842

**Pigtail:** 68680

**Lens:** Red 91302

**VMRS Code:** 034-002-022

### FORD® STOP/TAIL/TURN BOX LAMP

Junction box with Ford® OEM connector • Features a license window  
 • Ford® driver side: F4HZ 13404 A • Ford® passenger side: F4HZ 13405 A • Includes reflex reflector

- 53782** Red, Right-Hand w/ License Window
- 53792** Red, Left-Hand w/ License Window

**Material:** Polycarbonate / Acrylic  
**Regulations / Standards:** FMVSS 108 / SAE A, I, L, P2, (2)R, S, T  
**Finish:** Red  
**Volts / Amps:** Bulb 3057, 32/3 CP: 12V / 2.1A (I, S, R2) / .59A (T, L, P2)  
**Bracket:** 43842  
**Pigtail:** 01-6868-82  
**Lens:** Red 91302  
**VMRS Code:** 034-002-022

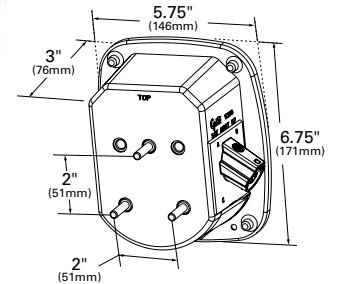

### TWO-STUD METRI-PACK® STOP/TAIL/TURN LAMP WITH SINGLE CONNECTOR

Features a license window • Metri-Pack® connector on left side  
 • Replaces Mack® 14M052M • Includes reflex reflector

- 53722** Red

**Material:** Lens - Acrylic and Polycarbonate; Housing - Polycarbonate  
**Regulations / Standards:** FMVSS 108 / SAE A, I, L, (2)R, S, T  
**Finish:** Red  
**Volts / Amps:** Bulb 1156, 32 CP: 12V / 2.1A (R2)  
 Bulb 1157, 32/3 CP: 12V / 2.1 (I, S) / .59A (T, L)  
**Bracket:** 43262-5, 43022, 43022-5, 43272, 43272-5, 43842  
**Pigtail:** 68680  
**Lens:** Red 91302  
**VMRS Code:** 034-002-022

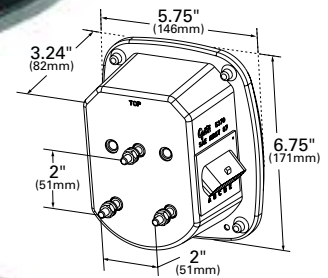

### THREE-STUD METRI-PACK® STOP/TAIL/TURN LAMP WITH DOUBLE CONNECTOR

Features a license window • Metri-Pack® connectors on both sides  
 • Replaces Navistar® 1661281C91 • Includes reflex reflector

- 53762** Red

**Material:** Lens - Acrylic and Polycarbonate; Housing - Polycarbonate  
**Regulations / Standards:** FMVSS 108 / SAE A, I, L, (2)R, S, T  
**Finish:** Red  
**Volts / Amps:** Bulb 1156, 32 CP: 12V / 2.1A (R2)  
 Bulb 1157, 32/3 CP: 12V / 2.1A (I, S) / .59A (T, L)  
**Bracket:** 43842  
**Pigtail:** 68680  
**Lens:** Red 91302  
**VMRS Code:** 034-002-022



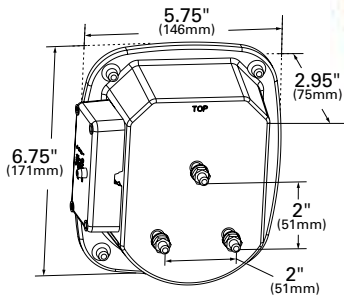

### TORSION MOUNT® UNIVERSAL STOP/TAIL/TURN LAMP

6-in-1 lamp • Four screw posts in junction box • Fits all 3-stud mounting on heavy duty trucks • Includes reflex reflector

**52902** Red, Right-Hand w/ License Window  
**52912** Red, Left-Hand w/ License Window

**Material:** Lens - Acrylic and Polycarbonate; Housing - Polycarbonate

**Regulations / Standards:** FMVSS 108 / SAE A, I, L, (2)R, S, T

**Finish:** Red

**Volts / Amps:** Bulb 1156, 32 CP: 12V / 2.1A (R2)

Bulb 1157, 32/3 CP: 12V / 2.1A (I, S) / .59A (T, L)

**Bracket:** 43842

**Lens:** Red 91302

**VMRS Code:** 034-002-022

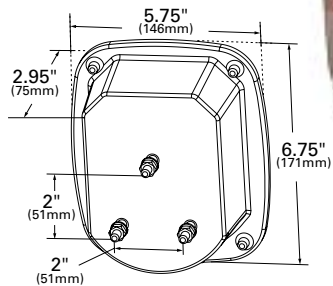

### GROTE® TORSION MOUNT® THREE-STUD GMC® STOP/TAIL/TURN LAMP

Junction box with quick splice or ring connectors • Replaces GMC® 715103 or 2063933 (RH) • Replaces GMC® 715104 or 2063931 (LH) • Includes reflex reflector and wire cover

**50902** Red, Right-Hand w/ License Window  
**50912** Red, Left-Hand w/ License Window

**Material:** Lens - Acrylic and Polycarbonate; Housing - Polycarbonate

**Regulations / Standards:** FMVSS 108 / SAE A, I, L, R2, S, T

**Finish:** Red

**Volts / Amps:** Bulb 1156, 32 CP: 12V / 2.1A (R2)

Bulb 2057, 32/2 CP: 12V / 2.1A (I, S) / .59A (T, L)

**Bracket:** 43842

**Lens:** Red 91302

**VMRS Code:** 034-002-022

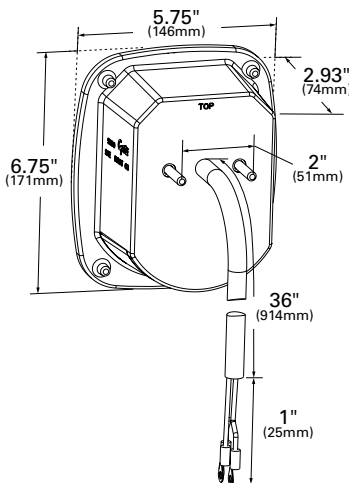

### TORSION MOUNT® TWO-STUD MACK®/ DODGE® STOP/TAIL/TURN LAMP

Fits both right hand and left hand • Includes OE 39" pigtail with ring terminal • Replaces Mack® 14M0444RP1 and 14M0444RP4 shock mount • Features a license window • Includes reflex reflector

**50992** Red

**Material:** Lens - Acrylic and Polycarbonate; Housing - Polycarbonate

**Regulations / Standards:** FMVSS 108 / SAE A, I, L, R2, S, T

**Finish:** Red

**Volts / Amps:** Bulb 1156, 32 CP: 12V / 2.1A (R2)

Bulb 2057, 32/3 CP: 12V / 2.1A (I, S) / .59A (T, L)

**Bracket:** 43262-5, 43022, 43022-5, 43272, 43272-5, 43842

**Lens:** Red 91302

**VMRS Code:** 034-002-022

### THREE-STUD PETERBILT®/CHEVROLET®/JEEP®/GMC® STOP/TAIL/TURN LAMP WITH PIGTAIL

Replaces Peterbilt® 16-02600R and 16-02600L • Replaces Chevrolet®/GMC® 370867 and 370868 • Replaces Jeep® SF5457197 and SF5457198  
• Features license window • Includes reflex reflector

- 50972 Red w/ License Window
- 50972-5 Red w/ License Window **RETAIL**

**Material:** Lens - Acrylic and Polycarbonate; Housing - Polycarbonate  
**Regulations / Standards:** FMVSS 108 / SAE A, I, L, R2, S, T  
**Finish:** Red  
**Volts / Amps:** Bulb 1156, 32 CP: 12V / 2.1A (R2)  
Bulb: 1157, 32/3 CP: 12V / 2.1A (I, S) / .59A (T, L)  
**Bracket:** 43842  
**Lens:** Red 91302  
**VMRS Code:** 034-002-022



### THREE-STUD, CHEVROLET®/FORD®/JEEP® STOP/TAIL/TURN LAMP WITH SIDE MARKER LAMP AND MOLDED PIGTAIL TERMINATION

Round molded terminals • Replaces Chevrolet®/GMC® 477331 and 477332 (RH) • Replaces Jeep® SF5758255 and SF5758254 (LH)  
• Features sidemarkers • Includes reflex reflector

**WITHOUT LICENSE WINDOW:**

- 52802 Red, RH

**WITH LICENSE WINDOW:**

- 52812 Red, LH

**Material:** Lens - Acrylic; Housing - Polycarbonate  
**Regulations / Standards:** FMVSS 108 / RH - SAE A, I, P2, R2, S, T; LH - SAE A, I, L, P2, R2, S, T  
**Finish:** Red  
**Volts / Amps:** Bulb 1156, 32 CP: 12V / 2.1A (R2)  
Bulb 1157, 32/3 CP: 12V / 2.1A (I, S) / .59A (T, L)  
**Bracket:** 43842  
**Lens:** Red 91302  
**VMRS Code:** 034-002-022 - with License  
034-002-013 - without License

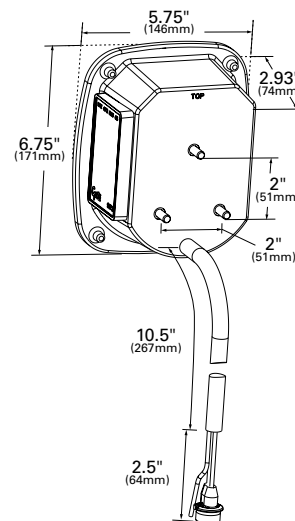



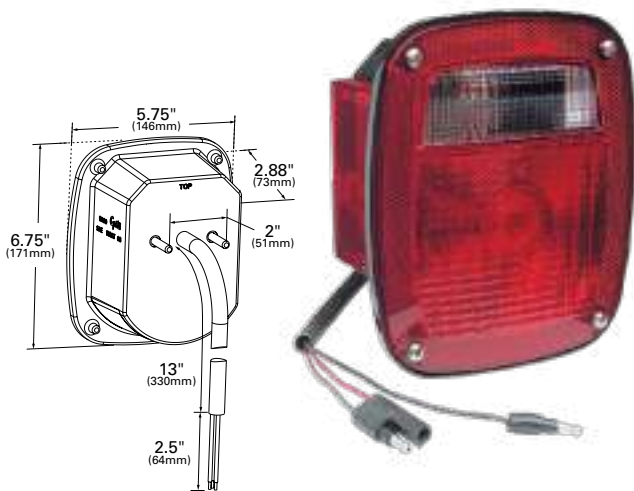

### TORSION MOUNT® TWO-STUD DODGE® STOP/TAIL/TURN LAMP WITH SIDE MARKER LAMP AND MOLDED PIGTAIL TERMINATION

Replaces Dodge® 4114562 (RH) • Replaces Dodge® 4114561 and 4114563 (LH) • Includes reflex reflector

#### WITHOUT LICENSE WINDOW:

**52822** Red, Right-Hand

#### WITH LICENSE WINDOW:

**52832** Red, Left-Hand

**Material:** Lens - Acrylic; Housing - Polycarbonate

**Regulations / Standards:** FMVSS 108 / RH - SAE A, I, P2, R2, S, T; LH - SAE A, I, L, P2, R2, S, T

**Finish:** Red

**Volts / Amps:** Bulb 1156, 32 CP: 12 V / 2.1A (R2)  
Bulb 1157, 32/3 CP: 12 V / 2.1(I, S) / .59A (T, L)  
Bulb 193, 2CP: 12V / .33A(P2)

**Bracket:** 43262-5, 43022, 43022-5, 43272, 43272-5, 43842

**Lens:** Red 91302

**VMRS Code:** 034-002-022 - with License  
034-002-013 - without License

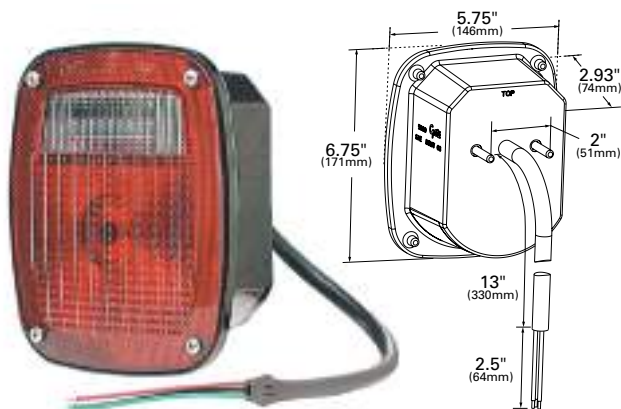

### TORSION MOUNT® TWO-STUD DODGE® STOP/TAIL/TURN LAMP

Standard mount pigtail • Replaces Dodge® truck 3895020 and 3895021  
• Features license window • Includes reflex reflector

**52602** Red

**Material:** Lens - Acrylic and Polycarbonate; Housing - Polycarbonate

**Regulations / Standards:** FMVSS 108 / SAE A, I, L, R2, S, T

**Finish:** Red

**Bulb:** 1156, 32 CP

**Volts / Amps:** Bulb 1156, 32 CP: 12V / 2.1A (R2)  
Bulb 1157, 32/2 CP: 12V / 2.1A (I, S) / .59A (T, L)

**Bracket:** 43262-5, 43022, 43022-5, 43272, 43272-5, 43842

**Lens:** Red 91302

**VMRS Code:** 034-002-022

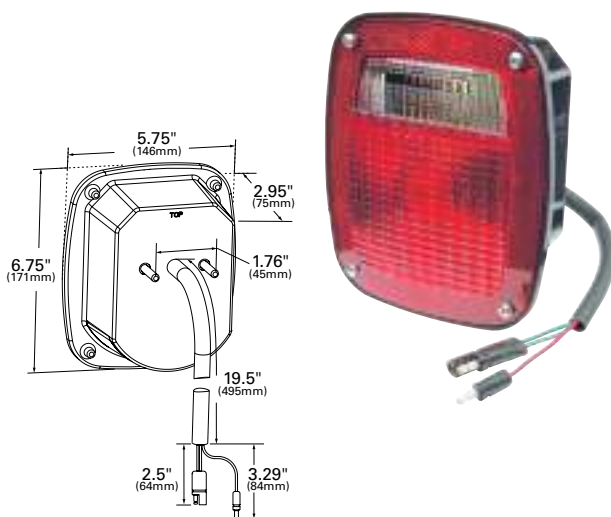

### TWO-STUD FORD® STOP/TAIL/TURN LAMP WITH PIGTAIL AND MOLDED PLUG

Studs on 1 3/4" centers • Retrofits Ford® OEM C7TZ13404C, DOTZ13404A, D3KZ13404A, D3TZ13403B, E2TB13404A, E2TB13405A • Features license window • Includes reflex reflector

**52972** Red

**Material:** Lens - Acrylic and Polycarbonate; Housing - Polycarbonate

**Regulations / Standards:** FMVSS 108 / SAE A, I, L, R2, S, T

**Finish:** Red

**Volts / Amps:** Bulb 1156, 32 CP: 12 V / 2.1A (R2)  
Bulb 2057, 32/2 CP: 12V / 2.1A (I, S) / .59A (T, L)

**Bracket:** 43262-5, 43022, 43022-5, 43272, 43272-5, 43842

**Lens:** Red 91302

**VMRS Code:** 034-002-022



### 4" TWO-STUD STOP/TAIL/TURN LAMP

Snap-on lens • Rubber compression-sealed pigtail • Removable studs for school bus application

**WITH LICENSE WINDOW:**

**50852** Red

**WITHOUT LICENSE WINDOW:**

**50862** Red

**Material:** Lens - Acrylic and Polycarbonate (50832/-5); Housing - Polycarbonate  
Lens - Acrylic and Polycarbonate (50862/-5)

**Regulations / Standards:** FMVSS 108 / SAE I, L, P2, S, T

**Finish:** Red

**Bulb:** 1157, 32/3 CP

**Volts / Amps:** 12V / 2.1A (I, S) / .59A (P2, T, L)

**Bracket:** 43262-5, 43022, 43022-5, 43272, 43272-5, 43842

**Pigtail:** 68150

**Lens:** Red 90232

**VMRS Code:** 034-002-058

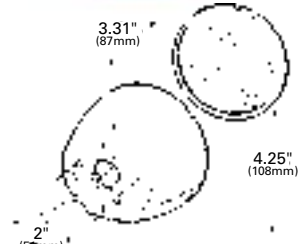

### 4" UNIVERSAL MOUNT STOP/TAIL/TURN LAMP

2-screw lens • Less than 75 sq. cm. of effective, projected luminous lens area • Rubber compression-sealed pigtail • Features license window  
• For use on vehicles less than 80" wide

**WITH LICENSE WINDOW:**

**50872** Red

**Material:** Lens - Acrylic; Housing - Polypropylene

**Regulations / Standards:** FMVSS 108 / SAE I, L, P2, S, T

**Finish:** Red

**Bulb:** 1157, 32/3 CP

**Volts / Amps:** 12V / 2.1A (I, S) / .59A (L, P2, T)

**Bracket:** 43262-5, 43022, 43022-5, 43272, 43272-5, 43842

**Pigtail:** 68150

**Lens:** Red 91482

**VMRS Code:** 034-002-058

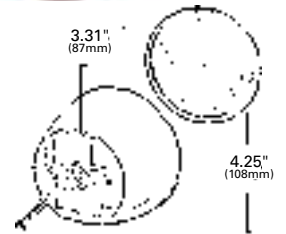

### 4" STEEL TWO-STUD MOUNT STOP/TAIL/TURN LAMP

Less than 75 sq. cm. of effective, projected luminous lens area  
• Heavy-gauge, formed steel body • Rubber compression-sealed pigtail  
• For use on vehicles less than 80" wide

**WITH LICENSE WINDOW:**

**50882** Red

**WITHOUT LICENSE WINDOW:**

**50892** Red

**Material:** Lens - Acrylic; Housing - Steel

**Regulations / Standards:** FMVSS 108 / SAE I, L, P2, S, T (50882);  
SAE I, P2, S, T (50892)

**Finish:** Red

**Bulb:** 1157, 32/3 CP

**Volts / Amps:** 12V / 2.1A (I, S) / .59A (L, P2, T)

**Bracket:** 43262-5, 43022, 43022-5, 43272, 43272-5, 43842

**Pigtail:** 68150

**Lens:** Red 90252

**VMRS Code:** 034-002-058

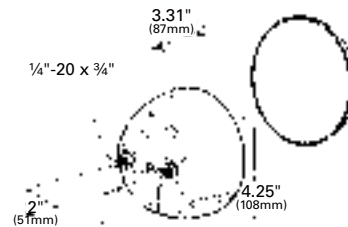

LED

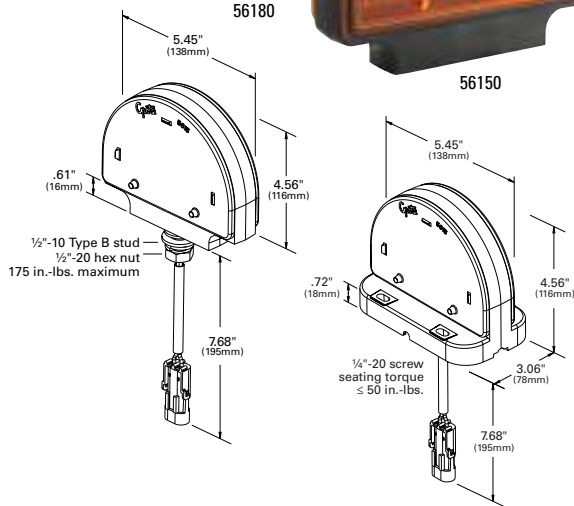

## LED STOP/TAIL/TURN LAMP FOR AGRICULTURE & OFF-HIGHWAY APPLICATIONS

Lamps meet the latest ASABE S279.17 specifications • Lamps may be mounted right side up, upside down, or vertically and still meet compliance specifications • Lamps employ bi-voltage circuitry – 12/24 volt

|              |                                  |              |
|--------------|----------------------------------|--------------|
| <b>56150</b> | Yellow and Yellow, Pedestal      | <b>MULTI</b> |
| <b>56160</b> | Yellow and Yellow, Surface Mount | <b>MULTI</b> |
| <b>56170</b> | Red, Pedestal                    | <b>MULTI</b> |
| <b>56180</b> | Red, Surface Mount               | <b>MULTI</b> |

**Material:** Lens - High Impact Acrylic; Housing - ABS

**Regulations / Standards:** FMVSS 108 / SAE I6 (56150 & 56160); SAE I, S, T (56170 & 56180)

**Other:** IP67 Compliant

**Finish:** Yellow, Red

**Voltage:** Bi-voltage, 12 and 24 Volt  
 Red - 14V / .0142A (T) / .142A (S, T)  
 Red - 28V / .0081A (T) / .075A (S, T)  
 Yellow - 14V / .556A (HAZ)  
 Red - 28V / .0286A (HAZ)

**VMRS Code:** 034-002-059

## HI COUNT® DOUBLE-FACE LED STOP/TAIL/TURN LAMP WITH SIDEMARKER

2-stud mounting bolts • 25 diodes on either front or back with two diodes in the sidemarker • Attached three-wire harness • Includes reflex reflector

|                |   |
|----------------|---|
| <b>G5530</b>   | Red and Yellow, Left-Hand                             |
| <b>G5540</b>   | Red and Yellow, Right-Hand                            |
| <b>G5543-5</b> | Yellow and Yellow, w/ Packard Connector <b>RETAIL</b> |

**Material:** Lens - Acrylic; Housing - Chrome-Plated ABS

**Regulations / Standards:** FMVSS 108 / SAE A, I, T, P, P2 (G5530, G5540); SAE A, I, P, P2 (G5543-5)

**Finish:** Chrome / Red / Yellow

**Volts / Amps:** 12V / .775A (I) / .038A (P, P2, T)

**VMRS Code:** 034-002-059

## TWO-STUD PLUG-IN LAMP WITH SIDE MARKER

Incorporates side marker light • Fits right or left side • Keyed, plug-in receptacle, accepts OEM harness • Standard with Navistar®/Volvo®  
 • Vertical mount • Includes reflex reflector

|              |                |
|--------------|----------------|
| <b>55470</b> | Red and Yellow |
|--------------|----------------|

**Material:** Lens - Acrylic; Housing - Polycarbonate

**Regulations / Standards:** FMVSS 108 / SAE A, I, P2

**Finish:** Red / Yellow

**Volts / Amps:** Bulb 1156, 32 CP: 12V / 2.1A (I)  
 Bulb 193, 2 CP: 12V / .33A (P2)

**Lens:** Red 91502; Yellow 91503; Sidemarker - Yellow 91513

**VMRS Code:** 034-003-057

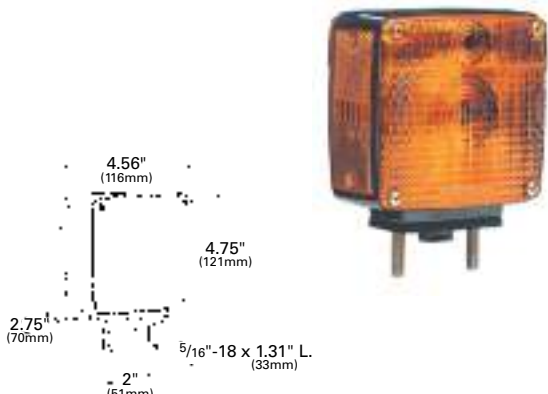
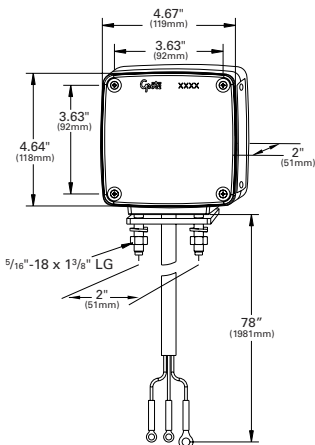

### TWO-STUD CHROME LAMP WITH PIGTAIL

Switch lens for right or left applications • Ground wire plus tab • PVC wire jacket material • 73" color-coded pigtail • Vertical mount • Includes reflex reflector

**55340** Red and Yellow

**Material:** ABS / Acrylic / Polycarbonate  
**Regulations / Standards:** FMVSS 108 / SAE A, I, P2  
**Finish:** Red / Yellow  
**Volts / Amps:** Bulb 1156, 32 CP: 12V / 2.1A (I)  
 Bulb 193, 2 CP: 12V / .33A (P2)  
**Lens:** Red 90482, Yellow 90483  
**VMRS Code:** 034-003-057

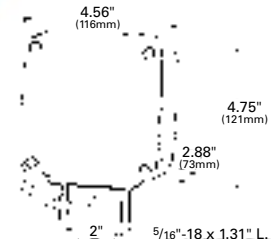

### TWO-STUD LAMP WITH PIGTAIL

High-heat acrylic lens • 2" mounting centers • Incorporates sidemarker light • Replaces Chevrolet®/GMC® 2017747 (RH) and 2017751 (LH) • Includes reflex reflector

**55410** Red and Yellow, Right-Hand  
**55420** Red and Yellow, Left-Hand

**Material:** Lens - Acrylic; Housing - Polycarbonate  
**Regulations / Standards:** FMVSS 108 / SAE A, I, P, P2  
**Finish:** Red / Yellow  
**Volts / Amps:** Bulb 1156, 32 CP: 12V / 2.1A (I)  
 Bulb 193, 2 CP (X2): 12V / .66A (P, P2)  
**Lens:** Red 91502, Yellow 91503; Sidemarker - Yellow 91513  
**VMRS Code:** 034-003-057

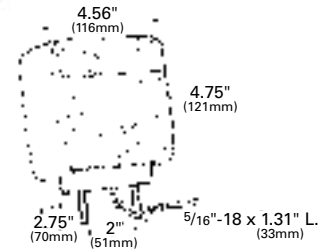

### PEDESTAL-MOUNT LAMP WITH PIGTAIL

High-heat acrylic-lens • Incorporates sidemarker light • Replaces Chevrolet®/GMC® 694628 (RH) • Replaces Chevrolet®/GMC® 694627 (LH) • Includes reflex reflector

**55450** Red and Yellow, Right-Hand  
**55460** Red and Yellow, Left-Hand

**Material:** Lens - Acrylic; Housing - ABS/Polycarbonate  
**Regulations / Standards:** FMVSS 108 / SAE A, I, P, P2  
**Finish:** Red / Yellow  
**Volts / Amps:** Bulb 1156, 32 CP: 12V / 2.1A (I)  
 Bulb 193, 2 CP (X2): 12V / .66A (P, P2)  
**Lens:** Red 91502, Yellow 91503; Sidemarker - Yellow 91513  
**VMRS Code:** 034-003-057

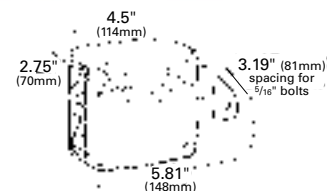

LED

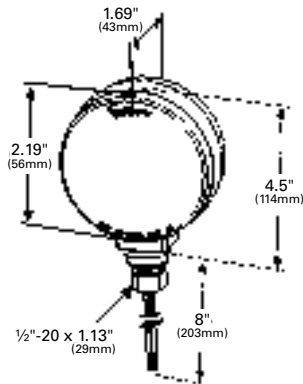

### 4" HI COUNT® DOUBLE-FACE LED LAMP

Attractive multiple diode design • Heavy-duty housing with hardwired connection for variable wiring options • Two-wire, double-contact installation

**G5300** Red and Yellow

**Material:** Lens - Acrylic; Housing - Chrome-Plated Die-cast Zinc

**Regulations / Standards:** FMVSS 108 / SAE I, T

**Finish:** Chrome / Red / Yellow

**Volts / Amps:** 12V / .77A (I) / .038A (T)

**Lens:** Red 92062; Yellow 92063

**VMRS Code:** 034-002-013

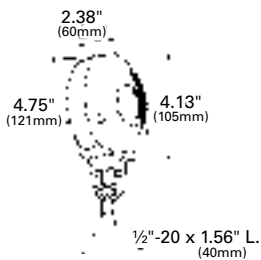

### 4" ZINC DIE-CAST DOUBLE-FACE LAMP

Less than 75 sq. cm. of effective, projected luminous lens area • For use on vehicles less than 80" wide

#### DOUBLE CONTACT:

**53000** Red and Yellow, Chrome-Plated

**53020** Red and Yellow, Black Enamel Finish

**53023** Yellow and Yellow, Black Enamel Finish

#### SINGLE CONTACT:

**56000** Red and Yellow, Chrome-Plated

**56020** Red and Yellow, Black Enamel Finish

**Material:** Lens - Acrylic; Housing - Chrome-Plated Die-cast Zinc

**Regulations / Standards:** FMVSS 108 / SAE Double - SAE I, P; Single - SAE I

**Finish:** Red / Yellow

**Volts / Amps:** Bulb (53000, 53020, 53023) 1157, 32/3 CP: 12V / .59A (P) / 2.1A (I)  
Bulb (56000, 56020) 1156, 32 CP: 12V / 2.1A (I)

**Pigtail:** 68130, 68170

**Lens:** Red 91582; Yellow 91583

**VMRS Code:** 034-002-013

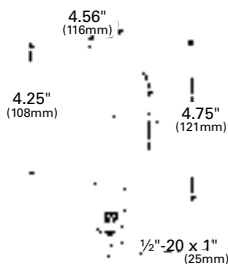

### THIN-LINE ZINC DIE-CAST DOUBLE-FACE LAMP

For fender or front bracket mount • Wire exit has a grommet to protect the jacket from abrasion • Single contact

**55280** Red and Yellow, Baked Aluminum Finish

**55290** Red and Yellow, Chrome-Plated

**Material:** Lens - Polycarbonate; Housing - Die-cast Zinc

**Regulations / Standards:** FMVSS 108 / SAE I

**Finish:** Red / Yellow

**Bulb:** 1156, 32 CP

**Volts / Amps:** 12V / 2.1A

**Pigtail:** 68170

**Lens:** Red 90232, Yellow 90233

**VMRS Code:** 034-002-013

### THIN-LINE DOUBLE-FACE LAMP

Easy snap-on lenses • Molded-in baffle • Molded-in o-ring • Wire exit has a grommet to protect jacket against abrasion

**DOUBLE CONTACT:**

**50630** Red and Yellow

**SINGLE CONTACT:**

**55220** Red and Yellow

**55223** Yellow and Yellow

**Material:** Lens - Acrylic; Housing - Polycarbonate

**Regulations / Standards:** FMVSS 108 / Double - SAE I, P; Single - SAE I

**Finish:** Red / Yellow

**Volts / Amps:** Bulb (50630) 1157, 32/3 CP: 12V / 2.1A (I) / .59A (P)  
Bulb (55220, 55223) 1156, 32 CP: 12V / 2.1A (I)

**Pigtail:** 68170, 68130

**Lens:** Red 90232, Yellow 90233

**VMRS Code:** 034-002-013

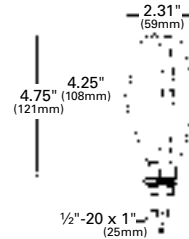

### SINGLE-FACE LAMP

Easy snap-on lens • Molded-on baffle • Rubber plug-in pedestal

**DOUBLE CONTACT:**

**50642** Red

**Material:** Polycarbonate

**Regulations / Standards:** FMVSS 108 / SAE I, S, T

**Finish:** Red

**Bulb:** 1157, 32/3 CP

**Volts / Amps:** 12V / 2.1A (I,S) / .59A (T)

**Pigtail:** 68130, 68170

**Lens:** 90232

**VMRS Code:** 034-002-013

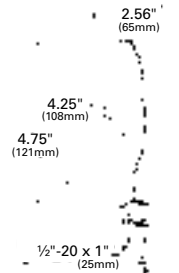

### STEEL SINGLE-FACE LAMP

Snap-ring lens application • Two-wire pigtail • Long-life bulb

**DOUBLE CONTACT:**

**50352** Red

**Material:** Lens - Acrylic; Housing - Steel

**Regulations / Standards:** FMVSS 108 / SAE I, P2, P3, S, T

**Finish:** Red

**Bulb:** 1157, 32/3 CP

**Volts / Amps:** 12V / 2.1A (I,S) / .59A (P2, P3, T)

**Accessory:** Snap Ring 99593

**Pigtail:** 68130

**Lens:** Red 90012

**VMRS Code:** 034-002-013

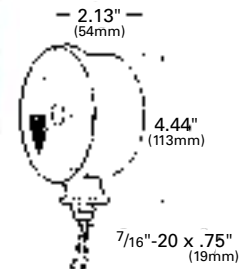



LED

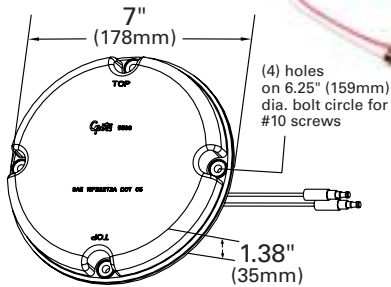

55983

**7" LED STOP/TAIL/TURN LAMP**

UV-protected lens • Male .180 bullet connectors • Surface mount installation (no cut-outs required) • Install using #10 screws

**STOP/TAIL/TURN LAMP**

**53422** Red, Stop/Tail/Turn Lamp w/ Reflex

**SINGLE FUNCTION:**

**55982** Red, Turn Lamp w/ Reflex  
**55983** Yellow, Front Turn Lamp w/ Reflex  
**55992** Red, Turn Lamp w/o Reflex  
**55993** Yellow, Turn Lamp w/o Reflex

**Material:** Polycarbonate

**Regulations / Standards:** FMVSS 108 / SAE A, I, P2, S, T (53422); SAE A, I, S (55982); SAE A, I (55983); SAE I (55982/3)

**Finish:** Red / Yellow

**Volts / Amps:** S/T/T - 12V / .39A (A, I) / .03A (P2, T)  
 Single Function - 12V / .39A (I, S)

**Bracket:** 93982

**VMRS Code:** 034-003-071

LED

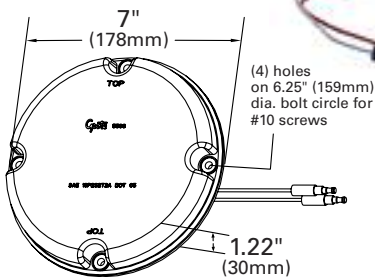
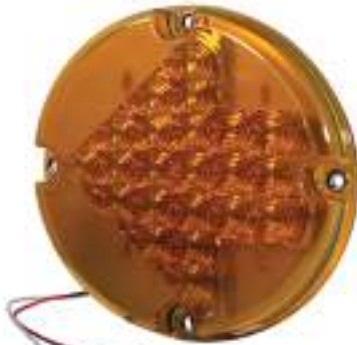
**7" LED ARROW TURN LAMP**

Large arrow pattern makes it easier for road traffic to identify turning vehicles • Meets FMVSS 108 Front and Rear Turn requirements  
 • Auxiliary for midturn and/or wide turn indications • Surface mount for easy installation • UV-coated lens prevents weathering from the elements  
 • Mounts with #10 screws

**53883** Yellow, Turn Lamp

**Material:** Polycarbonate

**Regulations / Standards:** FMVSS 108 / SAE I

**Finish:** Yellow

**Volts / Amps:** 12V / .327A

**Bracket:** 93982

**VMRS Code:** 034-003-071

**7" DOUBLE-FACE PEDESTAL LAMP**

For simultaneous front and rear warning • Pedestal mounting • Baked black enamel finish

**TURN:**

**78153** Yellow and Yellow

**Material:** Lens - Acrylic; Housing - Steel

**Regulations / Standards:** FMVSS 108 / SAE I

**Finish:** Yellow

**Bulb:** 1156, 32 CP

**Volts / Amps:** 12V / 2.1A (I)

**Pigtail:** 68080

**Lens:** 90093

**VMRS Code:** 034-002-013

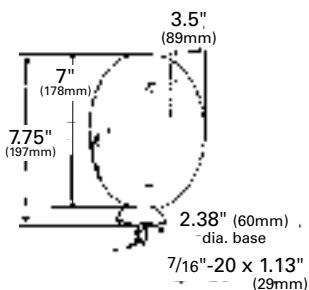

## 7" SINGLE-FACE LAMP

Two-stud or bracket mounting • Heavy-gauge formed steel housing  
• Yellow arrow design for rear turn only • 78303 and 78313 not for front turn use

- 78003** Yellow
- 78303** Yellow, Arrow Lens, Molded .180 Terminal Pigtail
- 78313** Yellow, Arrow Lens, Blunt Cut Pigtail

**Material:** Lens - Acrylic; Housing - Steel  
**Regulations / Standards:** FMVSS 108 / SAE I  
**Finish:** Yellow / Black  
**Bulb:** 1156, 32 CP  
**Volts / Amps:** 12V / 2.1A  
**Bracket:** 43282, 93982  
**Pigtail:** 68080  
**Lens:** Yellow 90093; Arrow Lens - Yellow 90103  
**VMRS Code:** 034-003-071

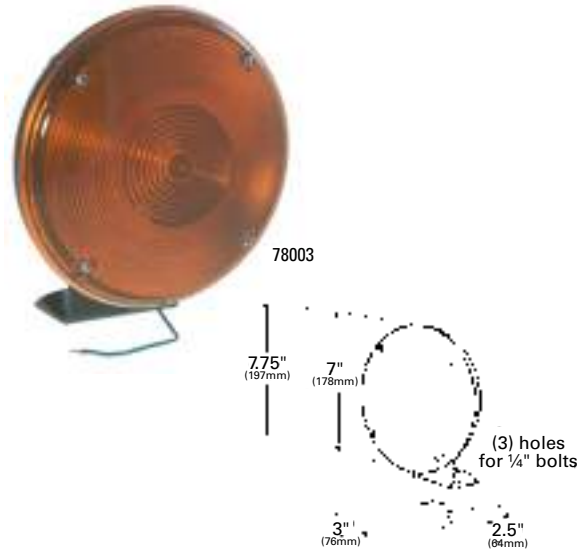

## 7" SCHOOL BUS LAMPS

Rugged housing • Acrylic lens • Flush mount • Blunt cut wires

### SINGLE CONTACT:

- 56072** Red
- 56073** Yellow
- 56083** Yellow w/ Arrow Lens

### DOUBLE CONTACT:

- 50132** Red

**Material:** Lens - Acrylic; Housing - Steel  
**Regulations / Standards:** FMVSS 108 / SAE I, S, T (56072, 50132)  
 FMVSS: I (56073, 56083)  
**Finish:** Red / Yellow / Black  
**Volts / Amps:** Bulb 1157, 32/3 CP (x2) (50132): 12V / 2.1A (I, S) / .59A (T) Double Contact  
 Bulb 1156, 32 CP (56072, 56073, 56083): 12V / 2.1A (I, S) Single Contact  
**Lens:** Red 99842, Yellow 99843  
**VMRS Code:** 034-003-071

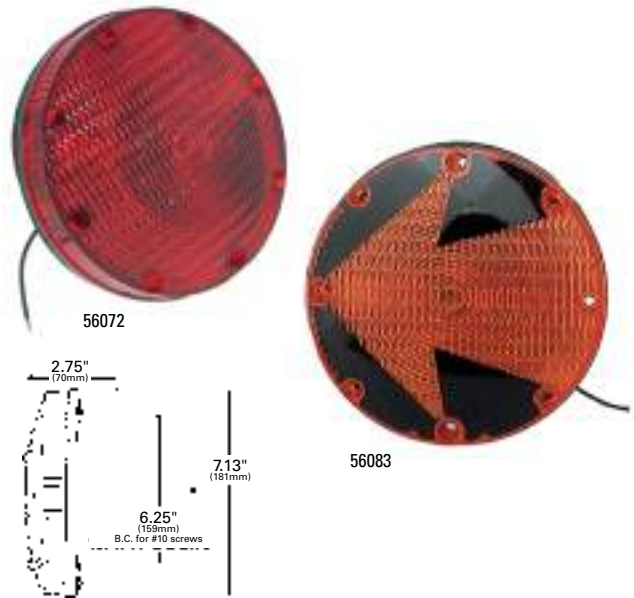

## PIGTAILS FOR 4" ROUND & 6" OVAL STOP/TAIL/TURN

For more information on pigtail products see **Pigtails** section: page 254

### STOP/TAIL/TURN THREE-WIRE PLUG-IN PIGTAILS FOR MALE PIN LAMPS

- 66815 6" Long, Ground Return, Slim-Line .180 Male
- 66841 8" Long, Chassis Ground, Slim-Line .180 Male
- 67002 11" Long, Chassis Ground, Blunt Cut Wire



### STOP/TAIL/TURN THREE-WIRE 90° PLUG-IN PIGTAILS FOR MALE PIN LAMPS

- 66816 6" Long, Ground Return System, 90° Plug, Slim-Line .180 Male
- 66845 8" Long, Chassis Ground, 90° Plug, Slim-Line .180 Male
- 67005 11" Long, Chassis Ground, 90° Plug, Blunt Cut Wires



### SINGLE FUNCTION TWO-WIRE PLUG-IN PIGTAILS FOR MALE PIN LAMPS

- 67013 11" Long, Chassis Ground, Blunt Cut Wire
- 66842 10" Long, Chassis Ground, Slim-Line .180 Male



### SINGLE FUNCTION TWO-WIRE 90° PLUG-IN PIGTAILS FOR MALE PIN LAMPS

- 66846 10" Long, Chassis Ground, 90° Plug, Slim-Line .180 Male
- 67016 11" Long, Chassis Ground, 90° Plug, Blunt Cut Wires



### STOP/TAIL/TURN THREE-WIRE PLUG-IN PIGTAILS FOR FEMALE PIN LAMPS

- 66812 6" Long, Chassis Ground, Slim-Line .180 Male
- 66825 8" Long, Ground Return, Slim-Line .180 Male
- 67000 11 1/2" Long, Chassis Ground, Blunt Cut Wires



### STOP/TAIL/TURN THREE-WIRE 90° PLUG-IN PIGTAILS FOR FEMALE PIN LAMPS

- 66811 18" Long, Chassis Ground, Slim-Line .180 Male, Star Ring Terminal
- 66843 18" Long, Chassis Ground, Blunt Cut Wires, Star Ring Terminal
- 66844 18" Long, Ground Return, Slim-Line .180 Male



### UNIVERSAL 3-WIRE 90° PLUG-IN PIGTAIL FOR FEMALE-PIN LAMPS

- 67090 13" Long, Chassis Ground, 90° Plug, Blunt Cut Wires
- 67090-5 13" Long, Chassis Ground, 90° Plug, Blunt Cut Wires **RETAIL**



### ADAPTER PLUGS

- 66830 6" Long, Female Pin to Male Pin Lamp Termination
- 66831 6" Long, Male Pin to Female Pin Lamp Termination
- 66836 6" Long, Female Pin to 90° Male Pin Lamp Termination



## PIGTAILS FOR 4" ROUND & 6" OVAL STOP/TAIL/TURN

For more information on pigtail products see **Pigtails** section: page 254

### TWO-WIRE PLUG-IN PIGTAILS FOR FEMALE-PIN LAMPS

#### STRAIGHT:

- 67010** 11 1/2" Long, Chassis Ground, Blunt Cut
- 67011** 10 1/4" Long, Chassis Ground, Standard .180 Male

#### 90° PLUG:

- 67014** 10" Long, Chassis Ground, Blunt Cut
- 67020** 10" Long, Ground Return, Slim-Line .180 Male



### HARD-SHELL CONNECTOR PIGTAILS

#### DUAL FUNCTION:

- 66861** 11" Long, Chassis Ground, Blunt Cut Wires

#### SINGLE FUNCTION:

- 66862** 11" Long, Chassis Ground, Blunt Cut Wires



### TWO LAMP 9" Y ADAPTER PIGTAILS

#### 90° PLUG:

- 66814** 9" Long, Adapter, Female-to-Male Pin

#### STRAIGHT:

- 66810** 9" Long, Adapter, Female-to-Female Pin
- 66813** 9" Long, Adapter, Male-to-Male Pin

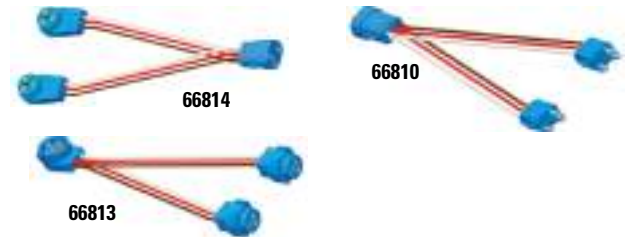

### MIDTURN ADAPTER PIGTAILS

- 66820** Adapter, Female-to-Female Pin, (2) Additional Standard .180 Receptacles
- 66823** Adapter, Male-to-Male Pin, (2) Additional Standard .180 Receptacles



### ADAPTER PLUGS FOR HARD SHELL CONNECTORS

#### COMPETITIVE HARNESS TO MALE PIN:

- 67006** 6" Long, Hard Shell to Male Pin Connector

#### FEMALE PIN HARNESS TO AMP CONNECTOR:

- 66860** 6" Long, Female Pin to Hard Shell Connector



### COMBO PIGTAILS (4" ONLY)

#### 4" WITH INTEGRATED BACK-UP

- 66863** Converter for Male Pin Lamps (10" Long)
- 66864** Converter for Female Pin Lamps (10" Long)
- 66865** Converter for Hard Shell Lamps (10" Long)
- 01-6686-E3** Ring Terminals to Lamp Termination

#### 4" W/O INTEGRATED BACK-UP

- 66442** Converter for Male Pin Lamps, 10"
- 66443** Converter for Female Pin Lamps, 10"
- 66444** Converter for Hard Shell Lamps, 10"





## 4" MOUNTING OPTIONS

For more information on mounting products see **Mounting Options** section: page 264



### SNAP-IN COVER PLATES

- 94380-4 4" Round Gray, Pair Pack
- 94382-4 4" Round Black, Pair Pack

**Material:** Polycarbonate



### RECESSED MOUNTING GROMMET FOR 4" ROUND LAMPS

- 91740 Grommet

**Material:** PVC  
**Finish:** Black



### CLOSED-BACK RECESSED MOUNTING GROMMET FOR 4" ROUND LAMPS

- 91950 Grommet

**Material:** PVC  
**Finish:** Black



### STAINLESS STEEL SNAP-IN THEFT-RESISTANT MOUNTING FLANGE FOR 4" ROUND LED LAMPS

- 93683 Stainless Steel

**Material:** Stainless Steel  
**Finish:** Stainless Steel



### SNAP-IN THEFT-RESISTANT MOUNTING FLANGE FOR 4" ROUND LED LAMPS

- 93552 Black
- 93553 Chrome-Plated

**Material:** ABS  
**Finish:** Black/Chrome



### THEFT-RESISTANT MOUNTING FLANGE FOR 4" ROUND LAMPS

- 92510 White, Polycarbonate
- 92512 Black, Polycarbonate
- 92513 Chrome-Plated, ABS
- 92511 Gray, Polycarbonate
- 43253 Stainless Steel

### SECURITY RING

- 43343 Stainless Steel Security Ring (must be used with flange)

**Material:** Polycarbonate; Stainless Steel; ABS



### ANGLED MOUNTING BRACKET FOR 4" ROUND LAMPS

- 43572 Black, 90° angle bracket

**Material:** Steel  
**Finish:** Black Powder-Coated  
**Grommet:** 91740



### MOUNTING MODULE FOR 4" ROUND LAMPS

- 43655 Yellow Zinc
- 51090 Gray

**Material:** Steel  
**Finish:** Yellow Zinc/Gray Powder-Coated



### 2-LAMP MOUNTING MODULE FOR 4" ROUND LAMPS

- 43642 Black, Powder-Coated

**Material:** Steel  
**Finish:** Black



### MOUNTING MODULE FOR 4" ROUND LAMPS

- 43732 Black

**Material:** Steel  
**Finish:** Black



### SNAP RING

- 99593 Use with 50222 and 50352
- 99595 Use with 50232

**Material:** Stainless Steel  
**Finish:** Stainless Steel



## 6" MOUNTING OPTIONS

For more information on mounting products see **Mounting Options** section: page 264



### SNAP-IN COVER PLATES

- 94390-4 6" Oval Gray, Pair Pack
- 94392-4 6" Oval Black, Pair Pack

**Material:** Polycarbonate



### RECESSED MOUNTING GROMMET FOR 6" OVAL LAMPS

- 92420 Open Grommet
- 92720 Closed Back Grommet

**Material:** PVC  
**Finish:** Black



### SURFACE MOUNT SNAP-IN BRACKET FOR 6" OVAL LAMPS

- 42152 Black, Polycarbonate
- 42153 Chrome, ABS

**Material:** Polycarbonate/ABS  
**Finish:** Black/Chrome



### SURFACE MOUNT BRACKET FOR 6" OVAL LAMPS

- 43172 Black

**Material:** Polycarbonate  
**Finish:** Black



### THEFT-RESISTANT MOUNTING FLANGE FOR 6" OVAL LAMPS

- 43220 Gray, Polycarbonate
- 43222 Black, Polycarbonate
- 43223 Chrome-Plated, ABS
- 43723 Stainless Steel

**Material:** Polycarbonate/Stainless Steel/ABS  
**Finish:** Gray/Black/Stainless Steel/Chrome



### ANGLED MOUNTING BRACKET FOR 6" OVAL LAMPS

- 43362 Black, 90° angle bracket

**Material:** Steel  
**Finish:** Black  
**Grommet:** 92420



### "Z" MOUNTING BRACKET FOR 6" OVAL LAMPS

- 43952 Black

**Material:** Steel  
**Finish:** Black  
**Grommet:** 92420

## REPLACEMENT LENSES

| LENS MODEL NUMBER | FITS LAMP    | LENS MODEL NUMBER | FITS LAMP |
|-------------------|--------------|-------------------|-----------|
| <b>90012</b>      | 50222        | <b>91302</b>      | 50902     |
|                   | 50232        |                   | 50912     |
|                   | 50352        |                   | 50942     |
|                   | 50502        |                   | 50952     |
|                   | 52522        |                   | 50972     |
|                   | 55132        |                   | 50992     |
|                   | 55202        |                   | 52602     |
| <b>90013</b>      | 50222        |                   | 52802     |
|                   | 50232        |                   | 52812     |
|                   | 50352        |                   | 52832     |
|                   | 50502        |                   | 52902     |
|                   | 52522        |                   | 52912     |
|                   | 55132        |                   | 52972     |
|                   | 55202        |                   | 53702     |
| <b>90103</b>      | 78003        |                   | 53712     |
| <b>90232</b>      | 50630        |                   | 53722     |
|                   | 50862        | <b>91482</b>      | 50852     |
|                   | 55220        |                   | 50862     |
|                   | 55232        |                   | 50872     |
|                   | 55280        | <b>91502</b>      | 55410     |
|                   | 55290        |                   | 55420     |
|                   | <b>90233</b> | 50630             |           |
| 55220             |              |                   | 55460     |
| 55280             |              |                   | 55470     |
| 55290             |              | <b>91503</b>      | 55410     |
| <b>90252</b>      | 50852        |                   | 55420     |
|                   | 50862        |                   | 55450     |
|                   | 50882        |                   | 55460     |
|                   | 50892        |                   | 55470     |
|                   |              | <b>91513</b>      | 55340     |
| <b>90482</b>      | 55340        |                   | 55410     |
| <b>90483</b>      | 55340        |                   | 55420     |
|                   | 64241        |                   | 55450     |
|                   | 64251        |                   | 55460     |
|                   | 64261-4      |                   | 55470     |
|                   | 64271        | <b>91582</b>      | 53000     |
|                   | 64281        |                   | 53020     |
|                   | 64291-4      |                   | 53052     |
| <b>90762</b>      | 52522        |                   | 56000     |
|                   |              |                   | 56020     |
|                   |              | <b>91583</b>      | 53000     |
|                   |              |                   | 53020     |
|                   |              |                   | 53023     |
|                   |              |                   | 56000     |
|                   |              |                   | 56020     |
|                   |              | <b>92062</b>      | G5300     |
|                   |              | <b>92063</b>      | G5300     |
|                   |              | <b>99842</b>      | 56072     |
|                   |              |                   | 50132     |
|                   |              | <b>99843</b>      | 56073     |



90012, 90013



90103



90232, 90233



90252



90482, 90483



90762



91302



91482



91502, 91503



91513



91582, 91583



92062, 92063



99842, 99843

Freightliner® is a registered trademark of Daimler Trucks North America, LLC; Navistar® is a registered trademark of Navistar International Corporation; Fontaine® is a registered trademark of Fontaine Truck Equipment Company; GM® is a registered trademark of General Motors LLC; Jeep® is a registered trademark of FCS US LLC; Peterbilt® is a registered trademark of PACCAR Inc DBA Peterbilt Motors Company; Chevrolet® is a registered trademark of General Motors LLC; Wrangler® is a registered trademark of FCS US LLC; GMC® is a registered trademark of General Motors LLC; Dodge® is a registered trademark of FCA US LLC; Packard® is a registered trademark of DELPHI TECHNOLOGIES, INC.; Ford® is a registered trademark of Ford Motor Company CORPORATION DELAWARE; Metri-Pack® is a registered trademark of Aptiv Technologies Limited COMPANY BARBADOS; Mack®; Volvo®

All product and company names are trademarks™ or registered® trademarks of their respective holders. Use of them does not imply any affiliation with or endorsement by them.

# ***SIGN-UP FOR GROTE'S ENHANCED G24/7 VISIT [ORDERS.GROTE.COM](http://ORDERS.GROTE.COM)***



Grote® Industries is pleased to announce the launch of the enhanced G24/7 system. This complimentary service is an innovative way to place orders, track order status and view all your Grote® product activity. From the convenience of your computer or mobile device, you can now access previously unavailable information that will help you more successfully manage your business and inventory.

## ***ORDERS.GROTE.COM***

### **NEW FEATURES**

- ***PAY ANY INVOICE ONLINE ANY TIME***
- ***EASY CREDIT CARD PROCESSING***
- ***NOW MOBILE FRIENDLY***
- ***REPRINT PACKING LISTS AND INVOICES***



#### ***UPLOAD FROM MICROSOFT® EXCEL***

Customers can also upload items from Microsoft® Excel to create orders.

#### ***REFER AND REORDER USING "MY LIST"***

The user can create a list of products for future reference or to reorder.

#### ***E-MAIL NOTIFICATION***

When a new order is created and when an order is shipped, unlimited recipients can receive an instant e-mail notification.

#### ***ORDER ENTRY ONLINE BY CUSTOMER PART NUMBER***

### ***USING G24/7, YOU CAN QUICKLY AND EASILY:***

- Track the status of current orders
- Check the status of backorders
- Check for substitutions or replacements for obsolete parts
- Check Grote® inventory availability
- Confirm ship dates
- Link to shipping carrier
- View invoice information
- Track credits
- View weight & packaging information
- View previously placed orders
- View product technical information
- Reprint packing lists and invoices



# 03

## LIGHT DUTY TRAILER LIGHTING

*ÉCLAIRAGE POUR REMORQUE LÉGÈRE*

*ILUMINACIÓN PARA REMOLQUE,  
PARA TRABAJO LIVIANO*

### SUBMERSIBLE LED TRAILER LIGHTING KIT

7-function tail lamps: stop/tail/turn, side/rear reflector clearance/marker and license lamp • Kit includes lamps, 4' vehicle and 25' trailer harness, license bracket, and mounting hardware

**65880-5** w/o Clearance/Marker **RETAIL**

**REPLACEMENT LAMP:**

- 51962** Red, RH, S/T/T
- 51962-5** Red, RH, S/T/T **RETAIL**
- 51972** Red, LH, S/T/T w/ License Window
- 51972-5** Red, LH, S/T/T w/ License Window **RETAIL**

**Material:** Polypropylene/Acrylic/ABS  
**Regulations / Standards:** FMVSS 108 / RH - SAE A, I, P2, S, T; LH - SAE A, I, L, P2, S, T; C/M - SAE P2  
**Finish:** Red/Yellow  
**Volts / Amps:** S/T/T - 12V / .22A (per lamp); C/M - 12V / .11A (per lamp)  
**Bracket:** 43262-5  
**Harness:** 68420 (trailer)  
 68540-5 (complete)  
**VMRS Code:** 034-002-059 - 65880-5, 51962, 51962-5, 51972, 51972-5

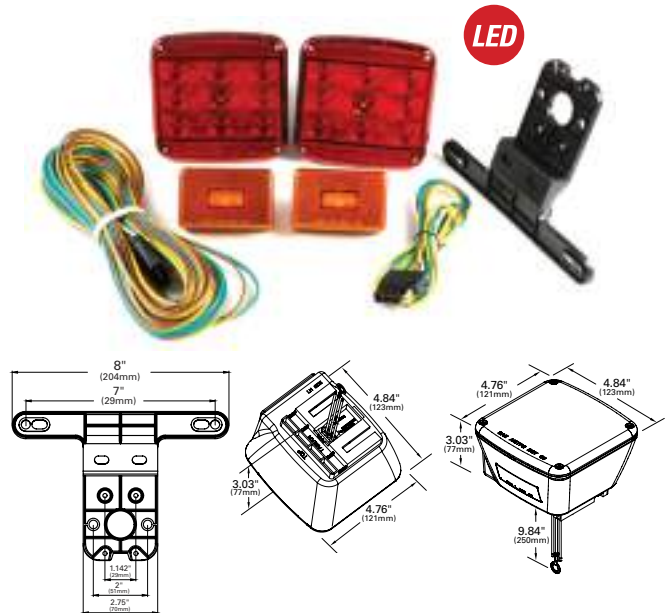

### SUBMERSIBLE LED TRAILER LIGHTING KIT

Popular square design • 7-function kit • Kit includes lamps, trailer harness, license bracket and mounting hardware • Retail kit includes "try me" feature

**65330-5** w/ Clearance/Marker **RETAIL**  
**65320-5** w/o Clearance/Marker **RETAIL**

**REPLACEMENT LAMP:**

- 51982** Red, RH, S/T/T
- 51982-5** Red, RH, S/T/T **RETAIL**
- 51992** Red, LH, S/T/T
- 51992-5** Red, LH, S/T/T **RETAIL**
- 47853-5** Yellow, C/M **RETAIL**

**Material:** Polypropylene/Acrylic/ABS  
**Regulations / Standards:** FMVSS 108 / RH - SAE A, I, P2, S, T; LH - SAE A, I, L, P2, S, T; C/M - SAE P2  
**Finish:** Red/Yellow  
**Volts / Amps:** S/T/T - 12V / .22A (per lamp); C/M - 12V / .11A (per lamp)  
**Bracket:** 43262-5  
**VMRS Code:** 034-002-013 - 65330-5, 65320-5  
 034-002-022 - 51982, 51982-5, 51992, 51992-5  
 034-004-021 - 47853-5





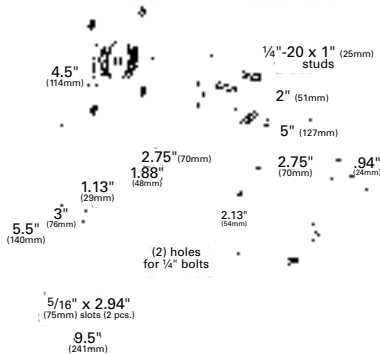

## SUBMERSIBLE TRAILER LIGHTING KIT

7-function tail lamps: stop/tail/turn, clearance/marker, license, and reflector

- Kit includes 25' harness, lamps, license bracket and mounting hardware

65230-5 w/ Clearance/Marker

**RETAIL**

### REPLACEMENT PARTS:

53662 Red, RH, S/T/T

53672 Red, LH, S/T/T

46982-5 Red, C/M

46983-5 Yellow, C/M

**RETAIL**

**RETAIL**

**Material:** Acrylic / ABS / Polypropylene

**Regulations / Standards:** FMVSS 108 / RH - SAE A, I, P2, S, T; LH - SAE A, I, L, P2, S, T; C/M - SAE P2

**Finish:** Red / Yellow

**Bulb:** STT - 1157; Volts / Amps: 12V / 2.1A (I, S) / .59A (T) / .27A (P2) per lamp

**Bulb:** C/M - 1895, 2 CP; Volts / Amps: 12V / .27A (P2) per lamp

**Lens:** S/T/T - Red 92792

Sidemarkers and Clearance/Marker Red 91112, Yellow 91113

**VMRS Code:** 034-002-013 - 65230-5

034-002-022 - 53662, 53672

034-004-021 - 46982-5, 46983-5

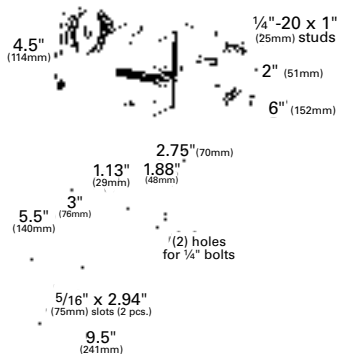

## SUBMERSIBLE TRAILER LIGHTING KIT FOR TRAILERS OVER 80" WIDE

7-function tail lamps: stop/tail/turn, clearance/marker, license, and reflector

- Kit includes 25' harness, lamps, license bracket and mounting hardware

65440-5 Trailer Kit

**RETAIL**

**Material:** Acrylic / ABS / Polypropylene

**Regulations / Standards:** FMVSS 108 / S/T/T RH - SAE A, I, P2, P3, S, T; S/T/T LH - SAE A, I, P2, P3, L, S, T

**Finish:** Red

**Bulb:** 1157, 168 CP; Volts / Amps: 12V / .59A

**Accessory:** Harness: 68420

**Bracket:** 43262-5

**Lens:** S/T/T - Red 92792; C/M - Red 91122

**VMRS Code:** 034-002-013 - 65440-5

### TRAILER LIGHTING KIT (NON-SUBMERSIBLE)

Twist-in bulb design makes it easy to replace • Kit includes lamps, 25' harness, license plate bracket, and complete wiring and installation kit

- 65370-5 w/ Clearance/Marker
- 65380-5 w/o Clearance/Marker

**REPLACEMENT PARTS:**

- 52302 Red, RH, S/T/T
- 52302-5 Red, RH, S/T/T
- 52312 Red, LH, S/T/T
- 52312-5 Red, LH, S/T/T
- 46983-5 Yellow, Clearance/Marker
- 52442 Red, RH, S/T/T and C/M, Over 80"
- 52452 Red, LH, S/T/T w/ License Window and C/M, Over 80"

**Material:** Acrylic, ABS, Polypropylene

**Regulations / Standards:** FMVSS 108 / SAE A, I, L, P2, S, T  
 SAE A, I, P2, P3, S, T (52442)  
 SAE A, I, L, P2, P3, S, T (52452)

**Finish:** Red/Yellow

**Bulb:** S/T/T - 1157, 32/3 CP; Volts / Amps: 12V / 2.1A (I, S) / .59 (T)

**Bulb:** Marker - 1895, 2 CP; Volts / Amps: 12V / .27A (P2)

**Lens:** S/T/T - Red 92792; Clearance/Marker; Red 91112; Yellow 91113

**VMRS Code:** 034-002-022 - 65380-5, 52302, 52302-5, 52313, 52312-5, 65370-5  
 034-004-021 - 46983-5

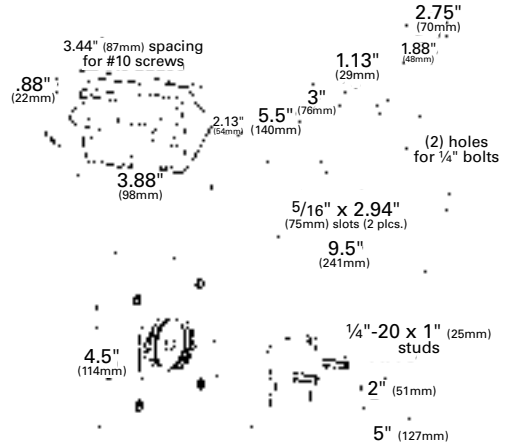

LED

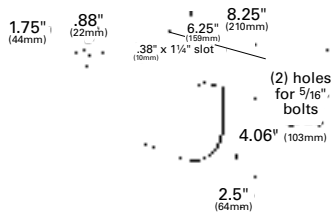

### SUPERNOVA® LED OVAL TRAILER STOP/TAIL/TURN SUBMERSIBLE LIGHTING KIT

Kit includes two each of: LED lamps (54132), brackets (43362), grommets (92420) and 3-wire, 11" plug-in pigtails (67002) • Fits current mounting flanges and grommets

65390-5 Red **RETAIL**

**Material:** ABS / Acrylic / Steel / PVC

**Regulations / Standards:** FMVSS 108 / SAE I, S, T

**Finish:** Red

**Volts / Amps:** 12V / .48A (I, S) / .06A (P2, T) per lamp

**Accessory:** Lamp: Red 54132

**Bracket:** 43362

**Grommet:** 92420

**Pigtail:** 67002

**VMRS Code:** 034-002-013

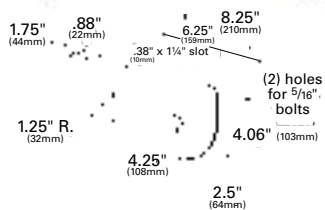

### OVAL TRAILER STOP/TAIL/TURN SUBMERSIBLE LIGHTING KIT

Kit includes two of each: lamps (52182), brackets (43362), grommets (92420) and 3-wire 11" plug-in pigtails (67000)

#### BOAT TRAILER KIT:

53082-5 **RETAIL**

**Material:** Steel / Polycarbonate / PVC

**Regulations / Standards:** FMVSS 108 / SAE I, S, T

**Finish:** Red

**Bulb:** 1157, 32/3 CP

**Volts / Amps:** 12V / 2.1A (I, S) / .59A (T) per lamp

**Accessory:** Lamp: Red 52182

**Bracket:** 43362

**Grommet:** 92420

**Pigtail:** 67000

**VMRS Code:** 034-002-013

## SUBMERSIBLE LOW-PROFILE TRAILER LIGHTING KIT

Unique compact size fits where space is limited • Lens is sonically sealed to make a fully submersible lamp • 5-function tail lamps: stop/tail/turn, license, and reflector • Kit includes: Lamps, 4' trunk and 25' trailer harness, license bracket, and mounting hardware

65300-5 Red

RETAIL

### REPLACEMENT PARTS:

52492 Red, LH, S/T/T w/ License Window

52482 Red, RH, S/T/T

90652 Lens Kit (2 S/T/T and 2 C/M)

**Material:** ABS/Acrylic

**Regulations / Standards:** FMVSS 108 / RH - SAE A, I, S, T; LH - SAE A, I, L, S, T

**Finish:** Red

**Volts / Amps:** 12V / 2.1A, .48A

**Bracket:** 01-9321-20

**VMRS Code:** 034-002-013 - 65300-5, 52492, 52482  
034-002-014 - 90652

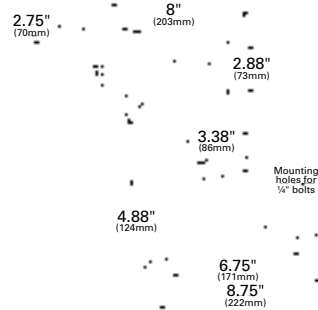

## LARGE WRAP-AROUND 5-FUNCTION REAR LAMP

For utility and snowmobile trailers • 5-function lamp: stop/tail/turn, clearance marker and reflector

52372 Right-Hand

52362 Left-Hand

**Material:** Polypropylene/Acrylic

**Regulations / Standards:** FMVSS 108 / SAE A, I, P2, S, T

**Finish:** Red

**Bulb:** 1157, 32/3 CP; Volts / Amps: 12V / .59A (T) / .27A (P2)

**Bulb:** 1895, 2 CP; Volts / Amps: 12V / 2.1A (I, S)

**Lens:** Kit - Red 92382

**VMRS Code:** 034-002-022

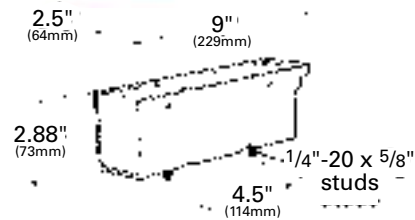

## HEAVY DUTY SUPERNOVA® LED MAGNETIC TOWING KIT

Durable rubber housings • Strong 50 lb.-pull mounting magnets for each lamp • Rubber adhesive magnet covers prevent scratching paint of towed vehicle • Adjustable lamp mounting for maximum visibility and safety • Die-cast 4-pole round plug • 30 ft. abrasion-resistant jacketed cable

65432-4 Red

**Material:** Rubber/ABS/Acrylic

**Regulations / Standards:** FMVSS 108 / SAE I, P2, S, T

**Finish:** Red

**Volts / Amps:** 12V / .24A (I, S) / .03A (P2, T) per lamp

**Accessory:** Lamp: Red 53252; Magnetic Mount: 43300; Plug: 82-1021; Vehicle Socket: 82-1020

**VMRS Code:** 034-002-022

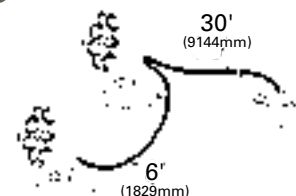

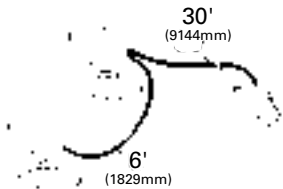

## HEAVY DUTY MAGNETIC TOWING KIT

Durable rubber lamp housings • Strong 40 lb. mounting magnets for each lamp  
 • Rubber adhesive magnet covers to prevent scratching of towed vehicle • Adjustable lamp mounting for maximum visibility and safety • Durable die-cast 4-pole plug • 30 ft. abrasion resistant double jacketed cable

**65402-4** Red

**Material:** Rubber/Polycarbonate

**Regulations / Standards:** FMVSS 108 / SAE I, P2, S, T

**Finish:** Red/Black

**Bulb:** (2) #2057, 32/2 C.P.; Volts / Amps: 12 V / .48A (P2, T) / 2.1A (I, S) per lamp

**Accessory:** Lamp: Red 52922; Magnetic Mount: 43300; Plug: 82-1021; Vehicle Socket: 82-1020

**VMRS Code:** 034-002-022

LED

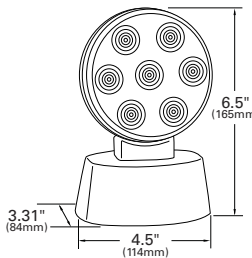

## MAGNETIC LED TOWING KIT

Kit includes lamps, harness and hook-up connectors • Kit specifications include truck harness and 20 ft. connecting harness • Plugs into a standard flat four-way vehicle trailer light connector

**65720-5** Red

RETAIL

**Material:** ABS/Acrylic/Polycarbonate/PVC

**Regulations / Standards:** FMVSS 108 / SAE I, P2, S, T

**Finish:** Red

**Volts / Amps:** 12V / .25A (I, S) / .04A (P2, T)

**VMRS Code:** 034-002-013

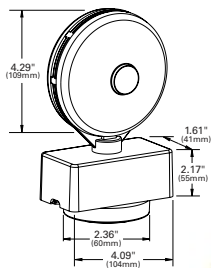

## MAGNETIC TOWING KIT

Kit includes harness, lamp and hook-up connectors • Kit specifications include truck harness and 20 ft. connecting harness • Plugs into a standard, flat four-way vehicle trailer light connector • Lens and bulb are replaceable

**65730-5** Red

RETAIL

**Material:** ABS/Acrylic

**Regulations / Standards:** FMVSS 108 / SAE I, P2, S, T

**Finish:** Red

**Bulb:** (2) 32 CP, 1157; Volts / Amps: 12V / 2.1A (I, S) / .59A (P2, T)

**Lens:** 90232

**VMRS Code:** 034-002-013



## TRAILER WIRING FRAME CLIP

Holds wire harness to frame and trailer

**99460-5** 10-Pack

RETAIL

**Material:** Spring Steel

**Finish:** Black

**VMRS Code:** 034-004-023



### 25' SPLIT-WIRE HARNESS

4-wire, split-Y trailer harness with male connector

**68420** Wire Harness

VMRS Code: 034-001-012



### BOAT & UTILITY TRAILER WIRING KIT

For durable re-wiring of boat, bike, snowmobile, or utility trailers

- A complete wire-harness package: 25' trailer harness, 4' trunk harness and six no-splice connectors

**68540-5** RETAIL

VMRS Code: 034-001-012



### REPLACEMENT LENSES

| LENS MODEL NUMBER | FITS LAMP          | LENS MODEL NUMBER | FITS LAMP      |
|-------------------|--------------------|-------------------|----------------|
| <b>90342</b>      | 50532              | <b>91122</b>      | 52442<br>52452 |
| <b>90652</b>      | 52482<br>52492     | <b>92792</b>      | 52302<br>52312 |
| <b>91112</b>      | 50532              |                   |                |
| <b>91113</b>      | 65230-5<br>65370-5 |                   |                |



90342



90652



91112, 91113



91122



92792

# 04

## LICENSE AND BACK-UP

*FEUX DE PLAQUE  
D'IMMATRICULATION ET DE RECUL*

*LÁMPARAS DE PLACA / REVERSA*



## MICRONOVA® MULTI-VOLT LED LICENSE LAMP

Durable one-piece LED lamp design • Hardwire with .180 slim-line ULTRA-BLUE-SEAL® plug connections for maximum performance  
 • Indexed, snap-fit mounting to brackets • Angled drain slots to prevent buildup behind the light • Direct replacement to existing 60601 (LED) and 60261 (incandescent) offerings

**60671** Lamp Only **ECE** **MULTI**

### VERTICAL MOUNT KIT:

**60701** Black (60671 + 43962) **ECE** **MULTI**  
**60681** Gray (60671 + 43960) **ECE** **MULTI**  
**60781** Gray (60671 + 42332) **ECE** **MULTI**  
**60791** Black (60671 + 42322) **ECE** **MULTI**

### HORIZONTAL MOUNT

**60691** Black (60671 + 42162) **ECE** **MULTI**

**Material:** Polycarbonate  
**Regulations / Standards:** FMVSS 108, ECE R4 / SAE L  
**Finish:** Clear / Gray / Black  
**Volts / Amps:** 9–32V / .03A  
**Brackets:** 43960, 43962  
**VMRS Code:** 034-002-042



## MICRONOVA® MULTI-VOLT DOT LED LICENSE LAMP

Durable one-piece LED lamp design • Hardwire with .180 slim-line ULTRA-BLUE-SEAL® plug connections for maximum performance  
 • 60661 direct replacement to existing 60291 (incandescent) offering

**60721** Lamp w/ Hooded Grommet **ECE** **MULTI**  
**60721-5** Lamp w/ Hooded Grommet **RETAIL** **ECE** **MULTI**  
**60861** Lamp w/ Hooded Grommet Deutsch® Connector **MULTI**  
**60661** DOT Lamp with Adaptor Bracket **ECE** **MULTI**  
**60651** DOT Lamp **ECE** **MULTI**

### KITS

**60711** Gray (60661 + 43780) **ECE** **MULTI**

**Material:** Lens and Bracket - Polycarbonate; Grommet - PVC  
**Regulations / Standards:** FMVSS 108, ECE R4 / SAE L  
**Finish:** Clear / Gray / Black  
**Volts / Amps:** 9–32V / .03A  
**Grommets:** 94360;  
**Brackets:** 43780, 43783  
**Adaptor Plate:** 94350  
**VMRS Code:** 034-002-042



LED

**SUPERNOVA® LED LICENSE LAMP**

Low-profile shape helps prevent damage from dock collisions • Vibration-resistant lamp is ideal for dump trucks, refuse haulers and cement mixers

- Slotted mounting holes fit most lamp mounting screw patterns and withstands excessive torque without cracking

**60381** Gray  
**60341** Black

**Material:** Polycarbonate  
**Regulations / Standards:** FMVSS 108 / SAE L  
**Finish:** Gray / Black  
**Volts / Amps:** 12V / .04A  
**VMRS Code:** 034-002-042

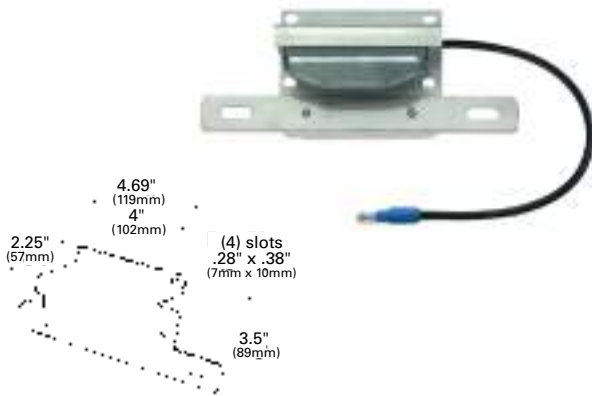
**RECTANGULAR LICENSE LAMP WITH BRACKET**

Aluminum lamp bracket and stainless steel license-plate bracket

- Complete assembly includes dual-function bracket, license lamp (60291), lamp bracket (43390) and 48", 14-gauge .180 bullet ULTRA-BLUE-SEAL® pigtail
- License bracket not sold separately

**60321** Clear w/ Stainless Steel Bracket

**Material:** Lens - Polycarbonate; Housing - Aluminum; Bracket - Stainless Steel  
**Regulations / Standards:** FMVSS 108 / SAE L  
**Finish:** Aluminum  
**Bulb:** 193, 2 CP (x2)  
**Volts / Amps:** 12V / .66A  
**Light:** 60291  
**VMRS Code:** 034-002-021

**SEALED TURTLEBACK® II LICENSE LAMP**

Impact-resistant bulb contacts • Waterproof male pin connection accepts ULTRA-BLUE-SEAL® pigtail

**60331** Clear

**Material:** Polycarbonate  
**Regulations / Standards:** FMVSS 108 / SAE L  
**Finish:** Clear  
**Bulb:** 193, 2 CP (x2)  
**Volts / Amps:** 12V / .66A  
**Pigtails:** 66910, 66911, 67070, 67071  
**VMRS Code:** 034-002-021

## 2" TWIST-IN SEALED LICENSE LAMP

Kit includes hooded mounting bracket with lamp • Twist-on mounting  
 • Accepts ULTRA-BLUE-SEAL® pigtail • Factory sealed

**45821** Clear

**KITS:**

**60191** Clear (45821 + 43040)

**Material:** Polycarbonate

**Regulations / Standards:** FMVSS 108 / SAE L when used with 43040 bracket

**Finish:** Clear

**Bulb:** 193, 2 CP

**Volts / Amps:** 12V / .33A

**Bracket:** 43040

**Pigtail:** 66850, 66851, 66800, 66840, 67001, 67050, 66801

**VMRS Code:** 034-002-021



## SMALL RECTANGULAR LICENSE LAMP

Sonically sealed lens design • Single 15,000-hour bulb

**LICENSE LAMPS:**

**60261** Clear

**LICENSE LAMP KITS:**

**60280** Clear (60261 + 43830)

**60460** Clear Lamp, Gray Flange (60261 + 43960)

**Material:** Polycarbonate

**Regulations / Standards:** FMVSS 108 / SAE L

**Finish:** Clear

**Bulb:** 2 CP

**Volts / Amps:** 12V / .33A

**Bracket:** 43830, 43960

**Pigtail:** 66850, 67050, 67001, 66851, 66800, 66840

**VMRS Code:** 034-002-021



## RECTANGULAR LICENSE LAMP

Sonically sealed rectangular double-bulb lamp • Narrow mounting applications • 15,000-hour bulbs

**60291** Clear

**Material:** Polycarbonate

**Regulations / Standards:** FMVSS 108 / SAE L

**Finish:** Clear

**Bulb:** 193, 2 CP (x2)

**Volts / Amps:** 12V / .66A

**Bracket:** 43780, 43783, 43850

**Pigtail:** 66980, 66981, 66982

**VMRS Code:** 034-002-021







60011

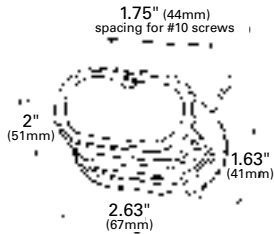

## RESEALABLE LICENSE LAMP

Compact license lamp protrudes less than 2" • Housing snaps firmly into molded O-ring

- 60001** Gray  
**60011** Triple Chrome  
**60011-5** Triple Chrome **RETAIL**  
**60121** Gray w/ UBS .180-Bullet Plug-In Pigtail

### PROTECTIVE LENS CAP:

- 93610** Gray

**Material:** Lens - Polycarbonate; Housing - Chrome-Plated ABS

**Regulations / Standards:** FMVSS 108 / SAE L

**Finish:** Gray / Chrome

**Bulb:** 67, 4 CP

**Volts / Amps:** 12V / .59A

**Accessory:** Gray Cap: 93610

**VMRS Code:** 034-002-021



## LICENSE LAMP WITH METAL BRACKET

Compact license lamp protrudes less than 2" • Housing snaps firmly into molded-in O-ring • Uses 60001 license lamp with 7" pigtail

- 60081** Clear

### PROTECTIVE LENS CAP:

- 93610** Gray

**Material:** Lens - Polycarbonate; Housing - Steel

**Regulations / Standards:** FMVSS 108 / SAE L

**Finish:** Black / Gray / Clear

**Bulb:** 67, 4 CP

**Volts / Amps:** 12V / .59A

**VMRS Code:** 034-002-021

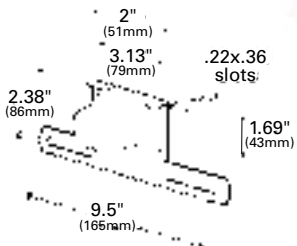

LED



## SUPERNOVA® 4" FLANGED LED HOOK UP LAMP

Directly mounts and replaces existing hook-up lamps • Sealed flange-to-lens design • Housing to truck gasket included to keep moisture and elements out • Male pin connection • Provides more light to hook up power and air in the nose box area than existing lamps

- 60631** Clear

**Material:** Polycarbonate

**Finish:** Clear

**Volts / Amps:** 12V / 0.5A

**Pigtail:** 66842, 67013, 66846

**VMRS Code:** 034-002-042

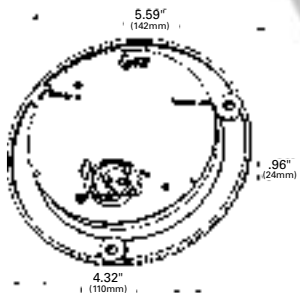

## SUPERNOVA® 4" SINGLE-SYSTEM LED BACK-UP LAMP

Meets back-up function with single-lamp system • Encapsulant potting for total circuit-board protection • Advanced pin connection system uses tin-plated, solid-brass pin terminals • Hard-coated lens for long-term UV protection

**62401** Clear, Male Pin

**Material:** Polycarbonate  
**Regulations / Standards:** FMVSS 108 / SAE R  
**Finish:** Clear  
**Volts / Amps:** 12V / .6A  
**Bracket:** 43343, 92510, 92512, 92513, 43253  
**Grommet:** 91740, 91950  
**Pigtail:** 66842, 67013, 66846, 66816  
**VMRS Code:** 034-003-142

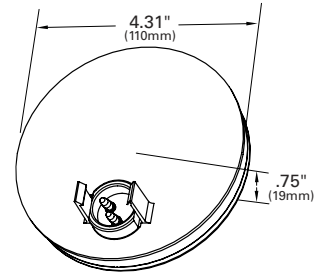

## 4" TORSION MOUNT® II SINGLE-SYSTEM BACK-UP LAMP

Torsion Mount® II Gel-Mount® bulb cradle design • Meets back-up function with single-lamp system • Hermetic lens-to-housing seal

**62211** Clear, Male Pin  
**62271** Clear, Female Pin

**KITS:**

**62331** Clear, Female Pin (62271 + 91740 + 67010)

**Material:** Polycarbonate  
**Regulations / Standards:** FMVSS 108 / SAE R  
**Finish:** Clear  
**Bulb:** 2057 32/2 CP  
**Volts / Amps:** 12V / 2.1A  
**Bracket:** 43572, 43253, 92510, 92512, 92513  
**Grommet:** 91740, 91950  
**Pigtail:** Male Pin: 66842, 67013, 66846  
 Female Pin: 67011, 67010, 67014, 67020  
**VMRS Code:** 034-003-074

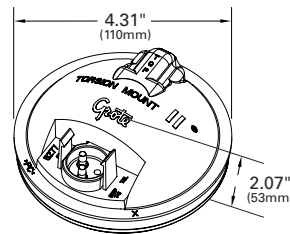

62211

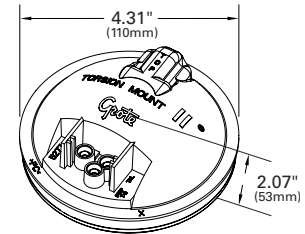

62271

## SUPERNOVA® 4" DUAL-SYSTEM LED BACK-UP LAMP

Requires two lamps to meet back-up function • Advanced pin connection system uses tin-plated, solid-brass terminations • Hard-coated lens for long-term UV protection

**62391** Clear  
**62571** Clear

**Material:** Polycarbonate  
**Regulations / Standards:** FMVSS 108 / SAE (2)R  
**Finish:** Clear  
**Volts / Amps:** 12V / .25A, 24V / .15A  
**Bracket:** 43343, 92510, 92512, 92513, 43253  
**Grommet:** 91740, 91950  
**Pigtail:** 66842, 67013, 66846, 66816  
**VMRS Code:** 034-003-142

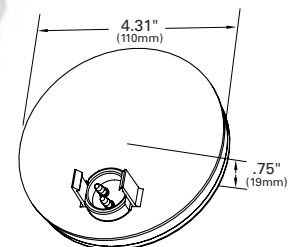

LED

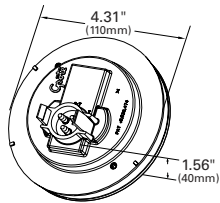

62091

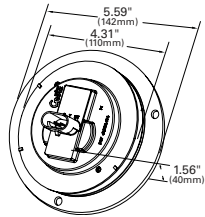

62791

LED

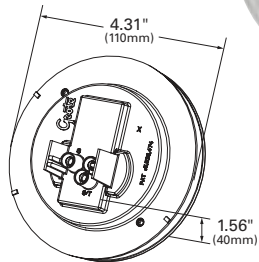

### SUPERNOVA® NEXGEN 4" DUAL-SYSTEM LED BACK-UP LAMP

Fits standard 4" lamp grommets and brackets • Hermetically sealed lamp prevents water intrusion • Requires two lamps to meet back-up function  
• Flanged lamps require no additional mounting brackets

**62091** Clear, Male Pin  
**62101** Clear, Hard Shell

#### FLANGED W/GASKET

**62791** Clear, Hard Shell **ECE**

**Material:** Lens - Acrylic; Housing - ABS

**Regulations / Standards:** FMVSS 108 / SAE (2)R

**Finish:** Clear

**Volts / Amp:** 12V / .55A

**Bracket:** 93552, 43253, 92510, 92511, 92513, 43572, 43642, 43655, 43732, 93553, 93683, 51090

**Grommet:** 91740, 91950

**Pigtail:** Male Pin: 66842, 67013, 66846, 66816; Hard Shell: 66862

**VMRS Code:** 034-003-142

### GROTE SELECT® 4" DUAL-SYSTEM LED BACK-UP LAMP

Fits standard 4" lamp grommets and brackets • Hermetically sealed lamp prevents water intrusion • Requires two lamps to meet back-up function  
• Standard aftermarket connection provides for ease of replacement

**62691** Female Pin

**Material:** Lens - Acrylic; Housing - ABS

**Regulations / Standards:** FMVSS 108 / SAE (2)R

**Finish:** Clear

**Volts / Amps:** 12V / .55A

**Bracket:** 93552, 43253, 92510, 92511, 92512, 92513, 43572, 43642, 43655, 43732, 93190, 93553, 93683, 51090

**Grommet:** 91740, 91950

**Pigtail:** 66812, 66811

**VMRS Code:** 034-003-142

### 4" TORSION MOUNT® II DUAL-SYSTEM BACK-UP LAMP

Requires two lamps to meet back-up function • Torsion Mount® II Gel-Mount® bulb cradle design • Hermetic lens-to-housing seal  
• Kit includes lamp, grommet (91740) and pigtail (67010)

**62121** Frosted Clear, Male Pin

**62171** Frosted Clear, Female Pin

**62321** Frosted Clear, Female Pin **24 Volt**

#### KITS:

**62181** Frosted Clear, Female Pin (62171 + 91740 + 67010)

**Material:** Polycarbonate

**Regulations / Standards:** FMVSS 108 / SAE (2)R

**Finish:** Frosted

**Volts / Amps:** Bulb 2057, 32 CP: 12V / 2.1A

**Bracket:** 43572, 43253, 92510, 92512, 92513

**Grommet:** 91740, 91950

**Pigtail:** Male Pin: 66842, 67013, 66846, 67016;  
Female Pin: 67010, 67014, 67011, 67020

**VMRS Code:** 034-003-074

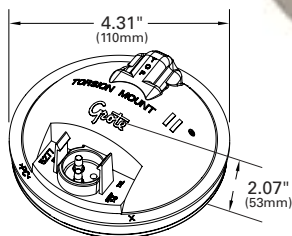

### SUPERNOVA® OVAL SINGLE-SYSTEM LED BACK-UP LAMP

Legal for horizontal mount only • Uses ULTRA-BLUE-SEAL® male pin pigtails  
 • Retrofit upgrade for original equipment Volvo® trucks using the Grote® tail lamp system • Encapsulant potting for total circuit board protection

**62561** Clear, Grommet Mount

**Material:** Lens - Acrylic; Housing - ABS  
**Regulations / Standards:** FMVSS 108 / SAE R  
**Finish:** Clear  
**Volts / Amps:** 12V / .30A  
**Bracket:** 43362, 43952, 43220, 43223, 43222, 43723, 43100  
**Grommet:** 92420, 92720  
**Pigtail:** 66842, 67013, 66846, 66816  
**VMRS Code:** 034-003-142

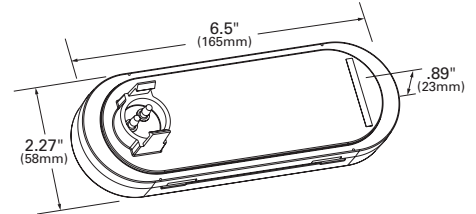

### SUPERNOVA® OVAL DUAL-SYSTEM LED BACK-UP LAMP

Requires two lamps to meet back-up function • Fewer diodes reduces power consumption • Uses ULTRA-BLUE-SEAL® male pin pigtails

**MALE PIN, HORIZONTAL MOUNT:**

**62601** Clear, Grommet Mount

**MALE PIN, VERTICAL MOUNT:**

**62591** Clear, Grommet Mount

**Material:** Lens - Acrylic; Housing - ABS  
**Regulations / Standards:** FMVSS 108 / SAE (2)R  
**Finish:** Clear  
**Volts / Amps:** 12V / .30A  
**Bracket:** 43362, 43952, 43220, 43223, 43222, 43723, 43100  
**Grommet:** 92420, 92720  
**Pigtail:** 66842, 67013, 66846, 66816  
**VMRS Code:** 034-003-142

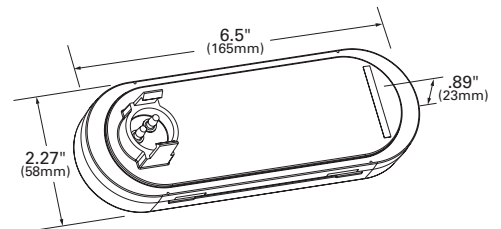

### SUPERNOVA® NEXGEN OVAL DUAL-SYSTEM LED BACK-UP LAMP

Fits standard oval lamp grommets and brackets • Hermetically sealed lamp prevents water intrusion • Requires two lamps to meet back-up function  
 • Lamps must be mounted vertically

**62051** Male Pin

**Material:** Lens - Acrylic; Housing - ABS  
**Regulations / Standards:** FMVSS 108 / SAE (2)R  
**Finish:** Clear  
**Volts / Amps:** 12V / .30A  
**Bracket:** 43362, 43952, 43220, 43223, 43222, 43723, 43100  
**Grommet:** 92420, 92720  
**Pigtail:** 66842, 67013, 66846, 66816  
**VMRS Code:** 034-003-142

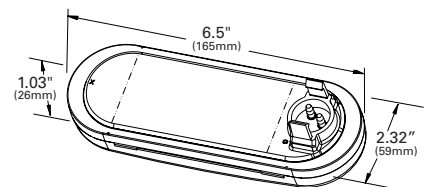

LED

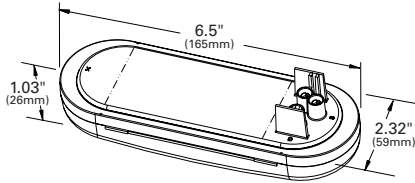

### GROTE SELECT® OVAL DUAL-SYSTEM LED BACK-UP LAMP

Fits standard oval lamp grommets and brackets • Hermetically sealed lamp prevents water intrusion • Requires two lamps to meet back-up function • Lamps must be mounted vertically • Product uses standard aftermarket connection for ease of installation

**62751** Female Pin

**Material:** Lens - Acrylic; Housing - ABS

**Regulations / Standards:** FMVSS 108 / SAE (2)R

**Finish:** Clear

**Volts / Amps:** 12V / .30A

**Bracket:** 43362, 43952, 43220, 43223, 43222, 43723, 43100

**Grommet:** 92420, 92720

**Pigtail:** 67010, 67011, 67014, 67020

**VMRS Code:** 034-003-142

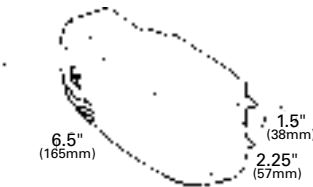

### TORSION MOUNT® III OVAL DUAL-SYSTEM BACK-UP LAMP

Fits standard oval lamp grommets and brackets • O-ring seal design eliminates corrosion (male pin) • Requires two lamps to meet back-up function

**62231** Clear, Female Pin

#### KITS:

**62251** Clear, Female Pin (62231 + 92420 + 67010)

**Material:** Polycarbonate

**Regulations / Standards:** FMVSS 108 / SAE (2)R

**Finish:** Clear

**Bulb:** 1157, 32 CP

**Volts / Amps:** 12V / 2.1A

**Bracket:** 43362, 43952, 43220, 43222, 43223

**Grommet:** 92420, 92720

**Pigtail:** Female Pin: 67010, 67011, 67014, 67020

**VMRS Code:** 034-003-074

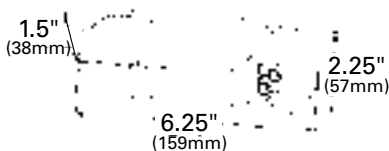

### ECONOMY OVAL DUAL-SYSTEM BACK-UP LAMP

Requires two lamps to meet back-up function • Hermetic lens-to-housing seal • Fits standard oval lamp grommets and brackets • Standard female pin termination

**62521** Clear, Female Pin

**Material:** Polycarbonate

**Regulations / Standards:** FMVSS 108 / SAE (2)R

**Finish:** Clear

**Bulb:** 1141

**Volts / Amps:** 12V / 2.1A

**Bracket:** 43362, 43952, 43220, 43222, 43223

**Grommet:** 92420, 92720

**Pigtail:** 67010, 67011, 67090

**VMRS Code:** 034-003-074



## RECTANGULAR DUAL-SYSTEM BACK-UP LAMP

Tough polycarbonate lens • Hermetic lens-to-housing seal • Requires two lamps to meet back-up function

**62381** Clear, Female Pin

**Material:** Polycarbonate

**Regulations / Standards:** FMVSS 108 / SAE (2)R

**Finish:** Clear

**Bulb:** 2057, 32 CP

**Volts / Amps:** 12V / 2.1A

**Grommet:** 94180

**Pigtail:** 67010, 67011, 67014, 67020

**VMRS Code:** 034-003-074

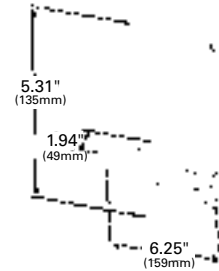

## OE-STYLE DUAL-SYSTEM BACK-UP LAMP

Requires small 1 1/16" hole for installation • Mounting pad included  
• For use on buses and trucks • Requires two lamps to meet back-up function

**62011** Gray Bezel

**62021** Chrome-Plated Bezel

**Material:** Lens - Acrylic; Housing - Steel; Bezel - ABS, Chrome-plated ABS

**Regulations / Standards:** FMVSS 108 / SAE (2)R

**Finish:** Clear / Gray

**Bulb:** 1156, 32 CP

**Volts / Amps:** 12V / 2.1A

**Pigtail:** 68080

**Lens:** Clear 90221

**VMRS Code:** 034-003-074



62011

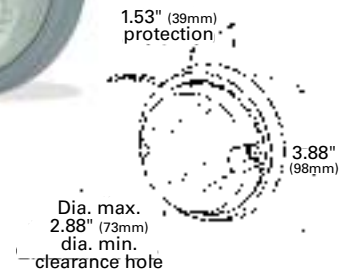

## STAINLESS STEEL RECESSED DUAL-SYSTEM BACK-UP LAMP

Snap-in lens for easy replacement • Requires two lamps to meet back-up function

**62151** Clear

**Material:** Lens - Polycarbonate; Housing - Stainless Steel

**Regulations / Standards:** FMVSS 108 / SAE (2)R

**Finish:** Clear

**Bulb:** 1156, 32 CP

**Volts / Amps:** 12V / 2.1A

**Lens:** Clear 91311, Clear 90011

**VMRS Code:** 034-003-074

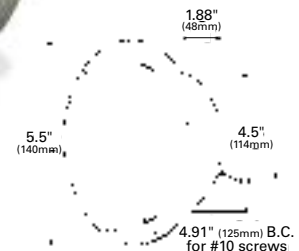



### RECTANGULAR SURFACE MOUNT DUAL-SYSTEM BACK-UP LAMP

Raised lens for maximum light output • Surface mount requires no socket hole or cutout • Requires two lamps to meet back-up function

**62291** Clear

**Material:** Lens - Polycarbonate; Housing - Steel

**Regulations / Standards:** FMVSS 108 / SAE (2)R

**Finish:** Clear

**Bulb:** 1156, 32 CP

**Volts / Amps:** 12V / 2.1A

**VMRS Code:** 034-003-074

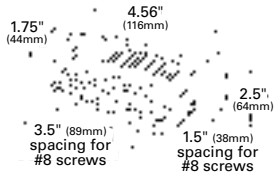

### SHALLOW DIE-CAST UTILITY LAMP

Chrome-plated die-cast housing • Shallow profile for exterior sleeper cab application • Blunt cut wires

**60311** Clear

**Material:** Lens - Acrylic; Housing - Zinc-plated Steel

**Finish:** Clear

**Bulb:** 1156, 32 CP

**Volts / Amps:** 12V / 2.1A

**Lens:** Clear 91581, Red 91582, Yellow 91583

**VMRS Code:** 034-004-068

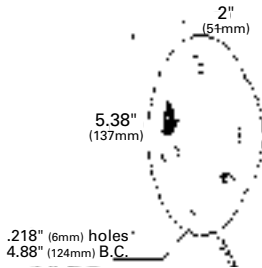

## PIGTAILS FOR 2", 2 1/2", & FEMALE PIN LAMPS

For more information on pigtail products see **Pigtails** section: page 254

### SEALED MARKER LAMP PIGTAILS

| DOUBLE SEAL: |   |
|--------------|---|
| 67001        | 6" Long, Ring Terminal Ground, Blunt Cut Wire               |
| 66850        | 6" Long, Chassis Ground                                     |
| 66851        | 6" Long, Ground Return                                      |
| SINGLE SEAL: |   |
| 66801        | 6" Long, Ground Return                                      |
| 67050        | 6" Long, Ring Terminal Ground, Blunt Cut Wire               |
| 67050-5      | 6" Long, Ring Terminal Ground, Blunt Cut Wire <b>RETAIL</b> |
| 66840        | 6" Long, Chassis Ground, Standard .180 Male                 |
| 66800        | 6" Long, Chassis Ground, Slim-Line .180 Male                |



## PIGTAILS FOR MALE PIN LAMPS

### CLEARANCE / MARKER PIGTAILS

|       |  |
|-------|--|
| 66980 | 6" Long, Chassis Ground, Slim-Line .180 Male                     |
| 66981 | 6" Long, Universal Replacement, Blunt Cut, Ring Terminal Grommet |
| 66982 | 8" Long, Ground Return   |



## PIGTAILS FOR TURTLE BACKS

### TURTLEBACK® II DOUBLE-SEAL LAMP PIGTAILS

|       |  |
|-------|--|
| 66910 | 6" Long, Chassis Ground, Slim-Line .180 Male |
| 66911 | 6" Long, Ground Return, Standard .180 Male   |
| 67070 | 2 1/2" Long, Ground Wire, Standard .180 Male |
| 67071 | Two-Wire, Standard .180 Male                 |



### STOP / TAIL / TURN THREE-WIRE 90° PLUG-IN PIGTAILS FOR MALE PIN LAMPS

|       |  |
|-------|--|
| 66816 | 6" Long, Ground Return System, 90° Plug, Slim-Line .180 Male |
|-------|--|



## PIGTAILS FOR 4" ROUND & 6" OVAL LAMPS

For more information on pigtail products see **Pigtails** section: page 254

### SINGLE FUNCTION TWO-WIRE PLUG-IN PIGTAILS FOR MALE PIN LAMPS

- 67013 11" Long, Chassis Ground, Blunt Clut Wire  
66842 10" Long, Chassis Ground, Slim-Line .180 Male



### SINGLE FUNCTION TWO-WIRE 90° PLUG-IN PIGTAILS FOR MALE PIN LAMPS

- 66846 10" Long, Chassis Ground, 90° Plug, Slim-Line .180 Male  
67016 11" Long, Chassis Ground, 90° Plug, Blunt Cut Wires



### STOP/TAIL/TURN THREE-WIRE PLUG-IN PIGTAILS FOR FEMALE PIN LAMPS

- 66812 6" Long, Chassis Ground, Slim-Line .180 Male  
67000 11 1/2" Long, Chassis Ground, Blunt Cut Wires



### STOP/TAIL/TURN THREE-WIRE 90° PLUG-IN PIGTAILS FOR FEMALE PIN LAMPS

- 66811 18" Long, Chassis Ground, Slim-Line .180 Male, Star Ring Terminal



### TWO-WIRE PLUG-IN PIGTAILS FOR FEMALE-PIN LAMPS

#### STRAIGHT:

- 67010 11 1/2" Long, Chassis Ground, Blunt Cut  
67011 10 1/4" Long, Chassis Ground, Standard .180 Male



#### 90° PLUG:

- 67014 10" Long, Chassis Ground, Blunt Cut  
67020 10" Long, Ground Return, Slim-Line .180 Male



## 3" – 5" LAMP MOUNTING

For more information on mounting products see **Mounting Options** section: page 264



### MOUNTING BRACKET FOR LARGE RECTANGULAR LAMPS

- 43780 Gray Bracket  
43783 Chrome-Plated Bracket, ABS

#### KITS:

- Material: Polycarbonate/ABS  
Finish: Gray/Chrome



### LOW PROFILE MOUNTING BRACKET

- 43850 Gray

- Material: Polycarbonate  
Finish: Gray

## LICENSE LAMP MOUNTING

For more information on mounting products see **Mounting Options** section: page 264



### LICENSE LAMP MOUNTING BRACKET

43040 White

**Material:** Polycarbonate  
**Finish:** White



### LICENSE LAMP BRACKET FOR SMALL RECTANGULAR LAMPS

42162 Black

**Material:** Polycarbonate  
**Finish:** Black



### LICENSE LAMP MOUNTING BRACKET

43830 Gray

**Material:** Polycarbonate  
**Finish:** Gray  
**Grommet:** 92520



### LICENSE LAMP MOUNTING BRACKET

43960 Gray  
43962 Black

**Material:** Polycarbonate  
**Finish:** Gray/Black

## BACK-UP LAMP MOUNTING



### RECESSED MOUNTING GROMMET FOR 4" ROUND LAMPS

91740 Grommet

**Material:** PVC  
**Finish:** Black



### SNAP-IN THEFT-RESISTANT MOUNTING FLANGE FOR 4" ROUND LED LAMPS

93552 Black  
93553 Chrome-Plated

**Material:** ABS  
**Finish:** Black/Chrome



### CLOSED BACK RECESSED MOUNTING GROMMET FOR 4" ROUND LAMPS

91950 Grommet

**Material:** PVC  
**Finish:** Black



### THEFT-RESISTANT MOUNTING FLANGE FOR 4" ROUND LAMPS

92510 White, Polycarbonate  
92512 Black, Polycarbonate  
92513 Chrome-Plated, ABS  
92511 Gray, Polycarbonate  
43253 Stainless Steel

**Material:** Polycarbonate; Stainless Steel; ABS



### STAINLESS STEEL SNAP-IN THEFT-RESISTANT MOUNTING FLANGE FOR 4" ROUND LED LAMPS

93683 Stainless Steel

**Material:** Stainless Steel  
**Finish:** Stainless Steel



### ANGLED MOUNTING BRACKET FOR 4" ROUND LAMPS

43572 Black, 90° angle bracket

**Material:** Steel  
**Finish:** Black Powder-Coated  
**Grommet:** 91740



## BACK-UP LAMP MOUNTING

For more information on mounting products see **Mounting Options** section: page 264



### MOUNTING MODULE FOR 4" ROUND LAMPS

43655 Yellow Zinc  
51090 Gray

**Material:** Steel  
**Finish:** Yellow Zinc/Gray Powder-Coated



### ANGLED MOUNTING BRACKET FOR 6" OVAL LAMPS

43362 Black, 90° angle bracket

**Material:** Steel  
**Finish:** Black  
**Grommet:** 92420



### 2-LAMP MOUNTING MODULE FOR 4" ROUND LAMPS

43642 Black, Powder-Coated

**Material:** Steel  
**Finish:** Black



### "Z" MOUNTING BRACKET FOR 6" OVAL LAMPS

43952 Black

**Material:** Steel  
**Finish:** Black  
**Grommet:** 92420



### MOUNTING MODULE FOR 4" ROUND LAMPS

43732 Black

**Material:** Steel  
**Finish:** Black



### RECESSED MOUNTING GROMMET FOR RECTANGULAR LAMPS

94180 Mounting Grommet

**Material:** PVC  
**Finish:** Black



### RECESSED MOUNTING GROMMET FOR 6" OVAL LAMPS

92420 Open Grommet  
92720 Closed Back Grommet

**Material:** PVC  
**Finish:** Black



### MOUNTING BRACKET FOR 6" OVAL LAMPS AND STROBES

43100 Black

**Material:** Steel  
**Finish:** Black  
**Grommet:** 92420



### THEFT-RESISTANT MOUNTING FLANGE FOR 6" OVAL LAMPS

43220 Gray, Polycarbonate  
43222 Black, Polycarbonate  
43223 Chrome-Plated, ABS  
43723 Stainless Steel

**Material:** Polycarbonate/Stainless Steel/ABS  
**Finish:** Gray/Black/Stainless Steel/Chrome



### THEFT-RESISTANT MOUNTING FLANGE FOR 4" ROUND LAMPS

92510 White, Polycarbonate

**Material:** Polycarbonate  
**Finish:** White

## REPLACEMENT LENSES

| LENS MODEL NUMBER | FITS LAMP      |
|-------------------|----------------|
| 90221             | 62011<br>62021 |
| 90011             | 62151          |
| 91581             | 60311          |



90221



90011



91581



### NEED HELP FINDING THE RIGHT PRODUCT?

In a world of automated phone systems and outsourced customer service it's rare to contact **REAL PEOPLE** with **REAL EXPERIENCE** providing **REAL SOLUTIONS**.

That is exactly what you get from Grote's team of expert Sales and Customer Solutions personnel.

GROTE® CUSTOMER SERVICE IS JUST A PHONE CALL AWAY | [800-628-0809](tel:800-628-0809)

# 05

## INTERIOR LIGHTING

*LUMIÈRES D'INTÉRIEUR*

*LÁMPARAS PARA INTERIOR*

# LED WHITELIGHT RECESSED-MOUNT 18" DOME LAMP



### FEATURES & BENEFITS

- Robust, one-piece, aluminum housing and removable acrylic lens
- Built-in automatic thermal protection circuit



61291

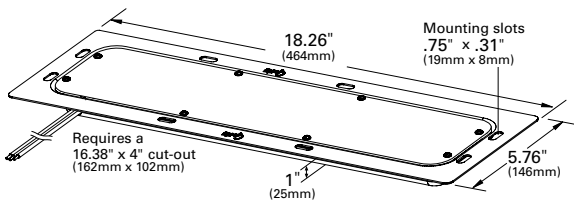

61261



61F61

| Part Number | Product Description                                 | Light Output (Usable) | Operating Temperature | Design Voltage (V) | Amp Draw (A) |
|-------------|---|-----------------------|-----------------------|--------------------|--------------|
| 61611       | High output, 18 diodes                              | 1200 Lm               | -40°F to +122°F       | 12                 | 2.16         |
| 61G21       | High output, 18 diodes, w/ motion sensor            | 1200 Lm               | -4°F to +122°F        | 12                 | 2.16         |
| 61E61       | High output, 18 diodes, dimmable                    | 1200 Lm               | -40°F to +122°F       | 12                 | 2.17/.71     |
| 61111       | High output, 16 diodes                              | 1000 Lm               | -40°F to +122°F       | 24                 | 1            |
| 61261       | Standard output, 10 diodes                          | 800 Lm                | -40°F to +122°F       | 12                 | 1.75         |
| 61F61       | Standard output, 10 diodes w/ motion sensor         | 800 Lm                | -4°F to +122°F        | 12                 | 1.75/.02     |
| 61881       | Low output, 10 diodes                               | 400 Lm                | -40°F to +122°F       | 12                 | 1.2          |
| 61291       | Standard output, 6 diodes                           | 940 Lm                | -40°F to +122°F       | 12                 | 1.7          |
| 61N11       | Standard output, bi-volt, 6 diodes w/ motion sensor | 940 Lm                | -4°F to +122°F        | 12/24              | 1.7/.85      |
| 61H91       | Standard output, 6 diodes w/ motion sensor          | 940 Lm                | -4°F to +122°F        | 12                 | 1.7/.02      |
| 61M11       | Standard output, 6 diodes PIR / interconnected      | 940 Lm                | -40°F to +122°F       | 12                 | 1.7/.02      |
| 61J11       | Standard output, 6 diodes, 4-wire, Hyundai®         | 940 Lm                | -4°F to +122°F        | 12                 | .175         |

### Accessories

| Part Number | Description      | Fits                |
|-------------|------------------|---------------------|
| 94621       | Replacement Lens | Round Corner Lenses |
| 43540       | Mounting Pan     | All 18" Dome Lamps  |

### Materials

Housing: Aluminum; Lens: Acrylic (61G21, 61F61, 61H91) Housing: Aluminum; Lens: Polycarbonate Finish: White

VMRS Code: 034-004-452

## LED WHITELIGHT RECESSED-MOUNT INTERIOR DOME LAMP



### FEATURES & BENEFITS

- LED lamp is rated to 50,000 service hours
- Fits existing similar incandescent lamp mountings
- Low heat; will not melt lens



61861



61931



61F51



82080

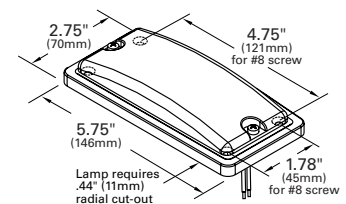
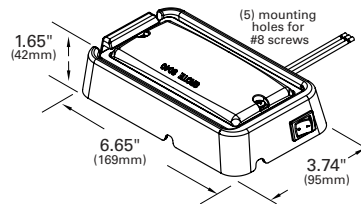
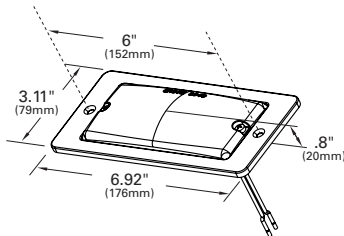

| Part Number        | Product Description  | Designation | Lighting Technology | Connection Type | Light Output (Usable) | Design Voltage (V) | Amp Draw (A)                 |
|--------------------|--|-------------|---------------------|-----------------|-----------------------|--------------------|------------------------------|
| 61861 <b>MULTI</b> | Gray Aluminum Housing, 6 Diodes                                      | Dome        | LED                 | Hardwire        | 300 Lm                | 12/24              | .3 @ 12V<br>.16 @ 24V        |
| 61991              | Gray Aluminum Housing, 6 Diodes                                      | Dome        | LED                 | Hardwire        | 300 Lm                | 12                 | 0.48                         |
| 61871 <b>MULTI</b> | Gray Aluminum Housing, 3 Diodes                                      | Courtesy    | LED                 | Hardwire        | 150 Lm                | 9-30               | .32 @ 9V<br>.094 @ 30V       |
| 61931 <b>MULTI</b> | Gray Aluminum, Flange Mount Housing, 6 Diodes                        | Dome        | LED                 | Hardwire        | 300 Lm                | 12/24              | .3 @ 12V<br>.16 @ 24V        |
| 82080 <b>MULTI</b> | Black Aluminum Housing, 3 White, 3 Red Diodes                        | Dome        | LED                 | Tyco® #770331-1 | 150 Lm                | 10-30              | .250 @ 12V<br>.140 @ 24V     |
| 61F30 <b>MULTI</b> | Black Surface Mount Plastic Housing W/ Switch, 4 White, 4 Red Diodes | Dome        | LED                 | Hardwire        | 200 Lm                | 10-32              | .250 @ 12.8V<br>.140 @ 25.6V |
| 61F51              | Black Surface Mount Plastic Housing W/ Switch, 6 White Diodes        | Dome        | LED                 | Hardwire        | 300 Lm                | 12                 | .480 @ 14V                   |
| 61031              | Gray Steel Housing   | Dome        | Incandescent        | Hardwire        | 15 CP                 | 12                 | 1.1 @ 12V                    |

### Accessories

| Part Number | Description      | Fits |
|-------------|------------------|------|
| 90401       | Replacement Lens | All  |

VMRS Code: 034-004-083 - 61031  
034-004-452 - 61861, 61991, 61871, 67931, 82080, 61F30, 61F51



## LED WHITELIGHT 4" DOME LAMP



### FEATURES & BENEFITS

- Shock-absorbing, weatherproof housing with long-life LEDs makes this a very durable lamp
- Cost-effective LED lighting option is rated at 50,000 hours
- LEDs utilize lower amp draw, putting less load on strained electrical systems
- Hardwired for easy integration into current wiring system
- Uses 70% less power than incandescent options



61E41



61H01



61171

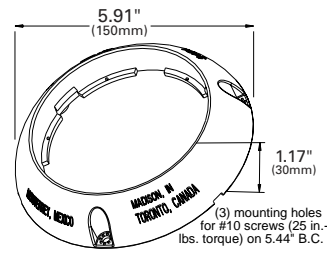

61171

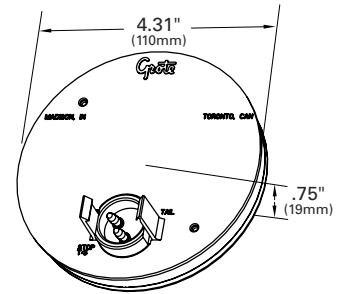

61E41

| Part Number | Product Description        | Lighting Technology | Light Output (Usable) | Connection Type         | Design Voltage (V) | Amp Draw (A) |
|-------------|----------------------------|---------------------|-----------------------|-------------------------|--------------------|--------------|
| 61H51       | 4" Integrated Flange       | LED                 | 400 Lm                | Hardwire w/2-Way Female | 12                 | .6A          |
| 61E41       | 4" Grommet Mount           | LED                 | 400 Lm                | Male Pin                | 12                 | .6A          |
| 61H01       | 4" Grommet Mount           | LED                 | 400 Lm                | Hardwire                | 12                 | .6A          |
| 61171       | 4" Surface Mount w/ Switch | LED                 | 400 Lm                | Hardwire                | 12                 | .6A          |

### Accessories

| Part Number                | Description      | Fits  |
|----------------------------|------------------|-------|
| 67013, 66842, 66846, 67016 | Male Pin Pigtail | 61E41 |

VMRS Code: 034-004-452

LED



### LED WHITELIGHT X-100 DOME LAMP

Built-in automatic thermal protection circuit • Surface mountable; versatile design means both wall or ceiling mountings are possible  
 • Fast installation with 2 self-tapping screws and no holes to cut

**61121** White

**Material:** Polycarbonate

**Finish:** Clear

**Volts / Amps:** 12V / .6A

**VMRS Code:** 034-004-452

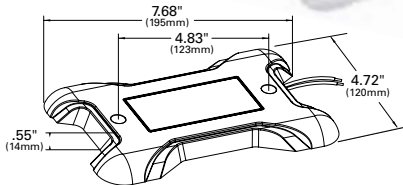

LED



### S100 LED WHITELIGHT SURFACE MOUNT DOME LAMP

Low profile sleek design, less than 15 mm height • Moisture proof construction allows for a wide variety of uses • Surface mount allows for quick and easy installation • 560 lumens of output • Operates at -40F° to +122F° • ECE R10

**61331** S100, 12V/24V w/ motion sensor



**61341** S100, 12V/24V



**Material:** Polycarbonate

**Finish:** White / Clear

**Volts / Amps:** 12V, 24V / 0.6A at 14V, 0.3A at 24V

**VMRS Code:** 034-004-452

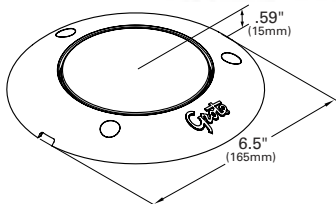

LED



### 4" ROUND FLANGE MOUNT LED DOME LAMP

Hardwire terminations allow for easy connections to the existing wiring system • Chemical resistant acrylic lens, white powder-coated housing  
 • Operates at a wide temperature range, from -40°F to +122°F

**61141** White

**Material:** Aluminum / Acrylic

**Finish:** Clear

**Volts / Amps:** 12V / .48A

**VMRS Code:** 034-004-452

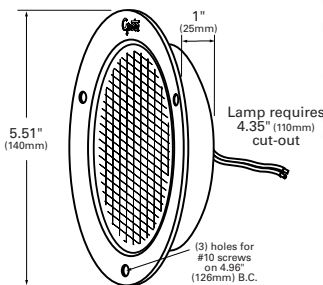

LED



### LED COMPARTMENT LAMP

Shock and Vibration Proof • 50,000 hours of service life • Can be Recess or Surface Mounted • For Interior Use Only

**61851** Clear, Push Lens for On/Off

**61851-5** Clear, Push Lens for On/Off



**Material:** Polycarbonate

**Finish:** black

**Volts / Amps:** 12V

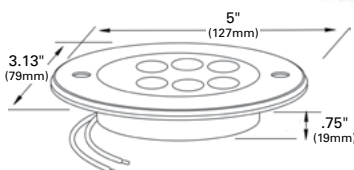

### TORSION MOUNT® II 4" ROUND DOME LAMP

Gel-Mount® bulb cradle design • O-ring seal pigtail design eliminates corrosion • Locking tabs ensure secure pigtail connection • Hermetic lens-to-housing seal

- 61451** Clear, Male Pin
- 61051** Clear, Female Pin

**Material:** Polycarbonate  
**Finish:** Clear  
**Bulb:** 15 CP  
**Volts / Amps:** 12V / 1.04A  
**Bracket:** 43572, 43253, 92510, 92512, 92513  
**Grommet:** 91740, 91950  
**Pigtail:** Male Pin: 67013, 66842, 66846, 67016;  
 Female Pin: 67010, 67011, 67020, 67014  
**VMRS Code:** 034-004-083

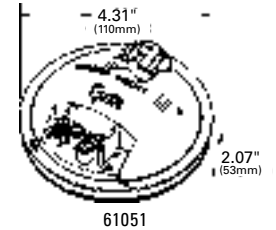
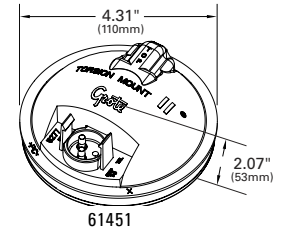

### ROUND DOME LAMP WITH SWITCH

Surface mount lamp • Design resists corrosion and lens shattering due to heat build-up • Low profile to protect against knock-off by load or personnel

- 61161** White Base
- 61091** Chrome Base

**Material:** Polycarbonate  
**Finish:** Clear  
**Bulb:** 93, 15 CP  
**Volts / Amps:** 12V / 1.04A  
**Pigtail:** 68170  
**Lens:** White 91101  
**VMRS Code:** 034-004-083



61091

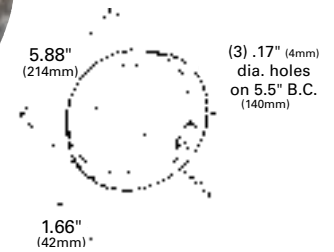

### 6" SURFACE MOUNT DOME LAMP WITH SWITCH

Perfect for use as a compartment lamp • Popular lamp for bus and RV applications • Separate ground wire • Not suitable for use in headliners or confined spaces • Push button

- 61821** Clear

**Material:** Aluminum  
**Finish:** Clear  
**Bulb:** 1141, 21 CP  
**Volts / Amps:** 12V / 1.44A  
**VMRS Code:** 034-004-083

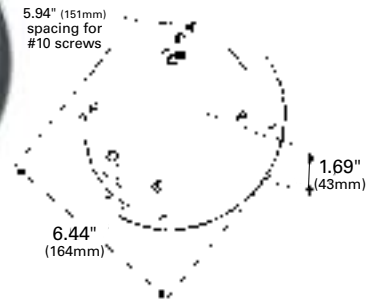

### LED WHITELIGHT 7" ROUND DOME LAMP

High-output white LED dome lamp • Encapsulant potting for total circuit board protection against moisture and corrosion • Designed to operate in extreme-cold temperatures down to -40°F • Shallow recess requires only 1 1/4" depth for mounting pan • Self-resetting cut-off feature to protect against excess heat

- 61811** Clear

**Material:** Powder-Coated Steel / Acrylic  
**Finish:** White / Clear  
**Volts / Amps:** 12V / 1.92A  
**VMRS Code:** 034-004-452

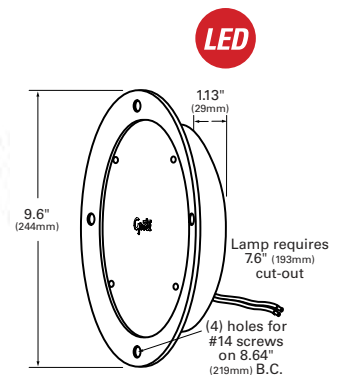

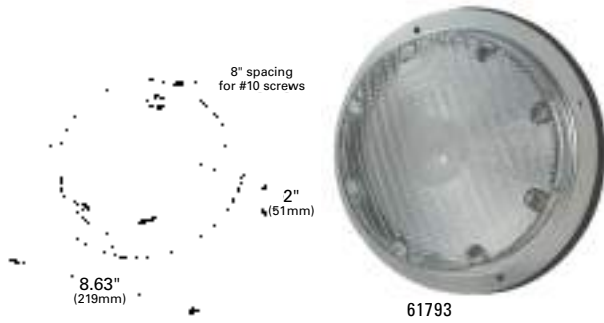

## 8" SURFACE MOUNT DOME LAMP

7" diameter lens • Separate ground wire • Popular for use as a "scare" lamp on RVs • Not suitable for use in headliners or confined spaces

**61793** Clear, Stainless Steel Housing

**Material:** Steel  
**Finish:** Stainless / White / Clear Lens  
**Bulb:** 1156, 32 CP  
**Volts / Amps:** 12V / 2.1A  
**VMRS Code:** 034-004-083

LED

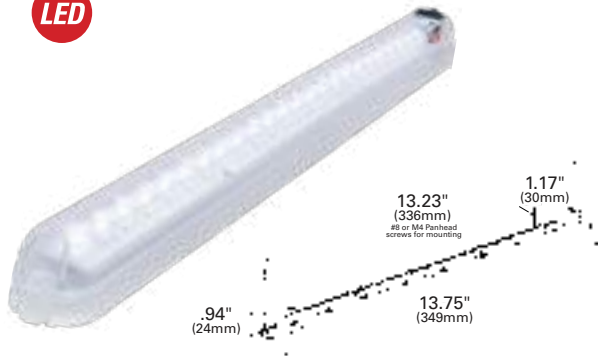

## LED SLIMLITE COURTESY LAMP

Lamp features a low profile less than one inch • High efficiency lamp uses little power and generates minimal heat • Excellent option for cabinet lighting and other interior uses

**60581** Clear  
**60591** Clear, w/ Switch

**Material:** Polycarbonate  
**Finish:** Clear  
**Volts / Amps:** 12V / .4A  
**VMRS Code:** 034-004-068

LED

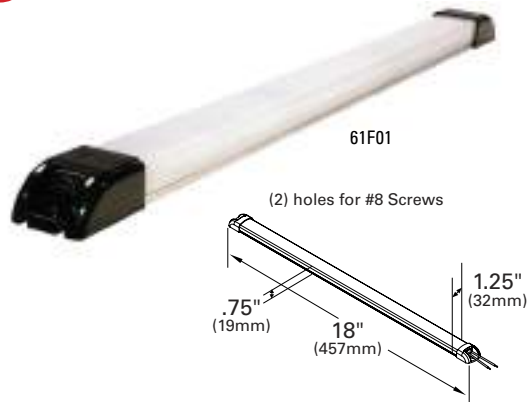

## LED SLIMWHITE

High-output 500-lumen LED dome lamp emits low heat • Tough polycarbonate lens • Sturdy aluminum base • Profile is less than 3/4" high • Rated at 50,000 service hours • 61G01 multi-function, illuminate all, outer segments, or middle segment

### 18" LENGTH

**61E81** 500 Lm, Frosted  
**61E91** 500 Lm, Frosted   
**61F01** 500 Lm, Frosted, w/ Switch

### 48" LENGTH

**61281** 1500 Lm, Frosted  
**61G01** 2100 Lm, Clear, Multifunction

**Material:** Polycarbonate/ Aluminum  
**Finish:** White  
**Volts / Amps:** 18" 12V / .6A; 24V / .3A  
 48" 12V / 1.2A  
**VMRS Code:** 034-004-068

LED

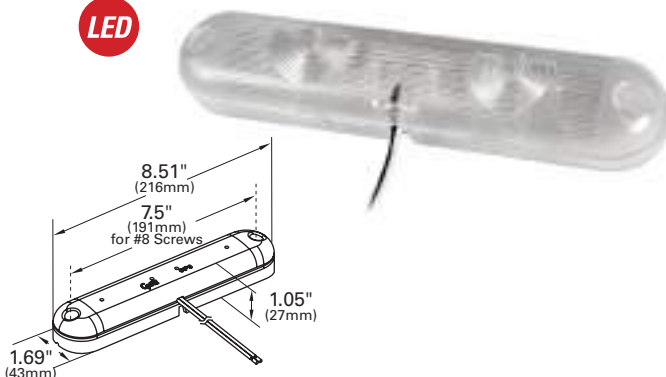

## LED CABINET/COMPARTMENT DOME LAMP

Self-resetting cut-off switch to protect against excess current • Designed to operate in extreme cold temperatures down to -40°F • Encapsulant potting for total circuit board protection against moisture and corrosion • Optic lens design focuses light downward/upward based on orientation

**61F81** Clear

**Material:** Polycarbonate  
**Regulations / Standards:** SAE J575™  
**Finish:** Clear  
**Volts / Amps:** 12V / .35A  
**VMRS Code:** 034-004-452

### OVAL LED WHITELIGHT DOME LAMP

Grote® LEDs provide valuable light output with low amp draw  
 • Cost-effective LED lighting option is rated at 50,000 hours

**61G31** Clear, Male Pin

**Material:** ABS / Acrylic  
**Standards:** SAE J2139™  
**Finish:** Clear  
**Volts / Amps:** 12.8V / .6A  
**Bracket:** (requires grommet or flange): 43362, 43952  
**Flange:** 43220, 43223, 43222, 43723, 42153  
**Grommet:** 92420, 92720  
**Pigtail:** 67013, 66842, 66846, 67016  
**VMRS Code:** 034-004-452



### EUROSTYLE MAP & DOME LAMP

Three-way switch: map only, dome/map light, or off • Two options for wiring: either for dome to light or not to light, when door is open

**61301** Clear

**Material:** Nylon / Polycarbonate  
**Finish:** Black  
**Volts / Amps:** Bulb: Dome - 561, 12 C.P.: 12 V / .97A; Bulb: Map - 1816, 3 C.P.: 12V / .33A  
**VMRS Code:** 034-004-083

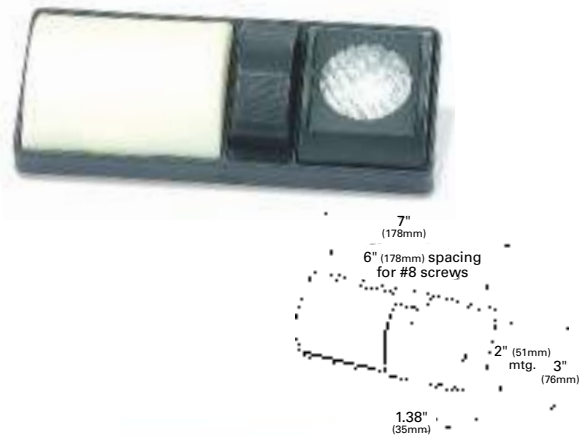

### SQUARE DOME LAMP WITH SWITCH

Three-position switch enables variable intensity: low-6 CP, high-21 CP, or off  
 • Surface mount • Large enough to cover most existing holes

**61221** Clear

**Material:** ABS/Polycarbonate  
**Finish:** Clear  
**Volts / Amps:** Bulb: 1016, 21/6 CP: 12V / 1.5A max  
**VMRS Code:** 034-004-083

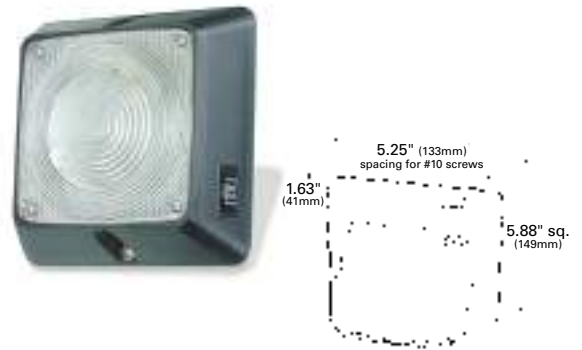

### DOMELAMP WITH SWITCH

Durable polycarbonate lens • Integrated on/off toggle switch • Raised lens for maximum light dispersion • Comes with ground wire

**61491-5** Clear **RETAIL**

**Material:** Steel / Polycarbonate  
**Finish:** Clear  
**Volts / Amps:** Bulb: 1156, 32 CP: 12V / 2.1A  
**VMRS Code:** 034-004-083

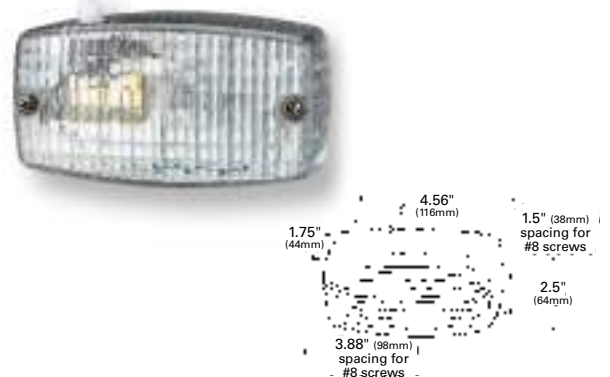



LED

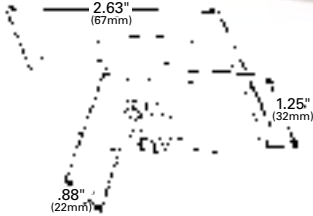

### SMALL RECTANGULAR LED UTILITY LAMP

Long-life LED light source makes this lamp the perfect choice for difficult-to-reach mounting locations • Uses same UBS pigtailed as incandescent for a quick Plug-and-Go® retrofit

**60421** Clear

**Material:** Polycarbonate  
**Finish:** Clear  
**Volts / Amps:** 12V / .2A  
**Bracket:** 43380, 43970, 43980  
**Pigtail:** 66850, 67050, 67001, 66851, 66800, 66840  
**Grommet:** 91380  
**VMRS Code:** 034-004-068

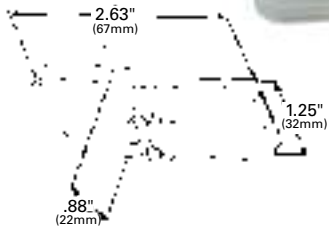

### SMALL RECTANGULAR UTILITY LAMP

Sonically sealed lens • Single 15,000-hour bulb

**60271** Clear

**Material:** Polycarbonate  
**Finish:** Clear  
**Bulb:** 2 CP  
**Volts / Amps:** 12V / .33A  
**Bracket:** 43380, 43970, 43980  
**Pigtail:** 66850, 67050, 67001, 66851, 66800, 66840  
**Grommet:** 91380  
**VMRS Code:** 034-002-068

LED

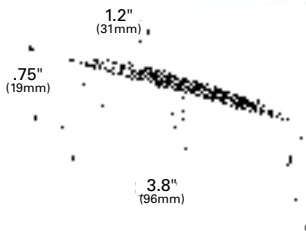

### RECTANGULAR LED UTILITY LAMP

Long-life LED light source makes this lamp the perfect choice for difficult-to-reach mounting locations • Uses same UBS pigtailed as incandescent for a quick Plug-and-Go® retrofit • Hermetic lens-to-housing seal

**60411** Clear

**Material:** Polycarbonate  
**Finish:** Clear  
**Volts / Amps:** 12V / .2A  
**Bracket:** 43780, 43783, 43390, 43790, 43850  
**Pigtail:** 66982, 66980, 66981  
**VMRS Code:** 034-004-068

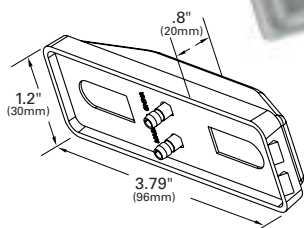

### RECTANGULAR UTILITY LAMP

Sonically sealed, rectangular double-bulb lamp • Designed for narrow mounting applications • 15,000-hour bulbs

**60301** Clear

**Material:** Polycarbonate  
**Finish:** Clear  
**Bulb:** 2 CP  
**Volts / Amps:** 12V / .66A  
**Bracket:** 43390, 43780, 43790, 43850, 43783  
**Pigtail:** 66981, 66982  
**VMRS Code:** 034-004-068

## 2" LED INTERIOR COURTESY LAMP

Bright, single LED provides ample light for tool boxes, cabinets, and other hard-to-light areas • Encapsulant potting for total circuit board protection against vibration and corrosion

**60561** White

**Material:** Polycarbonate

**Finish:** Clear

**Volts / Amps:** 14V / .2A

**Bracket:** 43690, 43150, 43152, 43153, 43532

**Grommet:** 92120, 92150, 94100

**Pigtail:** 66851, 66850, 66840, 67001, 67050, 66801

**VMRS Code:** 034-004-068

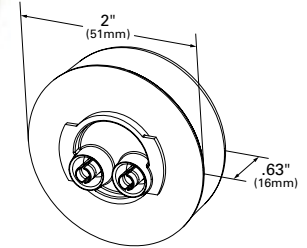

## TWO-BULB SQUARE CORNER UTILITY LAMP

Ideal courtesy or dome lamp • Attached pigtail with two stainless steel grounds

**46791** Clear

**Material:** Polypropylene / Polycarbonate

**Finish:** Clear

**Bulb:** 1893 (2), 2 CP

**Volts / Amps:** 12V / .66A

**Pigtail:** 67120

**Lens:** 91961

**VMRS Code:** 034-004-068

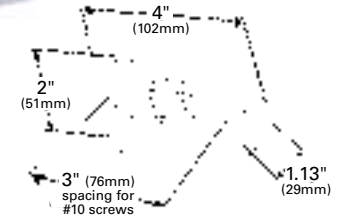

## 2 1/2" ROUND UTILITY LAMP

Ideal for utility, courtesy or dome applications • Hermetic lens-to-housing seal • 15,000-hour bulb • Twist-on mounting

**45811** Clear

**Material:** Polycarbonate

**Finish:** Clear

**Bulb:** 2 CP

**Volts / Amps:** 12V / .33A

**Bracket:** 43690, 43160, 43163, 43512, 43522

**Grommet:** 91880, 91890, 91400, 91410, 92070

**Pigtail:** 66851, 66850, 67001, 67050, 66801, 66800, 66840

**VMRS Code:** 034-004-068

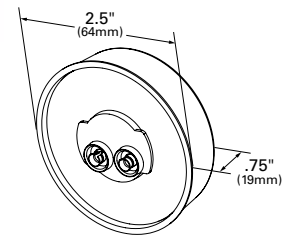

## STEPWELL UTILITY LAMP

Rugged, heavy-duty design • Brilliant chrome finish • Easy to install • Includes foam mounting pad

**60351** Clear

**Material:** Die-cast / Polycarbonate

**Regulations / Standards:** FMVSS 108 / SAE L

**Finish:** Chrome

**Bulb:** 906, 6 CP

**Volts / Amps:** 12V / .7A

**VMRS Code:** 034-002-122

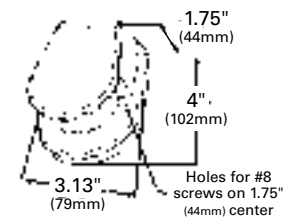

LED

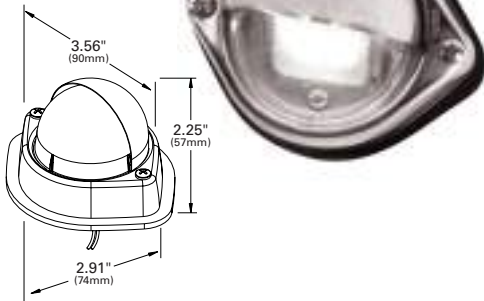
**LED COURTESY STEPWELL LAMP**

Same mounting as popular incandescent versions • Designed to integrate into existing bus electronic platforms • ADA-compliant

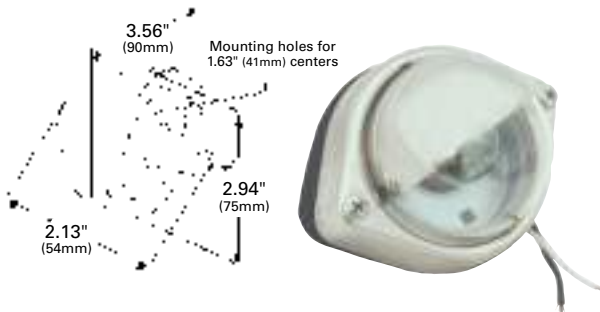
**60571** White**Material:** Stainless Steel / Polycarbonate**Finish:** Stainless**Volts / Amps:** 14V / .3A**Lens:** 93201**VMRS Code:** 034-004-256**COURTESY STEPWELL LAMP**

Bright, polished stainless steel construction • High-heat and impact-resistant lens • Adjustable hood for directional lighting • Bulb replaceable • Mounting pad and screws included

**60361** Clear**Material:** Stainless Steel / Polycarbonate**Finish:** Stainless**Bulb:** 1142, 21 CP**Volts / Amps:** 12V / 1.34A**VMRS Code:** 034-004-122

LED

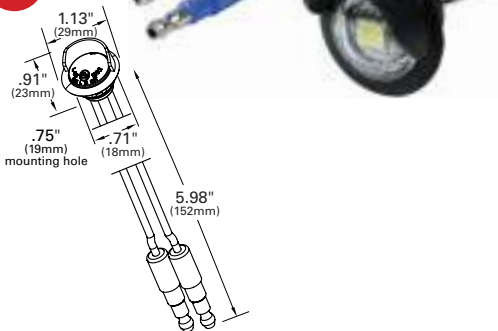
**MICRONOVA® DOT LED COURTESY STEPWELL LAMP**

Durable one-piece LED lamp design • Hardwire with .180 slim-line UBS plug connections for maximum performance

**60721** Lamp with Hooded Grommet**Material:** Polycarbonate / PVC**Regulations / Standards:** FMVSS 108 / SAE L**Finish:** Clear/Black**Volts / Amps:** 9-32V / .03A**Grommets:** 94360**VMRS Code:** 034-004-256

LED

**HI COUNT® LED COURTESY LAMP**

Mounts using two #6 screws • Longer life than incandescent; uses LED technology to reduce maintenance costs

**G6261** Chrome-Plated Steel**G6261-5** Chrome-Plated Steel **RETAIL****Material:** Chrome-Plated Steel**Finish:** Chrome**Volts / Amps:** 12V / .02A**VMRS Code:** 034-004-068

### COURTESY LAMP

Chrome-plated steel housing • Single-bulb unit similar to lamps on Chevrolet®/GM® vehicles

**60251** Clear  
**60251-5** Clear **RETAIL**

**Material:** Steel  
**Finish:** Chrome  
**Bulb:** 67, 4 CP  
**Volts / Amps:** 12V / .59A  
**VMRS Code:** 034-004-068



### LED COMPACT COURTESY LAMP

Fits 1 1/4" hole in panels from 1/16" to 1/8" thick • Rubber-sealed spring and pigtail assembly • Translucent white plastic lens with chrome shade

**G6121** Clear  
**G6121-5** Clear **RETAIL**

**Material:** Steel  
**Finish:** Chrome  
**Volts / Amps:** 12V / .02A  
**VMRS Code:** 034-004-068



### COMPACT COURTESY LAMP

Fits 1 1/4" hole in panels from 1/16" to 1/8" thick • Rubber-sealed spring and pigtail assembly • Translucent white plastic lens with chrome shade • Chassis ground

**60101** Clear  
**60101-5** Clear **RETAIL**

**Material:** Steel  
**Finish:** Chrome  
**Bulb:** 67, 4 CP  
**Volts / Amps:** 12V / .59A  
**Accessory:** Socket Wire: 84-1003  
**VMRS Code:** 034-004-068

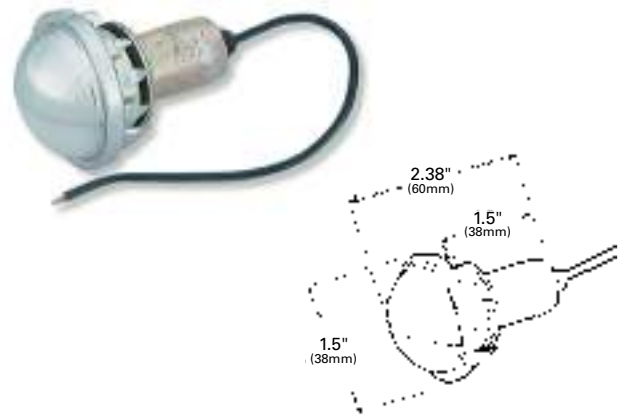

### LED COURTESY LAMP

Illuminates instrument panel and compartments • Clear plastic lens

**G6131** Clear  
**G6131-5** Clear **RETAIL**

**Material:** Steel  
**Finish:** Chrome  
**Volts / Amps:** 12V / .002A  
**VMRS Code:** 034-004-068

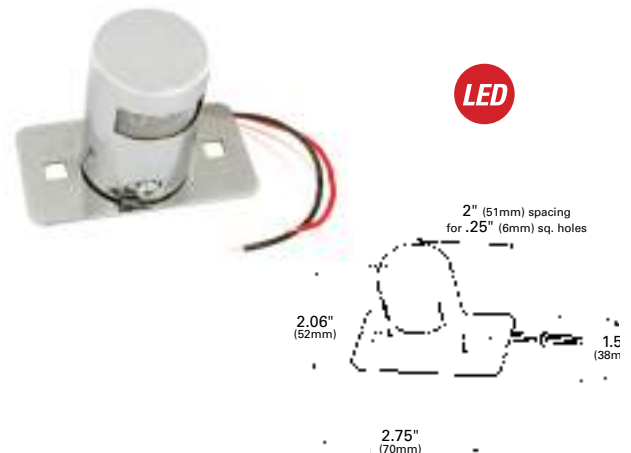

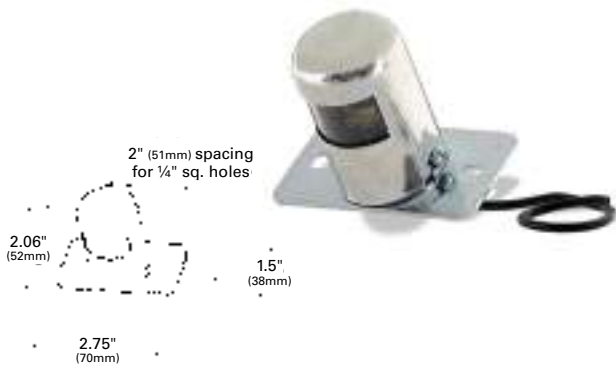
**ECONOMY COURTESY LAMP**

Illuminates instrument panel and compartments • Clear plastic lens  
• Chassis ground

**60151** Clear  
**60151-5** Clear **RETAIL**

**Material:** Steel  
**Finish:** Polished Chrome  
**Bulb:** 67, 4 CP  
**Volts / Amps:** 12V / .59A  
**Pigtail:** 68080  
**VMRS Code:** 034-004-068

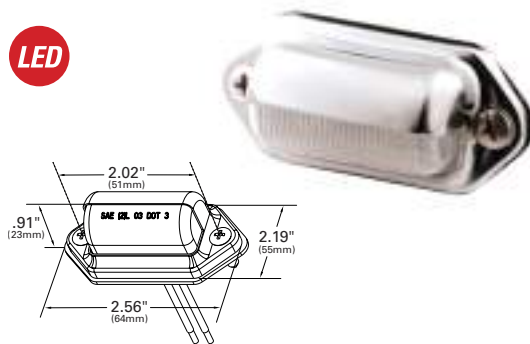
**LED****HI COUNT® INTERIOR/UTILITY LAMP**

LED offering provides maximum lighting output in tight spaces • Low power consumption and heat production • Hooded guard to reduce glare

**G6151** Clear  
**G6151-5** Clear **RETAIL**

**Material:** Steel / Polycarbonate  
**Finish:** Chrome  
**Volts / Amps:** 12V / .025A  
**VMRS Code:** 034-004-068

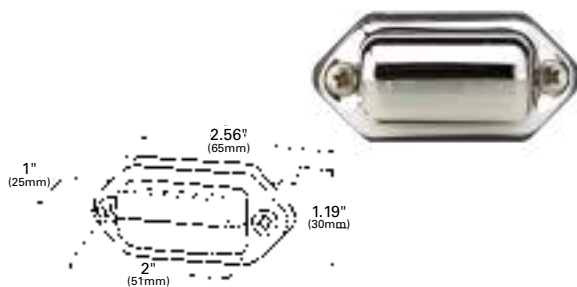
**INTERIOR/UTILITY LAMP**

Chrome-plated housing • Hooded guard to reduce glare • Separate ground wire

**61501** Clear  
**61501-5** Clear **RETAIL**

**Material:** Brass / Polycarbonate  
**Finish:** Chrome  
**Bulb:** 194, 2 CP  
**Volts / Amps:** 12V / .27A  
**VMRS Code:** 034-004-068

**LED****LED ROPE LIGHTING**

Flexible rope lighting is perfect for compartments and tool boxes  
• 50' roll comes with 10 wire connectors, 50 mounting clips and 10 end caps • 1/2" diameter rope • LEDs spaced one per inch

**60481** White

**Finish:** Clear  
**Volts / Amps:** 12V / .07A per foot  
**VMRS Code:** 034-004-068



## AUTOMATIC ELECTRONIC DOME LIGHT SWITCH WITH TIMER

Reduces the overall number of components of an interior lighting system

- Eliminates tapping into the air brake delivery system
- Automatic shut down of circuit for no-fuss on/off
- Allows for multiple, simple ground-sensing switches while maintaining the integrity of the interior lighting system
- Timer is factory pre-set for 40 minutes on-time and can be manually shut off or automatically when the vehicle experiences forward/backward acceleration
- Operates at -40C° to +85C°
- Four-wire design
- Designed to replace Grote® part number 44360

### 44440 Dome Lamp Switch

**Material:** Nylon / G.F., UL94HB / Polycarbonate

**Standards:** SAE J1455™, J2139™, IP65

**Finish:** Gray

**Volts / Amps:** 9–16V / 15A max load

**VMRS Code:** 034-004-014

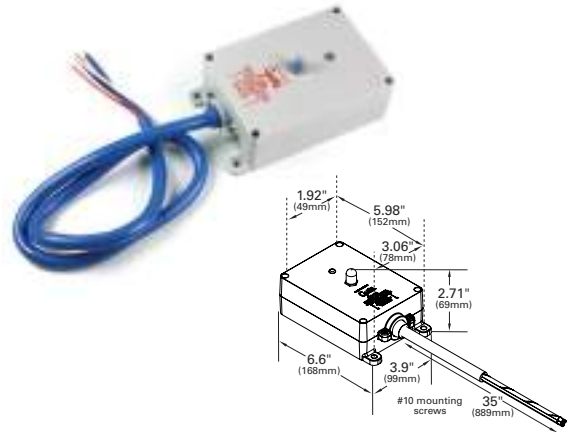

## ELECTRONIC DOME LAMP SWITCH

Solid-state electronic circuitry

- Impact resistant PVC construction
- Sealed trigger switch
- High current-switching capacity of 30 amps, not to exceed 15 operating amps
- Wide voltage range: 9 to 16 volts
- Three-wire design
- Designed to replace Grote® part number 44240

### 44910 Full Feature, Surface Mount **MULTI**

**Material:** PVC

**Standards:** IP65

**Finish:** Gray

**Volts / Amps:** 9–14V / .9A max

**Accessory:** Automotive style 15A fuse

**VMRS Code:** 034-004-014

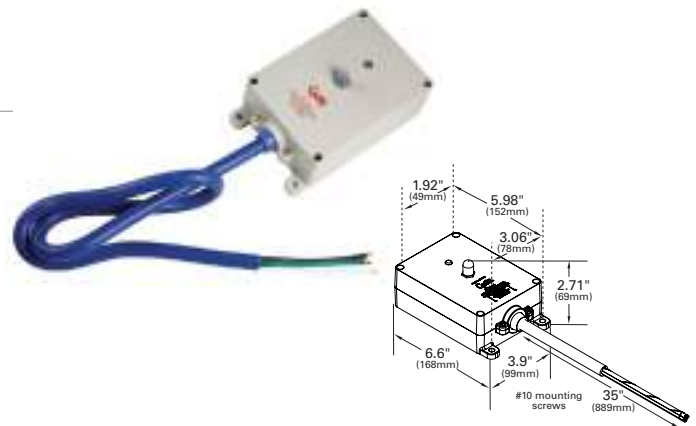

## RECESSED MOMENTARY GROUND SWITCH

Simple switch to reset the timer function of standard "outside-the-trailer" switches

- Recessed into the trailer wall to eliminate bumps and knock-offs
- Easy to integrate into the current system
- For use with 44360, 44440 and 44190 switches

### 44380 Switch

**Material:** ABS

**Standards:** SAE J575e™ 1970

**Finish:** White

**Volts:** .02V–30V (D.C)

**VMRS Code:** 034-004-093



## ECONOMY FULL-FEATURE TIMER SWITCH

Solid-state, low profile design

- Two-hour timer
- Fully potted for protection against moisture
- 5-amp, field-replaceable blade fuse

### 44242 Switch

**Material:** Polycarbonate

**Finish:** Gray

**Volts:** 10–14V

**VMRS Code:** 034-004-093

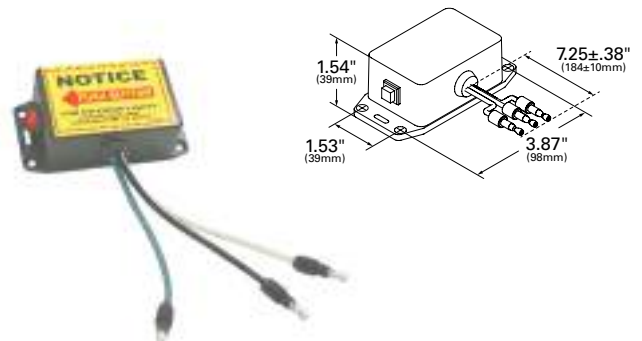

## FEMALE PIN CLEARANCE MARKER PIGTAILS

For more information on pigtail products see **Pigtails** section: page 254

### SEALED MARKER LAMP PIGTAILS

#### DOUBLE SEAL:

- 67001** 6" Long, Ring Terminal Ground, Blunt Cut Wire
- 66850** 6" Long, Chassis Ground
- 66851** 6" Long, Ground Return

#### SINGLE SEAL:

- 66801** 6" Long, Ground Return
- 67050** 6" Long, Ring Terminal Ground, Blunt Cut Wire
- 67050-5** 6" Long, Ring Terminal Ground, Blunt Cut Wire **RETAIL**
- 66840** 6" Long, Chassis Ground, Standard .180 Male
- 66800** 6" Long, Chassis Ground, Slim-Line .180 Male



## 2 PIN, MALE PIN CLEARANCE MARKER PIGTAILS

### CLEARANCE / MARKER PIGTAILS

- 66980** 6" Long, Chassis Ground, Slim-Line .180 Male
- 66981** 6" Long, Universal Replacement, Blunt Cut, Ring Terminal Grommet
- 66982** 8" Long, Ground Return



## PIGTAILS FOR 4" ROUND & 6" OVAL LAMPS

### SINGLE FUNCTION TWO-WIRE PLUG-IN PIGTAILS FOR MALE PIN LAMPS

- 67013** 11" Long, Chassis Ground, Blunt Cut Wire
- 66842** 10" Long, Chassis Ground, Slim-Line .180 Male



### SINGLE FUNCTION TWO-WIRE 90° PLUG-IN PIGTAILS FOR MALE PIN LAMPS

- 66846** 10" Long, Chassis Ground, 90° Plug, Slim-Line .180 Male
- 67016** 11" Long, Chassis Ground, 90° Plug, Blunt Cut Wires



### TWO-WIRE PLUG-IN PIGTAILS FOR FEMALE-PIN LAMPS

#### STRAIGHT:

- 67010** 11 1/2" Long, Chassis Ground, Blunt Cut
- 67011** 10 1/4" Long, Chassis Ground, Standard .180 Male

#### 90° PLUG:

- 67014** 10" Long, Chassis Ground, Blunt Cut
- 67020** 10" Long, Ground Return, Slim-Line .180 Male



## PIGTAILS

For more information on pigtail products see **Pigtails** section: page 254

### MARKER LAMP PIGTAIL

67120 7 3/4" Long, .180 Slim-Line Male



67120

### REPLACEMENT LAMP SOCKET PIGTAILS

68170 9 1/2" Long Single Contact



68170

## 3" LAMP MOUNTING

For more information on mounting products see **Mounting Options** section: page 264



### GROMMET FOR SMALL RECTANGULAR LAMPS

91380 Black

Material: PVC  
Finish: Black



### HEADER-MOUNT BRACKET FOR SMALL RECTANGULAR LAMPS

KITS:

43380 White (42141 + 67050)

Material: Polycarbonate  
Finish: White



### BRACKET KITS FOR SMALL RECTANGULAR LAMPS

43970 Gray (+ 67050 pigtail)

43980 Chrome-Plated (+ 67050 pigtail)



Material: Polycarbonate/ABS  
Finish: Chrome/Gray

## 3" – 5" LAMP MOUNTING



### MOUNTING BRACKET FOR LARGE RECTANGULAR LAMPS

43780 Gray Bracket

43783 Chrome-Plated Bracket, ABS

KITS:

43390 Gray (43780 + 66981)

43790 Gray (43780 + 66980)

Material: Polycarbonate/ABS  
Finish: Gray/Chrome



### LOW PROFILE MOUNTING BRACKET

43850 Gray

Material: Polycarbonate  
Finish: Gray

## 2" & 2½" LAMP MOUNTING

For more information on mounting products see **Mounting Options** section: page 264



### RECESSED MOUNTING GROMMET FOR 2" ROUND LAMPS

- 92120 Open Grommet  
92150 Closed Back Grommet

#### KITS:

- 94100 Open Grommet (92120 + 67050)

**Material:** PVC  
**Finish:** Black



### THEFT-RESISTANT MOUNTING FLANGE FOR 2" ROUND LAMPS

- 43150 Gray, Polycarbonate  
43152 Black, Polycarbonate  
43153 Chrome-Plated, ABS

**Material:** Polycarbonate/ABS  
**Finish:** Gray/Black/Chrome



### RECESSED MOUNTING GROMMET FOR 2½" ROUND LAMPS

- 91400 Open Grommet  
92070 Closed Back Grommet

**Material:** PVC  
**Finish:** Black



### THEFT-RESISTANT MOUNTING FLANGE FOR 2½" ROUND LAMPS

- 43160 Gray, Polycarbonate  
43163 Chrome-Plated, ABS

**Material:** Polycarbonate/ABS  
**Finish:** Gray/Chrome



### RECESSED MOUNTING GROMMET FOR 2½" ROUND LAMPS

- 91410 Open Grommet

**Material:** PVC  
**Finish:** Black



### 90° ANGLE MOUNTING BRACKET FOR 2" AND 2½" ROUND LAMPS

#### FOR 2 1/2" LAMPS:

- 43512 Accommodates 94010, 91400, 92070 Grommets (2 25/32" Hole)  
43522 Accommodates 94000, 91410 Grommets (3" Hole)

#### FOR 2" LAMPS:

- 43532 Accommodates 94100, 92120, and 92150 Grommets (2 5/16" Hole)

**Material:** Steel  
**Finish:** Black Enamel



### 45° ANGLED BEVELED-EDGE RECESSED MOUNTING GROMMET FOR 2½" ROUND LAMPS

- 91880 Open Grommet

**Material:** PVC  
**Finish:** Black



### TWIST-IN SURFACE MOUNT BRACKET FOR 2" AND 2½" ROUND LAMPS

- 43690 Gray

**Material:** Polycarbonate  
**Finish:** Gray



### SURFACE MOUNT GROMMET FOR 2½" ROUND LAMPS

- 91890 Open Grommet

**Material:** PVC  
**Finish:** Black

## MICRONOVA® LAMP MOUNTING



### HOODED MICRONOVA® DOT GROMMET

- 94360 Black

**Material:** PVC  
**Finish:** Black

## 4" LAMP MOUNTING

For more information on mounting products see **Mounting Options** section: page 264



### RECESSED MOUNTING GROMMET FOR 4" ROUND LAMPS

91740 Grommet

**Material:** PVC  
**Finish:** Black



### THEFT-RESISTANT MOUNTING FLANGE FOR 4" ROUND LAMPS

92510 White, Polycarbonate  
92512 Black, Polycarbonate  
92513 Chrome-Plated, ABS  
92511 Gray, Polycarbonate  
43253 Stainless Steel

**Material:** Polycarbonate; Stainless Steel; ABS



### ANGLED MOUNTING BRACKET FOR 4" ROUND LAMPS

43572 Black, 90° angle bracket

**Material:** Steel  
**Finish:** Black Powder-Coated  
**Grommet:** 91740

## 6" LAMP MOUNTING



### RECESSED MOUNTING GROMMET FOR 6" OVAL LAMPS

92420 Open Grommet  
92720 Closed Back Grommet

**Material:** PVC  
**Finish:** Black



### "Z" MOUNTING BRACKET FOR 6" OVAL LAMPS

43952 Black

**Material:** Steel  
**Finish:** Black  
**Grommet:** 92420



### ANGLED MOUNTING BRACKET FOR 6" OVAL LAMPS

43362 Black, 90° angle bracket

**Material:** Steel  
**Finish:** Black  
**Grommet:** 92420

## REPLACEMENT LENSES

| LENS MODEL NUMBER | FITS LAMP |
|-------------------|-----------|
| 90401             | 61031     |
|                   | 61861     |
|                   | 61991     |
|                   | 61871     |
|                   | 61931     |
| 91961             | 46791     |



90401



91961

GM® is a registered trademark of General Motors LLC; Chevrolet® is a registered trademark of General Motors LLC. Hyundai® is a registered trademark of HYUNDAI MOTOR COMPANY; Tyco® is a registered trademark of Tyco International Services GmbH LIMITED LIABILITY COMPANY SWITZERLAND;

All product and company names are trademarks™ or registered® trademarks of their respective holders. Use of them does not imply any affiliation with or endorsement by them.



**06**

---

**XTL®  
FOR APPLICATIONS  
AND CREATIVITY**

---

***XTL® POUR APPLICATIONS  
ET CRÉATIVITÉ***

---

***XTL® PARA APLICACIONES  
Y CREATIVIDAD***

---



## XTL® TRUCK BUNDLES

### FEATURES & BENEFITS

- Use the XTL® Xtreme Truck Bundle to light up your pick-up truck, SUV, RV, utility trailer—any place where light is needed and power is not readily available
- Connected to a battery box, XTL® will provide light for at least 35 hours on a fresh set of batteries
- Expandable kit allows the user to connect to 12V power and add (3) strips of different lengths and light output
- Grote® UBS wire harness uses sealed connections and includes a professional installation kit



**VISIT [GROTE.COM/XTL](http://GROTE.COM/XTL)  
 FOR COMPLETE PRODUCT LINE INFORMATION**

## ***XTL® FOR ATV AND UTV***



### ***XTL® REAR VISIBILITY KIT***

Add an additional layer of visibility with the durable, flexible XTL® strip on your UTV or Side by Side. This XTL® kit features the bright, red strip, OEM mounting tape and wire harness.



### ***XTL® TASK LIGHT KIT***

Off-road or on the jobsite, easy-to-install and ultra-durable Grote® XTL® enables you to put light anywhere you need it.





## XTL® EXTRUSIONS



### FEATURES & BENEFITS

- Provides ability to install extrusion at 90° angle to be able to aim light at a 45° angle
- Opaque lens provides a smooth, non-glaring light output
- Extrusions protect XTL® Strip Lighting from impacts
- Snap-in or slide-in lens
- Mounting lips supplied separately in hardware bag
- Recommendation: use 2 clips on 288mm extrusion, 3 clips on 488mm extrusion, 4 clips on 576mm extrusion, and 5 clips on 864mm extrusion
- 18-8 stainless-steel Phillips flathead screws required for installation (not included)



Opaque Lens Angle



Opaque Lens Flat

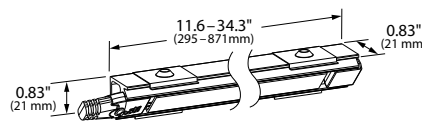
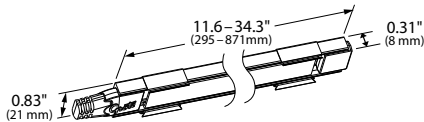

**VISIT GROTE.COM/XTL  
 FOR COMPLETE PRODUCT LINE INFORMATION**

## **XTL® COLORED AND WHITE STRIPS**



### **FEATURES & BENEFITS**

- Made in the U.S.A.
- Long-life LED performance and reliability
- Strips are less than .5 mm thick
- Lightweight
- Flexible – can bend to a 0.5" radius and conform to compound curves
- Concussion- and abrasion-resistant
- 3-year warranty
- Comes with 3M® VHB tape for long-term (10-year-plus) adhesion

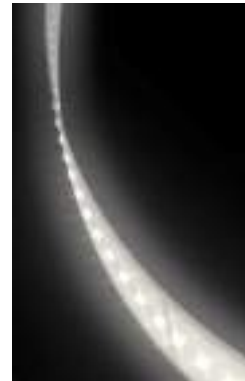

3M® is a registered trademark of 3M Company;

All product and company names are trademarks™ or registered® trademarks of their respective holders. Use of them does not imply any affiliation with or endorsement by them.





**REVOLUTIONARY LED AUXILIARY VEHICLE LIGHTING**

Create special lighting effects for virtually any vehicle with XTL®, a family of flexible, lightweight, ultra-thin LED lighting strips. Available in a range of colors, durable XTL® strips can twist and conform to most surfaces to provide direct or indirect light.



**VISIT [GROTE.COM/XTL](http://GROTE.COM/XTL)  
FOR COMPLETE PRODUCT LINE INFORMATION**

# 07

## FORWARD LIGHTING

*PHARES UTILITAIRES*

*FAROS DELANTEROS*

## 7" LED SEALED BEAM HEADLAMP



### FEATURES & BENEFITS

- Designed for a standard H4 connection, no additional wiring needed for vehicles featuring standard H4 wiring
- Long-lasting LEDs and impact-resistant polycarbonate lens outperform OEM halogen and incandescent bulbs in longevity, light output and pattern
- Heated Lens (64H71-5) is designed to melt snow/ice in 15-20 minutes



90941-5



64H71-5

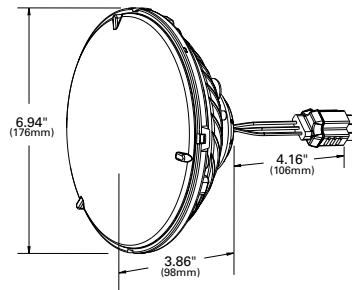
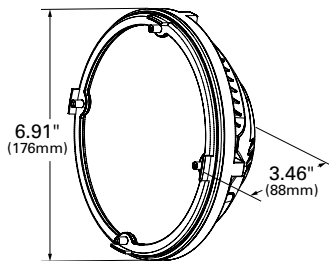

| Part Number                 | FMVSS/SAE           | Product Description           | Low Beam Watt     | High Beam Watt    | Voltage (V) | Amperage (A)   |
|-----------------------------|---------------------|-------------------------------|-------------------|-------------------|-------------|--|
| 90941-5 <b>RETAIL MULTI</b> | HL13                | Grote® 7" LED Head Lamp       | 15                | 27                | 9-32V       | 1.4A at 12.8 low<br>2.13A at 12.8 low                              |
| 64H71-5 <b>RETAIL MULTI</b> | HB: UB3<br>LB: LB3V | 7" Round Heated LED Head Lamp | 15<br>42 (heated) | 20<br>48 (heated) | 12-30V      | 2.91A at 12V<br>1.16A at 30V<br>7.5A at 12V (Heat Function Active) |

### Accessories

| Part Number | Description   |
|-------------|---|
| 68630       | Self-addressable pigtail for vehicles with non-standard H4 wiring |
| 68670       | Constant power harness (Anti-flicker)                             |

| Materials  | Certifications                                   |
|--|--|
| Housing: anodized aluminum, Lens UV-coated polycarbonate | 7" lamp meets DOT, FMVSS, SAE standards for 2D-1 |

*All figures listed are based on nominal voltage*

### Interchange

| Part Number      | Replaces Halogen Lamp |
|------------------|-----------------------|
| 90941-5, 64H71-5 | H6024                 |

VMRS Code: 034-001-151

LED

## 5"X7" LED SEALED BEAM HEADLAMP

## FEATURES &amp; BENEFITS

- Designed for a standard H4 connection, no additional wiring needed for vehicles featuring standard H4 wiring
- Long-lasting LEDs and impact-resistant polycarbonate lens outperform OEM halogen and incandescent bulbs in longevity, light output and pattern
- Heated Lens (64H81-5) is designed to melt snow/ice in 15-20 minutes

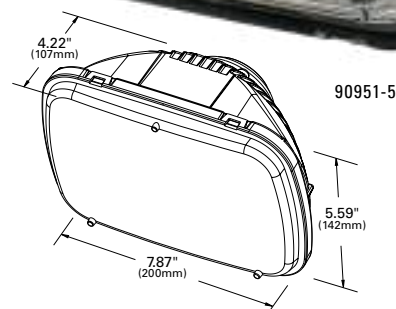

90951-5



64H81-5 - Heated

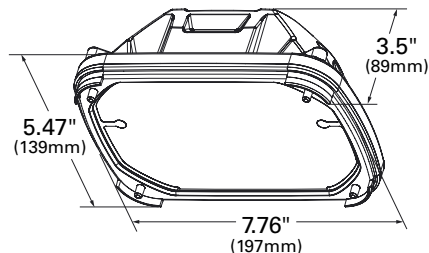

| Part Number                         | FMVSS/SAE           | Product Description               | Low Beam Watt     | High Beam Watt    | Voltage (V) | Amperage (A)   |
|-------------------------------------|---------------------|-----------------------------------|-------------------|-------------------|-------------|--|
| 90951-5 <small>RETAIL MULTI</small> | HL13                | Grote® 5"x7" LED Head Lamp        | 21                | 33                | 9-32V       | 1.59A at 12.8 low<br>2.54A at 12.8 high                    |
| 64H81-5 <small>RETAIL MULTI</small> | HB: UB3<br>LB: LB3V | Grote® 5"x7" Heated LED Head Lamp | 15<br>42 (Heated) | 20<br>48 (Heated) | 12-30V      | 2.91A at 12V H+L<br>7.5A at 12V H+L (Heat Function Active) |

## Accessories

| Part Number | Description   |
|-------------|---|
| 68630       | Self-addressable pigtail for vehicles with non-standard H4 wiring |
| 68670       | Constant power harness (Anti-flicker)                             |

All figures listed are based on nominal voltage

| Materials  | Certifications                                      |
|--|---|
| Housing: anodized aluminum, Lens UV-coated polycarbonate | 5"x7" lamp meets DOT, FMVSS, SAE standards for 2B-1 |

## Interchange

| Part Number | Replaces Halogen Lamp |
|-------------|-----------------------|
| 90951-5     | H6024, 2B-1           |

VMRS Code: 034-001-151



# 4"X6" LED SEALED BEAM HEADLAMP



## FEATURES & BENEFITS

- Designed for a standard H4 connection, no additional wiring needed for vehicles featuring standard H4 wiring
- Long-lasting LEDs and impact-resistant polycarbonate lens outperform OEM halogen and incandescent bulbs in longevity, light output and pattern
- Heated lens versions (64J61-5 and 64J71-5) are designed to melt snow and ice in 15-20 minutes



64J71-5

64J61-5



94401-5



94411-5



94421-5

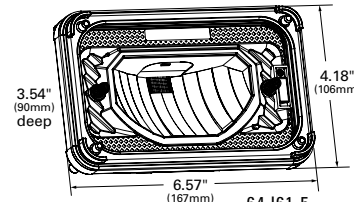
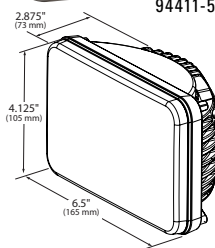
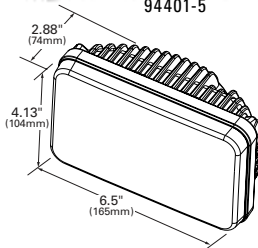

64J61-5

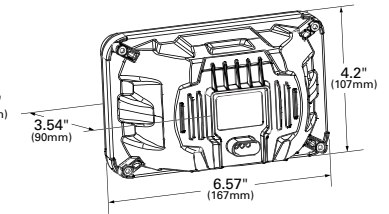

64J71-5

| Part Number                         | FMVSS/SAE | Product Description                         | Low Beam Watt                | High Beam Watt               | Voltage (V) | Amperage (A)  |
|-------------------------------------|-----------|---|------------------------------|------------------------------|-------------|---|
| 94401-5 <small>RETAIL MULTI</small> | HL 17     | Grote® 4"x6" LED Headlamp Combination       | 18.84 at 12V<br>18.84 at 24V | 18.84 at 12V<br>18.84 at 24V | 9-32        | 1.57A at 12V<br>0.77A at 24V                        |
| 94411-5 <small>RETAIL MULTI</small> | HL 16     | Grote® 4"x6" LED Headlamp High Beam         | N/A                          | 17.16 at 12V<br>16.08 at 24V | 9-32        | 1.43A at 12V<br>0.67A at 24V                        |
| 94421-5 <small>RETAIL MULTI</small> | HL 16     | Grote® 4"x6" LED Headlamp Low Beam          | 13.08 at 12V<br>12.72 at 24V | N/A                          | 9-32        | 1.09A at 12V<br>0.53A at 12V                        |
| 64J61-5 <small>RETAIL MULTI</small> | LB1V      | Grote® 4"x6" Heated LED Headlamp, Low Beam  | 20/35                        | N/A                          | 12-30       | 1.67A at 12V<br>2.91A at 12V (Heat Function Active) |
| 64J71-5 <small>RETAIL MULTI</small> | UB1       | Grote® 4"x6" Heated LED Headlamp, High Beam | N/A                          | 12/35                        | 12-30       | 1A at 12V<br>2.91A at 12V (Heat Function Active)    |

## Accessories

| Part Number | Description   |
|-------------|---|
| 68630       | Self-addressable pigtail for vehicles with non-standard H4 wiring |
| 68670       | Constant power harness (Anti-flicker)                             |

| Materials  | Certifications                      |
|--|-------------------------------------|
| Housing: anodized aluminum, Lens UV-coated polycarbonate | 4"x6" lamps meet DOT, FMVSS 571.108 |

## Interchange

| Part Number               | Replaces Halogen Lamp |
|---------------------------|-----------------------|
| 94401-5, 94411-5, 94421-5 | H5062, 2A-1, 1A-1     |

VMRS Code: 034-001-151

All figures listed are based on nominal voltage



LED

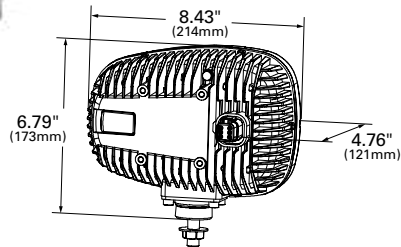

## LED HEATED SNOW PLOW LAMPS

Integrated thermal circuit senses ambient temperature to activate the heating element • Will melt snow and ice in 15-20 minutes

- 84661-4** Heated Lens Right-Hand and Left-Hand Kit **RETAIL MULTI**  
**84631-5** Heated Lens High/Low Beam Head Light, LH **RETAIL MULTI**  
**84641-5** Heated Lens High/Low Beam Head Light, RH **RETAIL MULTI**

**Material:** Lens: Glass; Housing: Die-Cast Aluminum

**Regulations / Standards:** FMVSS 108 / HB - SAE UB3; LB - SAE LB3V, IP67

**Volts / Amps:** 12V-30V;

- 3.5A at 12V High + Low
- 8.34A at 12V Heated High + Low
- 2.5A at 30V High + Low
- 3.34A at 30V Heated High + Low
- Low Beam 22/40W (Heated)
- High Beam 44/60W (Heated)

**VMRS Code:** 034-001-074

**per-lux**  
BY Grote



64291-4

## PER-LUX® SNOWPLOW LAMPS

Resilient, polycarbonate housing and halogen sealed beam withstands hours of use at sub-zero temperatures • Features integrated parking and turn signal lights • Rubber shock mount and center mounting stud absorbs road shock • Optional 5-way Packard® Connector

### SEALED BEAM:

- 64261-4** Pair Pack  
**64241** Left-hand Side  
**64251** Right-hand Side

### SEALED BEAM WITH CONNECTOR:

- 64291-4** Pair Pack

**Material:** Polycarbonate

**Regulations / Standards:** FMVSS 108 / SAE H, I2, P

**Finish:** Black

**Volts / Amps:** Bulb H6545, Major - 65 Watt, 40,000 C.P./Minor -  
 45 Watt, 25,000 CP: 12V / 5.0/3.5A  
 Bulb 1157, 32/3 CP: 12V / 2.1/.59A

**Pigtail:** 68680 (64291-4)

**Lens:** Yellow 90483

**VMRS Code:** 034-001-074

## SNOWPLOW LAMP KIT WITH UNIVERSAL WIRING HARNESS

Integrated turn signal/parking lamp lens • Vibration-dampening mounting system prolongs bulb life • Kit includes left and right side lamps, heavy-duty selector switch, wiring connectors, mounting hardware, and easy installation instructions

- 63381** Left-Hand Side
- 63391** Right-Hand Side
- 63451-4** Pair Pack

**Material:** Polycarbonate

**Regulations / Standards:** FMVSS 108 / SAE H, I2, P

**Finish:** Black

**Volts / Amps:** Bulb H6054, Major - 65 Watt/Minor - 35 Watt; 12V / 5/2.7A  
Bulb: 1157, 32/2 CP: 12V / 2.1/.59A  
Bulb: 1156, 32 CP: 12V / 2.1A

**VMRS Code:** 034-001-074



## LED COMBINATION HEAD LAMPS

Integrated DT connector (pigtail included) • Includes high, low, turn, and parking light integrated rear facing turn

- 84651-4** Combination Right Hand and Left Hand Kit **RETAIL MULTI**
- 84611-5** High/Low Beam Headlight, LH **RETAIL MULTI**
- 84621-5** High/Low Beam Headlight, RH **RETAIL MULTI**

**Material:** Lens: Polycarbonate; Housing Die-Cast Aluminum

**Regulations / Standards:** FMVSS 108 / HB - SAE UB3; LB - SAE LB3V, IP67

**Volts / Amps:** 12V-36V;  
3.83A at 12V, 1.27A at 36V  
Low Beam 14W / High Beam 32W

**VMRS Code:** 034-001-074



## LED FOG LAMPS

SAE J583™ compliant LED headlamps • Integrated DT connector harness included with kits • Two options for mounting flexibility, bracket mount or bezel flush mount

- 64H51-4** 2 Each 64H51-5 Bracket Mount Fog Lamps **RETAIL FOG MULTI**
- 64H51-5** Bracket Mount LED Fog Lamp **RETAIL FOG MULTI**
- 64H61-4** 2 Each 64H61-5 Bezel Mount LED Fog Lamps **RETAIL FOG MULTI**
- 64H61-5** Bezel Mount LED Fog Lamp **RETAIL FOG MULTI**

**Material:** Lens: Polycarbonate; Housing: Die-Cast Aluminum; Bracket: Stainless Steel

**Regulations / Standards:** FMVSS 108 / SAE J583™, F

**Volts / Amps:** 12V-36V; 1.42A at 12V, .47 at 36V

**Accessory:** Canbus Adapter Harness: 68650  
Fog Lamp Vehicle Harness: 68660

**VMRS Code:** 034-001-012



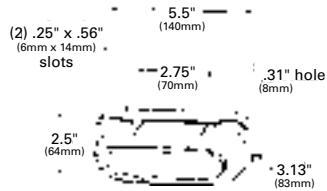

## SLIM-LINE HALOGEN FOG LIGHTS

Housing made of die-cast aluminum • Ion-coated lens • Kit includes lamps, switch, wiring, and instructions • Not compliant for FMCSA 393.24(b) applications

**64371-5** Clear, Fog Lamp Kit **FOG RETAIL**

**Material:** Die-Cast Aluminum

**Regulations / Standards:** FMVSS 108 / SAE F

**Finish:** Black

**Volts / Amps:** 12V / 4.7A

**Bulb:** H3, 55 Watt, 121 CP

**Accessory:** Bulb: 90971-5

**VMRS Code:** 034-001-012

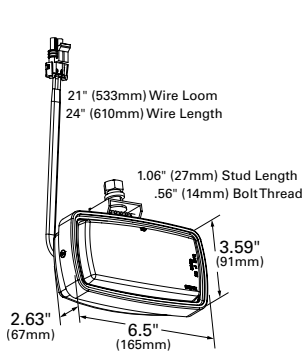

## HALOGEN FOG LAMP

Glass lens resists hazing • Aluminized reflector for increased brightness  
• Black powder-coated hardware • Industry-standard electrical connector  
• Watertight design on the front of the lamp • Meets FMCSA 393.25 (b)

**63531** Black **FOG**

**Material:** Glass / Plastic Housing

**Regulations / Standards:** FMVSS 108 / SAE F

**Finish:** Black

**Bulb:** H3, 55 Watt, 121 CP

**Volts / Amps:** 12V / 4.7A

**VMRS Code:** 034-001-012



## PER-LUX® 200 SERIES FOG AND DRIVING LAMPS

Pair Packs include wiring kits • All lamps come with swivel mount

### HALOGEN:

**02001-4** Clear, Fog / Driving Lamp, Swivel Mount, Pair Pack **FOG**

**Material:** Stainless Steel

**Finish:** Stainless

**Bulb:** H7621-1, 20,000 CP

**Volts / Amps:** 12V / 3.9A; 50 Watt

**Lens:** Clear Glass 09561

**VMRS Code:** 034-001-012

**PER-LUX® 500 SERIES FOG AND DRIVING LAMPS**

Pair packs include wiring kits • All lamps come with swivel mount  
 • Fog lamp beam pattern pierces through fog, rain, snow, or dust effectively, focused ahead and low to the road, and giving a side-to-side as well as forward illumination

**HALOGEN:**

- 05001-5** All-Weather Louvered, H9421, Pair Pack, Stainless Steel **RETAIL**
- 05301-5** All-Weather Louvered, H9421, Pair Pack, Powder Steel **RETAIL**
- 05041-5** Driving Lights, H9420, Pair Pack, Stainless Steel **RETAIL**
- 05051-5** Fog Lamps, H9415, Pair Pack, Stainless Steel **FOG RETAIL**

**Material:** Stainless Steel

**Finish:** Stainless / Powder Coat

**Volts / Amps:** Bulb: H9421 - 14,000 CP: 12V / 3.9A; 50 Watt  
 Bulb: H9420 - 47,000 CP: 12V / 3.9A; 50 Watt  
 Bulb: H9415 - 12,000 CP: 12V / 2.9A; 37.5 Watt

**Lens:** Clear: Glass 09681

Sealed Beam: All-Weather, Halogen, Sealed Beam Clear H9421  
 Fog Lamp, Halogen, Sealed Beam Clear H9415

**VMRS Code:** 034-001-012

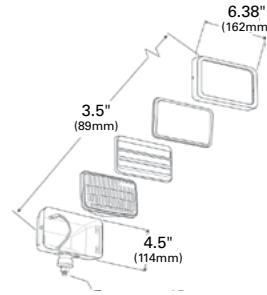

05041-5

**PER-LUX® 600 SERIES FOG AND DRIVING LAMPS**

Louvers direct the beam low to the road so reflected glare from fog, rain or snow is safely avoided • Pierces 100 feet through the densest fog  
 • Rugged stainless steel housing • Pair packs come with wiring kits  
 • Meets FMCSA 393.25(b) applications (except 06001-4)

**INCANDESCENT**

- 06021-4** Clear, All-Weather Lamp, Swivel Mount, Pair Pack **FOG**

**HALOGEN:**

- 06001-4** Clear, All-Weather Lamp, Swivel Mount, Pair Pack
- 06201** Clear, All-Weather Lamp, Swivel Mount

**Material:** Stainless Steel

**Finish:** Stainless

**Volts / Amps:** Bulb: #H7921-1 - 23,900 CP 12V / 3.9A; 50 Watt  
 Bulb: #4921-1 - 25,000 CP: 12V / 7.7A; 100 Watt

**Accessory:** Black Louver 09802

**Lens:** Clear: Glass 09781; Yellow, Glass 09793

Sealed Beam: Clear, All-Weather, Incandescent 4921-1;  
 Clear, All-Weather, Halogen 6006H

**VMRS Code:** 034-001-012



7.5" (191mm)

5.25" (133mm)

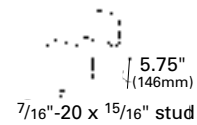

**per-lux**  
BY Grote



## PER-LUX® 700 SERIES FOG AND DRIVING LAMPS

Fog lamp beam pattern pierces through fog, rain, snow or dust effectively, focused ahead and low to the road giving side-to-side as well as forward illumination • Rugged stainless steel housing • Meets FMCSA 393.25(b)

### INCANDESCENT:

**07401** Clear, Fog Lamp, Rigid Mount

**FOG**

**Material:** Stainless Steel

**Regulations / Standards:** Street Legal

**Finish:** Stainless

**Volts / Amps:** Bulb #4912-1, 14,000 CP: 12V / 3.9A; 50 Watt  
Bulb #H7935-1 - 175,000 CP: 12V / 3.9A; 50 Watt  
Bulb #H7921-1 - 23,900 CP: 12V / 3.9A; 50 Watt

**Sealed Beam:** Clear, Fog, Incandescent 4912-1; Clear, Spot, Halogen H7935-1

**VMRS Code:** 034-001-012

1" SQ.  
(25mm)  
Mounting hole for  
1/4" dia. bolt  
.81"  
(21mm)  
"86" Terminal  
"87" Terminal  
"85" Terminal  
"30" Terminal



## FOG AND DRIVING LAMP RELAY

30-Amp relay • Guards against arcing and overloads

**44840-5** **RETAIL**

**Volts / Amps:** 12V / 30A max

**VMRS Code:** 034-003-018



## REPLACEMENT 12-VOLT HALOGEN BULBS

Replacement bulb for auxiliary lights

**90971-5** 55 Watt, Spade Terminal

**RETAIL**

**Bulb:** 90971-5 - H3, 55 Watt, 121 CP

**Volts / Amps:** 12V / 4.7A

**VMRS Code:** 034-004-019

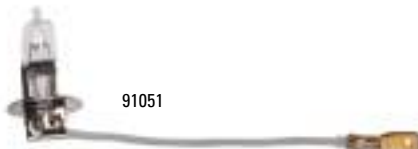

91051

## REPLACEMENT 24-VOLT HALOGEN BULBS

**91051** 70 Watt, Spade Terminal

**24 VOLT**

**Volts / Amps:** 24V / 2.7A

**VMRS Code:** 034-004-019



# VISIT **GROTE.COM** TO GET THE MOST UP-TO-DATE PRODUCT INFORMATION

Whether you prefer desktop, tablet, or mobile, **GROTE.COM** puts all the Grote® lighting and electrical accessory information at your fingertips, wherever you may be.



## **GROTE.COM – THE ULTIMATE REFERENCE!**

- **HIGH-RESOLUTION IMAGERY**
- **UP-TO-DATE STATS AND INFORMATION**
- **UNIQUE 360° VIEWS OF MANY PRODUCTS**
- **LATEST PRODUCT RELEASES**



# 08

## WORK LIGHTING

*LAMPE DE TRAVAIL*

*ILUMINACIÓN DE TRABAJO*

## GROTE® LED WORK LAMPS: HIGH OUTPUT, ULTRA RUGGED

WHEN THE WORK JUST HAS TO GET DONE

### **HIGH OUTPUT:**

Advanced LED technology plus sophisticated reflector optics waste less light, put more usable light on the task.

### **ULTRA RUGGED:**

Field tested to excel in brutal off-road conditions. SAE J575E™-compliant designs protect against vibration, corrosion, moisture, dust, and most direct impacts.

### **COLOR TEMPERATURE OPTIMIZED FOR PRODUCTIVITY:**

Noon-time sun-like color temperature output allows work crews to do better work over longer periods of time without eye fatigue.

### **READY FOR ANYTHING:**

Grote® work lamps provide superior performance on mining, construction, off road, agriculture, utility, and emergency vehicles.



# GROTE® LED RADIUS LIGHT



### FEATURES & BENEFITS

- Tough, durable and lightweight cast aluminum housing
- Six 200-lumen LEDs that produce daylight-like visibility in a broad area
- TIR lens for efficiently distributed lighting
- Bi-voltage system for 12-volt and 24-volt systems
- Vibration-, dust-, corrosion-, and moisture-resistant
- Overvoltage protection to prevent voltage spike damage
- Spacer designed for extended installation and wire routing

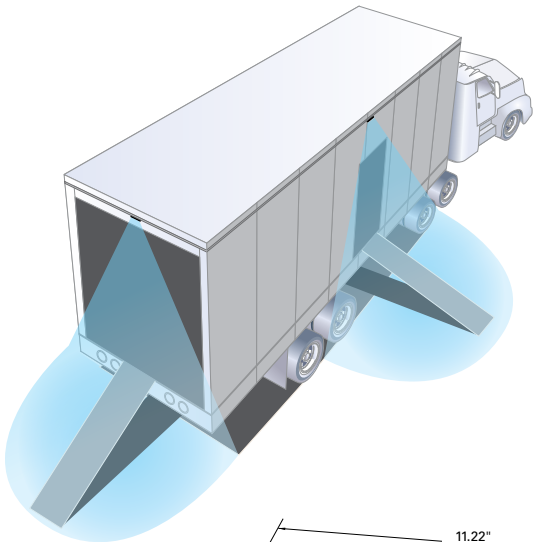
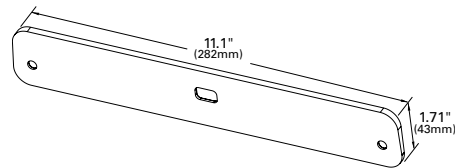
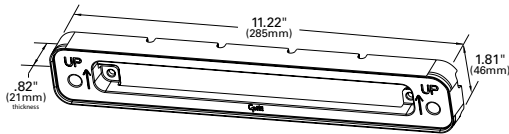
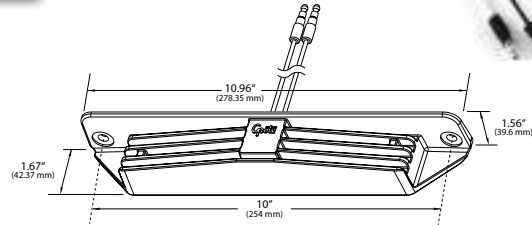

| Part Number                 | Product Description                                       | Voltage (V) | Amperage (A)              |
|-----------------------------|---|-------------|---------------------------|
| 64M11-5 <b>MULTI RETAIL</b> | Grote® Radius Light Assembly<br>Spacer/Wire Guide, Gasket | 12/24       | 1.5A at 12V / .75A at 24V |
| 49501-3                     | Space/Wire Guide, Bulk Pack                               |             |                           |
| 49511-3                     | Gasket, Bulk Pack   |             |                           |

| Materials             | Regulations / Standards               | Ingress Protection |
|-----------------------|---------------------------------------|--------------------|
| Polycarbonate Lens    | FMVSS 108 14.5.1. (Vibration)         | IP69K              |
| Cast Aluminum Housing | FMVSS 108 14.5.3. (Dust)              |                    |
| Weight: 16 oz.        | FMVSS 108 14.5.4. (Corrosion)         |                    |
|                       | SAE 2139 4.2.2 (Submersion)           |                    |
|                       | SAE J1455™ 4.2 (Humidity/Temperature) |                    |

**VMRS Code:** 034-006-031- 64M11-5  
 034-006-034 - 49501-3  
 034-001-122 - 49511-3



## GROTE® LED FAIRING LIGHT



### FEATURES & BENEFITS

- Increases trailer perimeter lighting
- Durable construction with cast aluminum housing & polycarbonate lens
- Low, contoured design minimizes chances of external impact damage
- Bi-voltage system for 12-volt and 24-volt systems
- Includes gasket for surface mounting or spacer/wire guide

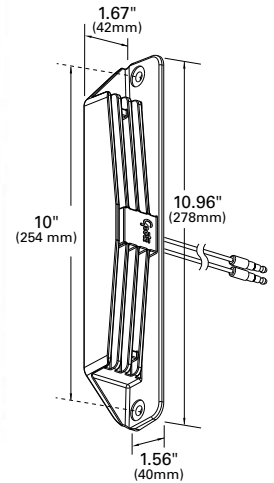
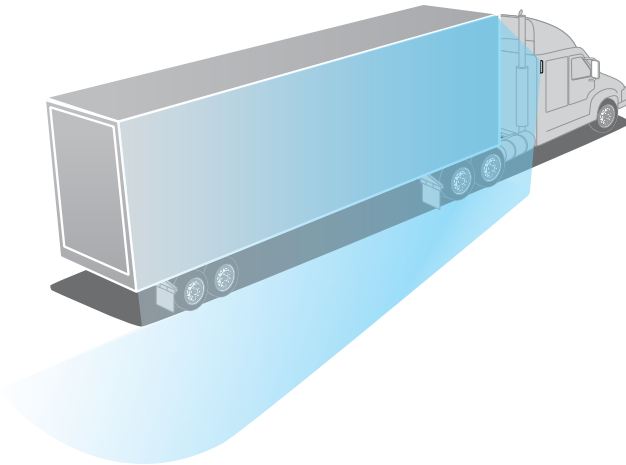

Spacer/Wire Guide



Gasket

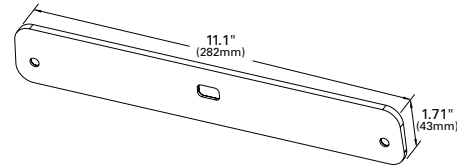
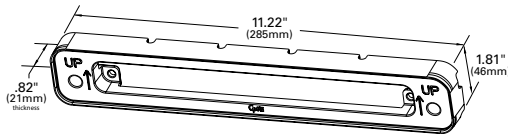

| Part Number                 | Product Description         | Voltage (V) | Amperage (A)              |
|-----------------------------|-----------------------------|-------------|---------------------------|
| 64M21-5 <i>MULTI RETAIL</i> | Grote® LED Fairing Light    | 12/24       | 1.5A at 12V / .75A at 24V |
| 49501-3                     | Space/Wire Guide, Bulk Pack |             |                           |
| 49511-3                     | Gasket, Bulk Pack           |             |                           |

VMRS Code: 034-006-031 - 64M21-5  
034-006-034 - 49501-3  
034-001-122 - 49511-3

| Materials             | Regulations / Standards               | Ingress Protection |
|-----------------------|---------------------------------------|--------------------|
| Polycarbonate Lens    | FMVSS 108 14.5.1. (Vibration)         | IP69K              |
| Cast Aluminum Housing | FMVSS 108 14.5.3. (Dust)              |                    |
| Weight: 16 oz.        | FMVSS 108 14.5.4. (Corrosion)         |                    |
|                       | SAE 2139 4.2.2 (Submersion)           |                    |
|                       | SAE J1455™ 4.2 (Humidity/Temperature) |                    |



## TRILLIANT® CUBE LED WORK LAMPS TIER 1 OUTPUT

LED

### FEATURES & BENEFITS

- Compact 4"x 4" lamps available in 1,200-lumen model
- Highest quality electronic components and advanced Grote® circuit design provides electronically quiet operation. This ensures long life, consistent light output, and protection from voltage spikes and electromagnetic interference
- All-weather design means consistent, reliable light for the task duration regardless of conditions
- Rugged SAE J575E™-compliant construction protects against vibration, corrosion, moisture, and dust
- Sophisticated reflector optics waste less light, focuses more light on task



63991

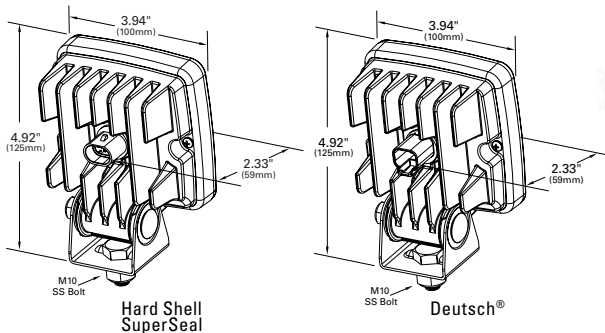

Hard Shell SuperSeal

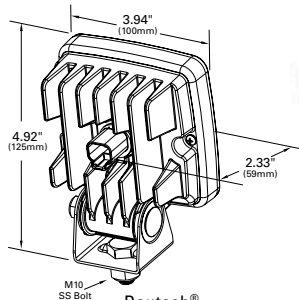

Deutsch®



63L21



63E23



63981

| Part Number | Light Pattern               | Connection Type      | Product Description         | Light Output (Usable Lumens) | Wattage (W) | Voltage (V) | Amperage (A) |
|-------------|-----------------------------|----------------------|-----------------------------|------------------------------|-------------|-------------|--------------|
| 63981       | ECE MULTI Flood             | Hard Shell SuperSeal | 4"X4" Work Lamp W/Pigtail   | 1,200                        | 17          | 12/24       | 1.4/.7       |
| 63981-5     | ECE MULTI RETAIL Flood      | Hard Shell SuperSeal | 4"X4" Work Lamp W/Pigtail   | 1,200                        | 17          | 12/24       | 1.4/.7       |
| 63991       | ECE MULTI Wide Flood        | Hard Shell SuperSeal | 4"X4" Work Lamp W/Pigtail   | 1,200                        | 17          | 12/24       | 1.4/.7       |
| 63991-5     | ECE MULTI RETAIL Wide Flood | Hard Shell SuperSeal | 4"X4" Work Lamp W/Pigtail   | 1,200                        | 17          | 12/24       | 1.4/.7       |
| 63H31       | ECE Flood                   | Deutsch®             | 4"X4" Work Lamp No Pigtail  | 1,200                        | 17          | 48          | 0.35         |
| 63E23       | ECE MULTI Flood             | Deutsch®             | 4"X4" Work Lamp, Amber Lens | 1,200                        | 17          | 12/24       | 1.4/.7       |
| 63L21       | ECE MULTI Near Flood        | Deutsch®             | 4"X4" Work Lamp No Pigtail  | 1,200                        | 17          | 9-32        | 0.75-1.5     |
| 63U01       | ECE Flood                   | Deutsch®             | 4"X4" Work Lamp No Pigtail  | 1,200                        | 23          | 12          | 1.9          |
| 63U41       | ECE Near Flood              | Deutsch®             | 4"X4" Work Lamp No Pigtail  | 1,200                        | 23          | 12          | 1.9          |

All figures listed are based on nominal voltage

### Accessories

| Part Number | Description                            | Fits                           |
|-------------|--|--------------------------------|
| 68580       | Hard Shell SuperSeal Pigtail Blunt Cut | All Hard Shell SuperSeal lamps |
| 68610       | Deutsch Pigtail Blunt Cut              | All Deutsch® lamps             |

| Materials  | Regulations / Standards                               | Ingress Protection |
|--|---|--------------------|
| Powder-Coated Cast Aluminum Housing/CRS, Zinc-Plated Bracket/ Polycarbonate Lens | ECE R10, Dir. 72/245/EEC, Amended by 2006/28/EC<br>CE | IP69K              |

VMRS Code: 034-006-031

## TRILLIANT® CUBE LED WORK LAMP TIER 2 OUTPUT



### FEATURES & BENEFITS

- Compact 4"x 4" lamps available in 2,000- and 3,000-lumen models
- Highest quality electronic components and advanced Grote® circuit design provides electronically quiet operation. This ensures long life, consistent light output, and protection from voltage spikes and electromagnetic interference
- All-weather design means consistent, reliable light for the task duration regardless of conditions
- Rugged SAE J575E™-compliant construction protects against vibration, corrosion, moisture, and dust
- Sophisticated reflector optics waste less light, focuses more light on task



63F61



63F71

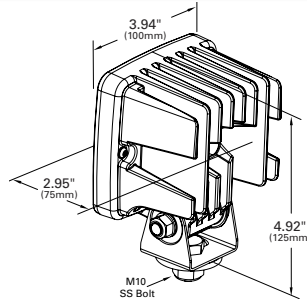

| Part Number                   | Light Pattern | Connection Type      | Product Description         | Light Output (Usable Lumens) | Wattage (W) | Voltage (V) | Amperage (A)              |
|-------------------------------|---------------|----------------------|-----------------------------|------------------------------|-------------|-------------|---------------------------|
| 63W01 <b>ECE</b> <b>MULTI</b> | Long Range    | Deutsch®             | 4"X4" Work Lamp, No Pigtail | 2,000                        | 37          | 9-32V       | 2.6A at 14V<br>1.3 at 28V |
| 63W11 <b>ECE</b> <b>MULTI</b> | Long Range    | Hard Shell SuperSeal | 4"X4" Work Lamp             | 2,000                        | 37          | 9-32V       | 2.6A at 14V<br>1.3 at 28V |
| 63W21 <b>ECE</b> <b>MULTI</b> | Close Range   | Deutsch®             | 4"X4" Work Lamp, No Pigtail | 2,000                        | 37          | 9-32V       | 2.6A at 14V<br>1.3 at 28V |
| 63W31 <b>ECE</b> <b>MULTI</b> | Close Range   | Hard Shell SuperSeal | 4"X4" Work Lamp             | 2,000                        | 37          | 9-32V       | 2.6A at 14V<br>1.3 at 28V |
| 63F21                         | Flood         | Deutsch®             | 4"X4" Work Lamp, No Pigtail | 3,000                        | 36          | 12V         | 3A                        |
| 63F31 <b>ECE</b>              | Flood         | Deutsch®             | 4"X4" Work Lamp, No Pigtail | 3,000                        | 36          | 24V         | 1.5A                      |
| 63F51                         | Wide Flood    | Deutsch®             | 4"X4" Work Lamp No Pigtail  | 3,000                        | 36          | 24V         | 1.5A                      |
| 63F61                         | Flood         | Hard Shell SuperSeal | 4"X4" Work Lamp             | 3,000                        | 36          | 12V         | 3A                        |
| 63W41 <b>ECE</b> <b>MULTI</b> | Long Range    | Deutsch®             | 4"X4" Work Lamp, No Pigtail | 3,000                        | 45          | 9-32V       | 3.2A at 14V<br>1.6 at 28V |
| 63W61 <b>ECE</b> <b>MULTI</b> | Close Range   | Deutsch®             | 4"X4" Work Lamp, No Pigtail | 3,000                        | 45          | 9-32V       | 3.2A at 14V<br>1.6 at 28V |
| 63W71 <b>ECE</b> <b>MULTI</b> | Close Range   | Hard Shell SuperSeal | 4"X4" Work Lamp             | 3,000                        | 45          | 9-32V       | 3.2A at 14V<br>1.6 at 28V |

All figures listed are based on nominal voltage

### Accessories

| Part Number | Description                     | Fits                           |
|-------------|---------------------------------|--------------------------------|
| 68580       | Hard Shell SuperSeal, Blunt Cut | All Hard Shell SuperSeal lamps |
| 68610       | Deutsch®, Blunt Cut             | All Deutsch® lamps             |

VMRS Code: 034-006-031

| Materials  | Regulations / Standards                               | Ingress Protection |
|--|---|--------------------|
| Powder-Coated Cast Aluminum Housing/CRS, Zinc Plated Bracket/ Polycarbonate Lens | ECE R10, Dir. 72/245/EEC, Amended by 2006/28/EC<br>CE | IP69K              |

## TRILLIANT® OVAL LED TIER 1 WORK LAMPS



### FEATURES & BENEFITS

- Highest quality electronic components and advanced Grote® circuit design provides electronically quiet operation. This ensures long life, consistent light output, and protection from voltage spikes and electromagnetic interference
- All-weather design means consistent, reliable light for the task duration regardless of conditions
- Rugged SAE J575E™-compliant construction protects against vibration, corrosion, moisture, and dust
- Two beam patterns to choose from (Flood and Wide Flood). Sophisticated reflector optics waste less light, focuses more light on task

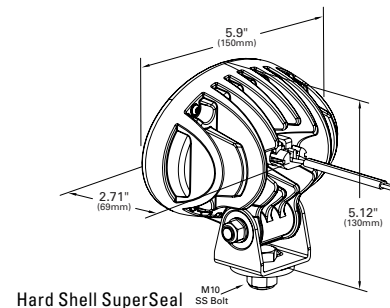
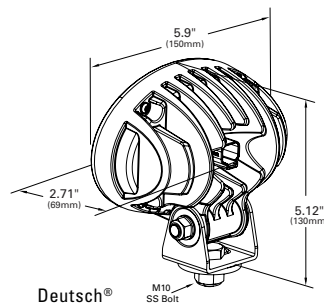

| Part Number                                   | Light Pattern | Connection Type      | Product Description      | Light Output (Usable Lumens) | Wattage (W) | Voltage (V) | Amperage (A) |
|---|---------------|----------------------|--------------------------|------------------------------|-------------|-------------|--------------|
| 63F81 <b>ECE</b> <b>MULTI</b>                 | Flood         | Hard Shell SuperSeal | Oval Work Lamp w/Pigtail | 1,200                        | 24          | 12/24       | 2/1          |
| 63F81-5 <b>ECE</b> <b>MULTI</b> <b>RETAIL</b> | Flood         | Hard Shell SuperSeal | Oval Work Lamp w/Pigtail | 1,200                        | 24          | 12/24       | 2/1          |
| 63F91 <b>ECE</b> <b>MULTI</b>                 | Wide Flood    | Hard Shell SuperSeal | Oval Work Lamp w/Pigtail | 1,200                        | 24          | 12/24       | 2/1          |
| 63G01 <b>ECE</b> <b>MULTI</b>                 | Flood         | Deutsch®             | Oval Work Lamp           | 1,200                        | 24          | 12/24       | 2/1          |
| 63G11 <b>ECE</b> <b>MULTI</b>                 | Wide Flood    | Deutsch®             | Oval Work Lamp           | 1,200                        | 24          | 12/24       | 2/1          |
| 64W01 <b>ECE</b> <b>MULTI</b>                 | Long Range    | Deutsch®             | Oval Work Lamp           | 2,000                        | 37          | 9-32        | 1.3-2.6      |
| 64W11 <b>ECE</b> <b>MULTI</b>                 | Close Range   | Deutsch®             | Oval Work Lamp           | 2,000                        | 37          | 9-32        | 1.3-2.6      |

All figures listed are based on nominal voltage

### Accessories

| Part Number | Description                            | Fits                           | Materials  | Regulations / Standards                         | Ingress Protection |
|-------------|--|--------------------------------|--|---|--------------------|
| 68580       | Hard Shell SuperSeal Pigtail Blunt Cut | All Hard Shell SuperSeal Lamps | Powder-Coated Cast Aluminum                          | ECE R10, Dir. 72/245/EEC, Amended by 2006/28/EC | IP69K              |
| 68610       | Deutsch® Pigtail Blunt Cut             | All Deutsch® Lamps             | Housing/CRS, Zinc Plated Bracket/ Polycarbonate Lens | CE  |                    |

VMRS Code: 034-006-031

# TRILLIANT® OVAL LED TIER 2 WORK LAMPS



## FEATURES & BENEFITS

- Highest quality electronic components and advanced Grote® circuit design provides electronically quiet operation. This ensures long life, consistent light output, and protection from voltage spikes and electromagnetic interference
- All-weather design means consistent, reliable light for the task duration regardless of conditions
- Rugged SAE J575E™-compliant construction protects against vibration, corrosion, moisture, and dust
- Two beam patterns to choose from (Flood and Wide Flood). Sophisticated reflector optics waste less light, focuses more light on task



63J11  
3,000-Lumen Wide Flood



63J01

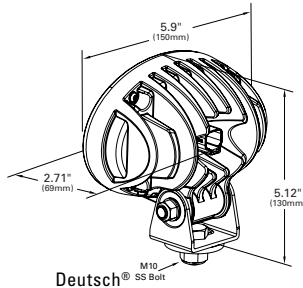

Deutsch®  
M10 SS Bolt

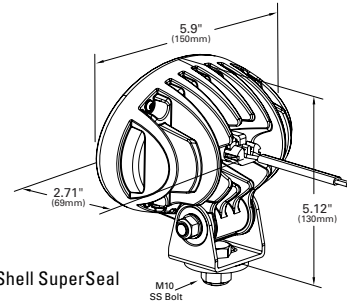

Hard Shell SuperSeal  
M10 SS Bolt

| Part Number                   | Light Pattern | Connection Type      | Product Description                   | Light Output (Usable Lumens) | Wattage (W) | Voltage (V) | Amperage (A) |
|-------------------------------|---------------|----------------------|---------------------------------------|------------------------------|-------------|-------------|--------------|
| 63J01 <b>ECE</b> <b>MULTI</b> | Flood         | Hard Shell SuperSeal | High Output Oval Work Lamp, w/Pigtail | 3,000                        | 36          | 12/24       | 3/1.5        |
| 63J11 <b>ECE</b> <b>MULTI</b> | Wide Flood    | Hard Shell SuperSeal | High Output Oval Work Lamp, w/Pigtail | 3,000                        | 36          | 12/24       | 3/1.5        |
| 63J21 <b>ECE</b> <b>MULTI</b> | Flood         | Deutsch®             | High Output Oval Work Lamp            | 3,000                        | 36          | 12/24       | 3/1.5        |
| 63J31 <b>ECE</b> <b>MULTI</b> | Wide Flood    | Deutsch®             | High Output Oval Work Lamp            | 3,000                        | 36          | 12/24       | 3/1.5        |

All figures listed are based on nominal voltage

## Accessories

| Part Number | Description                            | Fits                           | Materials   | Regulations / Standards                               | Ingress Protection |
|-------------|--|--------------------------------|---|---|--------------------|
| 68580       | Hard Shell SuperSeal Pigtail Blunt Cut | All Hard Shell SuperSeal Lamps | Powder-Coated Cast Aluminum Housing/CRS, Zinc Plate Bracket/ Polycarbonate Lens | ECE R10, Dir. 72/245/EEC, Amended by 2006/28/EC<br>CE | IP69K              |
| 68610       | Deutsch® Pigtail Blunt Cut             | All Deutsch® Lamps             |   |   |                    |

VMRS Code: 034-006-031



## TRILLIANT® MINI LED WORK LAMPS

LED

## FEATURES &amp; BENEFITS

- LEDs are rated for 50,000 hours for long-lasting service
- Polycarbonate hard coated lens provides many years of service
- 3"X5" size makes this lamp a natural LED upgrade for many incandescent and halogen sealed beams

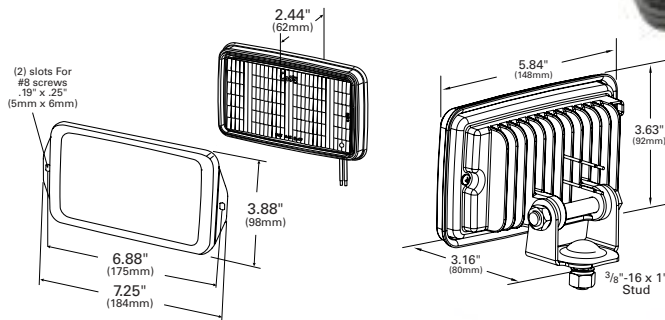

63601

63610  
Flush Mount Version

63621



63611

| Part Number               | Light Pattern | Connection Type | Product Description         | Light Output (Usable Lumens) | Wattage (W) | Voltage (V) | Amperage (A) |
|---------------------------|---------------|-----------------|-----------------------------|------------------------------|-------------|-------------|--------------|
| 63601 <b>ECE</b>          | Spot          | Hardwire        | 3"X5" Work Lamp             | 700                          | 17          | 12          | 1.4          |
| 63601-5 <b>ECE RETAIL</b> | Spot          | Hardwire        | 3"X5" Work Lamp             | 700                          | 17          | 12          | 1.4          |
| 63610 <b>ECE</b>          | Flood         | Hardwire        | 3"X5" Flush Mount Work Lamp | 700                          | 17          | 12          | 1.4          |
| 63602                     | Spot          | Hardwire        | 3"X5" Work Lamp Red Lens    | 135                          |             | 12          | 1.64         |
| 63611 <b>ECE</b>          | Flood         | Hardwire        | 3"X5" Work Lamp             | 700                          | 17          | 12          | 1.4          |
| 63611-5 <b>ECE RETAIL</b> | Flood         | Hardwire        | 3"X5" Work Lamp             | 700                          | 17          | 12          | 1.4          |
| 63731                     | Spot          | Hardwire        | 3"X5" Work Lamp             | 700                          | 17          | 24          | 0.7          |
| 63741 <b>ECE</b>          | Flood         | Hardwire        | 3"X5" Work Lamp             | 700                          | 17          | 24          | 0.7          |
| 63741-5 <b>ECE</b>        | Flood         | Hardwire        | 3"X5" Work Lamp             | 700                          | 17          | 24          | 0.7          |
| 63621 <b>ECE</b>          | Trapezoid     | Hardwire        | 3"X5" Work Lamp             | 700                          | 17          | 12          | 1.4          |
| 63621-5 <b>ECE RETAIL</b> | Trapezoid     | Hardwire        | 3"X5" Work Lamp             | 700                          | 17          | 12          | 1.4          |
| 63751                     | Trapezoid     | Hardwire        | 3"X5" Work Lamp             | 700                          | 17          | 24          | 0.7          |
| 63751-5 <b>ECE RETAIL</b> | Trapezoid     | Hardwire        | 3"X5" Work Lamp             | 700                          | 17          | 24          | 0.7          |

All figures listed are based on nominal voltage

## Accessories

| Part Number | Description                    | Fits  |
|-------------|--------------------------------|---|
| 94690       | Flush mount bracket and gasket | All Trilliant® Mini lamps to convert to Flush Mount |

| Materials   | Regulations / Standards                            | Ingress Protection |
|---|--|--------------------|
| Powder-Coated Die-Cast Aluminium Housing/<br>Polycarbonate Lens<br>Stainless Steel Hardware | ECE R10, Dir. 72/245/EEC,<br>Amended by 2006/28/EC | IP69K              |

VMRS Code: 034-001-015 - 63601, 63601-5, 63602, 63731  
034-006-031 - 63610, 63611, 63611-5, 63741, 63741-5,  
63621, 63621-5, 63751, 63751-5



# TRILLIANT® LED WORK LAMPS



### FEATURES & BENEFITS

- Long-lasting, high output LED work lamp
- Field tested in brutal off-road conditions
- Easily mountable with a durable 1/2" stud mounting bracket, (also features Aim-N-Go technology on some models)

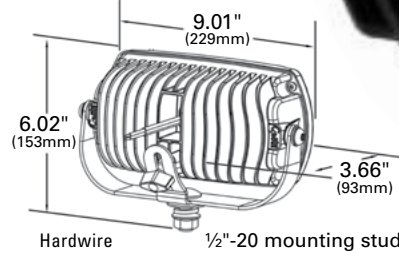
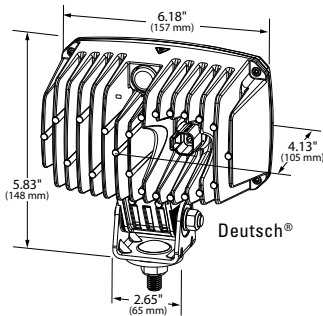

63E41



63Z81

63Z71

63Z61



63591



63571  
Lens Optics Version

| Part Number                   | Light Pattern     | Housing Color | Connection Type | Optic Design | Light Output (Usable Lumens) | Wattage (W) | Voltage (V) | Amperage (A) |
|-------------------------------|-------------------|---------------|-----------------|--------------|------------------------------|-------------|-------------|--------------|
| 63571 <i>ECE</i> <i>MULTI</i> | Spot              | Black         | Hardwire        | Lens         | 1,300                        | 50          | 12/24       | 4.2/2.1      |
| 63581 <i>ECE</i> <i>MULTI</i> | Flood             | Black         | Hardwire        | Lens         | 1,600                        | 50          | 12/24       | 4.2/2.1      |
| 63E41 <i>ECE</i> <i>MULTI</i> | Flood             | Black         | Hardwire        | Reflector    | 2,400                        | 50          | 12/24       | 4.2/2.1      |
| 63E51 <i>ECE</i> <i>MULTI</i> | Wide Flood        | Black         | Hardwire        | Reflector    | 2,200                        | 50          | 12/24       | 4.2/2.1      |
| 63E71                         | Wide Flood        | Black         | Hardwire        | Reflector    | 2,200                        | 50          | 24          | 2.1          |
| 63591 <i>ECE</i> <i>MULTI</i> | Trapezoid         | Black         | Hardwire        | Lens         | 1,600                        | 50          | 12/24       | 4.2/2.1      |
| 63Z61 <i>ECE</i> <i>MULTI</i> | Close/Long Hybrid | Black         | Deutsch®        | Reflector    | 5,000                        | 55          | 14-32       | 4.0-2.0      |
| 63Z71 <i>ECE</i> <i>MULTI</i> | Close Range       | Black         | Deutsch®        | Lens         | 5,000                        | 55          | 14-32       | 4.0-2.0      |
| 63Z81 <i>ECE</i> <i>MULTI</i> | Long Range        | Black         | Deutsch®        | Lens         | 5,000                        | 55          | 14-32       | 4.0-2.0      |

### Accessories

| Part Number | Description   | Fits                 |
|-------------|---------------|----------------------|
| 43652       | Black Bracket | All Trilliant® Lamps |

| Materials   | Regulations / Standards                         | Ingress Protection |
|---|---|--------------------|
| Housing: Powder-Coated Aluminum<br>Bracket: CRS, Black Zinc-Plated<br>Lens: Polycarbonate | ECE R10, Dir. 72/245/EEC, Amended by 2006/28/EC | IP69K              |

All figures listed are based on nominal voltage

VMRS Code: 034-001-015 - 63571  
034-006-031 - 63581, 63E41, 63E51, 63E71, 63591, 63Z61, 63Z71, 63Z81

## T26 LED WORK LAMP

LED

## FEATURES &amp; BENEFITS

- Efficient light engine projects 1,800 to 3,000 effective lumens using only 18 watts of power across 10-48 volts
- Rugged mechanical design ensures consistent performance and long life in the harshest environments
- Small size combined with tough construction allows mounting in places where larger or less rugged lamps cannot fit or survive
- Advanced circuit design provides electronically quiet operation; protects against EMI without interfering with other electronic devices
- Clean, white light designed to represent true colors, just like day light



64G01



64F11 - Flush Mount

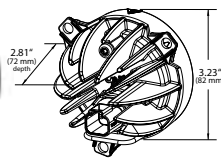

64E11 - Pinch Mount

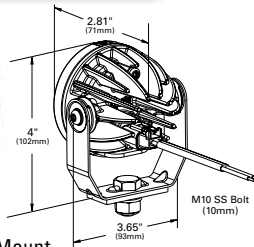

64G11 - Pendant Mount

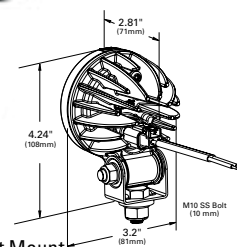

| Part Number                                   | Light Pattern | Connection Type | Product Description | Light Output (Usable Lumens) | Wattage (W) | Voltage (V) | Amperage (A) |
|---|---------------|-----------------|---------------------|------------------------------|-------------|-------------|--------------|
| 64E01 <b>ECE</b> <b>MULTI</b>                 | Far Flood     | Deutsch®        | Pinch Mount         | 1,800                        | 18          | 10-48       | 1.75-.36     |
| 64E01-5 <b>ECE</b> <b>MULTI</b> <b>RETAIL</b> | Far Flood     | Deutsch®        | Pinch Mount         | 1,800                        | 18          | 10-48       | 1.75-.36     |
| 64E11 <b>ECE</b> <b>MULTI</b>                 | Near Flood    | Deutsch®        | Pinch Mount         | 1,800                        | 18          | 10-48       | 1.75-.36     |
| 64E11-5 <b>ECE</b> <b>MULTI</b> <b>RETAIL</b> | Near Flood    | Deutsch®        | Pinch Mount         | 1,800                        | 18          | 10-48       | 1.75-.36     |
| 64F11 <b>ECE</b> <b>MULTI</b>                 | Near Flood    | Deutsch®        | Flush Mount         | 1,800                        | 18          | 10-48       | 1.75-.36     |
| 64F71 <b>ECE</b>                              | Near Flood    | Deutsch®        | Flush Mount         | 1,000                        | 20          | 24          | .88          |
| 64G01 <b>ECE</b> <b>MULTI</b>                 | Far Flood     | Deutsch®        | Pendant Mount       | 1,800                        | 18          | 10-48       | 1.75-.36     |
| 64G01-5 <b>ECE</b> <b>MULTI</b> <b>RETAIL</b> | Far Flood     | Deutsch®        | Pendant Mount       | 1,800                        | 18          | 10-48       | 1.75-.36     |
| 64G11 <b>ECE</b> <b>MULTI</b>                 | Near Flood    | Deutsch®        | Pendant Mount       | 1,800                        | 18          | 10-48       | 1.75-.36     |
| 64G11-5 <b>ECE</b> <b>MULTI</b> <b>RETAIL</b> | Near Flood    | Deutsch®        | Pendant Mount       | 1,800                        | 18          | 10-48       | 1.75-.36     |
| 64G41 <b>ECE</b>                              | Far Flood     | Deutsch®        | Pendant Mount       | 1,000                        | 20          | 12          | 1.7          |
| 64G51 <b>ECE</b>                              | Near Flood    | Deutsch®        | Pendant Mount       | 1,000                        | 20          | 12          | 1.7          |
| 64G61 <b>ECE</b>                              | Far Flood     | Deutsch®        | Pendant Mount       | 1,000                        | 20          | 24          | .88          |
| 64G71 <b>ECE</b>                              | Near Flood    | Deutsch®        | Pendant Mount       | 1,000                        | 20          | 24          | .88          |

All figures listed are based on nominal voltage

## Accessories

| Part Number | Description                            |
|-------------|--|
| 68610       | Replacement Harness - Deutsch® pigtail |
| 01-9950-H1  | Flush Mount Clips                      |

VMRS Code: 034-006-031

| Materials  | Regulations / Standards   | Ingress Protection |
|--|---|--------------------|
| Housing: Powder-Coated Aluminum<br>Lens: Polycarbonate<br>Hardware: CRS, Zinc-plated | SAE J575™ and ISO 60068-2-6:1996 (impact), SAE J1455™ (thermal stress), SAE J2139™ (corrosion), ISO16750-4:2003 (storage temperature) <b>CE</b> | IP69K              |

## TRILLIANT® 36 LED WORK LAMPS



### FEATURES & BENEFITS

- Hard-coated lens for durability and protection against UV
- Thermal pull-back circuit to protect the LEDs from overheating
- Aluminum housing with black powder coating
- Bulb termination accommodates either screw or FastOn cable connections
- Color temperature provides a natural contrast most like sunlight, reducing eye fatigue and optimizing job performance
- Replaceable lens with three stainless steel Phillips head screws



63821



63831

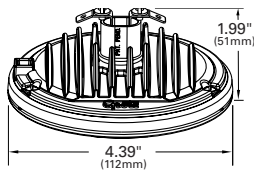

63861



63871

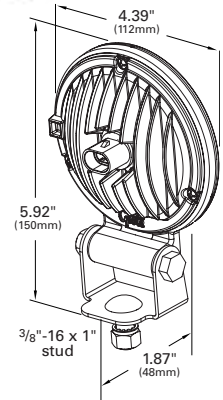

| Part Number                     | Light Pattern | Connection Type       | Product Description      | Light Output (Usable Lumens) | Wattage (W) | Voltage (V) | Amperage (A) |
|---------------------------------|---------------|-----------------------|--------------------------|------------------------------|-------------|-------------|--------------|
| 63971 <i>MULTI</i>              | TractorPlus   | Hard Shell SuperSeal  | Replaceable bulb version | 850                          | 17          | 12/24       | 1.3/.7       |
| 63H81 <i>MULTI</i>              | Wide Flood    | Hard Shell SuperSeal  | Replaceable bulb version | 850                          | 17          | 12/24       | 1.3/.7       |
| 63H01 <i>MULTI</i>              | Wide Flood    | Deutsch®              | Integrated bracket       | 850                          | 17          | 12/24       | 1.3/.7       |
| 63H11 <i>MULTI</i>              | TractorPlus   | Deutsch®              | Integrated bracket       | 850                          | 17          | 12/24       | 1.3/.7       |
| 63821-5 <i>MULTI RETAIL</i>     | TractorPlus   | Spade/Screw Terminals | Replaceable bulb version | 850                          | 17          | 12/24       | 1.3/.7       |
| 63821 <i>MULTI</i>              | TractorPlus   | Spade/Screw Terminals | Replaceable bulb version | 850                          | 17          | 12/24       | 1.3/.7       |
| 63831-5 <i>MULTI RETAIL</i>     | Wide Flood    | Spade/Screw Terminals | Replaceable bulb version | 850                          | 17          | 12/24       | 1.3/.7       |
| 63831 <i>MULTI</i>              | Wide Flood    | Spade/Screw Terminals | Replaceable bulb version | 850                          | 17          | 12/24       | 1.3/.7       |
| 63861-5 <i>MULTI ECE RETAIL</i> | TractorPlus   | Hard Shell SuperSeal  | Integrated bracket       | 850                          | 17          | 12/24       | 1.3/.7       |
| 63861 <i>MULTI ECE</i>          | TractorPlus   | Hard Shell SuperSeal  | Integrated bracket       | 850                          | 17          | 12/24       | 1.3/.7       |
| 63871-5 <i>MULTI RETAIL</i>     | Wide Flood    | Hard Shell SuperSeal  | Integrated bracket       | 850                          | 17          | 12/24       | 1.3/.7       |
| 63871 <i>MULTI</i>              | Wide Flood    | Hard Shell SuperSeal  | Integrated bracket       | 850                          | 17          | 12/24       | 1.3/.7       |

All figures listed are based on nominal voltage

### Accessories

| Part Number | Description                            | Fits                        |
|-------------|--|-----------------------------|
| 68580       | Hard Shell SuperSeal Pigtail Blunt Cut | All Hard Shell SS T36 Lamps |
| 68610       | Deutsch® Pigtail Blunt Cut             | 63H01, 63H11                |

| Materials  | Regulations / Standards                         | Ingress Protection |
|--|---|--------------------|
| Housing: Powder-Coated Aluminum<br>Lens: Polycarbonate | ECE R10, Dir. 72/245/EEC, Amended by 2006/28/EC | IP69K              |

VMRS Code: 034-006-031

## LED BAR LAMPS

LED

## FEATURES &amp; BENEFITS

- Rugged bar lamps feature LEDs to produce a high intensity light output with a color temperature that is easy on the eyes
- Multiple lengths and patterns to make choosing the right lamp a simple process
- Each lamp ships with cast aluminum brackets, harness, relay, fuse and in-dash switch

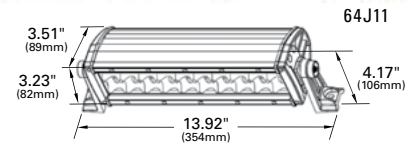

64J11

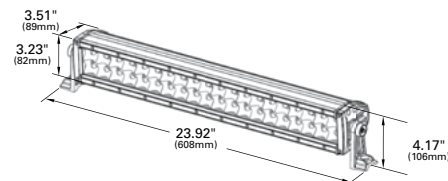

64J21

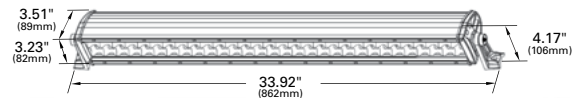

64J31



| Part Number                       | Light Pattern | Product Description | Light Output (Usable Lumens) | LPW (Lumens per Watt) | Voltage (V) | Amperage (A) |
|-----------------------------------|---------------|---------------------|------------------------------|-----------------------|-------------|--------------|
| 64J11 <small>RETAIL MULTI</small> | Far Flood     | 10" Double Row      | 2,700                        | 61                    | 12/24       | 3.5/1.5      |
| 64J21 <small>RETAIL MULTI</small> | Far Flood     | 20" Double Row      | 5,400                        | 61                    | 12/24       | 7/3          |
| 64J31 <small>RETAIL MULTI</small> | Far Flood     | 30" Double Row      | 8,100                        | 61                    | 12/24       | 10.5/4.5     |

*All figures listed are based on nominal voltage*

## Accessories

| Part Number  |
|--|
| Replacement Harness: 67760 (10" lamp), 67770 (20"-50" lamps) |
| Hardware Kit: 98160  |
| Relay: 84-1093 For use with harness if voltage over 14V      |

| Materials                  | Regulations / Standards                        | Ingress Protection |
|----------------------------|--|--------------------|
| Housing: Anodized Aluminum | 400N pull test (harness), ASTM B117 Corrosion, | IP67 and IP69K     |
| Lens: Polycarbonate        | 3.3G Vibration test                            |                    |

VMRS Code: 034-006-031



**BRITE ZONE® DISPLAY PROGRAM**



**00200** 3 Foot In-line / Endcap



**00211** Countertop Display

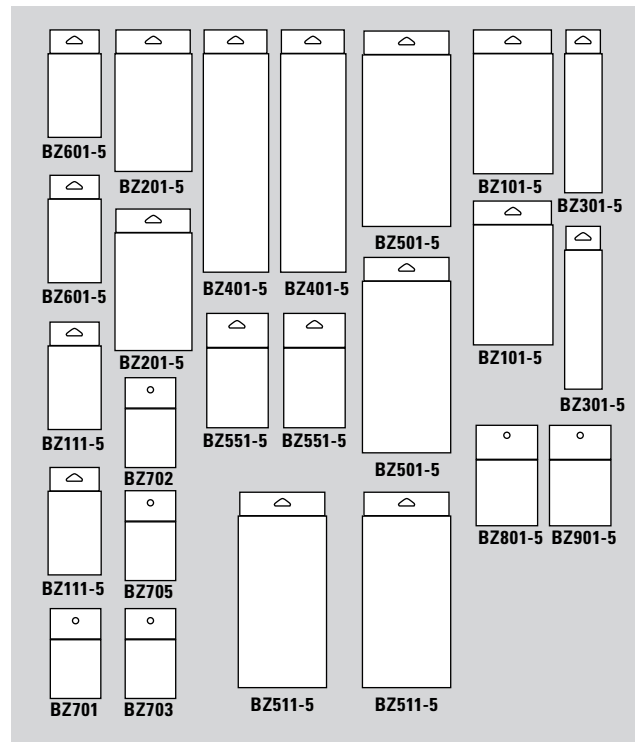

| Part Number | Description                    |
|-------------|--------------------------------|
| 00200       | Brite Zone® In-Line Display    |
| 00211       | Brite Zone® Countertop Display |

VMRS Code: 002-058-017





# BRITE ZONE® HANDHELD LED WORK LAMPS

## FEATURES & BENEFITS

- Go Anywhere LED Work Lamp comes with wall & car chargers, EZ Grip LED Work Lamp comes with a wall charger
- The magnetic polymer base allows you to secure the lamp to most metal surfaces
- With rugged, durable construction and LED power that far outshines halogen, Brite Zone® lamps get the job done
- Long after the sun goes down, whether you're boating, mowing, off-roading, or working, you need lamps as tough and tireless as you are.
- Grote's Brite Zone® range has the LED lamp to shed light on any use – even tow trucks, garbage trucks and forklifts – without breaking the bank



BZ501-5



BZ511-5



BZ801-5



BZ901-5



BZ701

BZ702

BZ703

BZ705

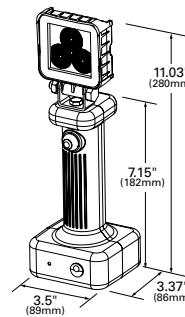
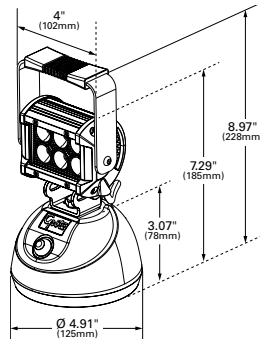

BZ401-5

| Part Number                   | Description                              | LEDs | Power Consumption | Raw Lumens | Voltage (V) |
|-------------------------------|--|------|-------------------|------------|-------------|
| BZ501-5 <small>RETAIL</small> | Go Anywhere LED Work Lamp                | 6    | 12 Watts          | 1,100      | 12 Volts DC |
| BZ511-5 <small>RETAIL</small> | Go Anywhere Mossy Oak Camo LED Work Lamp | 6    | 12 Watts          | 1,100      | 12 Volts DC |
| BZ401-5 <small>RETAIL</small> | EZ Grip LED Work Lamp                    | 3    | 12 Watts          | 775        | 12 Volts DC |
| BZ701 <small>RETAIL</small>   | Clear Lens For BZ501-5                   |      |                   |            |             |
| BZ702 <small>RETAIL</small>   | Red Lens For BZ501-5                     |      |                   |            |             |
| BZ703 <small>RETAIL</small>   | Amber Lens For BZ501-5                   |      |                   |            |             |
| BZ705 <small>RETAIL</small>   | Blue Lens For BZ501-5                    |      |                   |            |             |
| BZ801-5 <small>RETAIL</small> | Wall Charger for BZ401-5 or BZ501-5      |      |                   |            |             |
| BZ901-5 <small>RETAIL</small> | Car Charger for BZ401-5 or BZ501-5       |      |                   |            |             |

All figures listed are based on nominal voltage

### Materials

Lens: Polycarbonate  
 Housing: Die-Cast Aluminum Lamp with Polymer Base  
 Bracket: Stainless Steel

### Light Output

Flood Pattern With  
 Cool White Color

VMRS Code: 034-006-031

## BRITE ZONE® LED WORK LAMPS



### FEATURES & BENEFITS

- With rugged, durable construction and LED power that far outshines halogen, Brite Zone® lamps get the job done
- Long after the sun goes down, whether you're boating, mowing, off-roading, or working, you need lamps as tough and tireless as you are.
- Grote's Brite Zone® range has the LED lamp to shed light on any use – even tow trucks, garbage trucks and forklifts – without breaking the bank
- Value priced to meet any budget



BZ201-5



BZ101-5

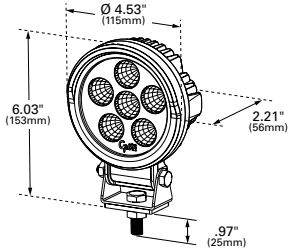
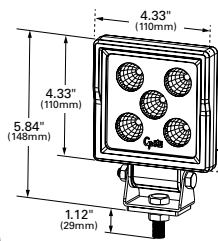

BZ601-5



BZ111-5



BZ551-5



BZ301-5

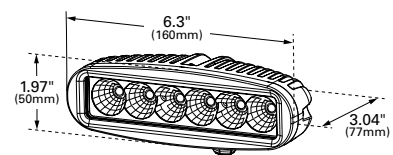
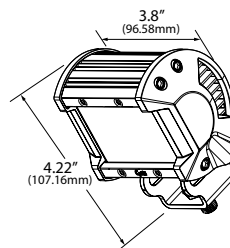
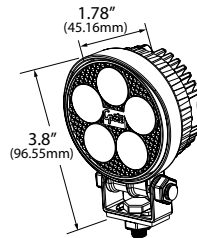
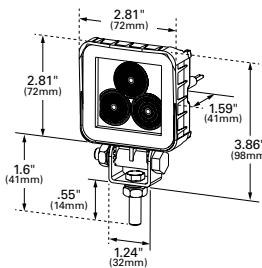

| Part Number                 | Description           | LEDs | Power Consumption | Raw Lumens | Voltage (V) |
|-----------------------------|-----------------------|------|-------------------|------------|-------------|
| BZ101-5 <i>RETAIL MULTI</i> | Round Work Lamp       | 6    | 15 Watts          | 1,600      | 9-32V       |
| BZ201-5 <i>RETAIL MULTI</i> | Square Work Lamp      | 5    | 13 Watts          | 1,100      | 9-32V       |
| BZ301-5 <i>RETAIL MULTI</i> | Slim Work Lamp        | 6    | 15 Watts          | 1,400      | 9-32V       |
| BZ601-5 <i>RETAIL MULTI</i> | Mini Square Work Lamp | 3    | 8.1 Watts         | 775        | 12-36V      |
| BZ111-5 <i>RETAIL MULTI</i> | Small Round Work Lamp | 5    | 14 Watts          | 1,240      | 12-36V      |
| BZ551-5 <i>RETAIL MULTI</i> | Rectangular Work Lamp | 6    | 15 Watts          | 1,200      | 12-36V      |

All figures listed are based on nominal voltage

### Materials

Lens: Polycarbonate  
Housing: Die-Cast Aluminum  
Bracket: Stainless Steel

### Light Output

Flood Pattern With Cool White  
Colorbulb: 24-Volt - H3, 70

VMRS Code: 034-006-031

## PAR 36 UTILITY LAMPS

### FEATURES & BENEFITS

- For versatile application as utility, fifth-wheel, back-up, tractor, forklift or off-road vehicle lamp



64931



64101



64111



63551

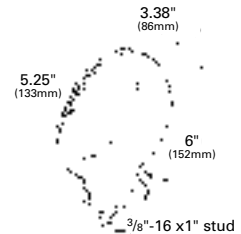
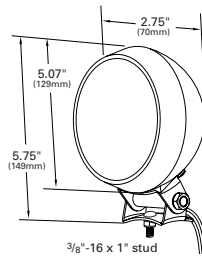
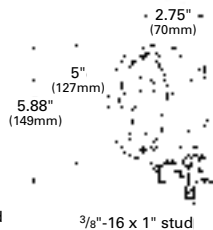
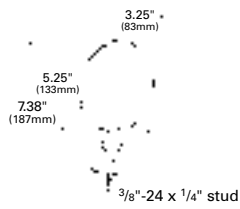

| Part Number                   | Light Pattern | Product Description      | Housing Material | Light Output (CP) | Wattage (W) | Voltage (V) | Amperage (A) |
|-------------------------------|---------------|--------------------------|------------------|-------------------|-------------|-------------|--------------|
| 64931                         | Tractor       | Incandescent Work Lamp   | Rubber           | 3,000             | 35W         | 12V         | 2.7A         |
| 64931-5 <small>RETAIL</small> | Tractor       | Incandescent Work Lamp   | Rubber           | 3,000             | 35W         | 12V         | 2.7A         |
| 64921                         | Tractor       | Incandescent Work Lamp   | Rubber           | 5,000             | 50W         | 24V         | 1.8A         |
| 64101                         | Tractor       | Incandescent Work Lamp   | Steel            | 3,000             | 35W         | 12V         | 2.7A         |
| 64441                         | Trapezoid     | Incandescent Work Lamp   | Steel            | 3,000             | 35W         | 12V         | 2.7A         |
| 64111                         | Spot          | Chrome Surveillance Lamp | Steel            | 33,000            | 35W         | 12V         | 2.7A         |
| 63551                         | Flood         | 4" LED In Rubber Housing | Rubber           | 400 Lm            | 7.7W        | 12V         | 0.6A         |

All figures listed are based on nominal values

### Accessories

| Part Number                   | Product Description               | Fits                 |
|-------------------------------|-----------------------------------|----------------------|
| 64930                         | Rubber Housing                    | Par 36 Bulbs         |
| 43300                         | Magnet Mounting Hardware          | Pedestal Mount Lamps |
| 63821                         | LED Replacement Bulb, TractorPlus | Rubber Lamps         |
| 63821-5 <small>RETAIL</small> | LED Replacement Bulb, TractorPlus | Rubber Lamps         |
| 63831                         | LED Replacement Bulb, Wide Flood  | Rubber Lamps         |
| 63831                         | LED Replacement Bulb, Wide Flood  | Rubber Lamps         |

### Other Replacement Bulbs

| Part Number | Product Description | Fits                |
|-------------|---------------------|---------------------|
| 4411        | Par 36 Bulb         | 64931, 64101, 64441 |
| 4589        | Par 36 Bulb         | 64921               |
| 7400        | Halogen Par 36 Bulb | 64111               |

VMRS Code: 034-001-015 - 64111

034-006-031 - 64931, 64931-5, 64921, 64101, 64441, 63551

## PAR 46 UTILITY LAMPS

### FEATURES & BENEFITS

- For versatile application as utility, fifth-wheel, back-up, tractor, or off-road vehicle lamp



64341

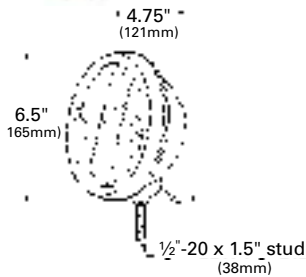

63921

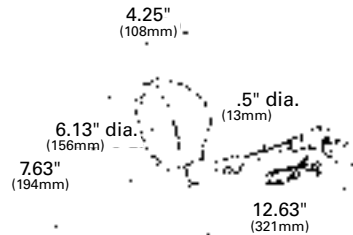

64941

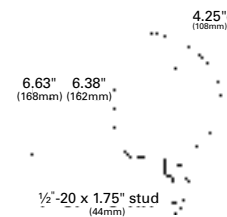

| Part Number | Light Pattern | Product Description   | Housing Material | Light Output (CP) | Wattage (W) | Voltage (V) | Amperage (A) |
|-------------|---------------|---|------------------|-------------------|-------------|-------------|--------------|
| 64941       | Flood         | Incandescent work lamp  | Rubber           | 1,100             | 35W         | 12V         | 2.7A         |
| 64471       | Flood         | Halogen work lamp   | Rubber           | 200,000           | 100W        | 12V         | 7.7A         |
| 64341       | Tractor       | Incandescent work lamp  | Steel            | 1,110             | 35W         | 12V         | 2.7A         |
| 63921       | Spot          | Halogen adjustable surveillance lamp w/ handle, chrome finish | Steel            | 160,000           | 50W         | 12V         | 3.9A         |
| 63941       | Spot          | Halogen adjustable surveillance lamp, chrome finish           | Steel            | 75,000            | 30W         | 12V         | 2.3A         |

All figures listed are based on nominal values

### Accessories

| Part Number | Description            | Fits         |
|-------------|------------------------|--------------|
| 64940       | Rubber Housing         | Par 46 Bulbs |
| 64011       | Steel Housing          | Par 46 Bulbs |
| 64021       | Steel (Chrome) Housing | Par 46 Bulbs |

VMRS Code: 034-001-015 - 63921, 64941  
034-006-031 - 64471, 64341, 63941

### Other Replacement Bulbs

| Part Number | Description                | Fits                              |
|-------------|----------------------------|-----------------------------------|
| 4435        | Spot Pattern Par 46 Lamps  | 64471, 63921, 63941               |
| 4413        | Flood Pattern Par 46 Lamps | 64941                             |
| 4537        | Par 46 Lamps               | 64471, 64941, 64341, 63921, 63941 |

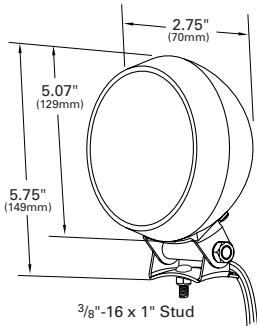

### 4" ROUND UTILITY LAMP

Cost-effective LED lighting option is rated at 50,000 hours • Hardwired for easy integration into current wiring system • Pattern closely resembles a spot pattern

**63561** Clear, Rubber Housing

**Material:** Polycarbonate/Rubber (63561)

**Finish:** Clear/Black (63561)

**Volts / Amps:** 12V / .6A; 282 Lumens

**VMRS Code:** 034-001-015

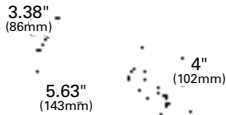

M12 x 28mm lg. stud w/lockout

### COMPOSITE WORK LAMP

Composite design (bulb replaceable) • Multiple beam patterns for use in any application • Side or top mount • John Deere® replacement lamp

**64611** Top Mount, Flood

**Material:** Nylon/Glass

**Finish:** Black

**Volts / Amps:** 12V / 3.9A

**Bulb:** 888, 95 CP

**VMRS Code:** 034-001-015

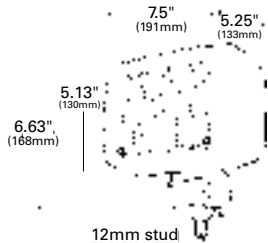

12mm stud

### 4" X 6" RECTANGULAR RUBBER WORK LAMP

Lamps maintains structural integrity through all weather conditions (-50°F to +150°F) • Reinforced, ribbed housing for added strength • Adjustable bracket with 12mm diameter stud

**64891** Flood

**64890** Housing only

**Material:** Rubber

**Finish:** Black

**VMRS Code:** 034-006-031

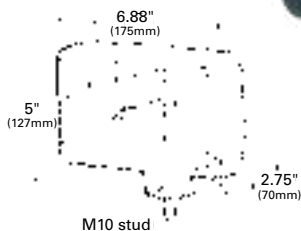

M10 stud

### RECTANGULAR HALOGEN WORK LAMP

Available in trapezoid, spot and flood beam patterns • Rugged corrosion- and shock-resistant construction • For versatile application needs such as tractor, utility, fifth-wheel, or off-road

**63151-5** Flood

RETAIL

**63171-5** Trapezoid

RETAIL

**63241-5** Flood

RETAIL 24 Volts

**Material:** Nylon

**Finish:** Black

**Volts / Amps:** Bulb H3, 55 Watt, 121 CP: 12V / 4.7A

Bulb H3, 70 Watt, 146 CP: 24V / 2.7A



**Accessory:** Bulb: 12V 90971-5, 24V 91051

**VMRS Code:** 034-006-031



### LARGE RECTANGULAR HALOGEN WORK LAMP

Rugged corrosion and shock-resistant construction • For heavy or light duty  
 • Versatile design suitable for applications such as tractor, utility, fifth-wheel, or off-road

**63181-5** Flood   
**63251-5** Flood  

**Material:** Nylon

**Finish:** Black

**Volts / Amps:** Bulb H3, 55 Watt, 121 CP: 12V / 4.7A  
 Bulb H3, 70 Watt, 146 CP: 24V / 2.7A

**Accessory:** Bulb: 12V 90971-5, 24V 91051

**VMRS Code:** 034-006-031

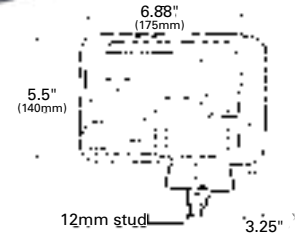

### TWIN-BEAM HALOGEN WORK LAMP

Reinforced nylon housing for strength and durability • Hardened-glass lens resists breakage from road hazards • Complies with SAE J575e™ vibration and corrosion standards

**64901** Flood

**Material:** Nylon, Glass

**Finish:** Black

**Volts / Amps:** 12V / 9.4A, 55 Watt

**Bulb:** H3 (x 2)

**Accessory:** Bulb: 90971-5

**VMRS Code:** 034-006-031

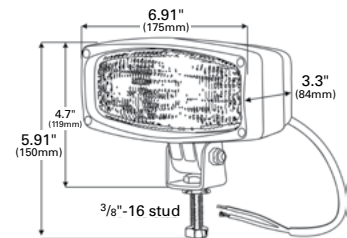

## PIGTAILS FOR WORK LAMPS

For more information on pigtail products see **Pigtails** section: page 254

### DEUTSCH® CONNECTOR

68610 12" Long, Blunt Cut Wires

### HARD SHELL SUPERSEAL CONNECTOR

68580 9" Long, Blunt Cut Wires



## MOUNTING FOR WORK LAMPS

For more information on mounting products see **Mounting Options** section: page 264



### FLUSH-MOUNT WORK LAMP BRACKET

94690 Stainless Steel

**Material:** Stainless Steel  
**Finish:** Stainless Steel

### WORK LIGHT MOUNTING BRACKET

94450 Steel Mounting Bracket

**Material:** 16 GA Steel  
**VMRS Code:** 034-006-034



### ADJUSTABLE BRACKET FOR TRILLIANT® LAMPS

43652 Bracket, Black

**Material:** Zinc  
**Finish:** Black or White

## REPLACEMENT LENSES

| LENS MODEL NUMBER | FITS LAMP | LENS MODEL NUMBER | FITS LAMP |
|-------------------|-----------|-------------------|-----------|
| 09561             | 02001-4   | 09781             | 06021-4   |
| 09681             | 05001-5   |                   | 06001-4   |
|                   | 05301-5   |                   | 06201     |
|                   | 05041-5   | 09793             | 06021-4   |
|                   | 05051-5   |                   | 06001-4   |
|                   |           |                   | 06201     |



09781



09793



09561



09681

# ***SIGN-UP FOR GROTE'S ENHANCED G24/7 VISIT [ORDERS.GROTE.COM](http://ORDERS.GROTE.COM)***



Grote® Industries is pleased to announce the launch of the enhanced G24/7 system. This complimentary service is an innovative way to place orders, track order status and view all your Grote® product activity. From the convenience of your computer or mobile device, you can now access previously unavailable information that will help you more successfully manage your business and inventory.

## ***ORDERS.GROTE.COM***

### **NEW FEATURES**

- ***PAY ANY INVOICE ONLINE ANY TIME***
- ***EASY CREDIT CARD PROCESSING***
- ***NOW MOBILE FRIENDLY***
- ***REPRINT PACKING LISTS AND INVOICES***



#### ***UPLOAD FROM MICROSOFT® EXCEL***

Customers can also upload items from Microsoft® Excel to create orders.

#### ***REFER AND REORDER USING "MY LIST"***

The user can create a list of products for future reference or to reorder.

#### ***E-MAIL NOTIFICATION***

When a new order is created and when an order is shipped, unlimited recipients can receive an instant e-mail notification.

#### ***ORDER ENTRY ONLINE BY CUSTOMER PART NUMBER***

### ***USING G24/7, YOU CAN QUICKLY AND EASILY:***

- Track the status of current orders
- Check the status of backorders
- Check for substitutions or replacements for obsolete parts
- Check Grote® inventory availability
- Confirm ship dates
- Link to shipping carrier
- View invoice information
- Track credits
- View weight & packaging information
- View previously placed orders
- View product technical information
- Reprint packing lists and invoices



**09**

---

**WARNING  
AND HAZARD**

---

***GYROPHARES ET FEUX  
D'AVERTISSEMENT***

---

***LÁMPARAS DE ADVERTENCIA  
Y PRECAUCIÓN***

---





## LED BEACONS, CLASS I, TALL DOME

S-Link™ System\* synchronizing capabilities with up to six other units. Allows for synchronization with other S-Link™ compatible products • Heavy-duty spun aluminum base with plastic base insert • 12 different selectable flash patterns in either of two phases, plus steady-on • High-Low power available on single color beacons & ability to isolate colors on dual color models • Available in dual color flash patterns

|              |                                     |              |
|--------------|-------------------------------------|--------------|
| <b>78010</b> | LED Amber/Blue Beacon w/ Clear Dome | <b>MULTI</b> |
| <b>78011</b> | LED Clear Beacon w/ Clear Dome      | <b>MULTI</b> |
| <b>78013</b> | LED Amber Beacon w/ Clear Dome      | <b>MULTI</b> |
| <b>78015</b> | LED Blue Beacon w/ Clear Dome       | <b>MULTI</b> |
| <b>79070</b> | LED Amber/Green Beacon w/Clear Dome | <b>MULTI</b> |

**Material:** Polycarbonate / Aluminum Base

**Standards:** SAE J845™ Class I (78010, 78011, 78013); Class II (78015); Not SAE Approved (79070)

**Volts / Amps:** 12–24V / 0.6A at 12V

**Lens:** Internal Clear Lens 98251, Internal Amber Lens 98253, Internal Blue Lens 98255, External Clear Lens 98271

**VMRS Code:** 034-006-056



78013



78010



78015

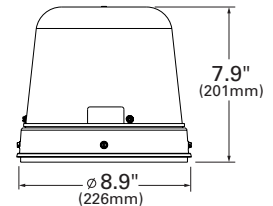

## LED BEACONS, CLASS I, TALL DOME

S-Link™ System\* synchronizing capabilities with up to six other units. Allows for synchronization with other S-Link™ compatible products • Heavy-duty spun aluminum base with plastic base insert • 12 different selectable flash patterns in either of two phases, plus steady-on • Universal mounting: permanent mount, 1" pipe mount • Available in non-rotating single color operation only

|              |                               |              |
|--------------|-------------------------------|--------------|
| <b>79071</b> | LED Clear Beacon w/Clear Dome | <b>MULTI</b> |
| <b>79073</b> | LED Amber Beacon w/Clear Dome | <b>MULTI</b> |
| <b>79075</b> | LED Blue Beacon w/Clear Dome  | <b>MULTI</b> |
| <b>79074</b> | LED Green Beacon w/Clear Dome | <b>MULTI</b> |

**Standards:** SAE J845™ Class I (79071, 79073); Class II (79075); Not SAE approved (79074)

**Volts / Amps:** 12–24V / 0.6A at 12V, 0.3A at 24V

**Lens:** Internal clear lens 98251, Internal Amber Lens 98253, Internal blue lens 98255, External Clear Lens 98271

**VMRS Code:** 034-006-056

## CLASSES I, II, & III – WHICH TO USE WHERE

### CLASS I OPTICAL WARNING DEVICES

Primary optical warning devices for use on authorized emergency vehicles responding to emergency situations. These devices are used to capture the attention of motorists and pedestrians and warn of a potentially hazardous activity or situation.

**Typical Usage**

Fire, Police, Ambulance and Rescue vehicles – authorized vehicles that travel faster than the speed of traffic

### CLASS II OPTICAL WARNING DEVICES

Primary optical warning devices for use on authorized maintenance or service vehicles to warn of traffic hazards such as a lane blockage or slow-moving vehicle.

**Typical Usage**

Utility, roadside assist vehicles, construction vehicles – Over-the-road vehicles traveling at the speed of traffic or stopped at the side of the road

### CLASS III OPTICAL WARNING DEVICES

Primary optical warning devices for use on vehicles authorized to display an optical warning device for identification only.

**Typical Usage**

Forklifts, yard work machines

### S-LINK™ TECHNOLOGY

S-Link™ System is a proprietary technology that will allow similar S-Link™ products to be synchronized. This allows for a user to define the flash patterns on multiple devices for a customized, tailored look on a vehicle. Note: Only S-Link™ compatible products can be synchronized to. Refer to user installation manuals for details on S-Link™ synchronization.



**LED**



78053



78031



78045

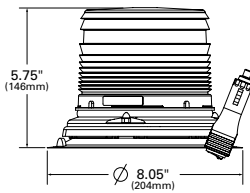
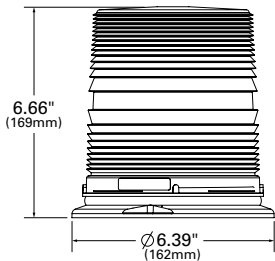
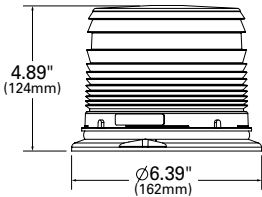

**LED BEACON, CLASS I**

12 different selectable flash patterns in either of two phases, plus steady-on  
 • Circuit board is conformal coated to protect circuitry • S-Link™ System\* synchronizing capabilities with up to six other units Allows for synchronization with other S-Link™ compatible products

- 78030** LED Beacon Amber LED Clear Short Dome **MULTI**
- 78031** LED Beacon Clear Short Dome **MULTI**
- 78032** LED Beacon Red Short Dome **MULTI**
- 78033** LED Beacon Amber Short Dome **MULTI**
- 78034** LED Beacon Green Short Dome **MULTI**
- 78035** LED Beacon Blue Short Dome **MULTI**
- 78050** LED Beacon Amber LED Clear Tall Dome **MULTI**
- 78051** LED Beacon Clear Tall Dome **MULTI**
- 78052** LED Beacon Red Tall Dome **MULTI**
- 78053** LED Beacon Amber Tall Dome **MULTI**
- 78054** LED Beacon Green Tall Dome **MULTI**
- 78055** LED Beacon Blue Tall Dome **MULTI**

**MAGNET MOUNT WITH AUXILIARY ADAPTER:**

- 78041** LED Beacon Clear Vac-Mount
- 78043** LED Beacon Amber Vac-Mount
- 78045** LED Beacon Blue Vac-Mount

**Material:** Polycarbonate  
**Standards:** SAE J845™ Class I (78031, 78033, 78041, 78043, 78051, 78053) Class II (78032, 78035, 78045, 78052, 78055) Not SAE approved (78034, 78054)  
**Volts/Amps:** 12–24V, 0.5A at 12V  
**Accessory:** 6" Branch Guard 98460, 4" Branch Guard 98470  
**Lens:** 98171, 98173, 98175, 98171, 98221, 98223, 98225, 98174, 98224  
**VMRS Code:** 034-006-056

**LED**

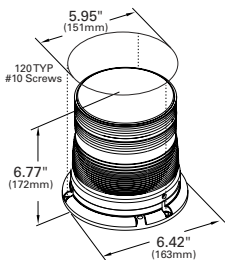

76253

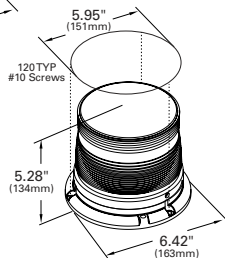

**LED BEACON, CLASS I**

Class I LED beacon is designed to provide optimal lighting for all application needs  
 • Available in low- or high-dome options and 12-volt or 24-volt models  
 • LED technology benefits also include low power draw and reduced on-going maintenance costs and downtime  
 • Permanent mount

- 76253** LED Beacon Amber Short Dome **24 VOLT**
- 76263** LED Beacon Amber Short Dome **24 VOLT**
- 77953** LED Beacon Amber Tall Dome **24 VOLT**
- 77963** LED Beacon Amber Tall Dome **24 VOLT**

**Material:** Polycarbonate  
**Standards:** SAE J845™ Class I  
**Volts / Amps:** 12V / .5A, 1A max, 24V / .2A, .5A max  
**VMRS Code:** 034-006-056

### ROTOLED™ LED HYBRID BEACON, CLASS I

High-intensity LEDs in a rotating warning device with no gears, brushes or bulbs to wear out • Eight 3-watt LEDs with TIR optics produce an exceptionally bright warning device • Temperature range: -22°F to +122°F (-30°C to +50°C) • Polycarbonate lens with UV hard coating – reduces cracking/hazing/fading

- 76683** LED Rotating Beacon Amber Tall Dome **MULTI**
- 76685** LED Rotating Beacon Blue Tall Dome **MULTI**

**Material:** Polycarbonate  
**Standards:** SAE J845™ Class I (Amber); Class II (Blue)  
**Volts / Amps:** 12–24V / 1.7A  
**VMRS Code:** 034-006-056



76683

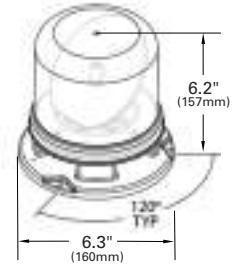

### LED DUAL COLOR BEACONS, CLASS I

S-Link™ System\* synchronizing capabilities with up to six other units Allows for synchronization with other S-Link™ compatible products • Change color selection with the flip of a switch • Circuit boards are conformal coated to protect circuitry • 3-hole permanent mount, 1" pipe mount

- 78070** LED Beacon Amber/Green Short Lens **MULTI**
- 78071** LED Beacon Amber/Clear Short Dome **MULTI**
- 78075** LED Beacon Amber/Blue Short Dome **MULTI**
- 78080** LED Beacon Amber/Green Tall Lens **MULTI**
- 78081** LED Beacon Amber/Clear Tall Dome **MULTI**
- 78085** LED Beacon Amber/Blue Tall Dome **MULTI**

**Material:** Polycarbonate  
**Standards:** SAE J845™ Class I  
 not SAE approved (78080, 78070)  
**Volts / Amps:** 12–24V / 0.6A at 12V  
**Accessory:** 4" Branch Guard 98470; 6" Branch Guard 98460  
**Lens:** 98171, 98221  
**VMRS Code:** 034-006-056



78075



78081

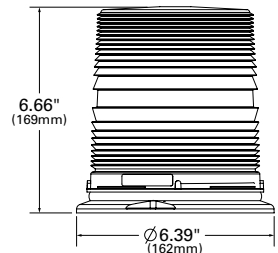
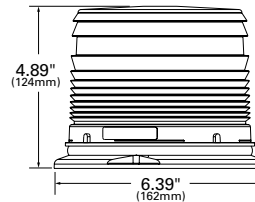

### LED COMPACT BEACON, CLASS I

12 different selectable flash patterns plus steady-on • Permanent mount base with 1/2" pipe mount • SAE Class I beacon in a compact design

- 79093** LED Beacon, Amber, Compact Base 12–24V **MULTI**
- 98513** 7909 Amber Replacement Lens

**Material:** Polycarbonate  
**Standards:** SAE J845™ Class I  
**Volts / Amps:** 12–24V / 0.5A at 12V  
**Lens:** 98513  
**Bracket:** 93604 - 1/2" Mirror Mounting Bracket  
**VMRS Code:** 034-006-056



79093

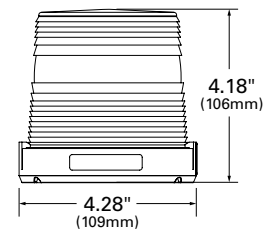

LED



78863

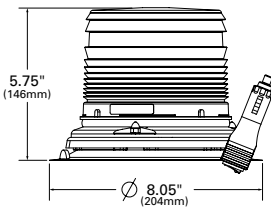

78853

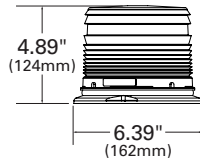

## LED BEACONS, CLASS II, SHORT DOME

26 customer-selectable flash patterns, plus steady-on • Circuit board is conformal coated to protect circuitry • Permanent mount – Durable, lightweight polycarbonate base, flange 3-hole permanent mount, 1" pipe mount.  
• Vac-mount and Magnet Mount, durable, lightweight polycarbonate base, vacuum magnet mount with aux. Plug (on/off and pattern select switch)

|              |                             |              |
|--------------|-----------------------------|--------------|
| <b>78851</b> | LED Beacon Clear Short Dome | <b>MULTI</b> |
| <b>78853</b> | LED Beacon Amber Short Dome | <b>MULTI</b> |
| <b>78855</b> | LED Beacon Blue Short Dome  | <b>MULTI</b> |

### MAGNET MOUNT WITH AUXILIARY ADAPTER:

|              |                            |
|--------------|----------------------------|
| <b>78861</b> | LED Beacon Clear Vac-Mount |
| <b>78863</b> | LED Beacon Amber Vac-Mount |
| <b>78865</b> | LED Beacon Blue Vac-Mount  |

**Material:** Polycarbonate

**Standards:** SAE J845™ Class II (78851, 78853, 78861, 78863); Class III (78855, 78865)

**Volts / Amps:** 78851: 12–24V / 0.35A at 12V; 12V / 0.35A

**Lens:** 98221, 98223, 98225

**VMRS Code:** 034-006-056

LED

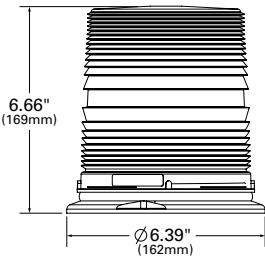

78063

## LED BEACONS, CLASS II, TALL DOME

26 customer-selectable flash patterns, plus steady-on • Circuit board is conformal coated to protect circuitry • Durable, lightweight polycarbonate base, flange 3-hole permanent mount, 1" pipe mount

|              |                                   |              |
|--------------|-----------------------------------|--------------|
| <b>78061</b> | LED Beacon Clear Tall Dome, Clear | <b>MULTI</b> |
| <b>78063</b> | LED Beacon Amber Tall Dome, Amber | <b>MULTI</b> |
| <b>78065</b> | LED Beacon Blue Tall Dome, Blue   | <b>MULTI</b> |

**Material:** Polycarbonate

**Standards:** SAE J845™ Class II

**Volts / Amps:** 12–24V / 0.35A at 12V

**Accessory:** 6" Branch Guard 98460

**Lens:** 98171, 98173, 98175

**VMRS Code:** 034-006-056

LED



77813



77833

## LED BEACON, CLASS II

Rated life of LED strobes is up to 50 times longer than standard strobes

• SignalAlert provides greater visibility by creating a varied flash pattern vs. standard strobes with a consistent flash pattern • LED beacon design internally houses the flash control, eliminating the need for an external power supply or ballast • Scan-Lock™ flash pattern allows the user to manually select from 14 permanent flash patterns

|              |                             |
|--------------|-----------------------------|
| <b>77813</b> | LED Beacon Amber Short Dome |
| <b>77833</b> | LED Beacon Amber Tall Dome  |

### MAGNET MOUNT WITH AUXILIARY ADAPTER:

|              |                             |
|--------------|-----------------------------|
| <b>77823</b> | LED Beacon Amber Short Dome |
| <b>77843</b> | LED Beacon Amber Tall Dome  |

**Material:** Polycarbonate

**Standards:** SAE J845™ Class II

**Volts / Amps:** 12V / .65A max

**VMRS Code:** 034-006-056

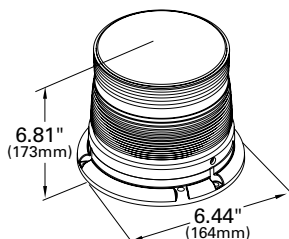
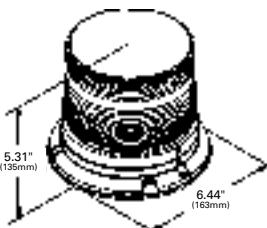

## LED DIN MOUNT BEACONS, CLASS II

Lightweight and durable polycarbonate base with flexible DIN mount

- Modular circuit completely encapsulated for increased shock/weather resistance
- Quad flash pattern

|              |                        |              |
|--------------|------------------------|--------------|
| <b>78122</b> | Red DIN Mount Beacon   | <b>MULTI</b> |
| <b>78123</b> | Amber DIN Mount Beacon | <b>MULTI</b> |
| <b>78125</b> | Blue DIN Mount Beacon  | <b>MULTI</b> |

**Material:** Polycarbonate  
**Standards:** SAE J845™ Class II (Amber, Blue); Class III (Red);  
**Volts / Amps:** 12–24V / 0.4A at 12V  
**Mounting Stem:** 43665  
**VMRS Code:** 034-006-056



78123

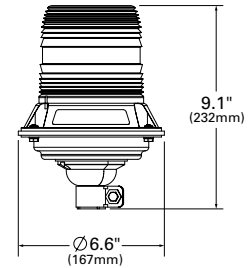

## LED BEACONS, CLASS III

Circuit board is conformal coated to protect circuitry

- Easy "Twist-off" lens for ease of replacement
- Lightweight, durable polycarbonate base

|              |                              |              |
|--------------|------------------------------|--------------|
| <b>78091</b> | LED White Compact Perm Mount | <b>MULTI</b> |
| <b>78092</b> | LED Red Compact Perm Mount   | <b>MULTI</b> |
| <b>78093</b> | LED Amber Compact Perm Mount | <b>MULTI</b> |
| <b>78094</b> | LED Green Compact Perm Mount | <b>MULTI</b> |
| <b>78095</b> | LED Blue Compact Perm Mount  | <b>MULTI</b> |

### MAGNET MOUNT WITH AUXILIARY ADAPTER:

|              |                             |
|--------------|-----------------------------|
| <b>78101</b> | LED White Compact Mag Mount |
| <b>78102</b> | LED Red Compact Mag Mount   |
| <b>78103</b> | LED Amber Compact Mag Mount |
| <b>78104</b> | LED Green Compact Mag Mount |
| <b>78105</b> | LED Blue Compact Mag Mount  |

**Material:** Polycarbonate  
**Standards:** SAE J845™ Class III (Amber Only)  
**Volts / Amps:** 12–72V / 0.17A at 12V  
**Lens:** 98283, 98284, 98285, 98281, 98282  
**VMRS Code:** 034-006-056



78093

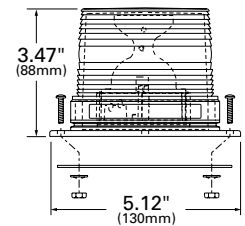

78103

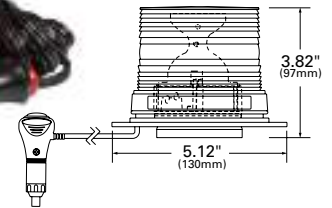

## MIGHTY MINI LED BEACON, CLASS III

Rated life of LED strobes is up to 100 times longer than standard strobes

- SignalAlert provides greater visibility by creating a varied flash pattern (vs. standard strobes with a consistent flash pattern)
- Exclusive side-emitting LED technology rivals standard strobe intensity with a single super LED diode
- LED beacon design internally houses the flash control, eliminating the need for an external power supply or ballast
- 90 flashes per minute

|              |                              |
|--------------|------------------------------|
| <b>77473</b> | LED Amber Compact Perm Mount |
|--------------|------------------------------|

### MAGNET MOUNT WITH AUXILIARY ADAPTER:

|              |                             |
|--------------|-----------------------------|
| <b>77483</b> | LED Amber Compact Mag Mount |
|--------------|-----------------------------|

**Standards:** SAE J845™ Class III  
**Material:** Polycarbonate  
**Volts / Amps:** 12V / .15A  
**VMRS Code:** 034-001-021



77473

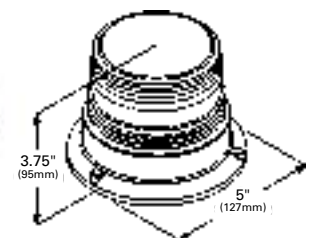



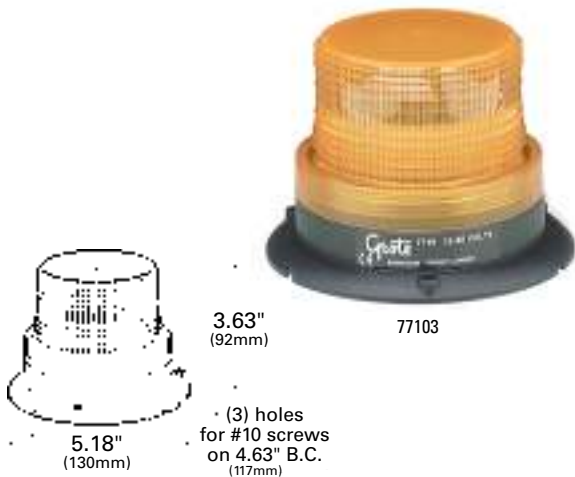

## MIGHTY MINI STROBE

Rugged fiberglass-filled nylon base and polycarbonate lens • Wide voltage operating range • Field-replaceable lens and flash tube • Thread-on lens • 80 flashes per minute; 1.5 joules • Reverse polarity and voltage spike protected

### SINGLE FLASH, PERMANENT MOUNT:

|       |       |              |
|-------|-------|--------------|
| 77101 | White | <b>MULTI</b> |
| 77102 | Red   | <b>MULTI</b> |
| 77103 | Amber | <b>MULTI</b> |
| 77105 | Blue  | <b>MULTI</b> |

**Material:** ABS / Polycarbonate

**Volts / Amps:** 11–80V / .25A at 12V

**Accessory:** Flash Tube: 92980

**Lens:** Amber 92033, 92031, 92032, 92035

**VMRS Code:** 034-001-063

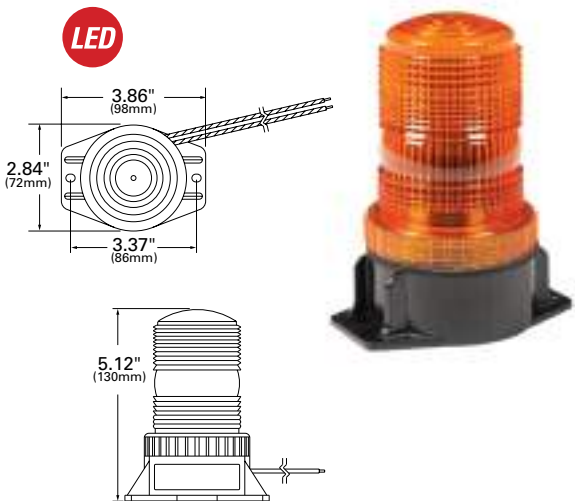

## LED MATERIAL HANDLING BEACON, CLASS III

Compact and powerful LED light output • Easy twist-off lens for ease of replacement • Available flash patterns: single, double and quad • Rated life of LED strobes is up to 50 times longer than standard strobes.

78113 LED Amber Material Handling Beacon **MULTI**

**Material:** Polycarbonate

**Standards:** SAE J845™ Class III

**Volts / Amps:** 12–72V / 0.17A at 12V

**Lens:** 98293

**VMRS Code:** 034-001-063



## MATERIAL HANDLING STROBE

Electronics sealed in epoxy to protect against dust, moisture and vibration

- Thread-on lens for easy maintenance
- Field-replaceable flash tube
- 80 flashes per minute (single flash)
- 2 joules per flash

77012 Red Material Handling Beacon **MULTI**

77013 Amber Material Handling Beacon **MULTI**

**Material:** Nylon / Polycarbonate

**Volts / Amps:** 12–110V / .6A at 12V

**Accessory:** Flash Tube: 92960

**VMRS Code:** 034-001-063



### ECONOMY MATERIAL HANDLING STROBE

Thread-on lens for easy maintenance • Polycarbonate lens and fiberglass-filled nylon base • Reverse polarity and voltage spike protected • 45 lbs. pull magnet for temporary mounting with 12' adapter plug • 1.5 joules per flash, 70 flashes per minute (single flash) • Replaceable flash tube • Removable 1/2 hood included

**77203** Amber Compact Mag Mount



**Material:** Polycarbonate  
**Volts / Amps:** 12–80V / .3A at 12V  
**Accessory:** Flash Tube: 92980  
**Lens:** Amber 92033  
**VMRS Code:** 034-001-063

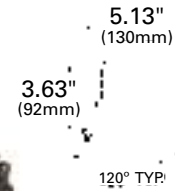

### 360° PORTABLE BATTERY OPERATED LED WARNING LIGHT

24 ultra-bright LEDs help conserve battery life • 300–400 hours of operation on 2 D batteries (not included) • 60 triple flashes per minute • Strong magnet base holds lamp in place on a metal surface • Photocell adjust intensity for low-light situation

**77912** Red  
**77913** Amber

**Material:** Nylon / Polycarbonate  
**VMRS Code:** 034-001-021

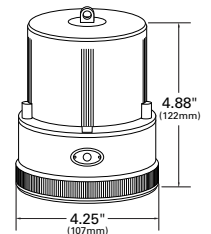

### DIRECTIONAL, PORTABLE, BATTERY-OPERATED LED WARNING LIGHT

Push-button operation • 72 hours of operation on 2 AA batteries (not included) • Includes a magnetic base and is adjustable 180° • Additional reflective lens as added safety feature • 3 user-selectable flash patterns

**77923** Amber

**Material:** Nylon / Polycarbonate  
**VMRS Code:** 034-001-021

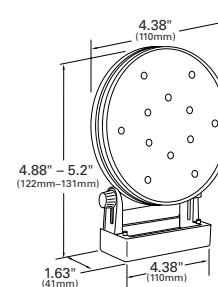

### ECONOMY 360° FLASHING AUXILIARY WARNING LAMP KIT

For use when maximum warning is not required • Bright chrome-plated steel weather-proof base • 60–90 flashes per minute • Flasher can be bypassed for steady burn

**76083** Amber

**Material:** Steel / Acrylic  
**Bulb:** #1295, 50 CP  
**Volts / Amps:** 12V / 3A  
**Lens:** 90353  
**VMRS Code:** 034-001-021

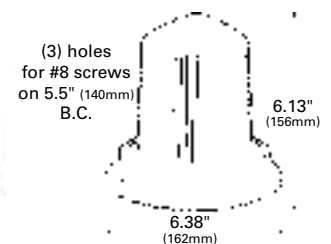

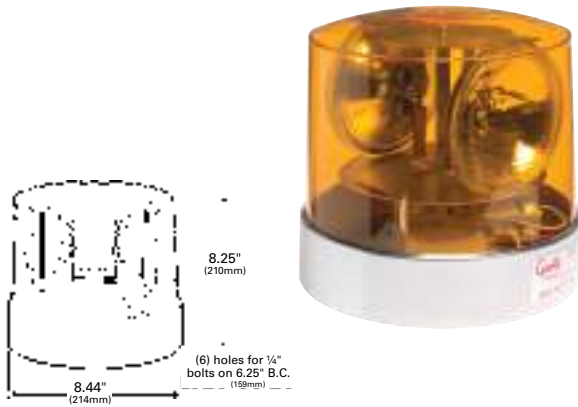

## TWO SEALED-BEAM ROTO-BEACON, CLASS I

Clutched gear box is sealed and permanently lubricated • Revolves 360°, 60–120 flashes per minute

**76223** Amber

**Material:** Stainless Steel / Aluminum / Acrylic / Polycarbonate

**Bulb:** 7400 SB, 33,000 CP

**Standards:** SAE J845™ Class I

**Volts / Amps:** 12V / 5.9A

**Lens:** 90373

**VMRS Code:** 034-006-056

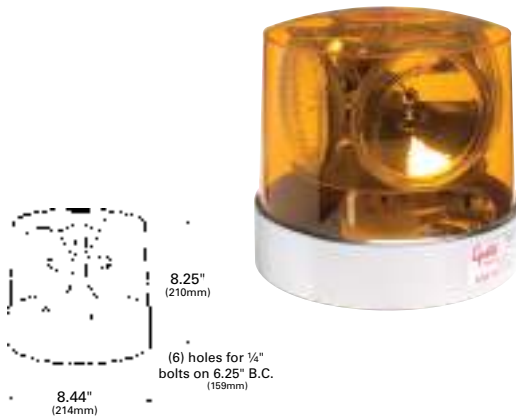

## COMPACT FOUR SEALED-BEAM ROTO-BEACON, CLASS I

Clutched gear box design and "suitcase" latch design • Permanently lubricated sealed gear box • Revolves 360°, 60-120 flashes per minute

**76203** Amber

**Material:** Stainless Steel / Aluminum / Acrylic / Polycarbonate

**Standards:** SAE J845™

**Bulb:** 7400 SB, 33,000 CP

**Volts / Amps:** 12V / 11.7A

**Lens:** 90373

**VMRS Code:** 034-006-056



## TEARDROP "KOJAK" LIGHT

Low-power consumption light • Auxiliary power plug with coiled cord • Magnetic mount

**76033** Amber **RETAIL**

**Material:** Acrylic

**Bulb:** 67, 4 CP

**Volts / Amps:** 12V / 1.64A

**VMRS Code:** 034-001-021

### LED MINI LIGHT BARS, CLASS I

S-Link™ System\* synchronizing capabilities with up to six other units  
 • Allows for synchronization with other S-Link™ compatible products (Magnet Mount not S-Link™ compatible) • Low profile reduces drag and friction • 20 customer selectable flash patterns via external pattern select wire

- 78020** LED Amber/Blue Minibar w/ Clear Lens **MULTI**
- 78023** LED Amber Minibar **MULTI**
- 78024** LED Green Minibar **MULTI**
- 78025** LED Blue Minibar **MULTI**
- 79053** LED Amber Minibar w/ Clear Lens **MULTI**

**MAGNET MOUNT WITH AUXILIARY ADAPTER:**

- 78130** LED Amber/Blue Minibar Vac-Mount
- 78133** LED Amber Minibar Vac-Mount
- 78135** LED Blue Minibar Vac-Mount
- 78443** LED Amber Minibar Mag-Mount
- 79060** LED Amber Minibar w/ Clear Lens

**Material:** Polycarbonate  
**Standards:** SAE J845™ Class I; not SAE approved (78024)  
**Volts / Amps:** 12-24V / 2.3A at 12V  
**Lens:** 98311, 98313, 98314, 98315  
**VMRS Code:** 034-001-021

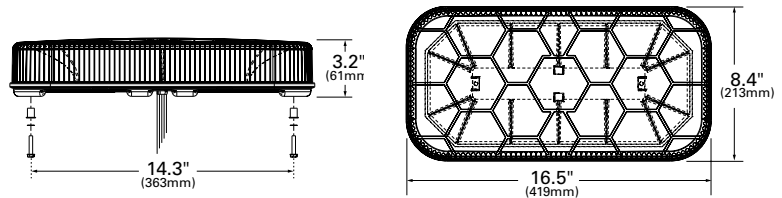

### AMBER TOW BARS, CLASS I

Built in stop/tail/turn functionality with rear-facing work lights (select models) • Ability to isolate extra bright front and rear amber LED modules with separate enable wires • 12 customer selectable flash patterns  
 • Low profile design at 2 1/2" high • Includes simple bracket for permanent mounting or optional gutter kits are available for various makes and models of vehicles.

- 79153** 58" Amber Towbar with S/T/T and Worklights
- 79143** 51" Amber Towbar with S/T/T and Worklights
- 79133** 51" Amber Towbar

**Material:** Aluminum base - Polycarbonate Lens  
**Standards:** SAE J845™ Class I  
**Volts / Amps:** 12V  
**Accessories:** 98542 - Tow Bar Bracket for Spotlight, 98532 - Optional Roof Mount Bracket, 42400 - 4.6" Flex Gutter Kit, 42410 - 6.2" Flex Gutter Kit, 42420 - 8.4" Flex Gutter Kit  
**VMRS Code:** 034-001-021

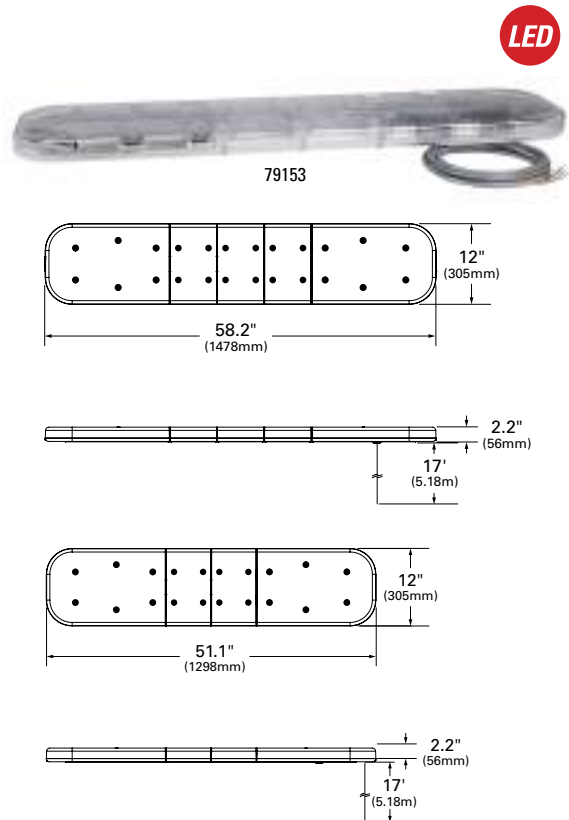

LED



76983



76990

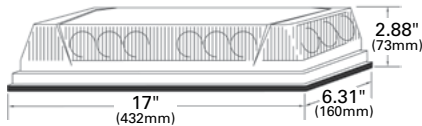

## 17" LOW-PROFILE LED MINI LIGHTBAR, CLASS I/II

Low profile provides high performance characteristics of LED lighting in a small size • 6 internal LED modules provide 360° light output • Built-in electronic flasher with 46 Scan-Lock™ flash patterns (30 for 76770, 76983, 76993) plus 4 simulated rotating patterns (permanent-mount version only) • Permanent mount includes 6" pigtail; magnetic mount includes 8' straight cord with accessory plug that includes LED indicator switch • Permanent mount on 14 1/16" x 3 7/16" hole centers • Mounting hardware and instructions included

### PERMANENT MOUNT:

|              |                                       |
|--------------|---------------------------------------|
| <b>76983</b> | Amber                                 |
| <b>76770</b> | Amber/Blue, Clear Lens, Dual Function |
| <b>76943</b> | Amber, Clear Lens                     |
| <b>76980</b> | Amber/White Split LEDs / Clear Lens   |
| <b>76985</b> | Blue                                  |

### MAGNET MOUNT WITH AUXILIARY ADAPTER:

|              |                                     |
|--------------|-------------------------------------|
| <b>76990</b> | Amber/White Split LEDs / Clear Lens |
| <b>76993</b> | Amber                               |
| <b>76953</b> | Amber, Clear Lens                   |

**Material:** Polycarbonate  
**Standards:** SAE J845 Class I (Amber); Class II (Blue)  
**Volts / Amps:** 12V / 3A peak / 1.2A avg  
**Lens:** 99213  
**VMRS Code:** 034-001-021

LED



77223



77803

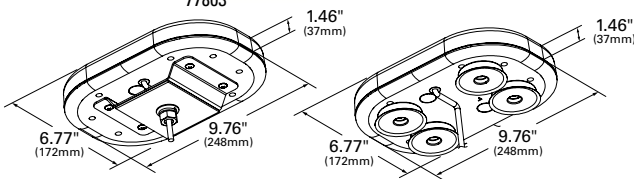

## COMPACT MINI BAR ULTRA-LOW PROFILE, CLASS I

22 customer-selectable flash patterns via external pattern select wire on permanent models • Ultra-low profile reduces drag and friction • Magnetic mounted products come complete with an auxiliary power plug for on/off function and 22 user selectable flash patterns • Can be used in various applications such as pick-up trucks, cars or heavy duty vehicles.

|              |                           |              |
|--------------|---------------------------|--------------|
| <b>77223</b> | Single-Bolt Mount Bracket | <b>MULTI</b> |
| <b>77803</b> | Magnet Mount              | <b>MULTI</b> |

**Material:** Polycarbonate  
**Standards:** SAE J845 Class I  
**Volts / Amps:** 12-24V / 2.0A at 12V  
**VMRS Code:** 034-001-021

LED

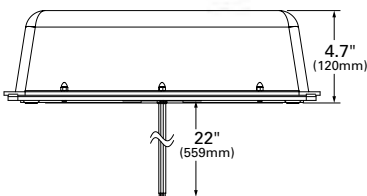

## LED MINI STROBE LIGHT BARS, CLASS II

17 selectable flash patterns in either of two phases, or steady-on • Full gasket protects lamp internal components from dirt, grime and other contaminants

|              |                               |              |
|--------------|-------------------------------|--------------|
| <b>79043</b> | LED Amber Dual Strobe Minibar | <b>MULTI</b> |
|--------------|-------------------------------|--------------|

**Material:** Polycarbonate  
**Standards:** SAE J845™ Class II  
**Volts / Amps:** 12-24V / 0.8A at 12V  
**Lens:** 98373, 98383  
**VMRS Code:** 034-001-021

## INCANDESCENT MINI LIGHT BARS, CLASS I

Gasket between lens and base for increased protection of internal components • Durable polycarbonate plastic base

**78513** Amber Dual Rotator Minibar, Amber

**Material:** Polycarbonate  
**Standards:** SAE J845™ Class I  
**Volts / Amps:** 12V / 8A at 12V  
**Lens:** 98373, 98383  
**VMRS Code:** 034-001-021

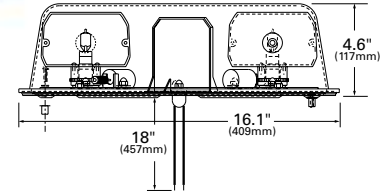

## LED DIRECTIONAL WARNING LIGHTS, CLASS I/II

S-Link™ system synchronizing capabilities with up to six other units  
 • Allows for synchronization with other S-Link™ compatible products • Ultra low profile; single and split color models • Robust design, die-cast aluminum base  
 • 12 different selectable flash patterns in either of two phases, plus steady-on

### 6-DIODE

|                |                             |                     |
|----------------|-----------------------------|---------------------|
| <b>78140</b>   | LED Amber/Green Directional | <b>MULTI</b>        |
| <b>78141</b>   | LED Clear Directional       | <b>MULTI</b>        |
| <b>78142</b>   | LED Red Directional         | <b>MULTI</b>        |
| <b>78143</b>   | LED Amber Directional       | <b>MULTI</b>        |
| <b>78144</b>   | LED Green Directional       | <b>MULTI</b>        |
| <b>78145</b>   | LED Blue Directional        | <b>MULTI</b>        |
| <b>78146</b>   | LED Amber/Blue Directional  | <b>MULTI</b>        |
| <b>78460</b>   | LED Amber/Clear Directional | <b>MULTI</b>        |
| <b>78460-5</b> | LED Amber/Clear Directional | <b>MULTI RETAIL</b> |
| <b>79080</b>   | LED Red/White Directional   | <b>MULTI</b>        |

### 3-DIODE

|                |                                  |
|----------------|----------------------------------|
| <b>78161</b>   | LED Clear Directional            |
| <b>78162</b>   | LED Red Directional              |
| <b>78163</b>   | LED Amber Directional            |
| <b>78163-1</b> | Display pack (4 LED Amber 78163) |
| <b>78164</b>   | LED Green Directional            |
| <b>78165</b>   | LED Blue Directional             |

**Material:** Die-cast Aluminum Base  
**Standards:** SAE: J595™ Class I - 78141, 78142, 78143, 78145; Class II - 78146, 78460  
**Volts / Amps:** 12–24V / 0.55A at 12V (78140, 78141, 78142, 78143, 78144, 78145, 78146, 78460); 12V / 0.3A at 12V (78161, 78162, 78163, 78164, 78165)  
**Accessory:** (6-diode only) Chrome Bezel 98390, White Bezel 98400, License Bracket 98350, L Bracket 98360  
**VMRS Code:** 034-001-021

## LED 6-DIODE TRI-COLOR DIRECTIONAL WARNING LIGHTS, CLASS I

18 different selectable flash patterns in either of two phases  
 • 3 independent power wires give you the ability to control each color and pattern independently • Ultra-low-profile can be mounted to almost any flat surface • S-Link™ system synchronizing capabilities allows for synchronization with other S-Link™ compatible products.

|              |                                   |              |
|--------------|-----------------------------------|--------------|
| <b>79100</b> | LED Amber/Blue/White Directional  | <b>MULTI</b> |
| <b>79110</b> | LED Amber/Green/White Directional | <b>MULTI</b> |
| <b>79120</b> | LED Amber/Red/White Directional   | <b>MULTI</b> |

**Material:** Die-cast Aluminum Base  
**Standards:** SAE J595™ Class I (Amber, Blue, Red and White colors only)  
**Volts / Amps:** 12–24V / 0.8A at 12V  
**VMRS Code:** 034-001-021

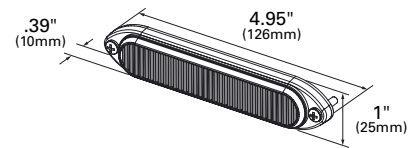
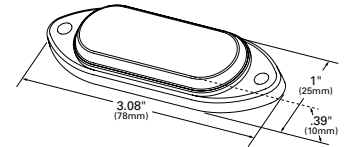
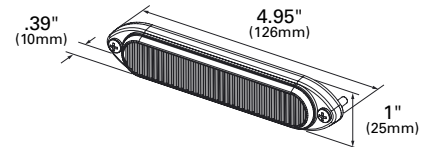

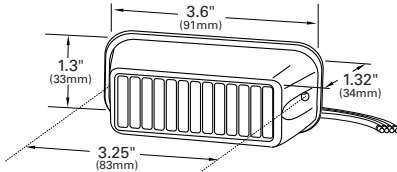

LED

**LED DIRECTIONAL WARNING LAMP, CLASS I**

Versatile LED directional warning light can be synchronized with up to 8 interconnected modules and 25 different built-in flash patterns

- Fully encapsulated, sturdy polycarbonate construction coupled with a dependable gasket design ensures superb moisture and vibration resistance
- Self-contained high intensity, wide-angle LED module
- Horizontal/surface mount only

|              |       |
|--------------|-------|
| <b>77461</b> | Clear |
| <b>77462</b> | Red   |
| <b>77463</b> | Amber |
| <b>77465</b> | Blue  |

**Standards:** SAE J845™ Class I

**Material:** Polycarbonate / Aluminum

**Standards:** SAE J595™ and J845™

**Volts / Amps:** 12V / .16A

**VMRS Code:** 034-001-021

LED

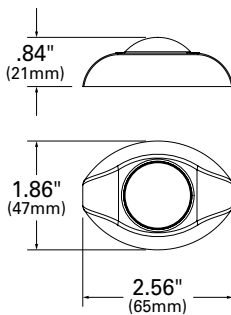
**LED DIRECTIONAL WARNING LAMPS**

S-Link™ system synchronizing capabilities with up to six other units

- Allows for synchronization with other S-Link™ compatible products
- Ultra low profile; Single and split color models
- Robust design, die cast aluminum base
- 12 different selectable flash patterns in either of two phases, plus steady-on

**79033** Mini LED Amber W/Bezel

**79033-5** Mini LED Amber W/Bezel

MULTI

MULTI RETAIL

**Material:** Die-cast Aluminum Base

**Volts / Amps:** 12–24V / 0.6A at 12V

**VMRS Code:** 034-001-021

LED

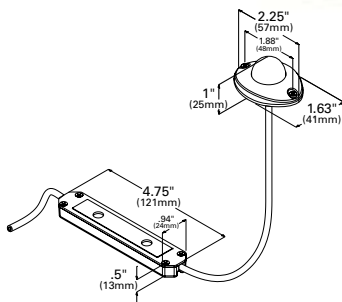

97942 Flange



97943 Flange

**LED VERTEX HIDEAWAY WARNING LAMP, CLASS V**

Ultra-small, self-contained, hemispheric LED light for surface or internal mount within composite headlight, cornering lights and tail light assemblies.

- Flange kit options (in black or chrome) allow easy surface mounting anywhere on your vehicle.
- 25 Scan-Lock™ flash patterns include a synchronize feature for alternating and synchronous flashing of multiple lamps.
- Simple installation; no separate lamp drivers, flashers, ballast or power supplies
- 9-ft. cable length

**77931** Clear

**77932** Red

**77933** Amber

**Material:** Polycarbonate / Aluminum

**Standards:** SAE J1113-41™ Class 5

**Volts:** 10–16V / .75A at 12V

**Bracket:** Black 97943, Chrome 97942

**VMRS Code:** 034-001-021

### AUXILIARY LED WARNING LAMP, CLASS I

4 high-power LEDs with 19 flash patterns • Synchronize option lets you connect multiple heads • Mount anywhere with adjustable bracket • Compact unit with robust aluminum housing for all types of 12V–24V application

- 76792 Red **MULTI**
- 76793 Amber **MULTI**
- 76793-5 Amber **MULTI** **RETAIL**
- 76795 Blue **MULTI**

**Material:** Aluminum  
**Standards:** SAE J595™ Class I  
**Volts / Amps:** 11–30V / .055A at 12V, .026 at 24V  
**VMRS Code:** 034-001-021

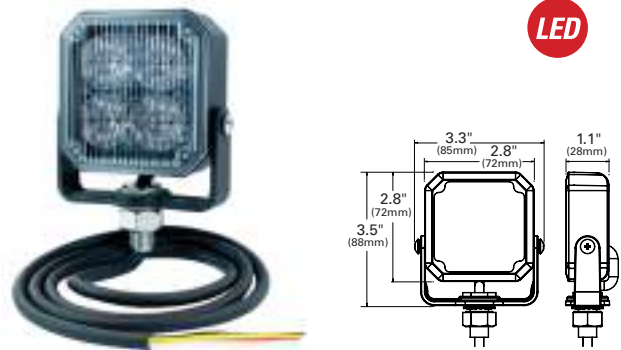

### WING-TIP LED SNOWPLOW WARNING LAMP, CLASS I

LED strobe light modules with 11 light patterns • Water proof TPR cabling w/ built-in strain relief connectors • Encapsulated housing resists vibration, water, salt and chemicals • When both lamps are used the set provides complete coverage whether snowplow blade is down and in use or in the stored travel position

- 78563 Horizontal
- 78573 Vertical

**Material:** Die-Cast Aluminum  
**Standards:** SAE J845™ Class I  
**Volts / Amps:** 12V / .6A  
**VMRS Code:** 034-001-021



### LED WARNING LAMP IN RUBBER HOUSING

Durable rubber lamp housings • Versatile mounting (hardware included) • Molded UBS .180 bullet terminals • Pre-wired for quad or dual flash

- 77193 Amber

**Material:** Rubber / Polycarbonate / Acrylic  
**Standards:** SAE J595™ Class II  
**Volts / Amps:** 12V / .25A  
**Accessory:** Lamp: Red 77352, Amber 77353, Blue 77355, Clear 77351; Housing 64930; Magnet Mount 43300  
**VMRS Code:** 034-001-063

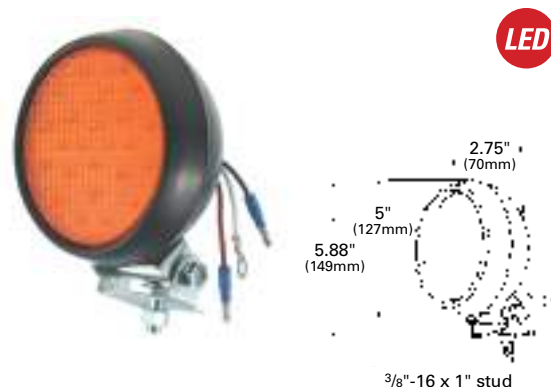

LED

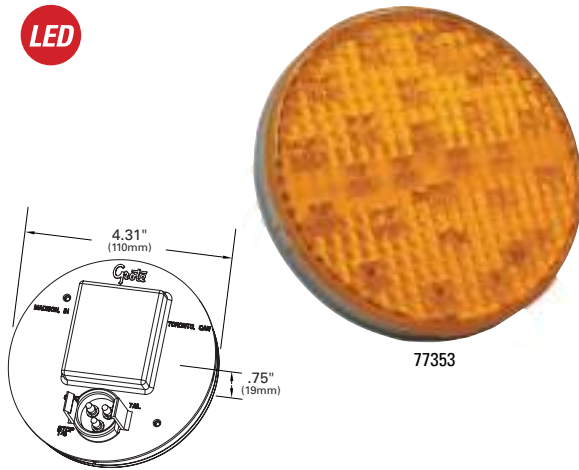
**4" LED AUXILIARY WARNING LAMP, CLASS II/III**

Encapsulant potting offers maximum protection of the circuit board against dirt, moisture and corrosion • Internal circuitry eliminates the need for an external power supply or control module • Functions as either a dual flash strobe or a quad flash strobe • Lamps mount in any orientation • Grote's rugged Plug-and-Go® terminals make for a quick, easy connection every time

|              |       |
|--------------|-------|
| <b>77351</b> | White |
| <b>77352</b> | Red   |
| <b>77353</b> | Amber |
| <b>77355</b> | Blue  |

**Material:** Polycarbonate / Acrylic**Standards:** SAE J595™ Class II (Red, Amber); Class III (Blue)**Volts / Amps:** 12V / .25A**Bracket:** 43253, 92510, 92512, 92513, 43572, 43642, 43655; Grommet: 91740, 91950; Pigtail: 66815, 66841, 67002, 66842, 67013, 66816, 66845, 67005, 66823, 66830, 67016, 66846**VMRS Code:** 034-001-021

LED

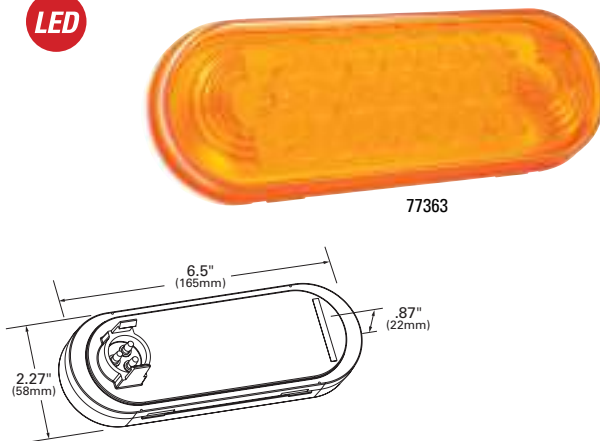
**OVAL LED AUXILIARY WARNING LAMPS, CLASS II/III**

Encapsulant potting offers maximum protection of the circuit board against dirt, moisture and corrosion • Internal circuitry eliminates the need for an external power supply or control module • Functions as either a dual-flash strobe or a quad-flash strobe • Lamps mount in any orientation • Grote's rugged Plug-and-Go® terminals ensure a quick, easy connections every time

|              |       |
|--------------|-------|
| <b>77361</b> | Clear |
| <b>77362</b> | Red   |
| <b>77363</b> | Amber |
| <b>77365</b> | Blue  |

**Material:** ABS / Acrylic**Standards:** SAE J595™ Class II (Red, Amber) quad; Class III (Blue, Amber) dual**Volts / Amps:** 12V / .25A**Bracket:** 43362, 43952, 43220, 43223, 43222, 43100;**Grommet:** 92420, 92720**Pigtail:** 66815, 66841, 67002, 66842, 67013**VMRS Code:** 034-001-021

LED

**LED OVAL WARNING LAMP**

S-Link™ system synchronizing capabilities with up to six other units

- Allows for synchronization with other S-Link™ compatible products •
- Grommet mount can be converted to surface mount with optional chrome or black bezels •
- 12 different selectable flash patterns in either of 2 phases plus steady-on •
- Only .69" thick

|              |                                    |              |
|--------------|------------------------------------|--------------|
| <b>78190</b> | LED 6" Oval Amber/Blue, Clear Lens | <b>MULTI</b> |
| <b>78191</b> | LED 6" Oval Clear, Clear Lens      | <b>MULTI</b> |
| <b>78193</b> | LED 6" Oval Amber, Amber Lens      | <b>MULTI</b> |
| <b>78194</b> | LED 6" Oval Green, Clear Lens      | <b>MULTI</b> |
| <b>78195</b> | LED 6" Oval Blue, Clear Lens       | <b>MULTI</b> |

**Material:** Polycarbonate**Standards:** SAE J595™ Class I (78190, 78191, 78193, 78195); (Green not SAE approved)**Volts / Amps:** 12-24V / 0.3A at 12V**Accessory:** Black Bezel 98410, Chrome Bezel 98480**VMRS Code:** 034-001-021

### LED TRAFFIC STICKS, CLASS I

34 customer-selectable warning flash patterns plus 5 phase options • Made from durable extruded aluminum — will not warp or bend • Front load for easy replacement of individual heads • 20" model comes with a 2' three-wire cable (power, ground, pattern select) • 30" & 40" models come with a 25' six-wire cable, (power, ground, program wire, left enable, right enable, warn enable, center-out = L + R) • 30" & 40" models come with a 25' six wire cable, (power, ground, program wire, left enable, right enable, warn enable, center-out = L + R)

- 78370** LED Amber 20" Warning Stick
- 78380** LED Amber 30" Traffic Director
- 78410** LED Amber 40" Traffic Director

**Material:** Black Anodized Aluminum  
**Standards:** SAE J595™ Class I; Green not SAE approved  
**Volts / Amps:** 12V / 2A (78370)  
 12V / 6A (78380)  
 12V / 8A (78410)  
**Accessory:** Replacement Modules - Amber 98343, 98345  
 Blue, 98341 White, 98342 Red, 98344 Green  
**VMRS Code:** 034-001-021

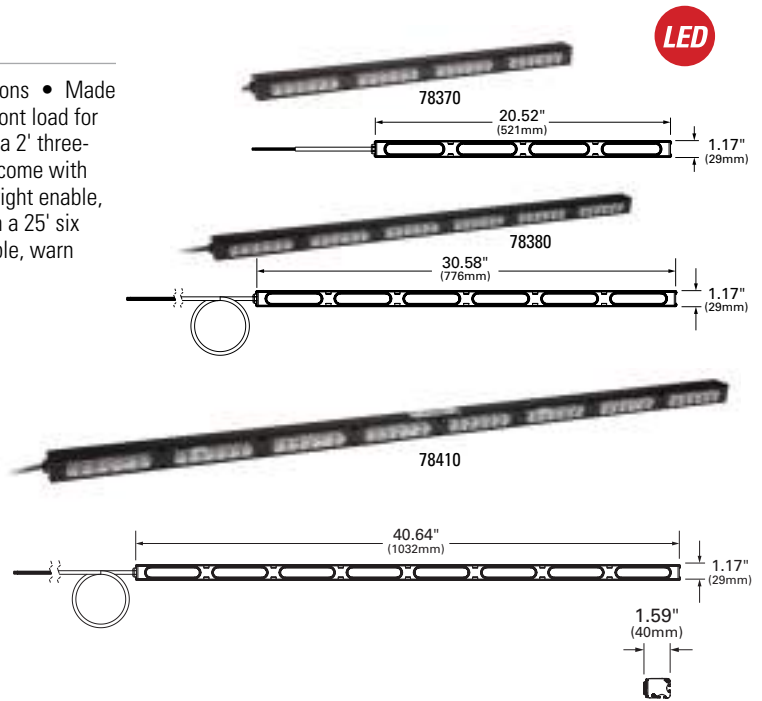

### LED TRAFFIC DIRECTORS & ARROW STICKS

Made from durable extruded aluminum — Traffic Directors will not warp or bend • Front load for easy replacement of individual heads • Ships complete with backlit control unit, attached quick-disconnect wire harness (15' standard), L-brackets, hardware, and instructions

- 78200** LED Amber Traffic Director
- 78210** Small LED Amber Traffic Arrow
- 78270** Large LED Amber Traffic Arrow

**Material:** Black Anodized Aluminum  
**Volts / Amps:** 12V / 2.4A (78200)  
 12V / 3.6A (78210)  
 12V / 4.8A (78270)  
**Accessory:** Amber Module 98333, Control Box 98522, 10' Extension Cable 66650,  
 20' Extension Cable 66660, 40' Extension Cable 66670  
**VMRS Code:** 034-001-021

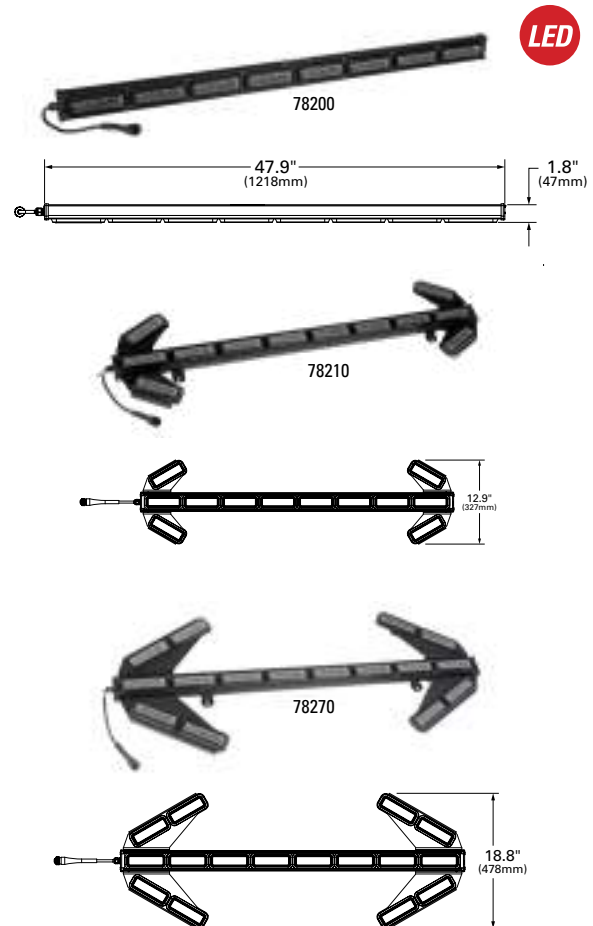

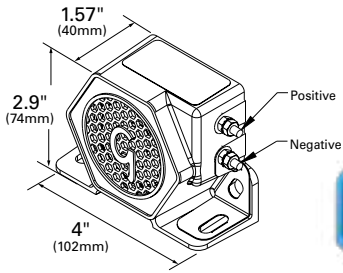

## MEDIUM / LOW NOISE SURROUND BACK-UP ALARM

Electronics sealed in epoxy for protection against dust, vibration and moisture • Self-grounding, eliminates potential corrosion points  
• Universal integral mounting bracket • Voltage-spike and surge-protected

**73040** 97 dB, w/ Wire Studs

**73040-5** 97 dB, w/ Wire Studs

**73090** 107 dB, w/ Wire Leads

**73110** 82–102 dB

MULTI

MULTI RETAIL

MULTI

MULTI

**Material:** Glass-Filled Nylon with Wire Leads

**Standards:** SAE J994™ Type B (73090); Type C (73040); Type F (73110)

**Finish:** Blue

**Volts / Amps:** 12–24V / .4A at 12V

**VMRS Code:** 054-002-001

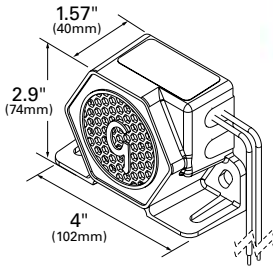
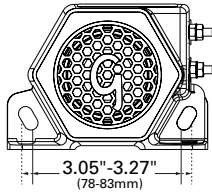

## REVERSE MOUNTED SPEAKER BACK-UP ALARM

Features hardwire terminations • Integral mounting bracket • Electronics completely encapsulated in potting for total circuit board protection

**73250** 107 dB

**73240** 81–107 dB

**73360** 97dB Dual-Tone

**73370** 102dB Dual-Tone

**73350** 97dB Dual-Function

MULTI

MULTI

MULTI

MULTI

MULTI

**Material:** Glass-Filled Nylon

**Standards:** SAE J994™ Type B (73250); Type F (73240);  
Type C (73350, 73360) Back-up function only;  
Type B (73370) Back-up function only

**Finish:** Blue

**Volts / Amps:** 12–24V / 1.7A at 12V (73250)

12–24V / 3A at 12V (73240)

12–24V / .3A at 12V (73360)

12–24V / .7A at 12V (73370)

12–24V / .3A at 12V (73350)

**VMRS Code:** 054-002-001

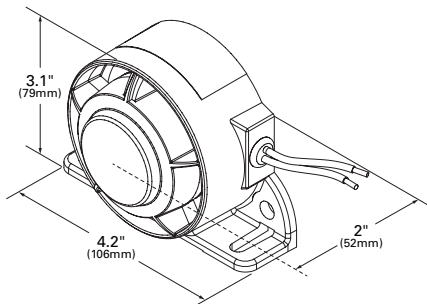



## REVERSE MOUNTED SPEAKER BACK-UP ALARM

- Rugged construction glass-filled nylon housings
- Electronics sealed in epoxy for protection against dust, vibration and moisture
- Universal mounting including grommet mounted products
- Available in a range of decibel output levels to fit a wide variety of application needs

|              |                           |              |
|--------------|---------------------------|--------------|
| <b>73030</b> | 107–112 Selectable dB     | <b>MULTI</b> |
| <b>73070</b> | 112 dB                    | <b>MULTI</b> |
| <b>73080</b> | 87–112 dB, Self-Adjusting | <b>MULTI</b> |

**Material:** Glass-Filled Nylon  
**Standards:** SAE J994™ Type F (73080, 73030); Type A (73070)  
**Finish:** Blue  
**Volts / Amps:** 12–24V / .6A at 12V (73080, 73030)  
 12–24V / 0.3A at 12V (73070)  
**VMRS Code:** 054-002-001

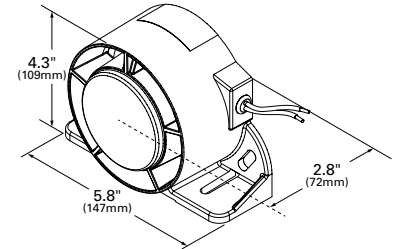

## BACK-UP ALARMS – MULTI FREQUENCY

- Select the right alarm that will best suit your unique environments
- Superior performance and protection from damage to the speaker due to its reverse mounted speaker

|              |                    |              |
|--------------|--------------------|--------------|
| <b>73170</b> | 107 dB, Multi-Freq | <b>MULTI</b> |
| <b>73310</b> | 97 dB, Multi-Freq  | <b>MULTI</b> |

**Material:** Glass-Filled Nylon  
**Finish:** Blue  
**Standards:** SAE J994™ Type B (73170); Type C (73310)  
**Volts / Amps:** 12–24V / 0.3A at 12V  
**VMRS Code:** 054-002-001

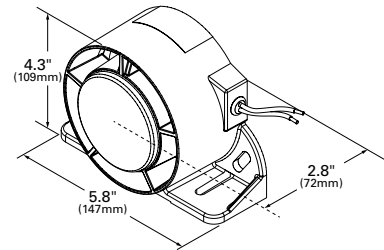

## 4" GROMMET MOUNTED BACK-UP ALARM

- Mounts in standard 4" grommet (grommet not included) • Epoxy sealed to protect against dust, moisture, and vibration

|              |        |              |
|--------------|--------|--------------|
| <b>73160</b> | 107 dB | <b>MULTI</b> |
| <b>73220</b> | 97 dB  | <b>MULTI</b> |

**Material:** Glass-Filled Nylon  
**Standards:** SAE J994™ Type B (73160); Type C (73220)  
**Finish:** Black  
**Volts / Amps:** 12–24V / .4A at 12V  
**Grommet:** 91740  
**VMRS Code:** 054-002-001

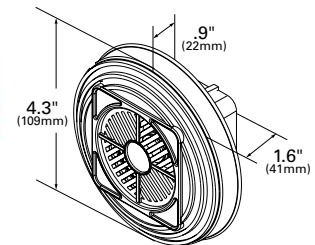



## ELECTRIC AUTOMOTIVE HORNS

Complete with mounting bracket

### FOR IMPORT VEHICLES:

**72010-5** High Tone, 135 dB **RETAIL**

### FOR DOMESTIC VEHICLES:

**72100-5** High Tone, 125 dB **RETAIL**

**72110-5** Low Tone, 125 dB **RETAIL**

**Material:** Steel

**Standards:** SAE J377™

**Finish:** Black Enamel

**Volts / Amps:** 12V

**VMRS Code:** 054-001-001

## BEEPING BACK-UP HALOGEN BULB

Combination audible back-up safety device and lamp in one • Provides a clear beeping sound when vehicle shifts into reverse gear • Alarm does not meet OSHA and SAE J994™ requirements for commercial back-up alarms

### BAYONET BASE: (1156 REPLACEMENT)

**73140-5** **RETAIL**

### WEDGE BASE: (3156 REPLACEMENT)

**73150-5** **RETAIL**

**Volts / Amps:** 12V / 1.67A

**VMRS Code:** 054-002-001

## STROBE POWER MODULE

The Grote® 99630 "X" control strobe module is ideal for use on refuse and waste management vehicles, yard work machines and construction vehicles using a 12V power system wherever a strobing "X" pattern is desired

- This module will provide the necessary strobing functionality with both LED oval and round lamp systems.
- The system utilizes Grote® designed and built circuitry for optimum signal management
- Unit is designed with over-voltage circuit protection and signal and back-up over-rides turn strobe function off when the back-up, left and right turn signals are engaged

**99630** Strobe Power Module

**Material:** Polycarbonate

**Strobe Function:** 'X' Pattern function

**Input Voltage:** 12.8V

**Dimensions:** 1.265" high x 5.44" long

**Max amp draw:** Unit contains a 5 AMP fuse

**VMRS Code:** 034-002-001

## ACTUATION SWITCH

Often utilized with back-up alarms • Activates when shifting vehicle into reverse

**44134** Switch **MULTI**

**Material:** Steel

**Finish:** Zinc Plate

**Volts / Amps:** 12-36V / 5A max

**VMRS Code:** 034-004-081

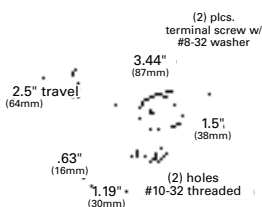
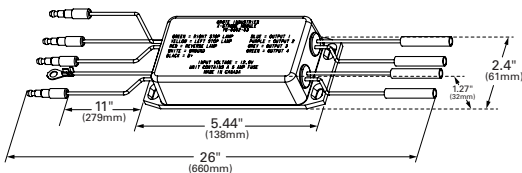

## ACTUATION SWITCH

Heavy-duty usage • Mechanical actuation • Includes mounting bracket and weather-proof compression fitting

44421 Switch **MULTI**

**Material:** Steel  
**Finish:** Zinc  
**Volts / Amps:** 12–80V / 10A max  
**VMRS Code:** 034-003-018

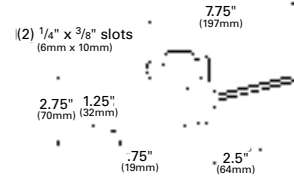

## REPLACEMENT LENSES

| LENS MODEL NUMBER | FITS LAMP | LENS MODEL NUMBER | FITS LAMP | LENS MODEL NUMBER | FITS LAMP |
|-------------------|-----------|-------------------|-----------|-------------------|-----------|
| 90353             | 76083     | 98225             | 78035     | 98282             | 78092     |
| 90373             | 76203     |                   | 78045     |                   | 78102     |
|                   | 76223     |                   | 78855     | 98293             | 78113     |
|                   | 76283     |                   | 78865     | 98311             | 78020     |
| 98171             | 78050     | 98251             | 78010     |                   | 78130     |
|                   | 78051     |                   | 78011     |                   | 79053     |
|                   | 78061     |                   | 79021     |                   | 79060     |
|                   | 78080     | 98253             | 78013     | 98313             | 78023     |
|                   | 78081     |                   | 79023     |                   | 78133     |
|                   | 78085     | 98255             | 78015     |                   | 78443     |
| 98173             | 78053     |                   | 79025     | 98314             | 78024     |
|                   | 78063     | 98271             | 78010     | 98315             | 78025     |
|                   | 78503     |                   | 78011     |                   | 78135     |
| 98175             | 78055     |                   | 78013     | 98373             | 78513     |
|                   | 78065     |                   | 78015     |                   | 79023     |
|                   |           |                   | 79070     |                   | 79043     |
| 98221             | 78030     |                   | 79071     | 98383             | 79023     |
|                   | 78031     |                   | 79072     |                   | 79043     |
|                   | 78041     |                   | 79073     | 98513             | 79093     |
|                   | 78070     |                   | 79074     |                   |           |
|                   | 78071     | 98283             | 78093     |                   |           |
|                   | 78075     |                   | 78103     |                   |           |
|                   | 78851     | 98284             | 78094     |                   |           |
|                   | 78861     |                   | 78104     |                   |           |
|                   | 78015     | 98285             | 78095     |                   |           |
| 98223             | 78033     |                   | 78105     |                   |           |
|                   | 78043     | 98281             | 78091     |                   |           |
|                   | 78493     |                   | 78101     |                   |           |
|                   | 78853     |                   |           |                   |           |
|                   | 78863     |                   |           |                   |           |



S-Link™ is a trademark of Star1889 Headlight & Lantern Co.; Scan-Lock™ is a trademark of Whelen Engineering

All product and company names are trademarks™ or registered® trademarks of their respective holders. Use of them does not imply any affiliation with or endorsement by them.

# 10

---

## **FLASHERS & TURN SIGNAL SWITCHES**

---

***CLIGNOTANTS ET COMMUTATEURS***

---

***PALANCAS DIRECCIONALES /  
DESTELLADORES***

---

## VARIABLE-LOAD ELECTRONIC LED FLASHER

60–120 flashes per minute • Heavy-duty contacts; external wire provides ground • Steady flash rate for all LED and incandescent loads • Flash rate is electronically controlled

### 3 TERMINAL (PILOT):

**44890** Flasher

### 2 TERMINAL:

**44891** Flasher

**Regulations / Standards:** FMVSS 108 / SAE J945™, J590™  
**Volts / Amp:** 12V / 1–20A; 1–10 Lamp Load (Incandescent)  
**VMRS Code:** 034-003-018

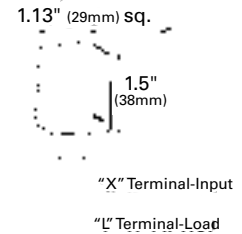

## 3-PIN LED FLASHER

3-pin electronic LED flasher, 12-Volt • Max load: 20 amps • Min Load: .25 amps • Flash rate: 60–120 flashes per minute

**44110** Flasher

**Regulations / Standards:** FMVSS 108 / SAE J945™, J590™  
**Volts / Amp:** 12V / .25–20A  
**VMRS Code:** 034-003-018

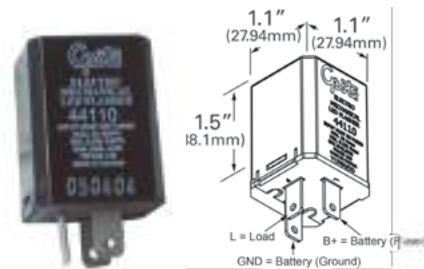

## 5-PIN ELECTRONIC LED FLASHER

Direct replacement for OE flasher • Doesn't require a separate ground wire; uses factory wiring • Provides a steady flash rate for turn signals and hazard lamps even when using LED lamps • Electronically controlled flash rate, maintains the legally compliant flash rate

### 5 PIN:

**44090** ISO Terminals

**Regulations / Standards:** FMVSS 108 / SAE J945™, J590™  
**Volts / Amp:** 12V / 1–20A  
**VMRS Code:** 034-003-018

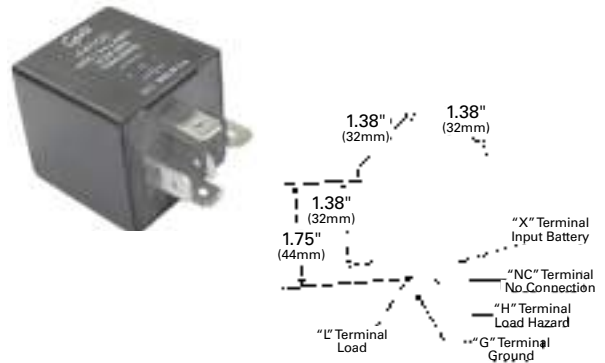

## 10-LAMP ELECTROMECHANICAL FLASHER

Molded base and terminals • Heavy-duty contacts • 60–120 flashes per minute

### 2 TERMINAL:

**44810** Flasher

**44810-5** Flasher **RETAIL**

### 3 TERMINAL (PILOT):

**44820** Flasher

**Regulations / Standards:** FMVSS 108 / SAE J945™, J590™  
**Volts / Amp:** 12V / 2–20A; Lamp Load: 1–10 lamps  
**VMRS Code:** 034-003-018

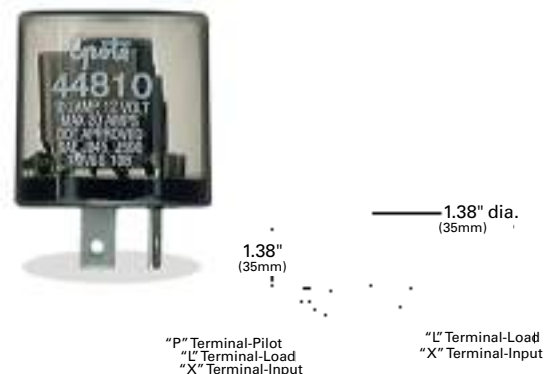



1.13" (29mm) sq.

1.5" (38mm)

"X" Terminal-Input  
"L" Terminal-Load  
"P" Terminal-Pilot

1.13" (29mm) sq.

1.5" (38mm)

"L" Terminal-Load  
"X" Terminal-Input

## 12-LAMP ELECTROMECHANICAL FLASHER

60–120 flashes per minute • Available in standard 12-Volt and 24-Volt models • Less than 4mV per amp voltage drop • Exceeds SAE 100-hour test • Fits in a round flasher socket

### 2 TERMINAL:

44530 Flasher  
44530-5 Flasher **RETAIL**  
44850 Flasher **24 VOLT**

### 3 TERMINAL (PILOT):

44540 Flasher  
44860 Flasher **24 VOLT**

**Regulations / Standards:** FMVSS 108 / SAE J945™, J590™

**Volts / Amp:** 12V / 2–25A; Lamp Load: 1–12 lamps

**VMRS Code:** 034-003-018

1.13" sq. (29mm)

1.7" (44)

"L" Terminal-Load  
"X" Terminal-Input  
"X" Terminal-Input  
"P" Terminal-Pilot

"L" Terminal-Load



## 16-LAMP ELECTRONIC FLASHER

60–120 flashes per minute • 11–15-Volts DC • Less than 4mV per amp voltage drop • Exceeds SAE 100-hour test • Fits in a round flasher socket

### 2 TERMINAL:

44690 Flasher

### 3 TERMINAL (PILOT):

44700 Flasher

**Regulations / Standards:** FMVSS 108 / SAE J945™, J590™

**Volts / Amp:** 12V / 2–33A; Lamp Load: 1–16 lamps

**VMRS Code:** 034-003-018

1.75" (44mm)

1.13" (29mm) sq.

1.75" (44mm)

"L" Terminal-Load  
"X" Terminal-Input"X" Terminal-Input  
"L" Terminal-Load  
"P" Terminal-Pilot

## 20-LAMP HEAVY DUTY ELECTRONIC FLASHER

60–120 flashes per minute • 11–15-Volts DC • Less than 3mV per amp voltage drop • Fits standard round socket • Exceeds SAE 100-hour test

### 2 TERMINAL:

44710 Flasher

### 3 TERMINAL:

44720 Flasher

**Regulations / Standards:** FMVSS 108; SAE J945, J590

**Volts / Amp:** 12V / 2–42A; Lamp Load: 1–20 lamps

**VMRS Code:** 034-003-018

1.13" (29mm) sq.

1.75" (44mm)

"X" Terminal-Input  
"G" Terminal-Ground  
"L" Terminal-Load

## NORTH AMERICAN (J50) PINOUT

Heavy-duty contacts • Flash rate electronically timed • Fits most Dodge®, Ford®, Honda®, Mitsubishi®, Nissan®, and Subaru® vehicles (see application guide) • Steady flash rate for all incandescent and LED leads

### 3 TERMINAL:

44892 Flasher

**Regulations / Standards:** FMVSS 108 / SAE J945™, J590™

**Volts / Amp:** 12V / 1–20A; Lamp Load: 1–10 Lamps

**VMRS Code:** 034-003-018

### 6-LAMP HEAVY-DUTY ALTERNATING ELECTRONIC FLASHER

11–15-Volts DC • Less than 4mV per amp voltage drop

**3 TERMINAL:**

**44730** Flasher

**Regulations / Standards:** FMVSS 108 / SAE J945™, J590™  
**Volts / Amp:** 12V / 25A; Lamp Load: 1–10 lamps  
**VMRS Code:** 034-003-018



"X" Terminal-Input  
"L" Terminal-Load  
"L" Terminal-Load

### NON-LATCHING HEADLAMP DIMMER RELAY

Used for converting from floor-mounted dimmer switch to turn signal switch with lift-to-dim feature • Heavy-duty contact design provides years of trouble-free operation

**44460** Relay

**Volts / Amp:** 12V / 20–30A capacity  
**VMRS Code:** 034-003-018



### 24 TO 12 VOLT CONVERTER

Allows use of 12-Volt lighting/accessories on 24-Volt vehicles • Rugged die-cast housing • Solid-state, fully potted electronics

**44070** Converter **MULTI**

**Material:** Aluminum  
**Finish:** Bright  
**Volts / Amp:** 18–32V input, 13.8V output / 3A max  
**VMRS Code:** 034-003-018

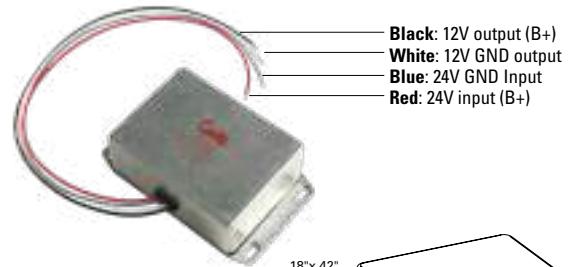

**Black:** 12V output (B+)  
**White:** 12V GND output  
**Blue:** 24V GND Input  
**Red:** 24V input (B+)

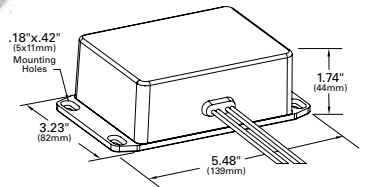

### SOLID-STATE ELECTRONIC FLASHER

Designed for use with LED lighting • Provides steady flash rate over any load up to 12 amps • Fully-potted, solid-state electronics • Self-resetting feature provides internal protection against short circuits

**44010** 3-Wire **MULTI**

**44030** Alternating Flasher **MULTI**

**Material:** Aluminum  
**Finish:** Black  
**Regulations / Standards:** FMVSS 108 / SAE J945™, J590™  
**Volts / Amp:** 12–24V / 12A max (44030: 6A per side)  
**VMRS Code:** 034-003-018



**Black:** GND  
**Red:** B+ (+12 or +24)  
**Green:** Load Positive

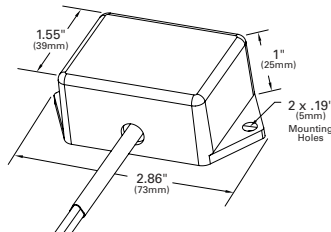
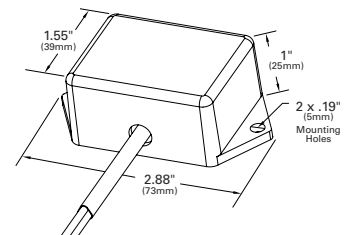

**Black:** GND  
**Red:** B+ (+12 or +24)  
**Green:** Load 1  
**Green:** Load 2

**44030**

## FLASHER APPLICATION GUIDE

Variable-load flashers may not have lamp outage indicators and may continue to flash at a normal rate even though one or more bulbs have failed. Inspect your lighting system frequently and replace any burned-out bulbs immediately. These flashers are designed for heavy-duty or trailer load applications.

### Acura®

| Year      | Vehicle / Model | Exceptions  | Part  |
|-----------|-----------------|-------------|-------|
| 1991-1986 | Legend          |             | 44810 |
| 1997-1986 | All others      | CL, NSX, RL | 44892 |

### AMC®

| Year      | Vehicle / Model | Exceptions | Part  |
|-----------|-----------------|------------|-------|
| 1988-1975 | All             |            | 44810 |

### BMW®

| Year      | Vehicle / Model | Exceptions | Part  |
|-----------|-----------------|------------|-------|
| 1974-1976 | All             |            | 44820 |

### Buick®

| Year      | Vehicle / Model | Exceptions | Part  |
|-----------|-----------------|------------|-------|
| 1996-1992 | Century         |            | 44810 |
| 1990-1985 | Electra         |            | 44810 |
| 1997      | LeSabre         |            | 44810 |
| 1997      | Riviera         |            | 44810 |

### Cadillac®

| Year      | Vehicle / Model | Exceptions                        | Part  |
|-----------|-----------------|-----------------------------------|-------|
| 1993-1970 | All             | Allante, 1993 El Dorado and older | 44810 |
| 1997-1994 | All             | others below                      | 44892 |
| 1999-1989 | Seville and STS | 1990 Seville                      | 44892 |
| 1997-1994 | Catera          |                                   | 44810 |
| 1997-1994 | Fleetwood       |                                   | 44810 |
| 1996-1970 | All             | 1996 Skylark                      | 44810 |

### Chevrolet® / GMC®

| Year      | Vehicle / Model                            | Exceptions            | Part  |
|-----------|--|-----------------------|-------|
| Pre-1997  | 2-Terminal Flasher                         | others if noted below | 44810 |
| Pre-1993  | 3-Terminal Flasher, Commercial Trucks Only |                       | 44540 |
| 1988-1987 | Spectrum                                   |                       | 44892 |
| 1988-1987 | Sprint                                     |                       | 44892 |
| 1993-1992 | Vans with tow package                      |                       | 44530 |

### Chrysler®

| Year | Vehicle / Model    | Exceptions | Part  |
|------|--------------------|------------|-------|
|      | 2-Terminal Flasher |            | 44810 |
|      | 5-Terminal Flasher |            | 44090 |

### Daihatsu®

| Year      | Vehicle / Model | Exceptions | Part  |
|-----------|-----------------|------------|-------|
| 1992-1984 | All             | Rocky      | 44892 |

### Dodge®

| Year      | Vehicle / Model    | Exceptions                                    | Part  |
|-----------|--------------------|---|-------|
|           | 2-Terminal Flasher | others noted below                            | 44810 |
| 1995-1970 | All Cars           | Monaco, Raider, 1985 Ram Van Wagon and Pickup | 44810 |
| 1996-1986 | Colt               |   | 44892 |
| 1993-1983 | Ram 50             |   | 44892 |
| 1996-1986 | Stealth            |   | 44892 |

### Eagle®

| Year      | Vehicle / Model | Exceptions | Part  |
|-----------|-----------------|------------|-------|
| 1989-1988 | Medallion       |            | 44820 |
| 1996-1994 | Summit          |            | 44892 |
| 1996-1992 | Summit Wagon    |            | 44892 |
| 1993-1990 | Talon           |            | 44892 |

### Fiat®

| Year      | Vehicle / Model | Exceptions | Part  |
|-----------|-----------------|------------|-------|
| 1983-1970 | All             |            | 44820 |

### Ford®

| Year      | Vehicle / Model                            | Exceptions | Part  |
|-----------|--|------------|-------|
|           | 2-Terminal Flasher                         |            | 44810 |
| Pre-1993  | 3-Terminal Flasher, Commercial Trucks Only |            | 44540 |
|           | 3-Terminal Flasher                         |            | 44892 |
|           | 5-Terminal Flasher                         |            | 44090 |
| 1997-1972 | E-Series Truck                             |            | 44530 |
| 1964      | Thunderbird                                |            | 44820 |

### GMC®

| Year      | Vehicle / Model | Exceptions | Part  |
|-----------|-----------------|------------|-------|
| 1991-1978 | All             |            | 44810 |

### Geo

| Year      | Vehicle / Model | Exceptions | Part  |
|-----------|-----------------|------------|-------|
| 1996-1989 | Metro           |            | 44892 |
| 1989      | Spectrum        |            | 44892 |
| 1993-1990 | Storm           |            | 44892 |
| 1995-1989 | Tracker         |            | 44892 |

### Honda®

| Year      | Vehicle / Model    | Exceptions | Part  |
|-----------|--------------------|------------|-------|
|           | 2-Terminal Flasher |            | 44810 |
|           | 3-Terminal Flasher |            | 44892 |
| 1981-1976 | Accord             |            | 44810 |

### Hyundai®

| Year      | Vehicle / Model | Exceptions | Part  |
|-----------|-----------------|------------|-------|
| 1995-1989 | All             |            | 44892 |

### Infiniti®

| Year      | Vehicle / Model | Exceptions | Part  |
|-----------|-----------------|------------|-------|
| 1996-1990 | All             | 1996 I30   | 44892 |

### International®

| Year      | Vehicle / Model | Exceptions | Part  |
|-----------|-----------------|------------|-------|
| 1980-1974 | All             |            | 44810 |

### Isuzu®

| Year      | Vehicle / Model | Exceptions | Part  |
|-----------|-----------------|------------|-------|
| 2004-1987 | All             |            | 44892 |

### Jaguar®

| Year      | Vehicle / Model | Exceptions | Part  |
|-----------|-----------------|------------|-------|
| 1996-1978 | XJ6, XJS, XJ12  |            | 44820 |
| 1989-1986 | XJ6, XJS        |            | 44892 |

### Jeep®

| Year      | Vehicle / Model | Exceptions   | Part  |
|-----------|-----------------|--|-------|
| 1997-1994 | Grand Cherokee  |  | 44090 |
| 1996-1978 | All             | 1993 Grand Wagoneer, 1996 Grand Cherokee, 1986 CJ and Scramble | 44810 |

| <b>Lincoln®</b> |                    |            |       |
|-----------------|--------------------|------------|-------|
| Year            | Vehicle / Model    | Exceptions | Part  |
|                 | 2-Terminal Flasher |            | 44810 |
|                 | 3-Terminal Flasher |            | 44892 |
|                 | 5-Terminal Flasher |            | 44090 |

| <b>Mazda®</b> |                 |            |       |
|---------------|-----------------|------------|-------|
| Year          | Vehicle / Model | Exceptions | Part  |
| 1984-1971     | 2-Pin           |            | 44180 |

| <b>Mercury®</b> |                    |            |       |
|-----------------|--------------------|------------|-------|
| Year            | Vehicle / Model    | Exceptions | Part  |
|                 | 2-Terminal Flasher |            | 44810 |
|                 | 3-Terminal Flasher |            | 44892 |
|                 | 5-Terminal Flasher |            | 44090 |

| <b>Mitsubishi®</b> |                    |                    |       |
|--------------------|--------------------|--------------------|-------|
| Year               | Vehicle / Model    | Exceptions         | Part  |
|                    | 2-Terminal Flasher |                    | 44810 |
|                    | 3-Terminal Flasher | others noted below | 44892 |

| <b>Nissan®</b> |                    |            |       |
|----------------|--------------------|------------|-------|
| Year           | Vehicle / Model    | Exceptions | Part  |
|                | 2-Terminal Flasher |            | 44810 |
|                | 3-Terminal Flasher |            | 44892 |

| <b>Oldsmobile®</b> |                    |            |       |
|--------------------|--------------------|------------|-------|
| Year               | Vehicle / Model    | Exceptions | Part  |
|                    | 2-Terminal Flasher |            | 44810 |
|                    | 5-Terminal         |            | 44090 |

| <b>Peugeot®</b> |                 |            |       |
|-----------------|-----------------|------------|-------|
| Year            | Vehicle / Model | Exceptions | Part  |
| 1991-1982       | All             |            | 44820 |

| <b>Plymouth®</b> |                 |            |       |
|------------------|-----------------|------------|-------|
| Year             | Vehicle / Model | Exceptions | Part  |
| 1991-1975        | All             |            | 44810 |

| <b>Pontiac®</b> |                    |            |       |
|-----------------|--------------------|------------|-------|
| Year            | Vehicle / Model    | Exceptions | Part  |
|                 | 2-Terminal Flasher |            | 44810 |
|                 | 5-Terminal         |            | 44090 |
| 1991-1989       | LeMans             |            | 44892 |

| <b>Porsche®</b> |                      |                    |       |
|-----------------|----------------------|--------------------|-------|
| Year            | Vehicle / Model      | Exceptions         | Part  |
|                 | 2-Terminal Flasher   | others noted below | 44810 |
| 1986-1978       | 924 (Hazard Flasher) |                    | 44820 |
| 1982-1978       | 928 (Hazard Flasher) |                    | 44820 |
| 1986-1978       | 944 (Hazard Flasher) |                    | 44820 |

| <b>Renault®</b> |                      |            |       |
|-----------------|----------------------|------------|-------|
| Year            | Vehicle / Model      | Exceptions | Part  |
| 1986-1983       | 2 Pin                |            | 44810 |
| 1986-1983       | 3 Pin                |            | 44820 |
| 1980-1978       | All (Hazard Flasher) |            | 44820 |
| 1985-1982       | Alliance             |            | 44810 |
| 1985-1984       | Encore               |            | 44810 |
| 1985-1982       | Fuego                |            | 44820 |

| <b>SAAB®</b> |                 |            |       |
|--------------|-----------------|------------|-------|
| Year         | Vehicle / Model | Exceptions | Part  |
| 1980-1978    | 99 and 99GL     |            | 44892 |
| 1981         | 900             |            | 44892 |
| 1999         | Sonett          |            | 44820 |
| 1975-1974    | All             |            | 44820 |

| <b>Subaru®</b> |                    |            |       |
|----------------|--------------------|------------|-------|
| Year           | Vehicle / Model    | Exceptions | Part  |
|                | 2-Terminal Flasher |            | 44810 |
|                | 3-Terminal Flasher |            | 44892 |

| <b>Suzuki®</b> |                 |            |       |
|----------------|-----------------|------------|-------|
| Year           | Vehicle / Model | Exceptions | Part  |
|                | All             |            | 44892 |

| <b>Toyota®</b> |                 |            |       |
|----------------|-----------------|------------|-------|
| Year           | Vehicle / Model | Exceptions | Part  |
| 1980-1978      | Cresida         |            | 44892 |
| 1980-1978      | Land Cruiser    |            | 44810 |
| 1997           | Previa          |            | 44892 |

| <b>Triumph®</b> |                      |            |       |
|-----------------|----------------------|------------|-------|
| Year            | Vehicle / Model      | Exceptions | Part  |
| 1982-1970       | All (Turn Flasher)   |            | 44810 |
| 1982-1970       | All (Hazard Flasher) | 44820      |       |

| <b>Yugo®</b> |                 |            |       |
|--------------|-----------------|------------|-------|
| Year         | Vehicle / Model | Exceptions | Part  |
|              | All             |            | 44820 |

## UNIVERSAL 7-WIRE / 4-WIRE TURN SIGNAL SWITCH KIT



Replaces Truck-Lite® and Signal-Stat® 900-902, 920 and 2900-3 • Includes switch, mounting hardware and 24" blunt-cut harness • 4- or 7-wire system • Adapts to applications without brake override functions • For applications with floor-mounted dimmer switch • 18-bulb capacity makes switch ideal for triple trailer configurations • Compatible with 24-Volt systems if indicator bulb is replaced with Grote's 24V bulb (1450) • Mounting hardware kit includes threaded inserts with screws for mounting to existing brackets and a worm gear clamp with a range of 1.6" to 2.5" for mounting to circular column tubes

**48072** Turn Signal Switch Kit

**Regulations / Standards:** FMVSS 108 / SAE Q

**Finish:** Black

**Bulb:** (Indicator) 53, 1 CP

**Voltage/Amp:** 12V / .12A

**Accessory:** Switch: 48272; Harness: 69680

**VMRS Code:** 034-003-016

## UNIVERSAL TURN SIGNAL SWITCH



Universal replacement without high-low beam function • 18-bulb capacity makes switch ideal for triple-trailer configurations • Mounting hardware kit includes tapped inserts with screws for mounting to existing brackets and a worm gear clamp with a range of 1"–2.5" for mounting to circular column trucks • Integral RH and LH turn/hazard indicator lights • Adapts to applications without brake override functions • Compatible with 24-Volt systems if indicator bulb is replaced with Grote's 24V bulb (1450)

**48272** Turn Signal Switch

**Regulations / Standards:** FMVSS 108 / SAE Q

**Finish:** Black

**Bulb:** (Indicator) 53, 1 CP; Voltage/Amp: 12V / .12A

**Accessory:** Harness: 69680

**VMRS Code:** 034-003-016

## UNIVERSAL TURN SIGNAL SWITCH WITH LIFT-TO-DIM



18-bulb capacity makes switch ideal for triple-trailer configurations • Mounting hardware kit includes tapped inserts with screws for mounting to existing brackets and a worm gear clamp with a range of 1"–2.5" for mounting to circular column trucks • Adapts to applications without brake override functions

**48282** Universal Turn Signal Switch

**Regulations / Standards:** FMVSS 108 / SAE Q

**Finish:** Black

**Accessory:** Harness: 69690

**VMRS Code:** 034-003-016



### **UNIVERSAL REPLACEMENT HARNESS**

Fits 48272 switch • Overall length of 24" is sufficient for most applications  
 • Flexible, black PVC loom adds protection without adding rigidity • 4- to 7-wire system compatible • Includes circuitry for switches with integral RH and LH turn/hazard indicator light

**69680** Universal Harness

**VMRS Code:** 034-003-016



### **UNIVERSAL PLUG-IN WIRING HARNESS WITH LIFT-TO-DIM**

Fits 48282 switch • Includes 44460 non-latching relay • Includes connector for headlamp relay • 4- to 7-wire system compatible • Overall length of 24" is sufficient for most applications • Flexible, black PVC loom adds protection without adding rigidity

**69690** Universal Harness

**VMRS Code:** 034-003-016



### **FREIGHTLINER® AND KENWORTH® OEM REPLACEMENT SWITCH WITH HARNESS**

Replaces Freightliner® GRO 01-4811-87, Grote® 01-4811-87, and Paccar® K301-295-3 • Black worm gear mounting clamp included • OEM-style, 20" plug-in wiring harness included • 18-bulb capacity makes switch ideal for triple-trailer configurations

**48532** Turn Signal Switch Kit

**Regulations / Standards:** FMVSS 108 / SAE Q

**Finish:** Black

**VMRS Code:** 034-003-016



### **FREIGHTLINER® OEM REPLACEMENT SWITCH**

Replaces Freightliner® GRO 01-4811-77 • 18-bulb capacity makes switch ideal for triple-trailer configurations • Plugs into OE harness on truck  
 • Mounts with a separate worm gear clamp

**48522** Turn Signal Switch Kit

**Regulations / Standards:** FMVSS 108 / SAE Q

**Finish:** Black

**VMRS Code:** 034-003-016





### OEM-STYLE TURN SIGNAL SWITCH

Replaces Freightliner® GRO 01-4813-80 and GRO 01-4813-81 • 18-bulb capacity makes switch ideal for triple-trailer configurations • Mounting bracket included

**48552** Turn Signal Switch

**Regulations / Standards:** FMVSS 108 / SAE Q

**Finish:** Black

**VMRS Code:** 034-003-016



### OEM-STYLE TURN SIGNAL SWITCH FOR PACCAR®

Replaces PACCAR® 01-4813-91, TRW® 480819 without harness • 18-bulb capacity makes switch ideal for triple-trailer configurations • Adapts to applications without brake override function • Provides hazard/warning, right/left turn, lift-to-dim functions

**48132** Turn Signal Switch

**Regulations / Standards:** FMVSS 108 / SAE Q

**Finish:** Black

**VMRS Code:** 034-003-016

Kenworth® is a registered trademark of PACCAR, Inc.; Freightliner® is a registered trademark of Daimler Trucks North America, LLC; Jeep® is a registered trademark of FCS US LLC; Chevrolet® is a registered trademark of General Motors LLC; GMC® is a registered trademark of General Motors LLC; Dodge® is a registered trademark of FCA US LLC; Fiat® is a registered trademark of FCA Marketing Group S.P.A.; Honda® is a registered trademark of Honda Motor Company, Ltd.; Acura® is a registered trademark of Honda Motor Company, Ltd.; AMC® is a registered trademark of FCA US LLC; BMW® is a registered trademark of Bayerische Motoren Werke Aktiengesellschaft; Buick® is a registered trademark of General Motors LLC; Cadillac® is a registered trademark of General Motors LLC; Chrysler® is a registered trademark of FCA US LLC; Daihatsu® is a registered trademark of Daihatsu Motor Co. Ltd.; Hyundai® is a registered trademark of Hyundai Motor Company; Ford® is a registered trademark of Ford Motor Company CORPORATION DELAWARE; Infiniti® is a registered trademark of NISSAN JIDOSHA KABUSHIKI KAISHA.; International® is a registered trademark of International Truck Intellectual Property; Isuzu® is a registered trademark of ISUZU JIDOSHA KABUSHIKI KAISHA. Jaguar® is a registered trademark of JAGUAR LAND ROVER LIMITED. Lincoln® is a registered trademark of FORD MOTOR COMPANY. Mazda® is a registered trademark of MAZDA MOTOR CORPORATION. Mitsubishi® is a registered trademark

of MITSUBISHI JUKOGYO KABUSHIKI KAISHA. Mercury® is a registered trademark of FORD MOTOR COMPANY. Nissan® is a registered trademark of NISSAN JIDOSHA KABUSHIKI KAISHA. Plymouth® is a registered trademark of FCA US LLC; Pontiac® is a registered trademark of GENERAL MOTORS LLC; Porsche® is a registered trademark of Dr. Ing. h.c. F. Porsche Aktiengesellschaft; Renault® is a registered trademark of RENAULT s.a.s.; SAAB® is a registered trademark of SAAB AB; Subaru® is a registered trademark of FUJI JUKOGYO KABUSHIKI KAISHA.; Suzuki® is a registered trademark of SUZUKI MOTOR CORPORATION.; Toyota® is a registered trademark of Toyota Jidosha Kabushiki Kaisha.; Yugo® is a registered trademark of OTP LLC.; Truck-Lite® is a registered trademark of TRUCK-LITE CO. Signal-Stat® is a registered trademark of TRUCK-LITE CO., LLC; International® is a registered trademark of International Truck Intellectual Property; Paccar® is a registered trademark of PACCAR Inc. Peugeot® is a registered trademark of AUTOMOBILES PEUGEOT société anonyme sa; Eagle®; Oldsmobile®; Triumph®

All product and company names are trademarks™ or registered® trademarks of their respective holders. Use of them does not imply any affiliation with or endorsement by them.

**OEM-STYLE TURN SIGNAL SWITCH FOR INTERNATIONAL®**

Replaces International® 354493C92 without harness • 18-bulb capacity makes switch ideal for triple-trailer configurations • Adapts to applications without brake override function • Provides hazard/warning, left/right turn, lift-to-dim functions

**48283** Turn Signal Switch

**Regulations / Standards:** FMVSS 108 / SAE Q  
**Finish:** Black  
**VMRS Code:** 034-003-016



**OEM-STYLE MARKER / FLASH AND WIPER TURN SIGNAL SWITCH FOR INTERNATIONAL®**

Replaces International® 2004505C91 without harness • 18-bulb capacity makes switch ideal for triple-trailer configurations • Adapts to applications without brake override function • Provides hazard/warning, left/right turn, lift-to-dim functions • Mounting hardware kit includes tapped inserts with screws for mounting to existing brackets and a worm gear clamp with a range of 1"–2.5" for mounting to round columns • Chrome-plated end push-button for flashing marker lamps • Slide switch for 2-speed wiper control

**48442** Turn Signal Switch

**Regulations / Standards:** FMVSS 108 / SAE Q  
**Finish:** Black  
**VMRS Code:** 034-003-016



**NEED HELP FINDING THE RIGHT PRODUCT?**

GROTE® CUSTOMER SERVICE IS JUST A PHONE CALL AWAY

**800-628-0809**



# 11

## MIRRORS

*RÉTROVISEURS*

*ESPEJOS*



## WEST COAST MIRRORS

Whether you reside near the Pacific, Atlantic, or any place in between, West Coast Mirrors give you maximum visibility. Don't let the name confuse you—if you need enhanced rear view capability, are looking for retro-styling, or making an OEM-quality repair or replacement—premium Grote® West Coast mirrors will do the trick. Pick the style, color, and features you need and you will be on your way.



16021



16023

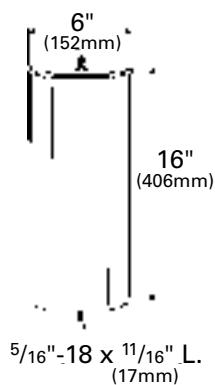

16244

### 6" X 16" WEST COAST MIRRORS

| Part Number | Description              | Back Style | Back Color      | Reflective Area | Housing Material | Regulations / Standards |
|-------------|--------------------------|------------|-----------------|-----------------|------------------|-------------------------|
| 16021       | OEM Style, Powder-Coated | Angle      | White           | 101 Sq. In.     | Steel            | FMVSS 111, 10,000+ lbs  |
| 16023       | OEM Style, Powder-Coated | Angle      | Stainless Steel | 101 Sq. In.     | Steel            | FMVSS 111, 10,000+ lbs  |

VMRS Code: 002-010-006



## WEST COAST MIRRORS

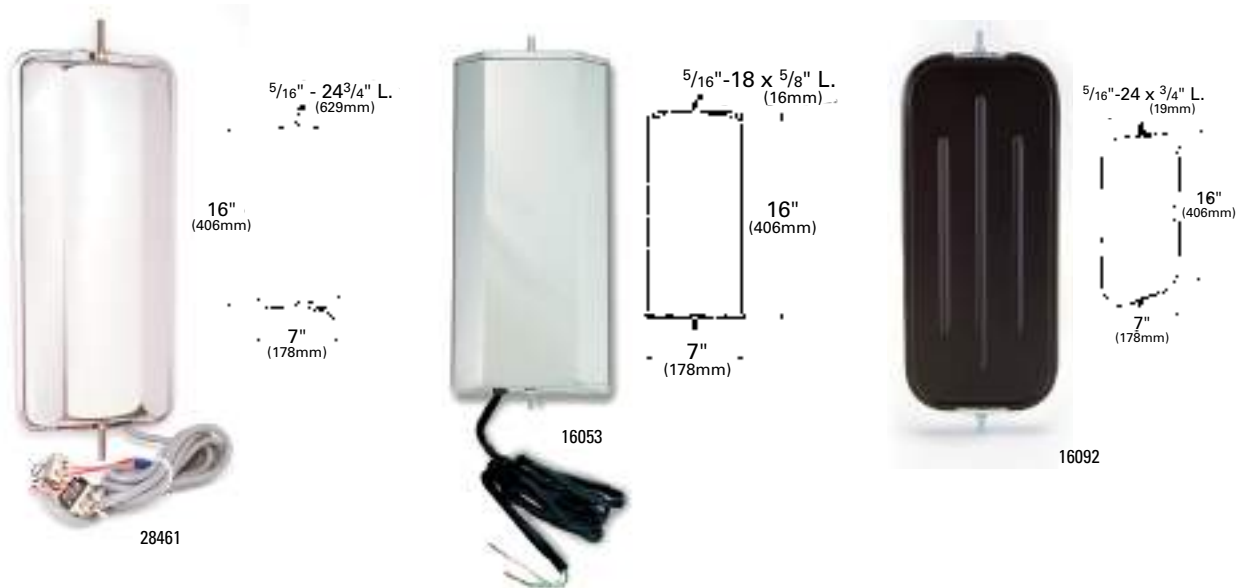

### 7" X 16" WEST COAST HEATED MIRRORS

| Part Number | Description                       | Back Style | Back Color      | Reflective Area | Housing Material | Volts / Amps | Regulations / Standards |
|-------------|-----------------------------------|------------|-----------------|-----------------|------------------|--------------|-------------------------|
| 28461       | Remote Control, Heated, Motorized | Angle      | Stainless Steel | 94 Sq. In.      | Steel            | 12V/3.1A     | FMVSS 111, 10,000+ lbs  |
| 28463       | Remote Control, Heated            | Angle      | Stainless Steel | 94 Sq. In.      | Steel            | 12V/3.1A     | FMVSS 111, 10,000+ lbs  |
| 16053       | OEM Style, Heated                 | Angle      | Stainless Steel | 101 Sq. In.     | Steel            | 12V/3.1A     | FMVSS 111, 10,000+ lbs  |
| 16153       | OEM Style, Pyramid                | Peak       | Stainless Steel | 101 Sq. In.     | Steel            | 12V/1.25A    | FMVSS 111, 10,000+ lbs  |

### 7" X 16" WEST COAST MIRRORS

| Part Number | Description                  | Back Style | Back Color      | Reflective Area        | Housing Material | Regulations / Standards |
|-------------|------------------------------|------------|-----------------|------------------------|------------------|-------------------------|
| 16091       | OEM Style, Powder-Coated     | Ribbed     | White           | 93 Sq. In.             | Steel            | FMVSS 111, 10,000+ lbs  |
| 16092       | OEM Style, Powder-Coated     | Ribbed     | Black           | 93 Sq. In.             | Steel            | FMVSS 111, 10,000+ lbs  |
| 16093       | OEM Style, Natural Finish    | Ribbed     | Stainless Steel | 93 Sq. In.             | Steel            | FMVSS 111, 10,000+ lbs  |
| 26001-5     | OEM Style, with Arm Assembly | Ribbed     | White           | 93 Sq. In.             | Steel            | FMVSS 111, 10,000+ lbs  |
| 16041       | Split Focus with Adj. Convex | Angle      | White Enamel    | 57 Sq. In. /20 Sq. In. | Steel            | FMVSS 111, 10,000+ lbs  |
| 16043       | Split Focus with Adj. Convex | Angle      | Stainless Steel | 57 Sq. In. /20 Sq. In. | Steel            | FMVSS 111, 10,000+ lbs  |
| 16123       | OEM Style, Powder-Coated     | Angle      | Stainless Steel | 101 Sq. In.            | Steel            | FMVSS 111, 10,000+ lbs  |
| 16202       | Economy, Warp Proof          | Angle      | Black           | 95 Sq. In.             | Polypropylene    | FMVSS 111, 10,000+ lbs  |
| 16244       | Economy, Aluminum            | Angle      | Metallic        | 87 Sq. In.             | Aluminum         |                         |
| 16284       | Navistar® OEM Replacment     | Flat       | Metallic        | 101 Sq. In.            | Aluminum         | FMVSS 111, 10,000+ lbs  |
| 16273       | OEM Style, Pyramid           | Peak       | Stainless Steel | 101 Sq. In.            | Steel            | FMVSS 111, 10,000+ lbs  |
| 16101       | OEM Style, Powder-Coated     | Bubble     | White           | 93 Sq. In.             | Steel            | FMVSS 111, 10,000+ lbs  |
| 16102       | OEM Style, Powder-Coated     | Bubble     | Black           | 93 Sq. In.             | Steel            | FMVSS 111, 10,000+ lbs  |

VMRS Code: 002-010-006

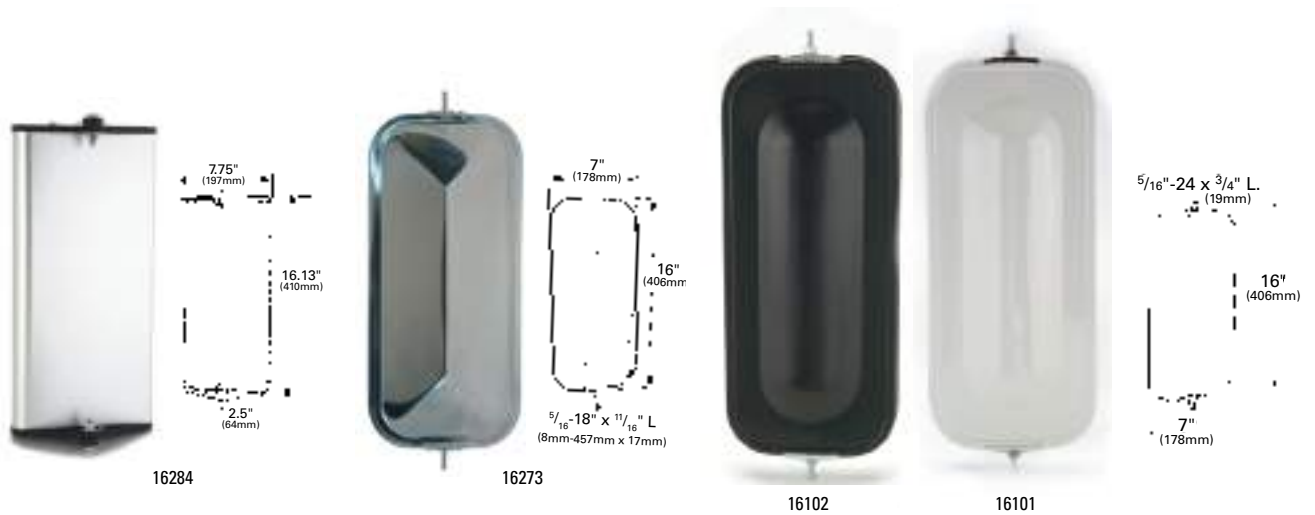
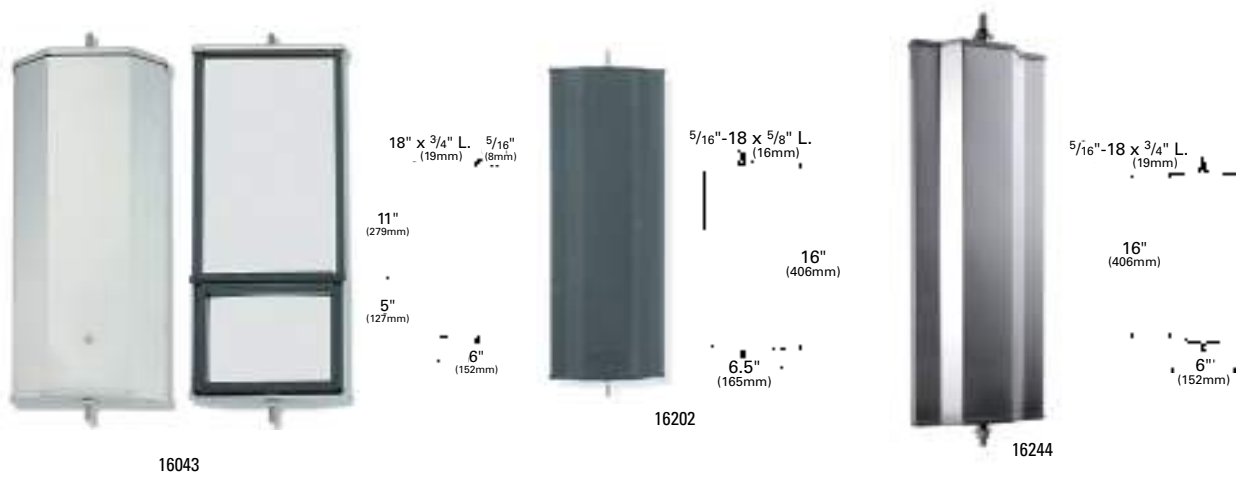

## WEST COAST MIRROR ACCESSORIES



### WEST COAST MIRROR BRACKET ASSEMBLY

22013 Stainless Steel

**Material:** Stainless Steel



### C-LOOP BRACKET

22233 Stainless Steel

**Material:** Stainless Steel

**Finish:** Stainless Steel



### WEST COAST HEATING ELEMENT REPLACEMENT

29060 Element

**Material:** Adhesive Black Heated Board  
**Volts / Amps:** 12V / 3.1 AMP

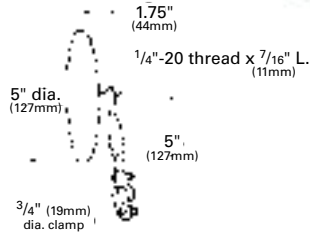

28033

### 5" ROUND CLAMP-ON SPOT MIRROR

Provides wider vision • Includes arm and clamp to attach securely to mirror arm • Single-strength silvered mirror

#### 5" CONVEX:

**28032** Black, Powder-Coated, w/ Arm Assembly

**28033** Stainless Steel, w/ Arm Assembly

**28033-5** Stainless Steel, w/ Arm Assembly

#### 5" FLAT GLASS:

**28162** Black, Powder-Coated, w/ Arm Assembly

**28152** Black w/ "L" Bracket

**Material:** Stainless Steel, Steel

**FMVSS:** 111 Vehicles with GVWR greater than 10,000 lbs.

**Reflective:** 20 sq. in.

**Finish:** Stainless, Black

**Accessory:** Extension Arm: 10073

**VMRS Code:** 002-010-026 - 28032, 28033, 28033-5, 28152  
 002-010-006 - 28162

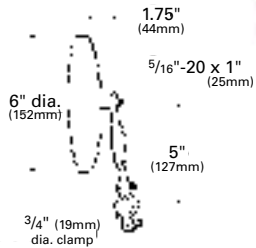

28663

### 6" CONVEX CENTER-MOUNT SPOT MIRROR

Features stainless steel construction and adjustable ball swivel

• Available with or without "L" bracket

#### MIRROR HEAD ONLY

**12053** Stainless Steel

**12052** Black

#### MIRROR HEAD AND "L" BRACKET

**28663** Stainless Steel

#### MIRROR HEAD AND ARM ASSEMBLY

**28042** Black, Powder-Coated

**28043** Stainless Steel

**Material:** Stainless Steel, Steel

**FMVSS:** 111 Vehicles with GVWR greater than 10,000 lbs.

**Reflective:** 28 sq. in.

**Finish:** Stainless, Black

**Accessory:** Arm Assembly: 10173 (with "L" Bracket)

**Bracket:** 11303 ("L" Bracket Only); 10073 (Arm Assembly Only)

**VMRS Code:** 002-010-026 - 12053, 28663, 28042, 28043  
 002-010-008 - 12052

### 8" ROUND CONVEX MIRROR WITH CENTER-MOUNT BALL-STUD

Three-screw stud tightens firmly • 1/4" UNC female ball stud • Painted mirrors feature rugged powder-coat finish • Heated mirror includes 60" two-conductor jacketed blunt-cut cable and adhesive heater board (12283)

- 12182 Black
- 12183 Stainless Steel
- 12293 Stainless Steel with Attached "L" Bracket

**HEATED MIRROR:**

- 12283 Stainless Steel

**PLASTIC HOUSING:**

- 12983 Chrome

**Material:** Stainless Steel / Steel / Polypropylene

**Reflective:** 46.7 sq. in.

**Finish:** Stainless, Black, Chrome

**Volts / Amps:** 12V / 1.18A

**Bracket:** 11133

**VMRS Code:** 002-010-026



12283



### 8" ROUND CONVEX MIRROR WITH OFFSET BALL-STUD

Easy mounting in tight installations • Ball-stud offset 2" from center • Heated mirror includes 60" two-conductor jacketed blunt-cut cable and adhesive heater board (12813)

- 12172 Black, Powder-Coated
- 12173 Stainless Steel

**HEATED MIRROR:**

- 12813 Stainless Steel

**Material:** Stainless Steel / Steel

**Reflective:** 46 sq. in.

**Finish:** Stainless, Black

**Volts / Amps:** 12V / 1.18A

**VMRS Code:** 002-010-026 - 12172, 12173  
002-010-037 - 12813



12172

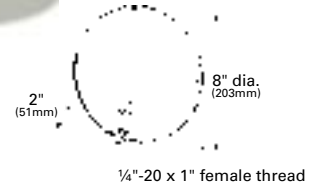

### 8 1/2" CONVEX MIRROR WITH CENTER-MOUNT, BALL-STUD

Adjustable ball stud mounting • Single-strength, silvered mirror • Includes "L" Bracket

- 16033 Stainless Steel
- 16032 Black

**PLASTIC HOUSING:**

- 12983 Chrome

**Material:** Stainless Steel / Steel/Polypropylene

**Reflective:** 56 sq. in.

**Finish:** Stainless, Black, Chrome

**Bracket:** 11303

**VMRS Code:** 002-010-026



16033

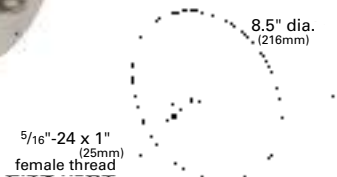

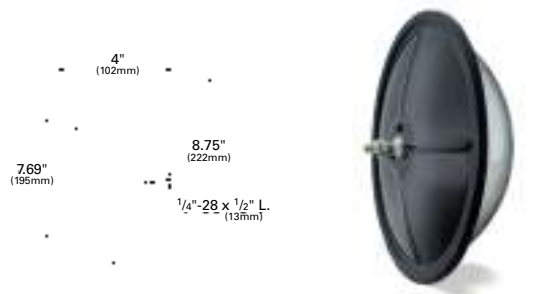

### 8" ELLIPTICAL MIRROR

Eliminates blind spots • Optimum crossover viewing  
• 4 1/4" radius x 7 11/16" dia.

**12272-5** Black, Mirror Head Only **RETAIL**

**Material:** Steel / Acrylic  
**Reflective:** 45 sq. in.  
**Finish:** Black  
**VMRS Code:** 002-010-026

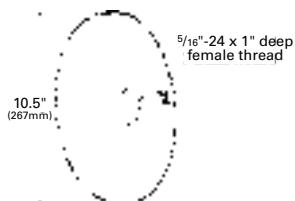

12010

### CONVEX MIRROR WITH CENTER MOUNT

Popular for highway service vehicles • Reinforced internal retainers  
• Large steel ball-stud for precise positioning • Replacement for 10 1/2" crossover mirrors

#### 10 1/2" CONVEX MIRROR:

**12010** Stainless Steel

#### 12" CONVEX MIRROR:

**12020** Gray, 3/8" - 24 11/16", Deep-Thread Ball-Stud

**Material:** Stainless Steel / Steel  
**Reflective:** 10 1/2" - 95 sq. in.; 12" - 135 sq. in.  
**Finish:** Stainless/Gray  
**VMRS Code:** 002-010-026

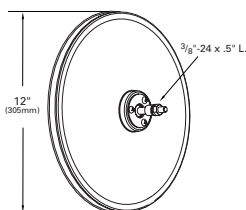

12020

### ADJUSTABLE MIRROR ASSEMBLY

Arm adjustable from 10" to 13" • Swivel bracket enables precise adjustment • Chrome arm and brackets

**28193** 6" Mirror (12053) and Adjustable Arm Assembly

#### ARM ASSEMBLY ONLY

**10433** Arm & Swivel Bracket Only

**Material:** Stainless Steel (12053), Steel (10433)  
**Reflective:** 26 sq. in.  
**Finish:** Stainless (mirror head) / Chrome (arm assembly)  
**VMRS Code:** 002-010-006 - 28193  
002-010-013 - 10433



28193

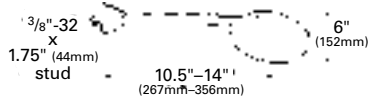

### CONVENTIONAL FENDER-MOUNT MIRROR

8" stainless steel convex mirror • Stainless steel brackets • Bell cup mounting for fiberglass fenders • Grote® 8" convex mirror (12182/3) will fit bracketry

**28443** Stainless Steel (Assembly Including Mirror)

#### ARM ASSEMBLY ONLY

**22193** Stainless Steel

#### MIRROR HEAD ONLY

**12183** Stainless Steel

**Material:** Stainless Steel  
**Reflective:** 46 sq. in.  
**Finish:** Stainless  
**VMRS Code:** 002-010-006 - 28443  
002-010-013 - 22193  
002-010-026 - 12183

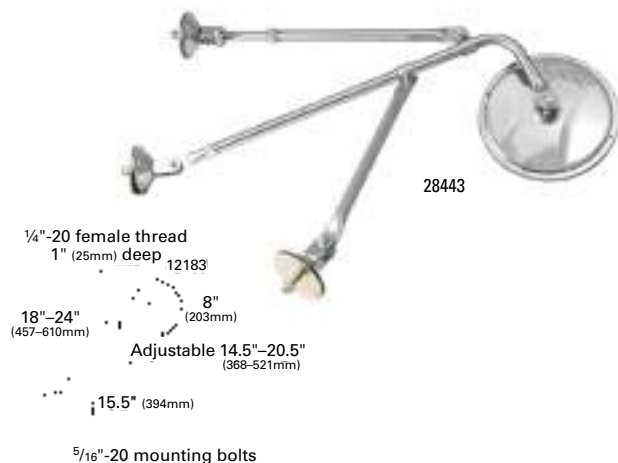

28443

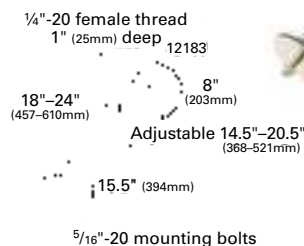



### SCHOOL BUS EXTERIOR BLIND SPOT MIRROR

Meets state laws for blind spot visibility • Zinc-plated bracketry  
• 8" convex mirror

**28063** Vertical-Mount Assembly, Stainless Steel  
**11195** Bracket Only w/o Mirror

**MIRROR HEAD ONLY**

**12183** Stainless Steel

**Material:** Stainless Steel, Steel

**Reflective:** 46 sq. in.

**Finish:** Stainless

**VMRS Code:** 002-010-006 - 28063

002-010-013 - 11195

002-010-026 - 12183



28063

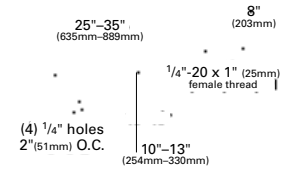

### 8 1/2" CONVEX CROSS-OVER MIRROR

Ideal for improving safety on straight trucks and delivery trucks

• Features rugged tripod mount for front or rear

**28481** White, Mirror Assembly

**Material:** Steel

**Reflective:** 56 sq. in.

**Finish:** White

**VMRS Code:** 002-010-026

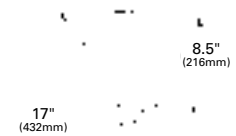

### HOOD-MOUNTED MIRROR

Bright stainless steel finish • Assembly comes with both a curved and straight extension for improved vision and range of application

• Kit includes backing plate, gasket, mounting hardware, and instructions  
• 8 1/2" convex stainless steel mirror head included

**12153** Stainless Steel

**Material:** Stainless Steel

**Reflective:** 56 sq. in.

**Finish:** Stainless

**VMRS Code:** 002-010-026

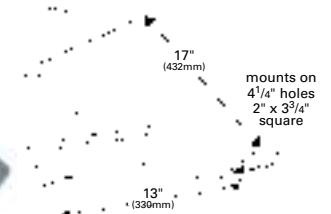

### 10 1/2" CONVEX CROSS-OVER MIRROR

Ideal for improving safety on straight trucks and delivery trucks • Features rigid 90° bracket

**28491** White, Mirror Assembly

**28493** Stainless Steel, Mirror Assembly

**Material:** Stainless Steel, Steel

**Reflective:** 95 sq. in.

**Finish:** Stainless / White

**VMRS Code:** 002-010-026



28493

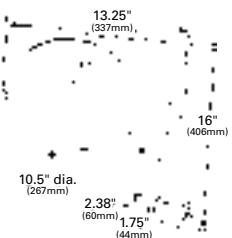



**SPLIT MIRROR**

Swing-away feature with detent • Fits right or left side • Top mirror is 6 1/2" x 10" flat glass • Bottom mirror is 6 1/2" x 6" convex

**28453** Stainless Steel

**REPLACEMENT 6 1/2" X 10" MIRRORS:**

**12301** White  
**12303** Stainless Steel

**REPLACEMENT 6 1/2" X 6" MIRRORS:**

**12331** White  
**12333** Stainless Steel

**Material:** Stainless Steel, Steel  
**Reflective:** 10" - 56 sq. in.; 6" - 33 sq. in.  
**Finish:** Stainless, White  
**VMRS Code:** 002-010-006 - 28453  
002-010-026 - 12301, 12303, 12331, 12333

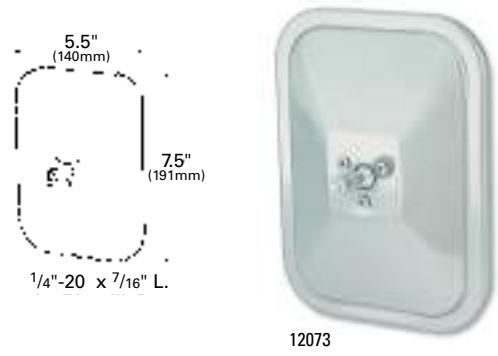

**ROLLED-RIM MIRROR WITH BALL SWIVEL**

1/4" - 20 x 7/16" ball swivel • Painted mirrors feature rugged powder-coated finish

**12071** White  
**12072** Black  
**12073** Stainless Steel  
**12073-5** Stainless Steel *RETAIL*

**Material:** Stainless Steel, Steel  
**Reflective:** 33 sq. in.  
**Finish:** Stainless, White, Black  
**VMRS Code:** 002-010-026

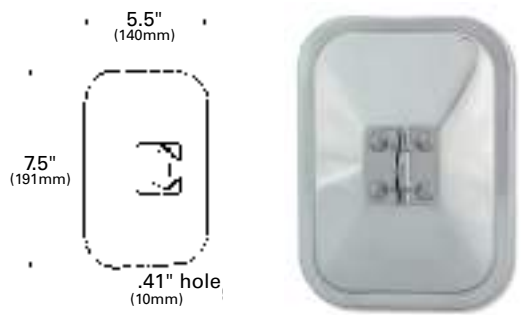

**ROLLED-RIM MIRROR WITH CENTER MOUNT**

Inner glass cushion

**12243-5** Stainless Steel *RETAIL*

**Material:** Stainless Steel  
**Reflective:** 33 sq. in.  
**Finish:** Stainless  
**VMRS Code:** 002-010-026

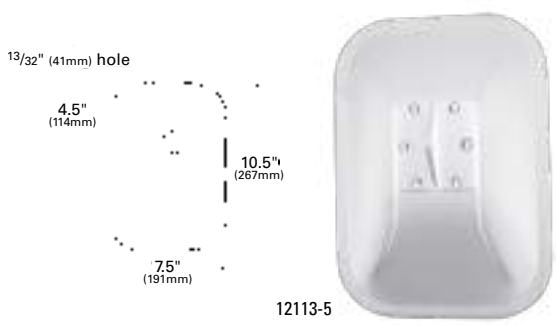

**BELOW-EYE-LEVEL MIRROR**

Offset mount • 7 1/2" x 10 1/2" mirror • Painted mirrors feature rugged powder-coated finish

**12111-5** White *RETAIL*  
**12113-5** Stainless Steel *RETAIL*

**Material:** Stainless Steel, Steel  
**Reflective:** 61 sq. in.  
**Finish:** Stainless, White  
**VMRS Code:** 002-010-026

### OUTER PROTECTIVE BUMPER MIRROR

Ball swivel • 7" x 10" rectangular mirror • Features rugged powder-coated finish

**12102** Black

**Material:** Steel  
**Reflective:** 52 sq. in.  
**Finish:** Black  
**VMRS Code:** 002-010-006

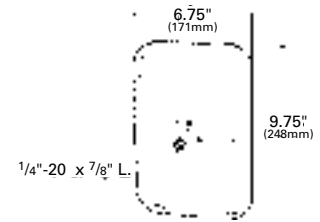

### SUPER TRIPOD-MOUNT MIRROR

Stainless steel tripod brackets • Offset mounting • Flips to total field of vision • Jumbo 7 1/2" x 10 1/2" stainless steel head

**28323-5** Stainless Steel **RETAIL**

**MIRROR HEAD:**

**12113-5** Stainless Steel **RETAIL**

**12111-5** White **RETAIL**

**Material:** Stainless Steel  
**Reflective:** 61 sq. in.  
**Finish:** Stainless, White  
**Accessory:** 90° Arm: 10623; Extension Arm: 10083  
**VMRS Code:** 002-010-006 - 28323-5  
002-010-026 - 12113-5, 12111-5



28323-5

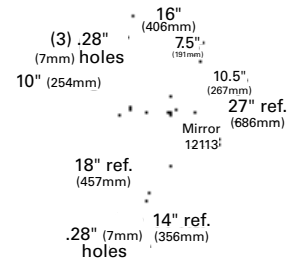

### 50" WIDE-VIEW MIRROR

OEM-styled mirror, fits right or left side • Two-screw ball swivel  
• Fits full-size pickup trucks and vans

**12193-5** Stainless Steel, Mirror Only **RETAIL**

**Material:** Stainless Steel  
**Reflective:** 50 sq. in.  
**Finish:** Stainless  
**VMRS Code:** 002-010-026

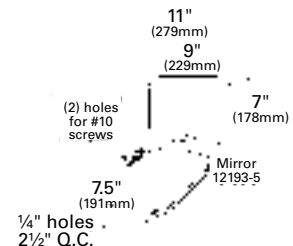

### FORD® TRUCK & VAN MIRROR

Swings back against body on impact • Memory detent locks back into original position

**28393-5** Chrome Mirror w/ Anodized Aluminum Bracket **RETAIL**  
**12263-5** Mirror Only **RETAIL**

**Material:** Steel, Aluminum  
**Reflective:** 38 sq. in.  
**Finish:** Aluminum  
**VMRS Code:** 002-010-006 - 28393-5  
022-010-026 - 12263-5

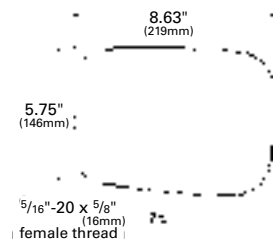



### MINI-TRUCK MIRROR

Fits door contours of mini import trucks • Easy-to-mount, plastic connectors  
• 5 1/2" x 7 1/2" mirror head

**28252-5** Black, Powder-Coated RETAIL

**Material:** Steel  
**Reflective:** 33 sq. in.  
**Finish:** Black  
**VMRS Code:** 002-010-006

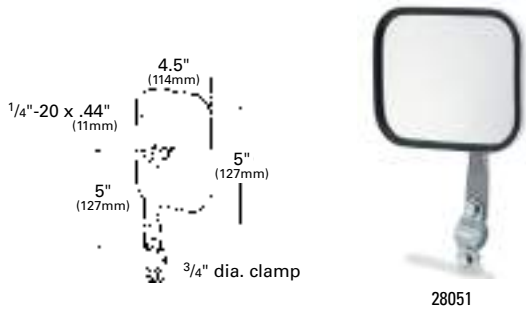

### RECTANGULAR STACK & SPOT MIRROR

Greater coverage of blind spots • Includes arm and clamp  
• Painted mirrors feature rugged powder-coated finish

**28051** White w/ Arm Assembly  
**12122** Black, Mirror Only

**Material:** Steel  
**Reflective:** 20 sq. in.  
**Finish:** White/ Black  
**VMRS Code:** 002-010-006 - 28051  
002-010-026 - 12122

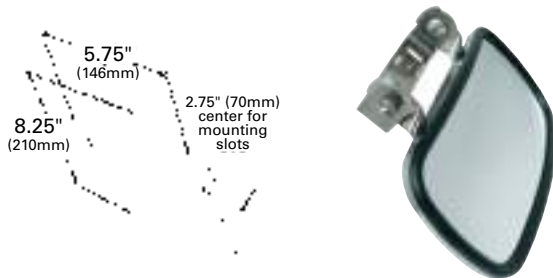

### RECTANGULAR OVER-THE-DOOR CONVEX MIRROR

9/16" x 5/16" mounting holes • For "look-down" mirror applications over passenger-side door

**28763** Over Door Convex

**Material:** Stainless Steel  
**Reflective:** 26 sq.in.  
**Finish:** Stainless  
**VMRS Code:** 002-010-026

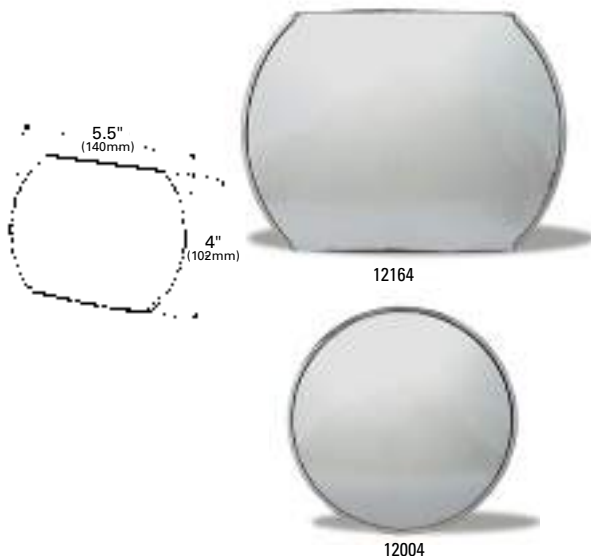

### STICK-ON CONVEX MIRROR

Extends driver's view • Bonds instantly • Single-strength silvered mirror  
• Aluminum mirror back

**ROUND:**

**12004** 3" RETAIL  
**12004-5** 3" RETAIL  
**12014** 3 3/4" RETAIL  
**12014-5** 3 3/4" RETAIL  
**12201-5** 2" RETAIL

**RECTANGULAR:**

**12164** 4" x 5 1/2"  
**12164-5** 4" x 5 1/2" RETAIL

**Material:** Aluminum  
**Regulations / Standards:** 96-hour corrosion test per ASTM B-117, will withstand 30 lb. pull test  
**Finish:** Aluminum  
**VMRS Code:** 002-010-008

### HOT SPOT MIRROR

Fits any flat surface • Weather-resistant high-strength adhesive

12312-5 Black **RETAIL**

**Material:** Polypropylene  
**Finish:** Black  
**VMRS Code:** 002-010-008

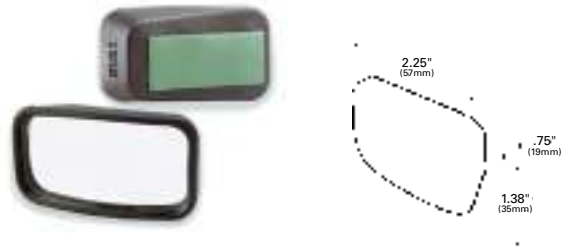

### 10" INSIDE REAR VIEW MIRROR

Non-glare adjustment lever • OEM styling • Includes mirror, mount, instructions, and adhesive

18302-5 Black **RETAIL**

**Material:** Polypropylene  
**Finish:** Black  
**VMRS Code:** 002-010-002



### WEST COAST MIRROR BRACKET ASSEMBLY

Complete kit includes mirror arms, mounting, hardware and instructions  
• Rigid mounting for West-Coast-style mirrors • Accommodates additional spot mirrors

22013 Stainless Steel

**Material:** Stainless Steel  
**VMRS Code:** 002-010-013

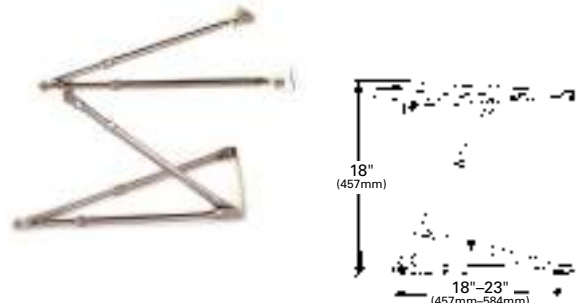

### C-LOOP BRACKET

Can be used in conjunction with most West-Coast-bracket assemblies  
• Allows for adjustable, "break-away" mounting of any 7"x16" or 6"x16" West Coast mirror • Accommodates additional stack-on spot mirrors

22233 Stainless Steel

**Material:** Stainless Steel  
**Finish:** Stainless  
**VMRS Code:** 002-010-013

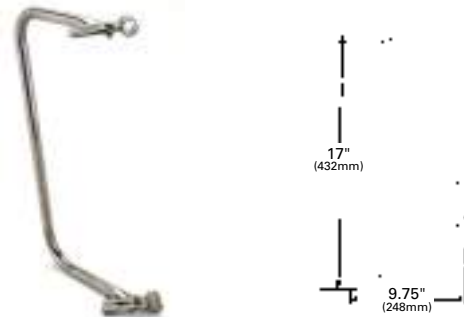

### WEST COAST HEATING ELEMENT REPLACEMENT

Defroster element fits West Coast style mirrors • Water-resistant  
• 40 watts • Fits 6" x 16" or 7" x 16" West Coast mirrors

29060 Element

**Material:** Adhesive Black Heated Board  
**Volts / Amps:** 12V / 3.1A  
**VMRS Code:** 002-010-006





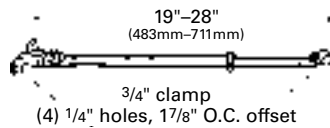

### HEAVY-DUTY ADJUSTABLE BRACE ARM

19"-28" • Zinc-coated steel

**10025** Adjustable Arm

**Material:** Steel

**Finish:** Zinc

**VMRS Code:** 002-010-013

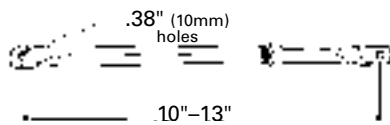

### ADJUSTABLE MIRROR ARM

Features rugged powder-coated finish

**10"-13" ARM:**

**10002** Black

**14"-22" ARM:**

**10012** Black

**10013** Chrome

**Material:** Steel

**Finish:** Black, Chrome

**VMRS Code:** 002-010-013

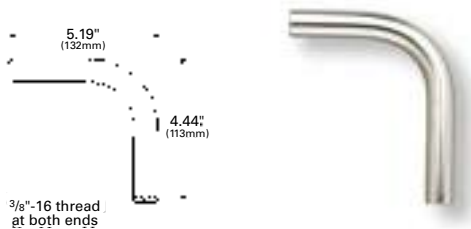

### 90° EXTENSION ARM

4 1/2" offset length

**10623** Aluminum

**Material:** Aluminum

**Finish:** Chrome

**VMRS Code:** 002-010-013



3/8" (10mm) holes

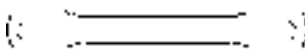

7.25"  
(184mm)

### 8" FLAT MIRROR ARM

Silver metallic powder-coated finish

**10045** Silver Finish

**Material:** Steel

**Finish:** Silver metallic

**VMRS Code:** 002-010-013

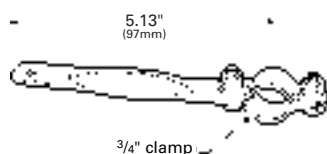

### EXTENSION ARM & CLAMP ASSEMBLY FOR STACK MIRRORS

**10073** Extension Arm

**Material:** Stainless Steel

**Finish:** Stainless

**VMRS Code:** 002-010-013

### UNIVERSAL MOUNTING KIT

Complete kit includes extension arm, clamp mounting, and hardware  
 • Perfect for adding on spot mirrors • Suited for 5" and 6" spot mirrors

10173 "L" Bracket

Material: Stainless Steel, Steel  
 VMRS Code: 002-010-013



### STAINLESS STEEL "L" BRACKET

Allows mounting of convex mirror on West Coast mirror bracket

11133 Stainless Steel

Material: Stainless Steel  
 VMRS Code: 002-010-013



### THROUGH-HOLE STYLE "L" BRACKET

Rugged construction • Perfect accessory for adding on spot mirrors  
 • For 3/4" mirror arm tubing

11303 "L" Bracket

Material: Stainless Steel  
 VMRS Code: 002-010-013



### TUBE CLAMP

Kit includes clamp and hardware • Perfect accessory for adding spot mirrors  
 • Rugged, bright stainless steel bracket construction

11293 3/4" Clamp, 3/8" Holes

Material: Stainless Steel, Steel  
 VMRS Code: 002-010-013



# 12

## TRAILER WIRING & COMMUNICATIONS SYSTEMS

*SYSTÈMES DE COMMUNICATION ET  
FILAGE DE REMORQUES*

*SISTEMAS DE ARNESES PARA  
REMOLQUE / CAJA DE CONEXIÓN*

## GROTE GUARDIAN® SMART SYSTEM

- **REAL-TIME ALERTS**

Get real-time alerts about your trailer lighting system sent straight to your smartphone or telematics system. Grote Guardian® samples at a rate of up to 100 times per second, measuring both voltage and current to determine when an event has occurred and let you know immediately.

- **OPTION FOR A GATEWAY DATA NOTIFICATION**

Set up a geofence, so any time a trailer enters the lot, it uploads data to a cloud-based server and generates a notification to the maintenance manager of any failures.

- **THE SYSTEM IS HIGHLY VERSATILE**

Simply integrating with the trailer via one of three Grote® nosebox options working with both LED and incandescent lights for all trailer types.

- **MAXIMIZE SECURITY AND UPTIME**

- **MINIMIZE MAINTENANCE COST AND CSA EXPOSURE**



Visit [Grote.com/Guardian](http://Grote.com/Guardian) to learn more and watch Grote Guardian® in action.



G7 Version



Geofence Gateway

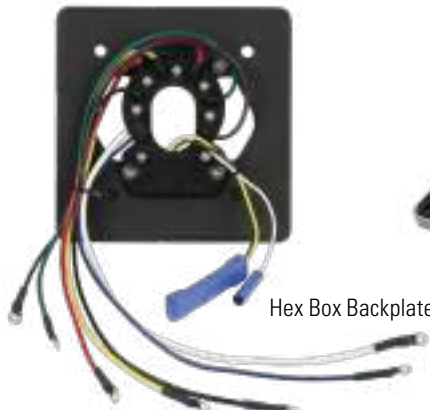

Hex Box Backplate



Ultra Nose Box Gen 3

VMRS Code: 036-009-000

Ultra-Blue-Seal®  
**UBS**

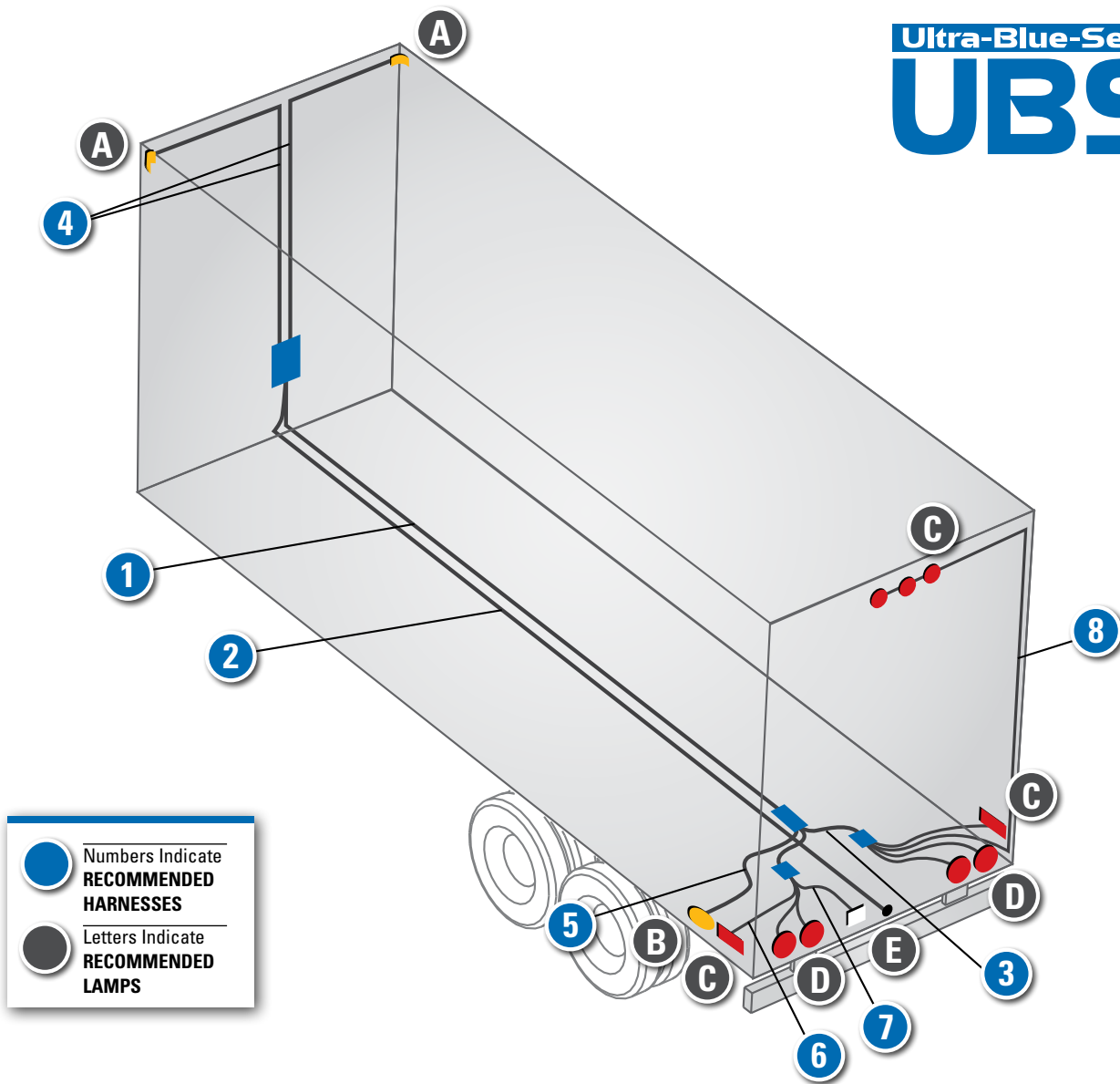

## RECOMMENDED LAMPS

### A FRONT MARKERS

|  |         |
|--|---------|
| SuperNova® 3" Thin-Line LED Clearance/Marker Lamp          | Page 47 |
| SuperNova® Sealed Turtleback® II LED Clearance/Marker Lamp | Page 55 |
| MicroNova® DOT LED Clearance/Marker Lamp                   | Page 35 |
| MicroNova® LED Clearance/Marker Lamp                       | Page 36 |

### B ABS

|  |         |
|--|---------|
| MicroNova® DOT LED Clearance/Marker Lamp | Page 35 |
| MicroNova® LED Clearance/Marker Lamp     | Page 36 |

### C REAR SIDE, CLEARANCE MARKERS & REAR I.D.

|  |         |
|--|---------|
| SuperNova® 3" Thin-Line LED Clearance/Marker Lamp          | Page 47 |
| SuperNova® Sealed Turtleback® II LED Clearance/Marker Lamp | Page 55 |
| MicroNova® DOT LED Clearance/Marker Lamp                   | Page 35 |
| MicroNova® LED Clearance/Marker Lamp                       | Page 36 |

### D STOP/TAIL/TURN

|   |         |
|---|---------|
| SuperNova® 4" LED Stop/ Tail/ Turn Lamp | Page 75 |
| SuperNova® 4" NexGen LED Stop/Tail/Turn | Page 77 |

### E LICENSE

|  |          |
|--|----------|
| MicroNova® Multi-Volt LED License Lamp     | Page 119 |
| MicroNova® Multi-Volt DOT LED License Lamp | Page 119 |



## 28' VAN TRAILER ULTRA-BLUE-SEAL® HARNESS SYSTEM

### 1 MAIN HARNESS

| Part #     | Front Connection  | ABS Drop | Wire Gauge      | Length | VMRS Code   |
|------------|-------------------|----------|-----------------|--------|-------------|
| 01-6670-L5 | #10 Ring Terminal | 60"      | 1-8, 2-10, 4-12 | 420"   | 034-004-023 |

### 2 PINTLE MAIN

| Part #     | Forward Connection | Rear Connection   | Wire Gauge      | Length | VMRS Code   |
|------------|--------------------|-------------------|-----------------|--------|-------------|
| 01-6660-K3 | #10 Ring Terminal  | Push-On           | 1-8, 2-10, 4-12 | 420"   | 034-004-023 |
| 66601      | #10 Ring Terminal  | #10 Ring Terminal | 1-8, 2-10, 4-12 | 420"   | 034-004-023 |

### 3 REAR SILL

| Part #     | Lamp Plug         | Curb Side | Road Side | ABS Drop | VMRS Code   |
|------------|-------------------|-----------|-----------|----------|-------------|
| 01-6758-86 | Straight Male Pin | 60"       | 50"       | 53"      | 034-004-023 |
| 01-6758-87 | Straight Male Pin | 89"       | 16"       | 18"      | 034-004-023 |

### 4 FRONT MARKER HARNESS

| Part#      | Lamp Connection       | Power Connection    | Length | Side | VMRS Code   |
|------------|-----------------------|---------------------|--------|------|-------------|
| 66222      | .180 Slim-Line Female | .180 Slim-Line Male | 96"    | Road | 034-004-023 |
| 05-2018-93 | .180 Slim-Line Female | .180 Slim-Line Male | 144"   | Curb | 034-004-023 |
| 01-6620-C8 | .180 Slim-Line Female | #10 ring terminal   | 96"    | Road | 034-004-023 |
| 01-6620-C9 | .180 Slim-Line Female | #10 Ring Terminal   | 144"   | Curb | 034-004-023 |

### 5 ABS FAULT LAMP HARNESS

| Part# | Lamp Connection       | Power Connection    | Length | VMRS Code   |
|-------|-----------------------|---------------------|--------|-------------|
| 66203 | .180 Slim-Line Female | .180 Slim Line Male | 72"    | 034-004-023 |

### 6 REAR MARKER HARNESS

| Part#      | Lamp Connection       | Power Connection    | Length | VMRS Code   |
|------------|-----------------------|---------------------|--------|-------------|
| 01-6707-A9 | Turtleback® II        | .180 Slim-Line Male | 24"    | 034-004-042 |
| 01-6693-74 | Thinline LED          | .180 Slim-Line Male | 24"    | 034-004-042 |
| 05-2018-47 | .180 Slim-Line Female | .180 Slim-Line Male | 24"    | 034-004-023 |

### 7 LICENSE LAMP HARNESS

| Part# | Lamp Connection       | Power Connection    | Length | VMRS Code   |
|-------|-----------------------|---------------------|--------|-------------|
| 66221 | .180 Slim-Line Female | .180 Slim-Line Male | 60"    | 034-004-023 |

### 8 REAR I.D. HARNESS

| Part#      | Lamp Connection       | Power Connection    | Length                       | VMRS Code   |
|------------|-----------------------|---------------------|------------------------------|-------------|
| 01-6707-C3 | Turtleback® II        | .180 Slim-Line Male | 120" w/12" On Center Spacing | 034-004-023 |
| 66402      | Thinline LED          | .180 Slim-Line Male | 120" w/12" On Center Spacing | 034-004-023 |
| 01-6621-A9 | .180 Slim-Line Female | .180 Slim-Line Male | 120" w/12" On Center Spacing | 034-004-023 |

Lamp connection descriptions and information begins on page 255

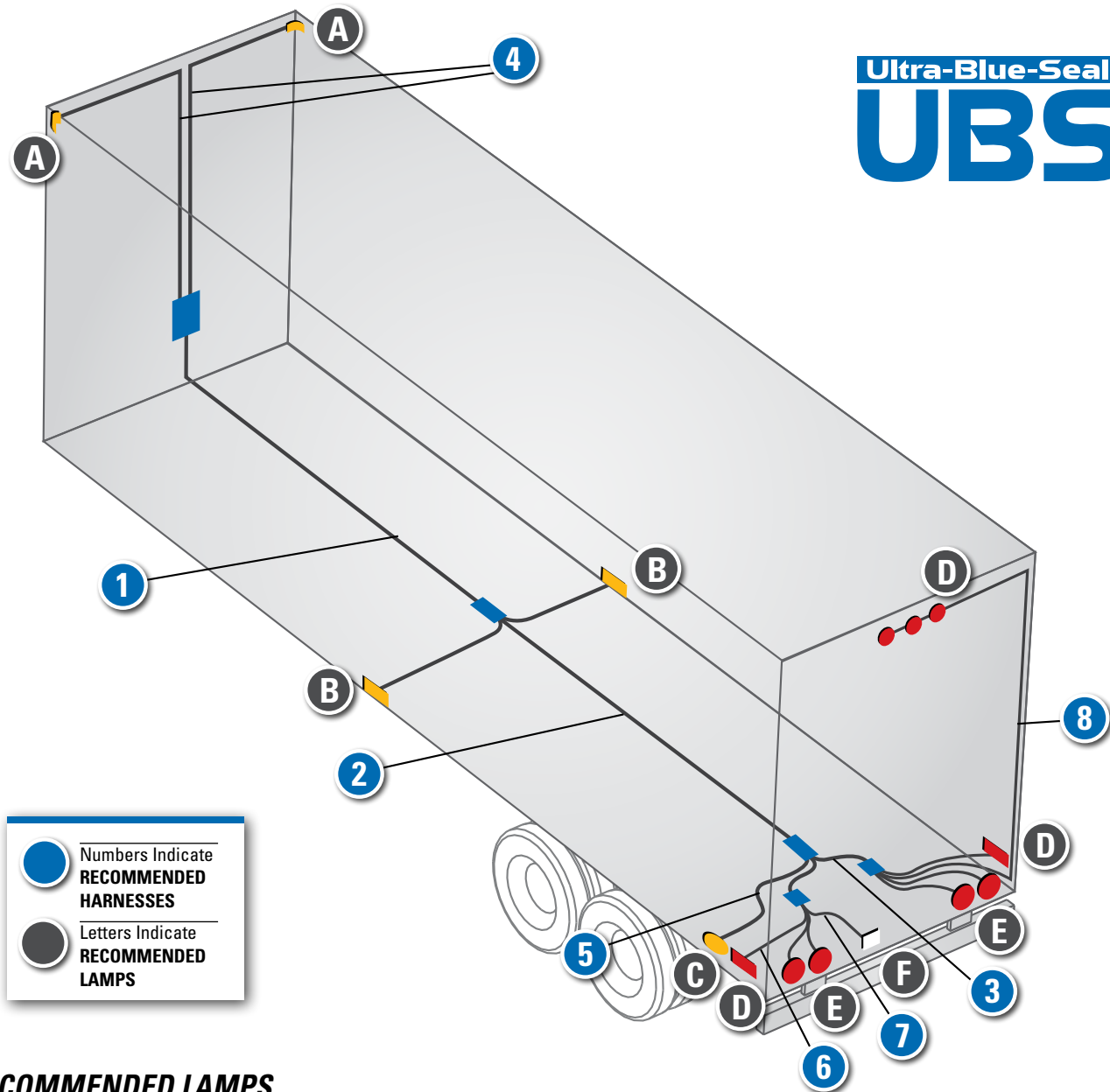

## RECOMMENDED LAMPS

### A FRONT MARKERS

|  |         |
|--|---------|
| SuperNova® 3" Thin-Line LED Clearance/Marker Lamp          | Page 47 |
| SuperNova® Sealed Turtleback® II LED Clearance/Marker Lamp | Page 55 |
| MicroNova® DOT LED Clearance/Marker Lamp                   | Page 35 |
| MicroNova® LED Clearance/Marker Lamp                       | Page 36 |

### B MID-TURN

|   |         |
|---|---------|
| SuperNova® Oval LED Side Turn/Marker Lamp | Page 86 |
|---|---------|

### C ABS

|  |         |
|--|---------|
| MicroNova® DOT LED Clearance/Marker Lamp | Page 35 |
| MicroNova® LED Clearance/Marker Lamp     | Page 36 |

### D REAR SIDE, CLEARANCE MARKERS & REAR I.D.

|  |         |
|--|---------|
| SuperNova® 3" Thin-Line LED Clearance/Marker Lamp          | Page 47 |
| SuperNova® Sealed Turtleback® II LED Clearance/Marker Lamp | Page 55 |
| MicroNova® DOT LED Clearance/Marker Lamp                   | Page 35 |
| MicroNova® LED Clearance/Marker Lamp                       | Page 36 |

### E STOP/TAIL/TURN

|   |         |
|---|---------|
| SuperNova® 4" LED Stop/ Tail/ Turn Lamp | Page 75 |
| SuperNova® 4" NexGen LED Stop/Tail/Turn | Page 77 |

### F LICENSE

|  |          |
|--|----------|
| MicroNova® Multi-Volt LED License Lamp     | Page 119 |
| MicroNova® Multi-Volt DOT LED License Lamp | Page 119 |

**53' VAN TRAILER ULTRA-BLUE-SEAL® HARNESS SYSTEM****1 FORWARD MAIN**

| Part #     | Front Connection  | Curb Side | Road Side | Wire Gauge | Length | VMRS Code   |
|------------|-------------------|-----------|-----------|------------|--------|-------------|
| 01-6661-A2 | Push-On           | 56"       | 56"       | 1-10, 6-12 | 375"   | 034-004-023 |
| 01-6660-M6 | Push-On           | 108"      | 15"       | 1-10, 6-12 | 375"   | 034-004-023 |
| 01-6605-W3 | #10 Ring Terminal | 108"      | 15"       | 1-10, 6-12 | 375"   | 034-004-023 |
| 01-6606-X3 | #10 Ring Terminal | 56"       | 56"       | 1-10, 6-12 | 375"   | 034-004-023 |

**2 INTERMEDIATE MAIN**

| Part #     | Length | ABS Drop | Wire Gauge | VMRS Code   |
|------------|--------|----------|------------|-------------|
| 01-6605-W7 | 342"   | 132"     | 1-10, 6-12 | 034-004-023 |
| 01-6605-X4 | 288"   | 180"     | 1-10, 6-12 | 034-004-023 |

**3 REAR SILL**

| Part #     | Lamp Plug         | Curb Side | Road Side | ABS Drop | Wire Gauge | VMRS Code   |
|------------|-------------------|-----------|-----------|----------|------------|-------------|
| 01-6758-86 | Straight Male Pin | 60"       | 50"       | 53"      | 1-12, 4-14 | 034-004-023 |
| 01-6758-87 | Straight Male Pin | 89"       | 16"       | 18"      | 1-12, 4-14 | 034-004-023 |

**4 FRONT MARKER HARNESS**

| Part#      | Lamp Connection       | Power Connection    | Length | Side | VMRS Code   |
|------------|-----------------------|---------------------|--------|------|-------------|
| 66222      | .180 Slim-Line Female | .180 Slim-Line Male | 96"    | Road | 034-004-023 |
| 05-2018-93 | .180 Slim-Line Female | .180 Slim-Line Male | 144"   | Curb | 034-004-023 |
| 01-6620-C8 | .180 Slim-Line Female | #10 ring terminal   | 96"    | Road | 034-004-023 |
| 01-6620-C9 | .180 Slim-Line Female | #10 Ring Terminal   | 144"   | Curb | 034-004-023 |

**5 ABS FAULT LAMP HARNESS**

| Part# | Lamp Connection       | Power Connection    | Length | VMRS Code   |
|-------|-----------------------|---------------------|--------|-------------|
| 66203 | .180 Slim-Line Female | .180 Slim-Line Male | 72"    | 034-004-023 |

**6 REAR MARKER HARNESS**

| Part#      | Lamp Connection       | Power Connection    | Length | VMRS Code   |
|------------|-----------------------|---------------------|--------|-------------|
| 01-6707-A9 | Turtleback® II        | .180 Slim-Line Male | 24"    | 034-004-042 |
| 01-6693-74 | Thinline LED          | .180 Slim-Line Male | 24"    | 034-004-042 |
| 05-2018-47 | .180 Slim-Line Female | .180 Slim-Line Male | 24"    | 034-004-023 |

**7 LICENSE LAMP HARNESS**

| Part# | Lamp Connection       | Power Connection    | Length | VMRS Code   |
|-------|-----------------------|---------------------|--------|-------------|
| 66221 | .180 Slim-Line Female | .180 Slim-Line Male | 60"    | 034-004-023 |

**8 REAR I.D. HARNESS**

| Part#      | Lamp Connection       | Power Connection    | Length                       | VMRS Code   |
|------------|-----------------------|---------------------|------------------------------|-------------|
| 01-6707-C3 | Turtleback® II        | .180 Slim-Line Male | 120" w/12" On Center Spacing | 034-004-023 |
| 66402      | Thinline LED          | .180 Slim-Line Male | 120" w/12" On Center Spacing | 034-004-023 |
| 01-6621-A9 | .180 Slim-Line Female | .180 Slim-Line Male | 120" w/12" On Center Spacing | 034-004-023 |

Lamp connection descriptions and information begins on page 255

Ultra-Blue-Seal®  
**UBS**

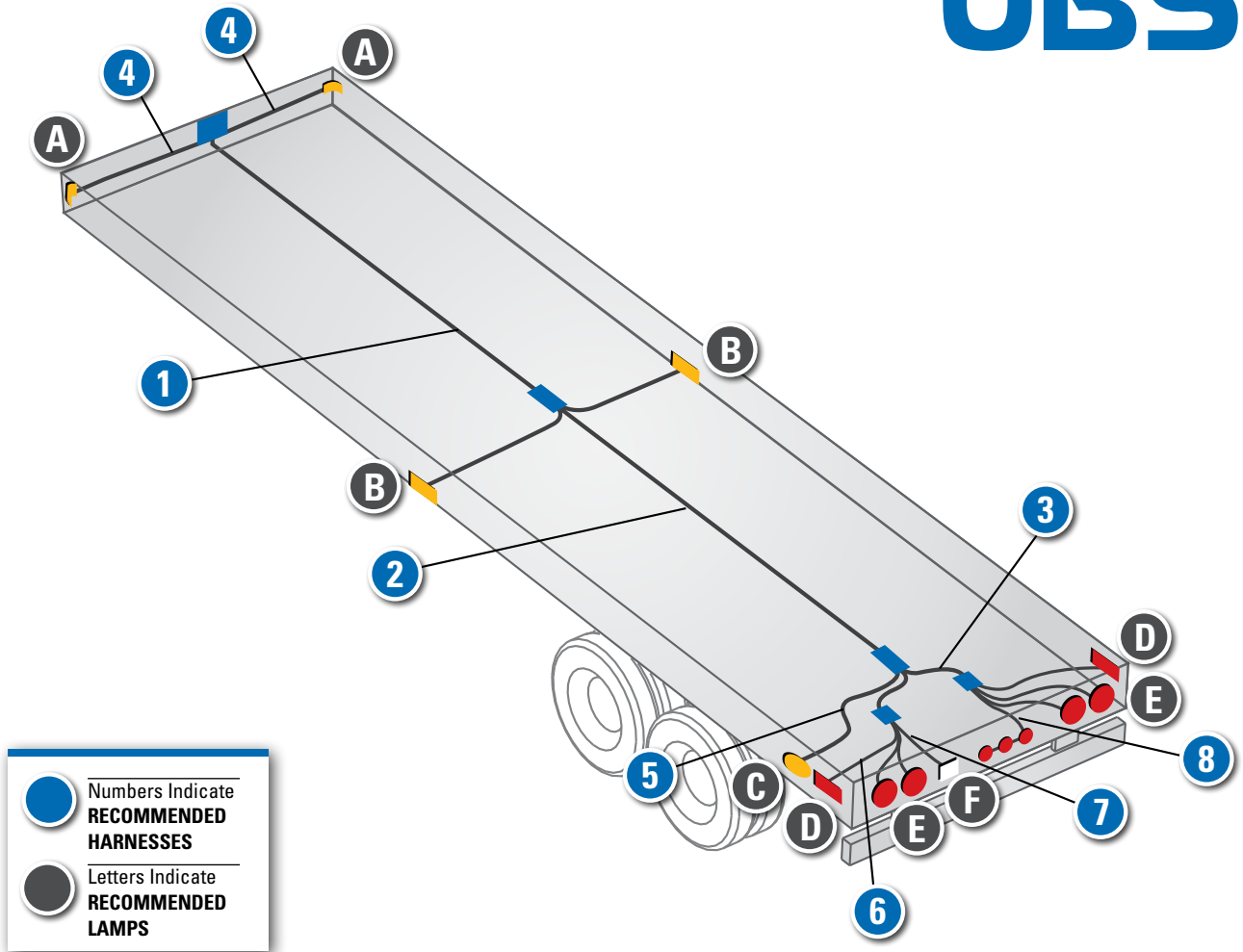

## RECOMMENDED LAMPS

### A FRONT MARKERS

|  |         |
|--|---------|
| SuperNova® 3" Thin-Line LED Clearance/Marker Lamp          | Page 47 |
| SuperNova® Sealed Turtleback® II LED Clearance/Marker Lamp | Page 55 |
| MicroNova® DOT LED Clearance/Marker Lamp                   | Page 35 |
| MicroNova® LED Clearance/Marker Lamp                       | Page 36 |

### B MID-TURN

|   |         |
|---|---------|
| SuperNova® Oval LED Side Turn/Marker Lamp | Page 86 |
|---|---------|

### C ABS

|  |         |
|--|---------|
| MicroNova® DOT LED Clearance/Marker Lamp | Page 35 |
| MicroNova® LED Clearance/Marker Lamp     | Page 36 |

### D REAR SIDE, CLEARANCE MARKERS & REAR I.D.

|  |         |
|--|---------|
| SuperNova® 3" Thin-Line LED Clearance/Marker Lamp          | Page 47 |
| SuperNova® Sealed Turtleback® II LED Clearance/Marker Lamp | Page 55 |
| MicroNova® DOT LED Clearance/Marker Lamp                   | Page 35 |
| MicroNova® LED Clearance/Marker Lamp                       | Page 36 |

### E STOP/TAIL/TURN

|   |         |
|---|---------|
| SuperNova® 4" LED Stop/ Tail/ Turn Lamp | Page 75 |
| SuperNova® 4" NexGen LED Stop/Tail/Turn | Page 77 |

### F LICENSE

|  |          |
|--|----------|
| MicroNova® Multi-Volt LED License Lamp     | Page 119 |
| MicroNova® Multi-Volt DOT LED License Lamp | Page 119 |

## 53' FLATBED ULTRA-BLUE-SEAL® HARNESS SYSTEM

### 1 MAIN HARNESS

| Part #     | Front Connection  | Curb Side | Road Side | Wire Gauge | Length | VMRS Code   |
|------------|-------------------|-----------|-----------|------------|--------|-------------|
| 01-6661-A2 | Push-On           | 56"       | 56"       | 1-10, 6-12 | 375"   | 034-004-023 |
| 01-6660-M6 | Push-On           | 108"      | 15"       | 1-10, 6-12 | 375"   | 034-004-023 |
| 01-6605-W3 | #10 Ring Terminal | 108"      | 15"       | 1-10, 6-12 | 375"   | 034-004-023 |
| 01-6606-X3 | #10 Ring Terminal | 56"       | 56"       | 1-10, 6-12 | 375"   | 034-004-023 |

### 2 INTERMEDIATE MAIN

| Part #     | Length | ABS Drop | Wire Gauge | VMRS Code   |
|------------|--------|----------|------------|-------------|
| 01-6605-W7 | 342"   | 132"     | 1-10, 6-12 | 034-004-023 |
| 01-6605-X4 | 288"   | 180"     | 1-10, 6-12 | 034-004-023 |

### 3 REAR SILL

| Part #     | Lamp Plug         | Curb Side | Road Side | ABS Drop | VMRS Code   |
|------------|-------------------|-----------|-----------|----------|-------------|
| 01-6758-86 | Straight Male Pin | 60"       | 50"       | 53"      | 034-004-023 |
| 01-6758-87 | Straight Male Pin | 89"       | 16"       | 18"      | 034-004-023 |

### 4 FRONT MARKER HARNESS

| Part#      | Lamp Connection                | Power Connection    | Length | Side | VMRS Code   |
|------------|--------------------------------|---------------------|--------|------|-------------|
| 01-6620-E9 | .180 Slim-Line Female          | .180 Slim-Line Male | 48"    | Road | 034-004-023 |
| 66222      | .180 Slim-Line Female          | .180 Slim-Line Male | 96"    | Curb | 034-004-023 |
| 01-6620-F1 | .180 Slim-Line Female          | .180 Slim-Line Male | 48"    | Road | 034-004-023 |
| 01-6620-C8 | .180 Slim-Line Female          | #10 Ring terminal   | 96"    | Road | 034-004-023 |
| 01-6620-F2 | .180 Slim-Line Female Flo-Thru | .180 Slim-Line Male | 48"    | Road | 034-004-023 |
| 01-6621-C1 | .180 Slim-Line Female Flo-Thru | .180 Slim-Line Male | 96"    | Curb | 034-004-023 |
| 01-6620-F3 | .180 Slim-Line Female Flo-Thru | #10 Ring Terminal   | 48"    | Road | 034-004-023 |
| 01-6621-C3 | .180 Slim-Line Female Flo-Thru | #10 Ring Terminal   | 96"    | Curb | 034-004-023 |

### 5 ABS FAULT LAMP HARNESS

| Part# | Lamp Connection       | Power Connection    | Length | VMRS Code   |
|-------|-----------------------|---------------------|--------|-------------|
| 66203 | .180 Slim-Line Female | .180 Slim-Line Male | 72"    | 034-004-023 |

### 6 REAR MARKER HARNESS

| Part#      | Lamp Connection       | Power Connection    | Length | VMRS Code   |
|------------|-----------------------|---------------------|--------|-------------|
| 01-6707-A9 | Turtleback® II        | .180 Slim-Line Male | 24"    | 034-004-042 |
| 01-6693-74 | Thinline LED          | .180 Slim-Line Male | 24"    | 034-004-042 |
| 05-2018-47 | .180 Slim-Line Female | .180 Slim-Line Male | 24"    | 034-004-023 |

### 7 LICENSE LAMP HARNESS

| Part# | Lamp Connection       | Power Connection    | Length | VMRS Code   |
|-------|-----------------------|---------------------|--------|-------------|
| 66221 | .180 Slim-Line Female | .180 Slim-Line Male | 60"    | 034-004-023 |

### 8 REAR I.D. HARNESS

| Part#      | Lamp Connection       | Power Connection    | Length                      | VMRS Code   |
|------------|-----------------------|---------------------|-----------------------------|-------------|
| 01-6707-C2 | Turtleback® II        | .180 Slim-Line Male | 36" w/12" On Center Spacing | 034-004-023 |
| 66403      | Thinline LED          | .180 Slim-Line Male | 36" w/12" On Center Spacing | 034-004-023 |
| 01-6621-C7 | .180 Slim-Line Female | .180 Slim-Line Male | 36" w/9" On Center Spacing  | 034-004-023 |

Lamp connection descriptions and information begins on page 255



## GROTE® ULTRALINK POWER CORDS: SUPERIOR POWER DELIVERY

Grote's UltraLink Cords provide maximum reliability in the harshest environments. UltraLink Power Cords feature a crush-resistant plug and deliver improved performance, longer wear, and superior conductivity at a competitive price.

### PLUG DESIGN

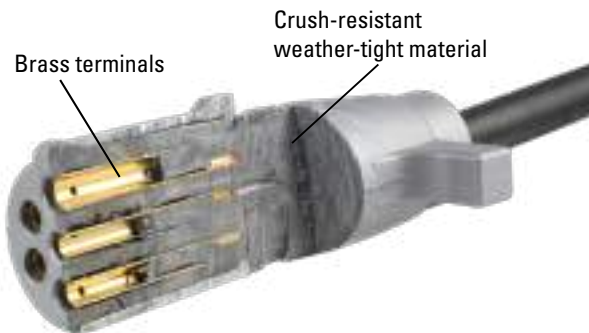

### CABLE-TO-PLUG SEAL

Cable jacket is molded into the plug, sealing it from the elements and eliminating the need for an additional strain relief.



### BRASS TERMINALS

Two rugged spring clips on each terminal prevent excessive opening of the terminals and greatly reduce intermittent connections.

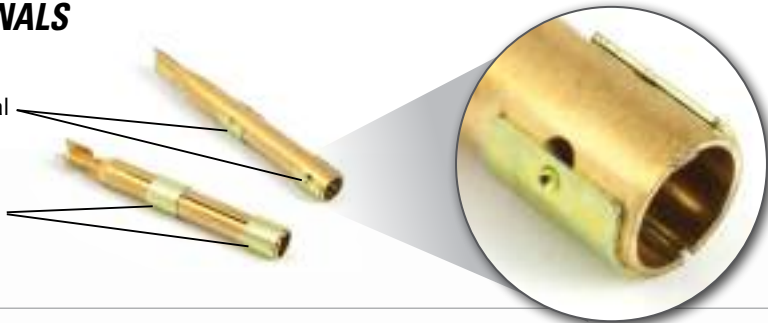

## ULTRALINK ABS POWER CORDS

UltraLink power cords exceed minimum legal lamp power delivery requirements for single or double trailer configurations

- Zinc die-cast plugs are filled with elastomeric material that resists crushing & acts as potting to seal solid brass terminals from moisture
- Provides excellent recoil memory, chemical, and abrasion resistance
- Adhesive bonds cable to plug, eliminating need for supporting spring and preventing moisture from entering the back of the plug
- Solid brass terminals are corrosion resistant, and provide superior current capacity with minimal voltage drop
- Advanced polymer jacketing material provides complete sealing and abrasion protection between -55°F and 190°F (premium versions)

### COILED:

|              |  |
|--------------|--|
| <b>87100</b> | 1/8, 2/10, 4/12, 12', w/12" Leads, Coiled                  |
| <b>87103</b> | 1/8, 2/10, 4/12, 12', w/12" Leads, Coiled, Premium         |
| <b>87101</b> | 1/8, 2/10, 4/12, 15', w/12" Leads, Coiled                  |
| <b>87104</b> | 1/8, 2/10, 4/12, 15', w/12" Leads, Coiled, Premium         |
| <b>87105</b> | 1/8, 2/10, 4/12, 20', w/36" and 12" Leads, Coiled, Premium |
| <b>87170</b> | 1/8, 2/10, 4/12, 15', w/48" and 12" Leads, Coiled          |

### STRAIGHT:

|              |                                |
|--------------|--------------------------------|
| <b>87190</b> | 1/8, 2/10, 4/12, 7', Straight  |
| <b>87191</b> | 1/8, 2/10, 4/12, 8', Straight  |
| <b>87192</b> | 1/8, 2/10, 4/12, 9', Straight  |
| <b>87193</b> | 1/8, 2/10, 4/12, 10', Straight |
| <b>87171</b> | 1/8, 2/10, 4/12, 12', Straight |
| <b>87172</b> | 1/8, 2/10, 4/12, 15', Straight |
| <b>87173</b> | 1/8, 2/10, 4/12, 20', Straight |

**Material:** Polyurethane (Premium), EVA (Standard)

**Regulations / Standards:** SAE J560b™, J2222™, J2394™

**Finish:** Green

**VMRS Code:** 034-003-037



## ULTRALINK POWER CORDS (NON-ABS)

UltraLink power cords exceed minimum legal lamp power delivery requirements for single or double trailer configurations

- Zinc die-cast plugs are filled with elastomeric material that resists crushing & acts as potting to seal solid brass terminals from moisture
- Adhesive bonds cable to plug, eliminating need for supporting spring and preventing moisture from entering the back of the plug
- Solid brass terminals are corrosion resistant, and provide superior current capacity with minimal voltage drop

### COILED:

|              |  |
|--------------|--|
| <b>87110</b> | 1/12, 6/14, 12', w/12" Leads             |
| <b>87020</b> | 1/10, 6/12, 12', w/12" Leads, HD         |
| <b>87111</b> | 1/12, 6/14, 15', w/12" Leads             |
| <b>87023</b> | 1/10, 6/12, 15', w/12" Leads, HD         |
| <b>87181</b> | 1/10, 6/12, 15', w/48" and 12" Leads, HD |
| <b>87112</b> | 1/12, 6/14, 15', w/72" and 12" Leads     |
| <b>87180</b> | 1/10, 6/12, 15', w/72" and 12" Leads, HD |

### STRAIGHT:

|              |                 |
|--------------|-----------------|
| <b>87182</b> | 1/10, 6/12, 15' |
|--------------|-----------------|

**Material:** EVA (Standard)

**Regulations / Standards:** SAE J560™, J2222™

**Finish:** Black

**VMRS Code:** 034-003-037



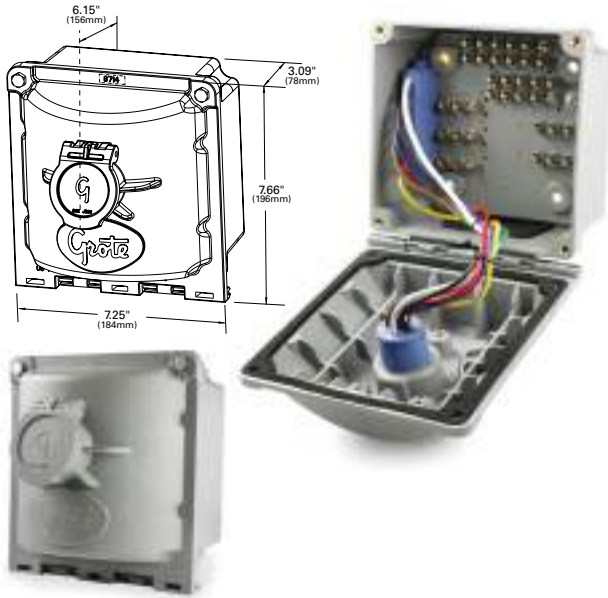

## ULTRA NOSE BOX

Replaceable 7-pin insert for easy maintenance • 39-pin connections eliminates overcrowding of wires • Hinged door keeps elements out, while providing easy access • Insert-molded pins helps prevent accidental disconnects

- 87141** Gray, Solid Pin  
**87151** Gray, Split Pin

**Material:** Nylon

**Regulations / Standards:** SAE J560™

**Finish:** Gray

**Accessory:** 7-pin insert: 97900 (solid pin), 97800 (split pin)

Replacement Door, Largo, Solid Pin: 97831

Rubber Grommet: 97810

Pigtail: 01-6623-P9

20A Circuit Breaker: 01-6624-W4

**VMRS Code:** 034-003-034

## ULTRA-PIN RECEPTACLE TWO-HOLE MOUNT

No-rust, die-cast zinc • Heavy bosses for extra rigidity • Barrel slanted to drain moisture • Mounting holes slotted for universal fit • Floating pins for easy alignment and solid mating • Two male terminals for grounding • Brass pins • 87270 includes 99510 retrofit kit • 99510 consists of 14 terminals and 9 boots

- 87250** Receptacle Only, Split Pin  
**87860** Receptacle Only, Solid Pin  
**87270** Receptacle w/ Terminal Kit, Split Pin

### RETROFIT KIT

- 99510** Plug-In Terminal Kit  
**99680** Door Replacement Kit

**Material:** Die-cast Zinc

**Regulations / Standards:** SAE J560™

**VMRS Code:** 034-003-034 - 87250, 57260, 87270, 99680  
 034-004-023 - 99510

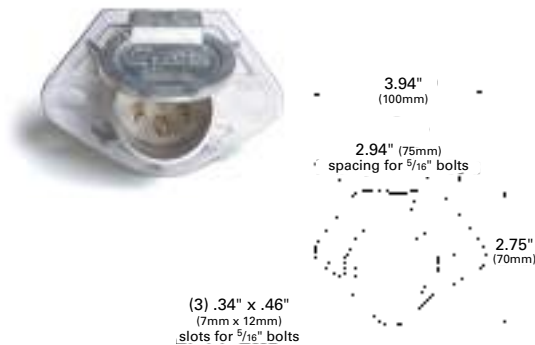

## ULTRA-PIN RECEPTACLE THREE-HOLE MOUNT

No-rust, die-cast zinc • Heavy bosses for extra rigidity • Barrel slanted to drain moisture • Mounting holes slotted for universal fit • Floating pins for easy alignment and solid mating • Two male terminals for grounding • Brass pins • 87240 includes 99510 retrofit kit • 99510 consists of 14 terminals and 9 boots

- 87240** Receptacle w/ Terminal Kit, Split Pin  
**87220** Receptacle Only, Split Pin

### RETROFIT KIT

- 99510** Plug-In Terminal Kit  
**99680** Door Replacement Kit

**Material:** Die-cast Zinc

**Regulations / Standards:** SAE J560™

**VMRS Code:** 034-003-034 - 87240, 87220, 99680  
 034-004-023 - 99510  
 034-004-075 - 99601



### ULTRA-PIN RECEPTACLE FOUR-HOLE MOUNT NOSE BOX

Extra-heavy bosses • Slanted barrel for drainage • Floating pins for easy alignment and solid mating connection • High-impact retainer plate  
 • Brass pins • Die-cast aluminum housing resists rust

- 87590** Solid Pin
- 87830** Split Pin

**Material:** Die-cast Aluminum  
**VMRS Code:** 034-003-034

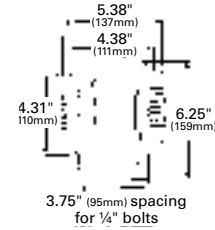

### RECEPTACLE MOUNTING BOX

Mounting for 87250, 87860, 87270, 87220, 87850, 87240

- 43684** Receptacle Box
- 99680** Door Replacement Kit - Used on 87250, 87860, 87270, 87240 and 87220. Kit contains die-cast zinc door, brass hinge pin and spring

**Material:** Cast Aluminum  
**VMRS Code:** 034-003-034

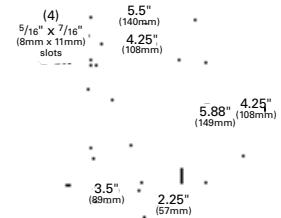

### RETROFIT PLUG-IN TERMINAL KIT

- 99510** Plug-In Terminal Kit - Plugs into 87220, 87850, 87250, 87860, 87590 and 87830 receptacles • Kit contains 9 boots and 14 terminals • 5 terminals for larger gauge wire
- 99680** Door Replacement Kit - Used on 87250, 87860, 87270, 87240 and 87220. Kit contains die-cast zinc door, brass hinge pin and spring

**VMRS Code:** 034-004-023 - 99510  
 034-003-034 - 99680  
 034-004-075 - 99601



99510



99680

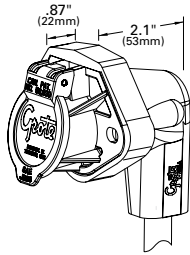

87212



87214

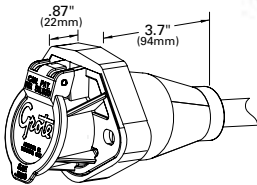

## ULTRA-SEAL G7

Ultra-Seal G7 is the standard for low-profile, water-resistant harness connection

- Spacer made of thicker and harder durometer PVC that resists deforming under mounting pressure
- Flush-mount design allows water to be directed away from the wire exit hole in the trailer
- Two alignment pins aid in installation, allowing for easier terminal connections
- Plug design seals the back of the receptacle
- Receptacle is recessed into the gasket for sealing
- Receptacle is non-rust, die-cast zinc with solid brass pins

### 87214 Straight Plug & Receptacle With 7-Way Female

**Length:** 24"/610mm

**Gauge:** 1/10, 6/12

### 87215 Straight Plug & Receptacle With 7-Way Male

**Length:** 24"/610mm

**Gauge:** 1/8, 2/10, 4/12

### 87210 90° Plug & Receptacle With 7-Way Female And Drops For Marker Lamps (Grounded And Black)

**Length:** 24"/610mm

**Gauge:** 1/10, 6/12

### 87211 90° Plug & Receptacle With 7 Standard Females And Drops For Marker Lamps (Grounded And Black)

**Length:** 24"/610mm

**Gauge:** 1/10, 6/12

### 87212 90° Plug & Receptacle Blunt Cut With Drops For Marker Lamps (Grounded And Black)

**Length:** 24"/610mm

**Gauge:** 1/10, 6/12

**VMRS Code:** 034-002-036

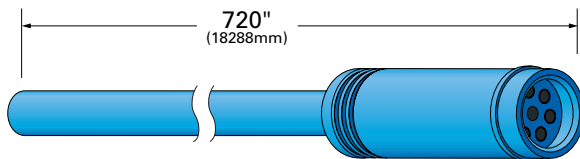

## ULTRA-BLUE-SEAL® MAIN HARNESS

Extends from front of nose box or receptacle and provides sealed plug-in connection to real sill harness

**1-8 GAUGE, 2-10 GAUGE, 4-12 GAUGE:**

**66071** 60' Long

**VMRS Code:** 034-004-023

## ULTRA-BLUE-SEAL® MAIN HARNESS ABS ADAPTER

Junction between main harness and real sill harness

- Provides sealed plug-in connection and a drop-out extension for ABS
- Ground return
- ABS fault lamp connection

**ABS FAULT LIGHT:**

**66705** 12" Long

**VMRS Code:** 034-004-023

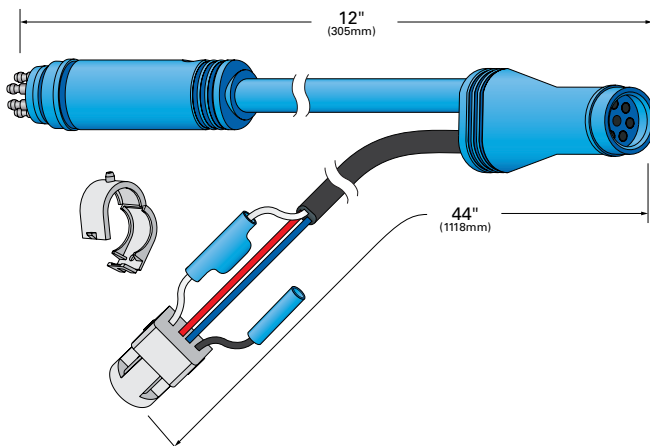



**ULTRA-BLUE-SEAL® 7-CONDUCTOR RECEPTACLE MAIN HARNESS**

Ultra-Pin receptacle is overmolded • Two-hole mount, solid pin (87860)

- 01-6608-E9** Main Harness with Drop (female 7-way)
- 01-6608-F9** Main Harness (male 7-way)

**VMRS Code:** 034-004-023

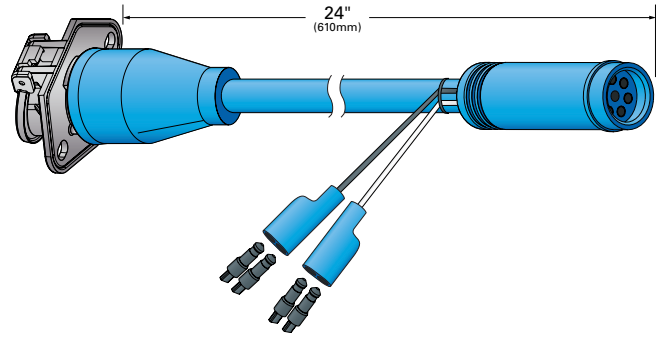

**ULTRA-BLUE-SEAL® HARNESS REAR SILL OPTION**

All connections weather-sealed by simple, foolproof UBS plugs • Entire harness double-jacketed for extra resistance to road-splash and abrasion  
 • Redundant frame ground with ring terminal

**FOR FEMALE PIN LAMPS:**

- 67570** 56" Long, Ground Return, Blue Drop
- 67571** 56" Long, Ground Return, ABS Connection

**FOR MALE PIN LAMPS:**

- 67581** 56" Long, Ground Return, Blue Drop
- 67580** 56" Long, Ground Return, ABS Connection

**VMRS Code:** 034-004-023

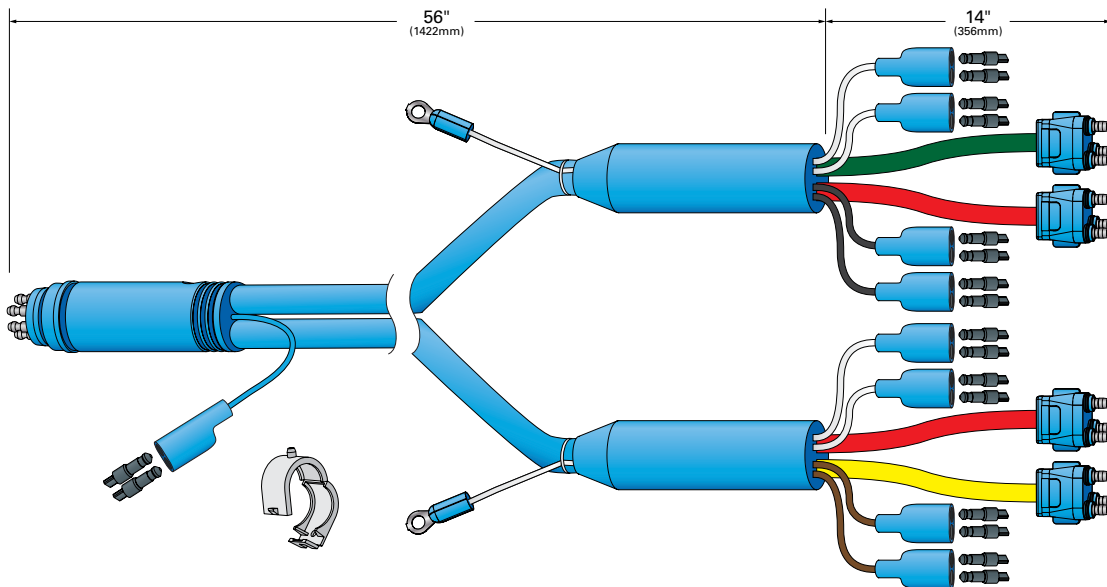

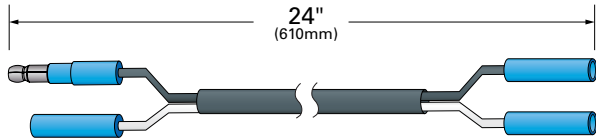

### ULTRA-BLUE-SEAL® GROUND RETURN TRACKING HARNESS

For use with elbow-style rear sill

STANDARD MALE/STANDARD FEMALE TO 2 SLIM-LINE UNDERLAMP FEMALES:

66223 2' Long  
66224 3' Long

VMRS Code: 034-004-023

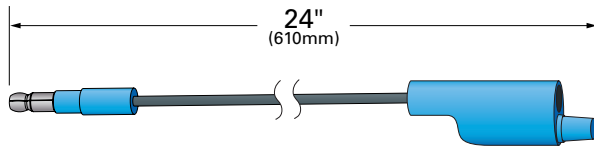

### CUT-TO-FIT® WIRE HARNESS SYSTEMS

This Cut-To-Fit® Wire Harness System adapts to the standard Grote® Ultra-Blue-Seal® rear sill and main harness • Part number 67271 (24" standard male to Cut-To-Fit® Slim-Line jumper) plugs into rear sill, making a corrosion-proof connection • Cut-To-Fit® jumpers can then be plugged directly into the double Slim-Line plugs • Cut-To-Fit® wire harness mates with the Grote® 7-pin receptacle (nose box) with the use of either the 67260 adapter or the 67250 • All wires 12-gauge

67271 Rear Sill Adapter  
67260 Nose Box Adapter  
67250 Double Nose Box Adapter

VMRS Code: 034-004-023

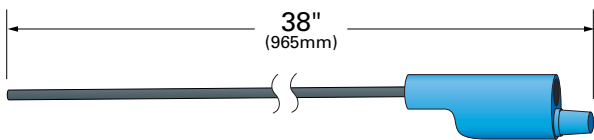

### SLIM-LINE UNDER-LAMP FEMALES (CUT-TO-FIT®)

Abrasion-resistant double-jacketed wire lengths with molded-on Slim-Line under-lamp double females includes sealing boot for crimp-on bullet connectors • Blunt-cut, Cut-To-Fit® wires are black

67301 14-Gauge, 3' 2" (38")

VMRS Code: 034-004-023

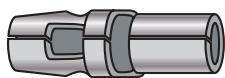

99500-3

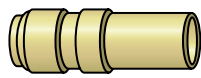

99501-3

### CRIMP-ON .180 BULLET TERMINALS

99500-3 Field Service Terminal for 14-Gauge Wire  
99501-3 Field Service Terminal for 12-Gauge Wire

VMRS Code: 034-004-023

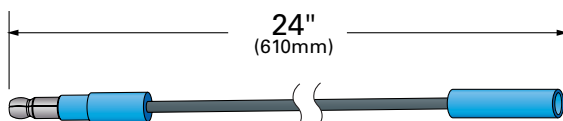

### STANDARD MALE TO SLIM-LINE UNDER-LAMP FEMALE

Rear tracking lamp jumper

66170 2' (24")

VMRS Code: 034-004-023

### STANDARD MALE TO STANDARD FEMALE

66100 - License lamp jumper (as shown) • 66101 - Intermediate turn signal jumper, use with 66200 from front receptacle

- 66100 4' 4" (50")
- 66101 28' 3" (339")

VMRS Code: 034-004-023

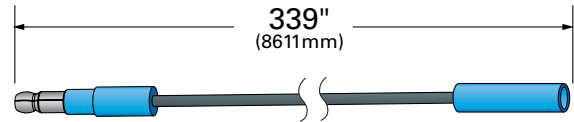

### SLIM-LINE UNDER-LAMP MALE TO STANDARD FEMALE

Jumper to access auxiliary drop-out on rear sill harness

- 66110 5' (60")

VMRS Code: 034-004-042

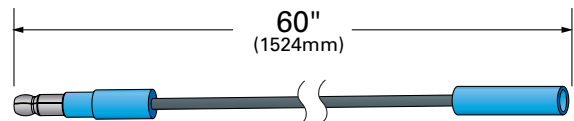

### SLIM-LINE UNDER-LAMP MALE TO SLIM-LINE UNDER-LAMP FEMALE

- 66162 Intermediate Side Marker Crossover Jumper, 8' 9" (105")

VMRS Code: 034-004-023

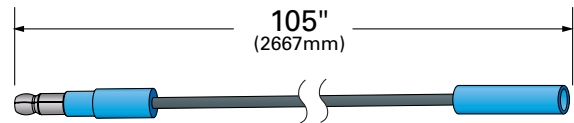

### SLIM-LINE UNDER-LAMP MALE TO SLIM-LINE UNDER-LAMP FEMALE

- 66160 Multiple ID lamp jumper, 1' (12")
- 66124 Front marker and rear marker lamp jumper, 2' 6" (30")
- 66161 Front lower side marker from front receptacle.  
Use with 66190, 4' 7" (55")
- 66125 Marker lamp jumper, 7' (84")
- 66123 Marker lamp jumper, 10' 9" (129")
- 66163 Front upper clearance / marker from front receptacle.  
Use with 66190, 12' 8" (152")
- 66122 Marker lamp jumper 16' (192")
- 66113 Clearance lamp jumper 26' 11" (323")

VMRS Code: 034-004-023

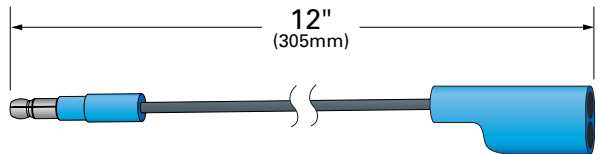

### BLUNT-CUT TO DOUBLE SLIM-LINE UNDER-LAMP FEMALE

- 66190 Wire into front receptacle terminals, 8" blunt cut

VMRS Code: 034-004-023

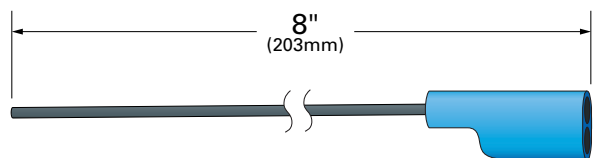

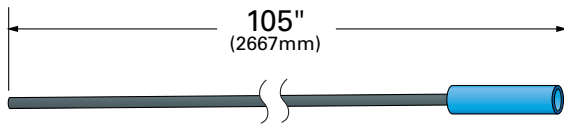
**BLUNT-CUT TO STANDARD FEMALE**

**66200** Wire into front receptacle terminals, 8" blunt cut

**VMRS Code:** 034-004-023

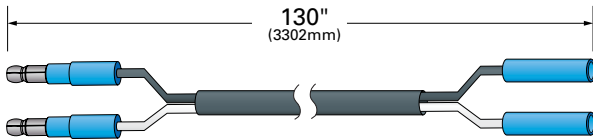
**TWO STANDARD MALES TO TWO SLIM-LINE UNDER-LAMP FEMALES**

66220 - Use the 5306 combination clearance / marker and auxiliary stop / turn signal lamp, use with 66400 when triple-ID / Auxiliary stop is located on upper rail, 10' 10" (130") • Wire is 14 gauge

**66220** ID / auxiliary stop jumper

**66121** Midturn and marker lamp harness, 30' (360")

**VMRS Code:** 034-004-023

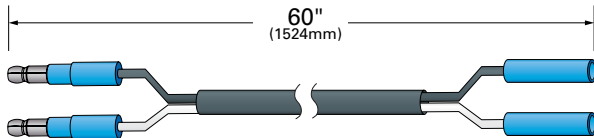
**TWO SLIM-LINE MALES TO TWO SLIM-LINE UNDER-LAMP FEMALES**

**66221** Marker lamp or ABS fault lamp, 5' (60")

**66222** Jumper, 8' (96")

**66164** Jumper, 8' 9" (105")

**VMRS Code:** 034-004-023

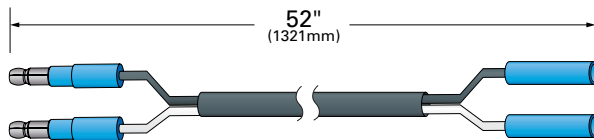
**TWO STANDARD MALES TO TWO STANDARD FEMALES**

**66133** Marker lamp jumper, 4' 4" (52")

**VMRS Code:** 034-004-023

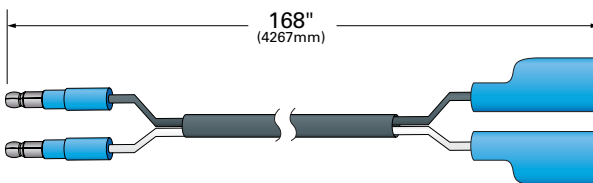
**TWO STANDARD MALES TO TWO DOUBLE FEMALES**

**66171** Marker lamp jumper, 14' (168")

**66145** Marker lamp jumper, 26' (312")

**VMRS Code:** 034-004-023

**TWO SLIM-LINE MALE TO TWO DOUBLE FEMALES**

- 66165** Marker lamp jumper, 1' (12")
- 66155** Marker lamp jumper, 2' 6" (30")
- 66154** Marker lamp jumper, 4' 7" (55")
- 66153** Marker lamp jumper, 7' (84")
- 66152** Marker lamp jumper, 10' 9" (129")
- 66151** Marker lamp jumper, 12' 8" (152")
- 66150** Marker lamp jumper, 16' (192")
- 66135** Marker lamp jumper, 26' 11" (323")

VMRS Code: 034-004-023

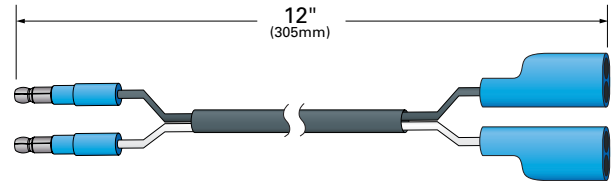

**7-CONDUCTOR CABLE:  
 (SAE J1067™ AND J560™)**

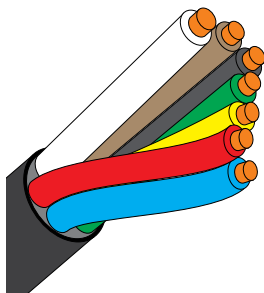

- White Ground (10 ga.)
- Brown Tail and license lamp, and clearance lamps (12 ga.)
- Black Clearance, sidemarker, and identification lamps (12 ga.)
- Yellow Left turn signal lamp (12 ga.)
- Green Right turn signal lamp (12 ga.)
- Red Stop lamps (12 ga.)
- Blue Auxiliary circuit (12 ga.)

**HEAVY DUTY 7-CONDUCTOR CABLE SYSTEM:  
 (SAE J1067™ AND J560™)**

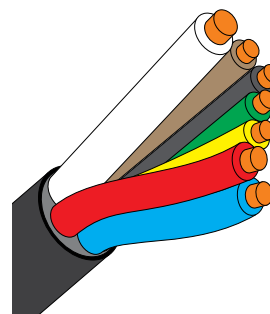

- White Ground (8 ga.)
- Brown Tail and license lamp, and clearance lamps (12 ga.)
- Black Clearance, sidemarker, and identification lamps (12 ga.)
- Yellow Left turn signal lamp (12 ga.)
- Green Right turn signal lamp (12 ga.)
- Red Stop lamps (10 ga.)
- Blue Auxiliary circuit (10 ga.)



## WIRE SIZES

No matter what the variety, it's critical to choose the correct wire size for the application. The key information required is the length of wire needed, often referred to as the length of run, and the current load that the conductor is expected to carry in use. Knowing the "length and load" characteristics will take the guesswork out of the choice.

Voltage drop, caused by current draw, is the primary consideration when selecting the proper conductor size. Every conductor has a certain amount of resistance per foot. The longer the distance, the greater the resistance in the circuit. The greater the resistance, the higher the voltage drop caused by the same current. This relationship is defined by Ohm's law (Voltage = Current x Resistance). As distance from the power source increases, there is less voltage available to "push" the current through the

wire. This causes the current to drop. There is also heat buildup as the resistance increases, which also lessens the amount of current flow.

In low-voltage systems, such as vehicles, even a small drop in voltage can have a serious effect on the amount of light a lamp puts out. There's a simple solution. As you get further away from the power source, make the conductor larger. A larger conductor means less resistance.

Using the Wire Size Chart, first find the load in amps on the left edge of the chart. Then find the length of run across the top of the chart. Read down that column until it intersects with the amp load line. The point at which they cross indicates the correct wire size for the job.

| Wire Size Chart |                 |                 |                                     |               |               |               |               |               |               |               |               |               |
|-----------------|-----------------|-----------------|-------------------------------------|---------------|---------------|---------------|---------------|---------------|---------------|---------------|---------------|---------------|
| 12V<br>(AMP)    | 24V             | 48V             | Length of Wire (most distant light) |               |               |               |               |               |               |               |               |               |
|                 |                 |                 | 10'                                 | 20'           | 30'           | 40'           | 50'           | 60'           | 70'           | 80'           | 90'           | 100'          |
| Load in<br>Amps | Load in<br>Amps | Load in<br>Amps | Wire<br>Gauge                       | Wire<br>Gauge | Wire<br>Gauge | Wire<br>Gauge | Wire<br>Gauge | Wire<br>Gauge | Wire<br>Gauge | Wire<br>Gauge | Wire<br>Gauge | Wire<br>Gauge |
| 1               | 2               | 4               | 18                                  | 18            | 18            | 18            | 18            | 18            | 18            | 18            | 18            | 18            |
| 1.5             | 3               | 6               | 18                                  | 18            | 18            | 18            | 18            | 18            | 18            | 18            | 18            | 18            |
| 2               | 4               | 8               | 18                                  | 18            | 18            | 18            | 18            | 18            | 18            | 16            | 16            | 16            |
| 3               | 6               | 12              | 18                                  | 18            | 18            | 18            | 18            | 16            | 16            | 16            | 14            | 14            |
| 4               | 8               | 16              | 18                                  | 18            | 18            | 16            | 16            | 16            | 14            | 14            | 14            | 12            |
| 5               | 10              | 20              | 18                                  | 18            | 18            | 16            | 14            | 14            | 14            | 12            | 12            | 12            |
| 6               | 12              | 24              | 18                                  | 18            | 16            | 16            | 14            | 14            | 12            | 12            | 12            | 10            |
| 7               | 14              | 28              | 18                                  | 18            | 16            | 14            | 14            | 12            | 12            | 12            | 12            | 10            |
| 8               | 16              | 32              | 18                                  | 16            | 16            | 14            | 12            | 12            | 12            | 10            | 10            | 10            |
| 10              | 20              | 40              | 18                                  | 16            | 14            | 12            | 12            | 12            | 10            | 10            | 10            | 10            |
| 11              | 22              | 44              | 18                                  | 16            | 14            | 12            | 12            | 10            | 10            | 10            | 10            | 8             |
| 12              | 24              | 48              | 18                                  | 16            | 14            | 12            | 12            | 10            | 10            | 10            | 8             | 8             |
| 15              | 30              | 60              | 18                                  | 14            | 12            | 12            | 10            | 10            | 10            | 8             | 8             | 8             |
| 18              | 36              | 72              | 16                                  | 14            | 12            | 10            | 10            | 8             | 8             | 8             | 8             | 8             |
| 20              | 40              | 80              | 16                                  | 12            | 12            | 10            | 10            | 8             | 8             | 8             | 8             | 6             |

- A) DETERMINE THE TOTAL WIRE LENGTH FROM THE POWER SOURCE TO THE MOST DISTANT POINT IN THE CIRCUIT.  
 B) DETERMINE THE TOTAL ELECTRICAL LOAD ON THE CIRCUIT.  
 C) FIND THE LOAD ALONG ONE EDGE OF THE CHART DEPENDING ON THE VEHICLE VOLTAGE IN QUESTION, TAKING THE NEXT HIGHER LOAD IF THE INDICATED LOAD FALLS BETWEEN TWO POINTS ON THE CHART.  
 D) FIND THE CABLE LENGTH REQUIRED ON THE TOP OF THE CHART, TAKING THE NEXT HIGHER LENGTH (IF EXACT LENGTH IS NOT CITED).  
 E) AT THE INTERSECTION OF THE LENGTH AND LOAD COLUMN, READ THE MINIMUM SIZE WIRE REQUIRED FOR THAT PARTICULAR CIRCUIT.

## WIRE GAUGES

Conductors may be single strand or a group of strands. Stranded conductors are preferred in heavier gauges because they are more flexible and easier to work with than a comparable single strand conductor.

Comparing stranded cable sizes is simple. Stranded cable is compared using a numerical system. For example, 18/24 indicates that the conductor consists of 18 strands of 24-gauge wire. Similarly 12/12 refers to 12 strands of 12-gauge wire.

Gauge refers to the size of the conductor in a wire. The higher the gauge number, the smaller the wire. For example, an 18-gauge wire is smaller than a 12-gauge wire. And a 4-gauge wire has more than twice the diameter of a 10-gauge wire.

When the wire size gets larger, the number reaches #0 gauge or 1/0 (one aught). Additional zeros refer to larger sizes. The next larger size above 1/0 is #00 or 2/0 (two aught).

The capacity of a wire reflects the ability it has to carry electrical current. For example, over a distance of 50 feet, a 12-gauge wire can safely carry 10 amps. Over the same distance a 16-gauge wire can carry 3 amps. Choosing the size wire is made easier using a wire size chart.

Just remember the thicker the wire, the smaller the amperage loss.

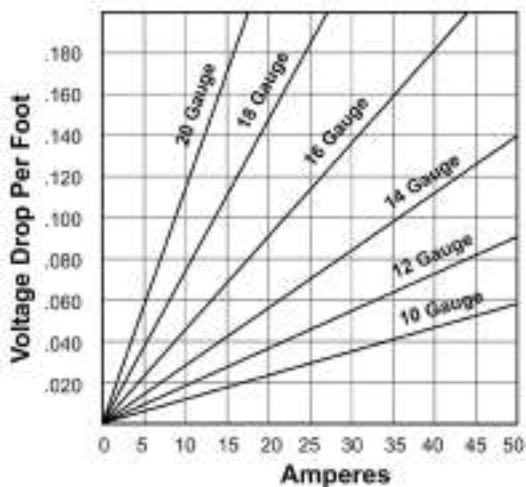

## Wire Gauge Chart

| GAUGE | S.W.G. | A.W.G. (inches) | A.W.G. (mm) | Actual Size (A.W.G.) |
|-------|--------|-----------------|-------------|----------------------|
| 00    | 0.348  | 0.368           | 9,266       | ●                    |
| 0     | 0.324  | 0.325           | 8,252       | ●                    |
| 1     | 0.300  | 0.289           | 7,348       | ●                    |
| 2     | 0.276  | 0.258           | 6,543       | ●                    |
| 3     | 0.252  | 0.229           | 5,827       | ●                    |
| 4     | 0.232  | 0.204           | 5,189       | ●                    |
| 5     | 0.212  | 0.182           | 4,621       | ●                    |
| 6     | 0.192  | 0.162           | 4,115       | ●                    |
| 7     | 0.176  | 0.144           | 3,665       | ●                    |
| 8     | 0.160  | 0.129           | 3,264       | ●                    |
| 9     | 0.144  | 0.114           | 2,906       | ●                    |
| 10    | 0.128  | 0.102           | 2,588       | ●                    |
| 11    | 0.116  | 0.091           | 2,304       | ●                    |
| 12    | 0.104  | 0.081           | 2,052       | ●                    |
| 13    | 0.092  | 0.072           | 1,829       | ●                    |
| 14    | 0.080  | 0.064           | 1,628       | ●                    |
| 15    | 0.072  | 0.057           | 1,450       | ●                    |
| 16    | 0.064  | 0.051           | 1,291       | ●                    |
| 17    | 0.056  | 0.045           | 1,150       | ●                    |
| 18    | 0.048  | 0.040           | 1,024       | ●                    |
| 19    | 0.040  | 0.036           | 0,912       | ●                    |
| 20    | 0.036  | 0.032           | 0,813       | ●                    |
| 21    | 0.032  | 0.029           | 0,724       | ●                    |
| 22    | 0.028  | 0.025           | 0,643       | ●                    |

A.W.G = American Wire Gauge

S.W.G = Imperial Standard Wire Gauge  
 (British legal standard)

# 13

## PIGTAILS

*SPIRALES DE RACCORD*

*CONECTORES*

# ULTRA-BLUE-SEAL® MOLDED PLUGS COMMONLY USED IN TRAILER HARNESS APPLICATIONS



**MALE PIN**

- Double Seal
- Grease slot



**90° MALE PIN**

- Double Seal
- Grease slot



**FEMALE PIN - PL3**

- Double Seal
- 90°



**CLEARANCE MARKER**

- Designed to fit surface mounting brackets



**MARKER LAMP PLUG - PL10**

- Double Seal
- Available in flow-through applications



**THIN LINE PLUG**

- Double Seal
- Grease slot
- Available in flow-through applications



**SENTRY LAMP**

- Available in 2-way and 3-way configurations



**HARD SHELL**

- Available in 2-way and 3-way configurations



**TURTLEBACK PLUG**

- Double Seal
- Available in flow-through applications



**.180 SLIMLINE AND STANDARD OPTIONS**

- Available in flow-through applications

## GROTE'S DOUBLE SEAL ADVANTAGE

The Double Seal is a molded-in circular ring in each connector that corresponds to a mating ring on the lamp. The inner sealing ring covers the terminal area. The outer ring double seals around the outside area of the lamp plug connection.



## GROTE'S MALE PIN TERMINATION

Center grease reservoir, plus side locking tabs on the lamp protect against hydraulic pressure forcing connection open.





66930



66931



67001



66850



66851



66801



67050



66840



66800



66980



66981



66982

## THIN-LINE LED PIGTAILS

Factory-molded plugs for use with ULTRA-BLUE-SEAL® trailer wiring system

- Uses patented double-seal protection
- Grease grooves for additional sealing protection
- Slim-Line .180 male bullets

**66930** 5" Long, Chassis Ground System

**66931** 6" Long, Ground Return

VMRS Code: 034-004-042

## SEALED MARKER LAMP PIGTAILS

Factory-molded plugs for use with ULTRA-BLUE-SEAL® trailer wiring system

- Double seal resists corrosion
- Fits 2" and 2 1/2" round and beehive-style LED and incandescent lamps
- Slim-Line .180 male bullets

### DOUBLE SEAL:

**67001** 6" Long, Ring Terminal Ground, Blunt Cut Wire

**66850** 6" Long, Chassis Ground

**66851** 6" Long, Ground Return

### SINGLE SEAL:

**66801** 6" Long, Ground Return

**67050** 6" Long, Ring Terminal Ground, Blunt Cut Wire

**67050-5** 6" Long, Ring Terminal Ground, Blunt Cut Wire

**66840** 6" Long, Chassis Ground, Standard .180 Male

**66800** 6" Long, Chassis Ground, Slim-Line .180 Male

RETAIL

VMRS Code: 034-004-042

## CLEARANCE / MARKER PIGTAILS

Factory-molded plugs for use with ULTRA-BLUE-SEAL® trailer wiring system

- Fits 4674 series clearance / marker lamps, and 4709 and 6029 / 6030 license and utility lamps
- Pigtail designed to be integral part of mounting bracket (43780)

**66980** 6" Long, Chassis Ground, Slim-Line .180 Male

**66981** 6" Long, Universal Replacement, Blunt Cut, Ring Terminal Grommet

**66982** 8" Long, Ground Return

VMRS Code: 034-004-042



### MARKER LAMP PIGTAIL

Fits all Grote® 2-bulb marker lamps with flag terminals, including 4526-, 4546-, 4593-, 4630-, 4678- and 4679- series lamps

**67120** 7 3/4" Long, .180 Slim-Line Male

VMRS Code: 034-004-023



67120

### SEALED, ECONOMY CLEARANCE/ MARKER LAMP PIGTAIL

Fits 4607- series lamps

**66360** 6 3/4" Long w/ 3/8" Wire Strip

VMRS Code: 034-002-031



66360

### TURTLEBACK® II DOUBLE-SEAL LAMP PIGTAILS

Factory-molded plugs for use with ULTRA-BLUE-SEAL® trailer wiring system  
 • Pigtail for 4680-, 4684-, 4686- and 4687- series lamps • All connections fit under lamps

- 66910** 6" Long, Chassis Ground, Slim-Line .180 Male
- 66911** 6" Long, Ground Return, Standard .180 Male
- 67070** 2 1/2" Long, Ground Wire, Standard .180 Male
- 67071** Two-Wire, Standard .180 Male

VMRS Code: 034-004-042



66910



66911



67070

67071

### SENTRY LAMP PIGTAILS

Factory-molded plugs for use with ULTRA-BLUE-SEAL® trailer wiring system  
 • Sealed plug-in pigtail for 5206-, 5202-, and 5306- lamps • O-ring helps prevent moisture and corrosion

- 66900** 6" Long, Chassis Ground, Slim-Line .180 Male, 3 1/2" Ground, Star Ring Terminal
- 66904** 6" Long, Ground Return, Slim-Line .180 Male
- 66905** 6" Long, Chassis Ground, Slim-Line .180 Male

VMRS Code: 034-004-042



66900



66904



66905



66902

### SENTRY HIGH-MOUNT STOP PIGTAIL

Fits 54012 lamp • Sealing ring to lamp base • O-ring resists moisture and corrosion

**66902** 6" Long, Slim-Line .180 Male, 3" Ground, Star Ring Terminal

VMRS Code: 034-004-042



66870

### HIGH-MOUNT STOP LAMP PIGTAIL

Factory-molded plugs for use with the ULTRA-BLUE-SEAL® trailer wiring system • Fits 4925 series lamps for use in HMSL applications

**66870** 12 1/2" Long, Slim-Line .180 Male

**VMRS Code:** 034-004-042



66815

### STOP/TAI/TURN THREE-WIRE PLUG-IN PIGTAILS FOR MALE PIN LAMPS

Dual function for S/T/T lamps • O-ring seal resists moisture and corrosion • Quality ULTRA-BLUE-SEAL® construction • Grease grooves for additional sealing protection

**66815** 6" Long, Ground Return, Slim-Line .180 Male

**66841** 8" Long, Chassis Ground, Slim-Line .180 Male

**67002** 11" Long, Chassis Ground, Blunt Cut Wire

**VMRS Code:** 034-002-031



66841



67002



66816

### STOP/TAI/TURN THREE-WIRE 90° PLUG-IN PIGTAILS FOR MALE PIN LAMPS

Dual function for S/T/T lamps • O-ring seal resists moisture and corrosion • 90° plug for reduced clearance applications • Quality ULTRA-BLUE-SEAL® construction • Grease grooves for additional sealing protection

**66816** 6" Long, Ground Return System, 90° Plug, Slim-Line .180 Male

**66845** 8" Long, Chassis Ground, 90° Plug, Slim-Line .180 Male

**67005** 11" Long, Chassis Ground, 90° Plug, Blunt Cut Wires

**VMRS Code:** 034-002-031



66845



67005



67013

### SINGLE FUNCTION TWO-WIRE PLUG-IN PIGTAILS FOR MALE PIN LAMPS

Straight-in pigtail • Single function • O-ring seal resists moisture and corrosion • Quality ULTRA-BLUE-SEAL® construction • Grease grooves for additional sealing protection

**67013** 11" Long, Chassis Ground, Blunt Clut Wire

**66842** 10" Long, Chassis Ground, Slim-Line .180 Male

**VMRS Code:** 034-002-031



66842

### SINGLE-FUNCTION TWO-WIRE 90° PLUG-IN PIGTAILS FOR MALE PIN LAMPS

Factory-molded plugs for use with quality ULTRA-BLUE-SEAL® trailer wiring system • 90° plug for reduced clearance applications • Single function  
• O-ring seal resists moisture and corrosion • Grease grooves for additional sealing protection

- 66846** 10" Long, Chassis Ground, 90° Plug, Slim-Line .180 Male
- 67016** 11" Long, Chassis Ground, 90° Plug, Blunt Cut Wires

VMRS Code: 034-002-031



### STOP/TAIL/TURN THREE-WIRE PLUG-IN PIGTAILS FOR FEMALE PIN LAMPS

Dual function for S/T/T lamps • Factory molded plugs for use with ULTRA-BLUE-SEAL® trailer wiring system

- 66812** 6" Long, Chassis Ground, Slim-Line .180 Male
- 66825** 8" Long, Ground Return, Slim-Line .180 Male
- 67000** 11 1/2" Long, Chassis Ground, Blunt Cut Wires

VMRS Code: 034-002-031

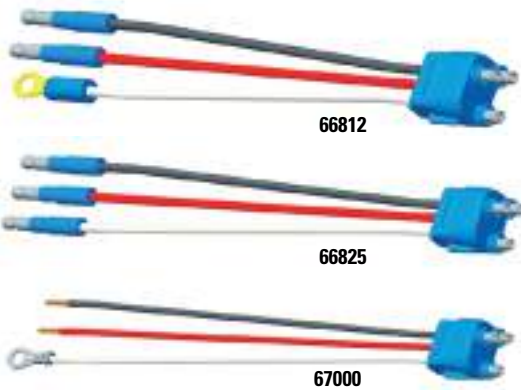

### STOP/TAIL/TURN THREE-WIRE 90° PLUG-IN PIGTAILS FOR FEMALE PIN LAMPS

Factory-molded plugs for use with ULTRA-BLUE-SEAL® trailer wiring system  
• Dual function for S/T/T lamps

- 66811** 18" Long, Chassis Ground, Slim-Line .180 Male, Star Ring Terminal
- 66843** 18" Long, Chassis Ground, Blunt Cut Wires, Star Ring Terminal
- 66844** 18" Long, Ground Return, Slim-Line .180 Male

VMRS Code: 034-002-031

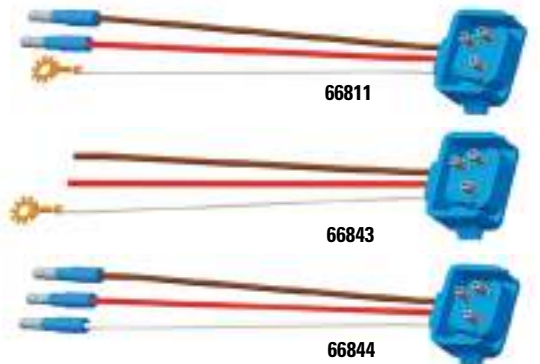

### UNIVERSAL 3-WIRE 90° PLUG-IN PIGTAIL FOR FEMALE-PIN LAMPS

90° construction for reduced clearance applications • Dual function for S/T/T lamps • Mates to Grote® and competitive lamps with female termination

- 67090** 13" Long, Chassis Ground, 90° Plug, Blunt Cut Wires
- 67090-5** 13" Long, Chassis Ground, 90° Plug, Blunt Cut Wires **RETAIL**

VMRS Code: 034-002-031



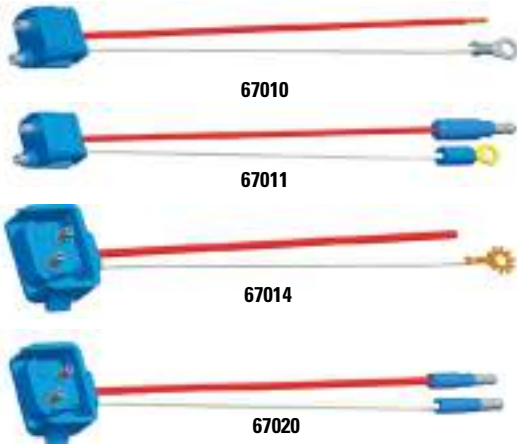

**TWO-WIRE PLUG-IN PIGTAILS FOR FEMALE-PIN LAMPS**

Factory-molded plugs for use with ULTRA-BLUE-SEAL® trailer wiring system  
 • Single function • Includes dummy pin to help guide the pigtail into lamp

**STRAIGHT:**

- 67010** 11 1/2" Long, Chassis Ground, Blunt Cut
- 67011** 10 1/4" Long, Chassis Ground, Standard .180 Male

**90° PLUG:**

- 67014** 10" Long, Chassis Ground, Blunt Cut
- 67020** 10" Long, Ground Return, Slim-Line .180 Male

VMRS Code: 034-002-031



**TRIPLE-LAMP ID HARNESSSES**

Designed for use with ULTRA-BLUE-SEAL® wiring system • Factory-molded plugs resist moisture and corrosion • Slim-Line .180 male terminations at power end

- 66111** 54" Long, Universal Triple-ID Jumper (31"x12"x12")
- 66932** 60" Long, LED Triple-ID Jumper (36"x12"x12")

VMRS Code: 034-004-023 - 66111  
 034-004-042 - 66932

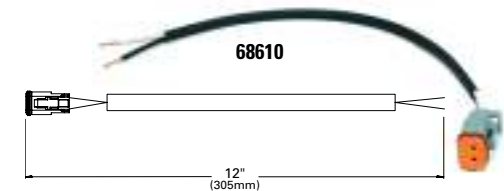

**DEUTSCH® CONNECTOR**

Mates with Trilliant® Work Lamps and competitive lamps using Deutsch® connectors

- 68010** Deutsch® to Packard®
- 68020** Packard® to Deutsch®
- 68030** Deutsch® to Packard® (Hard Shell SuperSeal)
- 68060** Packard® to Packard®
- 68610** 12" Long, Blunt Cut Wires

VMRS Code: 034-002-031

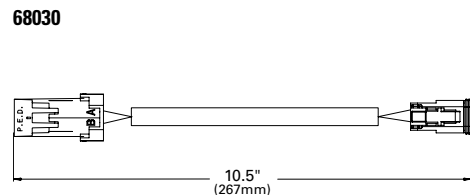
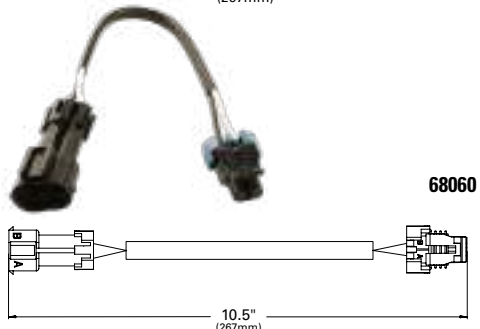
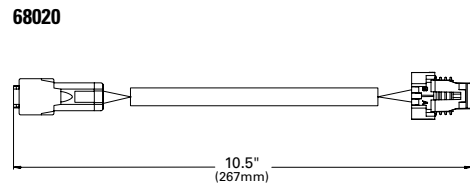

### HARD SHELL SUPERSEAL CONNECTOR

Mates with Trilliant® Work Lamps and competitive lamps using AMP® superseal connectors

**68580** 9" Long, Blunt Cut Wires

VMRS Code: 034-004-042



### HARD SHELL CONNECTOR PIGTAILS

Mates with Grote® and competitive lamps using Hard Shell SuperSeal 1.5 series connectors

**DUAL FUNCTION:**

**66861** 11" Long, Chassis Ground, Blunt Cut Wires

**SINGLE FUNCTION:**

**66862** 11" Long, Chassis Ground, Blunt Cut Wires

VMRS Code: 034-002-031

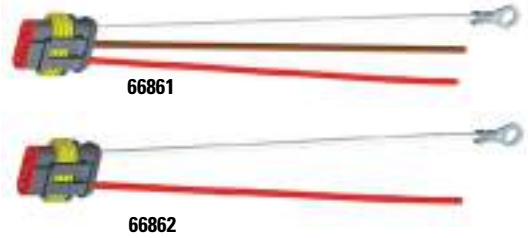

### PACKARD® CONNECTOR PIGTAIL

Sealed plug-in style pigtail for Grote® Hybrid Midturn / Marker LED lamp

**66826** 6" Long, Slim-Line .180 Males

VMRS Code: 034-002-031



### METRI-PACK® PLUG-IN SEALED PIGTAIL

Fits either 4- or 5-wire applications • Fits 5370-, 5371-, 5372- and 5376- series lamps

**68680** 20" Long, Sealed, Blunt Cut Wires

VMRS Code: 034-002-031



### TWO-LAMP 9" Y ADAPTER PIGTAILS

Accommodates 6-lamp systems • Molded termination avoids moisture and corrosion buildup • For use with 4" round and oval S/T/T lamps  
• Retrofits to superior Grote® male pin LED lamps without the need for new wiring

**90° PLUG:**

**66814** 9" Long, Adapter, Female-to-Male Pin

**STRAIGHT:**

**66810** 9" Long, Adapter, Female-to-Female Pin

**66813** 9" Long, Adapter, Male-to-Male Pin

VMRS Code: 034-002-031

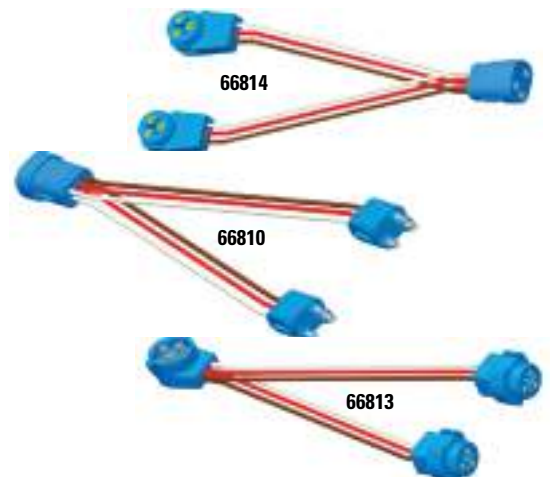



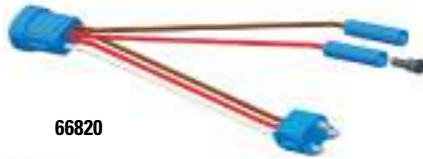

66820

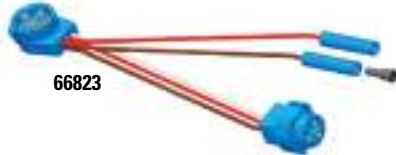

66823

## MIDTURN ADAPTER PIGTAILS

Factory-molded plugs for use with ULTRA-BLUE-SEAL® trailer wiring system

- For use with 4" round and oval S/T/T lamps
- 6" midturn adapter harness
- Dummy plug in brown female .180 receptacle

**66820** Adapter, Female-to-Female Pin, (2) Additional Standard .180 Receptacles

**66823** Adapter, Male-to-Male Pin, (2) Additional Standard .180 Receptacles

VMRS Code: 034-002-031



66830



66831



66836

## ADAPTER PLUGS

Includes female-to-male pin lamp termination, and male-to-female pin lamp termination

- For use with 4" round and oval S/T/T lamps

**66830** 6" Long, Female Pin to Male Pin Lamp Termination

**66831** 6" Long, Male Pin to Female Pin Lamp Termination

**66836** 6" Long, Female Pin to 90° Male Pin Lamp Termination

VMRS Code: 034-002-031



67006



66860

## ADAPTER PLUGS FOR HARD SHELL CONNECTORS

For use with 4" round and oval S/T/T lamps

### COMPETITIVE HARNESS TO MALE PIN:

**67006** 6" Long, Hard Shell to Male Pin Connector

### FEMALE PIN HARNESS TO AMP CONNECTOR:

**66860** 6" Long, Female Pin to Hard Shell Connector

VMRS Code: 034-002-031



66863



66864



66865

## COMBO PIGTAILS

For 4" integrated Back-up Lamp

### 4" WITH INTEGRATED BACK-UP

**66863** Converter for Male Pin Lamps (10" Long)

**66864** Converter for Female Pin Lamps (10" Long)

**66865** Converter for Hard Shell Lamps (10" Long)

**01-6686-E3** Ring Terminals to Lamp Termination

### 4" W/O INTEGRATED BACK-UP

**66442** Converter for Male Pin Lamps, 10"

**66443** Converter for Female Pin Lamps, 10"

**66444** Converter for Hard Shell Lamps, 10"

VMRS Code: 034-002-031

### REPLACEMENT LAMP SOCKET PIGTAILS

Ensures positive bulb contact in all types of weather • Exceeds all existing automotive requirements • Heavy gauge thermoplastic wire with brass contacts, terminals and flags

**DOUBLE CONTACT:**

**68130** 7 1/2" Long

**68150** 6 1/2" Long

**SINGLE CONTACT:**

**68170** 9 1/2" Long

**VMRS Code:** 034-004-023 - 68110  
034-004-042 - 68130, 68150, 68080, 68170

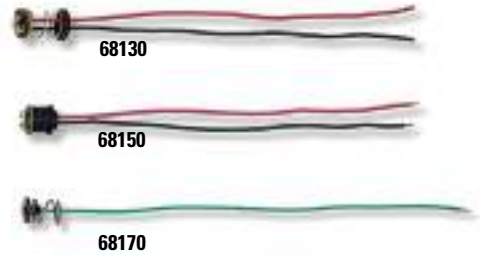

### TWIST-IN SOCKET PIGTAIL

Includes 194 bulb • Fits 46002, 46003, 46913, 45662, 45712 and 45713 marker lamps

**68380** 9 1/2" Long, Socket, Blunt Cut Wires

**Volts / Amp:** 12V / .27A  
**VMRS Code:** 034-004-042



Deutsch® is a registered trademark of TE Connectivity Corporation.; Packard® is a registered trademark of DELPHI TECHNOLOGIES, INC.; Metri-Pack® is a registered trademark of Aptiv Technologies Limited COMPANY BARBADOS;

All product and company names are trademarks™ or registered® trademarks of their respective holders. Use of them does not imply any affiliation with or endorsement by them.



**NEED HELP FINDING  
THE RIGHT PRODUCT?**

GROTE® CUSTOMER SERVICE  
IS JUST A PHONE CALL AWAY

**800-628-0809**



# 14

## MOUNTING OPTIONS

*OPTIONS DE FIXATION*

*OPCIONES DE MONTAJE*

### SPACER WIRE GUIDE

For use with LED Radius Light 64M11-5 or LED Fairing Light 64M21-5  
 • Designed for extended installation and wire routing  
 • Install with two #8 fasteners (not included)

**49501-3** Spacer and Wire Guide - Bulk Pack

**VMRS Code:** 034-006-034

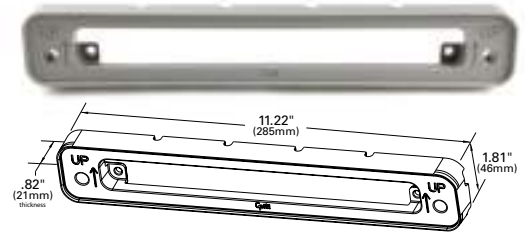

### GASKET

To be used when surface mounting the LED Radius Light 64M11-5 or LED Fairing Light 64M21-5

**49511-3** Gasket - Bulk Pack

**VMRS Code:** 034-001-122

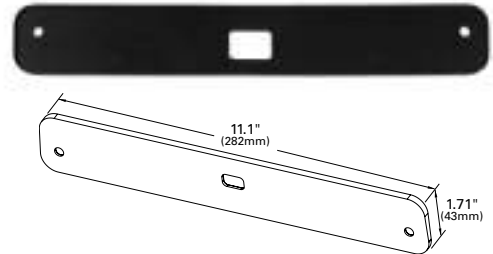

### SNAP-IN COVER PLATES

Cover plate is held in place by snap tabs instead of screws for fast and easy installation • For use in retrofit of Grote S/T/T w/ integrated back-up lamps

- 94380-4** 4" Round Gray, Pair Pack
- 94382-4** 4" Round Black, Pair Pack
- 94390-4** 6" Oval Gray, Pair Pack
- 94392-4** 6" Oval Black, Pair Pack

**Material:** Polycarbonate  
**VMRS Code:** 034-022-006



### HOODED MICRONOVA® DOT GROMMET

Fits MicroNova® Dot lamps • For plate thickness to 1/4"

**94360** Black

**Material:** PVC  
**Finish:** Black  
**VMRS Code:** 034-004-058

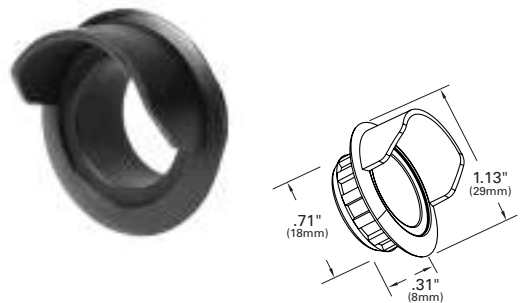

### MICRONOVA® SECURITY PLATE

Installs over grommet-mounted MicroNova® Dot without impeding light output performance • Use stainless steel rivets (.119 rivet) or screws (not included) to mount directly to the vehicle • Not for use with 94360

**42063** Stainless Steel

**Material:** Stainless Steel  
**Finish:** Stainless Steel  
**VMRS Code:** 034-004-036





### MICRONOVA® OVAL BEZEL

- Plate mounts directly to vehicle with stainless steel rivets or screws
- Provides an additional layer of theft deterrence
- Prevents lamp rotation when installed

**42343** Stainless Steel Bezel

**Material:** Stainless Steel

**Finish:** Stainless Steel

**VMRS Code:** 034-004-043



### RECESSED MOUNTING GROMMET FOR 2" ROUND LAMPS

Requires 2 5/16" mounting hole • Fits panel thickness up to 1/4"

**92120** Open Grommet

**92150** Closed Back Grommet

#### KITS:

**94100** Open Grommet (92120 + 67050)

**Material:** PVC

**Finish:** Black

**VMRS Code:** 034-004-058 - 92120

034-004-027 - 92150

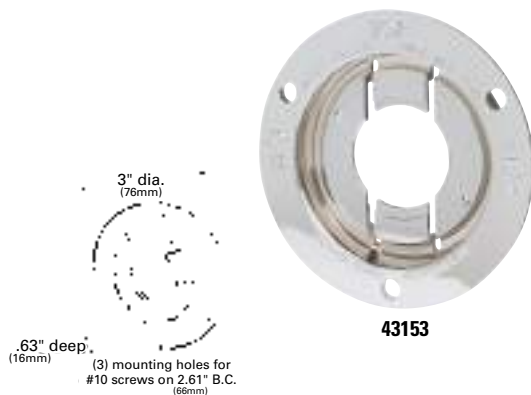

### THEFT-RESISTANT MOUNTING FLANGE FOR 2" ROUND LAMPS

Patented twist-in locking system keeps lamp from backing out • Ideal for LED lighting • For use with 2" LED and incandescent lamps • Requires 2 1/4" mounting hole

**43150** Gray, Polycarbonate

**43152** Black, Polycarbonate

**43153** Chrome-Plated, ABS

**Material:** Polycarbonate/ABS

**Finish:** Gray/Black/Chrome

**VMRS Code:** 034-004-036



### SURFACE MOUNT BRACKET WITH GROMMET FOR 2" ROUND LAMPS

4 1/4" mounting screw hole spacing

**93760** Gray

**Material:** Polycarbonate

**Finish:** Gray

**Grommet:** 92120

**VMRS Code:** 034-004-036



**2" AND 2½" LICENSE LAMP MOUNTING BRACKET**

Anti-glare shield eliminates stray light from distracting following motorists

**43040** White

**Material:** Polycarbonate  
**Finish:** White  
**VMRS Code:** 034-004-036



**RECESSED MOUNTING GROMMET FOR 2½" ROUND LAMPS**

- Requires 2 25/32" hole
- Fits panel thickness up to 1/8"

**91400** Open Grommet  
**92070** Closed-Back Grommet

**KITS:**

**94010** Open Grommet (91400 + 67050)

**Material:** PVC  
**Finish:** Black  
**VMRS Code:** 034-004-058



**RECESSED MOUNTING GROMMET FOR 2½" ROUND LAMPS**

- Requires 3" hole
- Fits panel thickness up to 1/4"

**91410** Open Grommet

**KITS:**

**94000** Open Grommet (91410 + 67050)

**Material:** PVC  
**Finish:** Black  
**VMRS Code:** 034-004-058



**45° ANGLED BEVELED-EDGE RECESSED MOUNTING GROMMET FOR 2½" ROUND LAMPS**

Fits 2 3/4" hole • Open back fits panel thickness up to 3/16", closed back fits up to 3/8"

**91880** Open Grommet  
**92920** Closed-Back Grommet

**Material:** PVC  
**Finish:** Black  
**VMRS Code:** 034-004-058

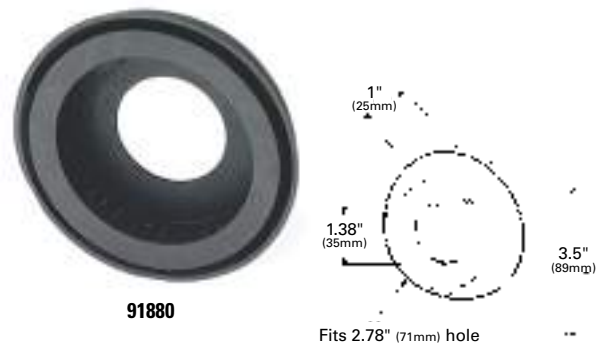



## SURFACE MOUNT GROMMET FOR 2 1/2" ROUND LAMPS

Protective brass eyelets for mounting screw

**91890** Open Grommet

**Material:** PVC

**Finish:** Black

**VMRS Code:** 034-004-058

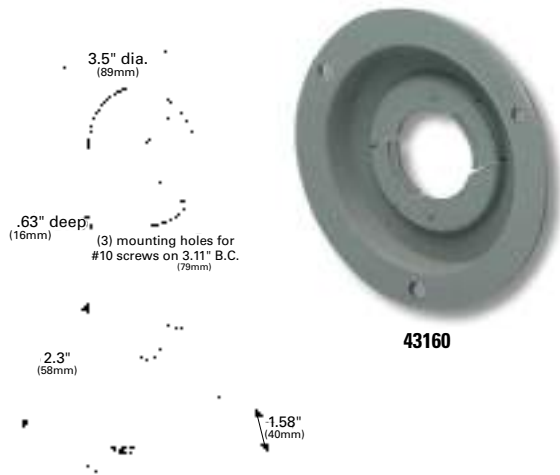

**43160**

## THEFT-RESISTANT MOUNTING FLANGE FOR 2 1/2" ROUND LAMPS

Patented twist-in locking system keeps lamp from backing out • Ideal for LED lighting • Fits 2 1/2" LED and incandescent lamps • Requires 2 5/8" mounting hole

### MOUNTING FLANGE:

**43160** Gray, Polycarbonate

**43162** Black, Polycarbonate

**43163** Chrome-Plated, ABS

### PIGTAIL RETENTION CAP:

**93670** Gray

**Material:** Polycarbonate/ABS

**Finish:** Gray/Black/Chrome

**VMRS Code:** 034-004-036

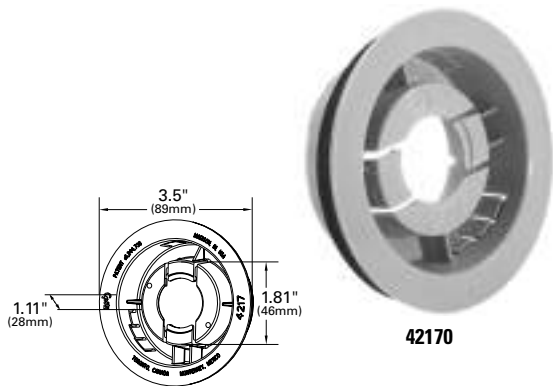

**42170**

## SNAP-IN MOUNTING FLANGE FOR 2 1/2" ROUND LAMPS

Flange is held into place by snap tabs for a quicker, easier installation • Snap tabs on the flange lock the flange into place, keeping it from backing out of the hole • Foam gasket allows for mounting in materials from 1/8" to 1/4" thick • Requires 2 25/32" mounting hole

### MOUNTING FLANGE:

**42170** Gray

### SECURITY RING:

**43823** Stainless Steel

**Material:** Polycarbonate/Stainless Steel

**Finish:** Gray/Chrome

**VMRS Code:** 034-004-036

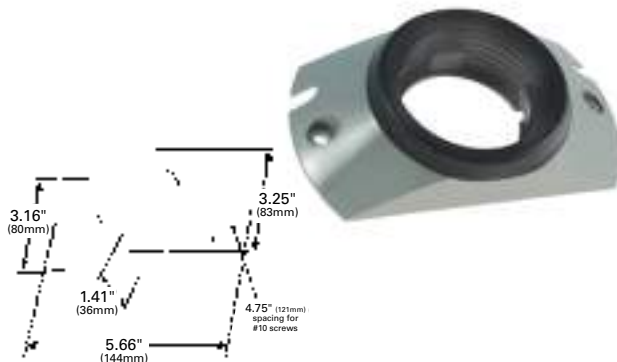

## SURFACE MOUNTING BRACKET WITH GROMMET FOR 2 1/2" ROUND LAMPS

• Includes grommet 91400 • 4 3/4" mounting screw hole spacing

**93750** Gray

**Material:** Polycarbonate/PVC

**Finish:** Gray/Black

**VMRS Code:** 034-004-036

**TWIST-IN SURFACE MOUNT BRACKET FOR 2" AND 2 1/2" ROUND LAMPS**

4" mounting screw hole spacing

**43690** Gray

**Material:** Polycarbonate  
**Finish:** Gray  
**VMRS Code:** 034-004-036



**TWIST-IN SURFACE MOUNT BRACKET FOR 2" AND 2 1/2" ROUND LAMPS**

3" mounting screw hole spacing • Supports the use of PC-rated lamps for greater visibility

**42180** Gray

**Material:** Polycarbonate  
**Finish:** Gray  
**VMRS Code:** 034-004-036



**4 5/8" CORNER RADIUS SURFACE MOUNT BRACKET FOR 2" AND 2 1/2" ROUND LAMPS**

Fits 4 5/8" corner radius • Use with PC-rated lights

**43760** Gray

**Material:** Polycarbonate  
**Finish:** Gray  
**VMRS Code:** 034-004-036

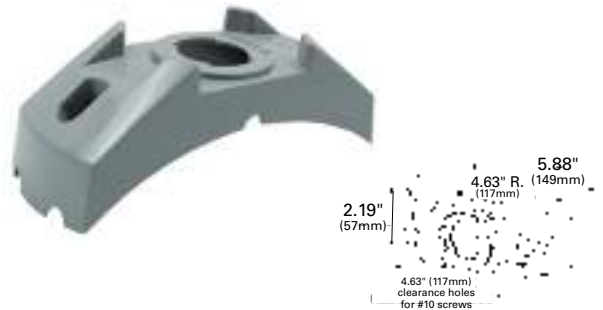

**90° ANGLE MOUNTING BRACKET FOR 2" AND 2 1/2" ROUND LAMPS**

Baked black enamel finish • Grommet required for mounting • 2 1/4" mounting screw hole spacing

**FOR 2 1/2" LAMPS:**

**43512** Accommodates 94010, 91400, 92070 Grommets (2 25/32" Hole)

**43522** Accommodates 94000, 91410 Grommets (3" Hole)

**FOR 2" LAMPS:**

**43532** Accommodates 94100, 92120, and 92150 Grommets (2 5/16" Hole)

**Material:** Steel  
**Finish:** Black Enamel  
**VMRS Code:** 034-004-036

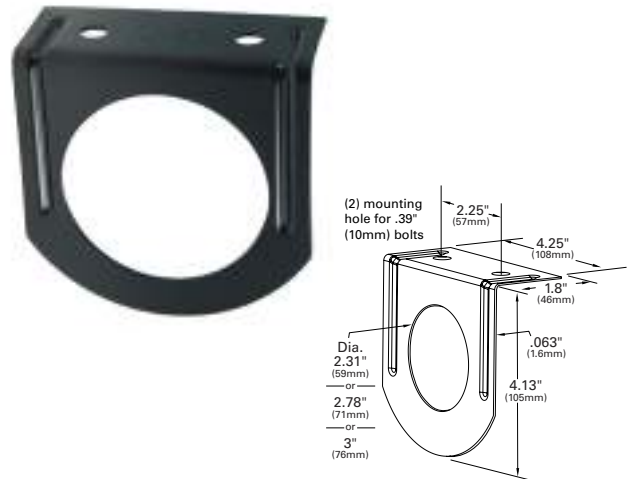

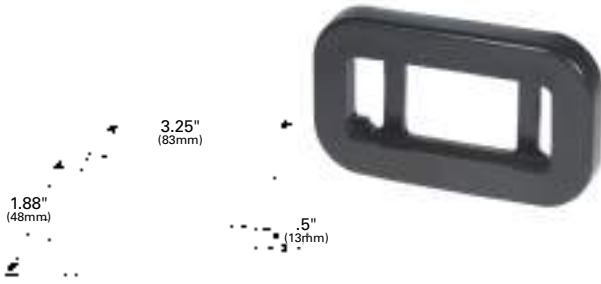

**GROMMET FOR SMALL RECTANGULAR LAMPS**

Requires 1 1/2" x 2 7/8" hole (with 3/8" radius corners) • Fits panel thickness up to .2"

**91380** Black

**Material:** PVC

**Finish:** Black

**VMRS Code:** 034-002-002

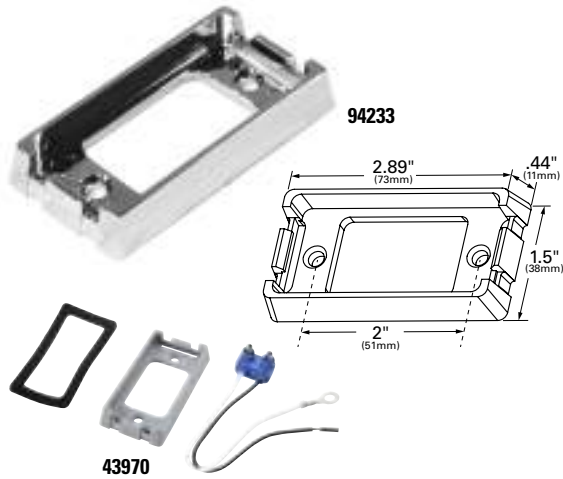

**BRACKET FOR SMALL RECTANGULAR LAMPS**

2" mounting screw hole spacing • Kits include pigtail and mounting pad

**94233** Chrome-Plated

**KITS:**

**43970** Gray (+ 67050 pigtail)

**43980** Chrome-Plated (+ 67050 pigtail)

**Material:** Polycarbonate/ABS

**Finish:** Chrome/Gray

**VMRS Code:** 034-002-002 - 94233  
034-004-036 - 43970, 43980

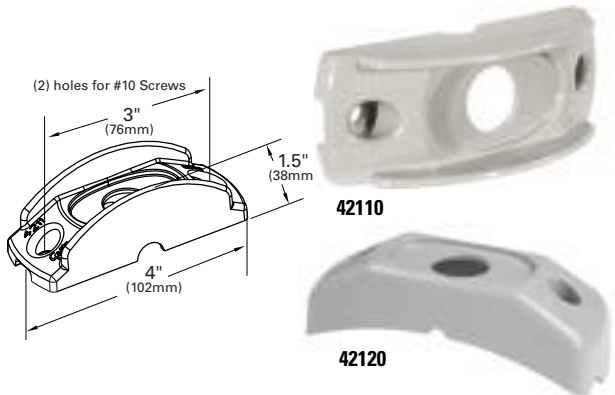

**SURFACE MOUNT BRACKET FOR MICRONOVA® OR MICRONOVA DOT**

Armored design to protect the lamp from damage • 3" mounting screw hole spacing (2 3/4" spacing for radius bracket)

**42110** Gray

**42120** Gray, Corner Radius Bracket

**Material:** Polycarbonate

**Finish:** Gray

**VMRS Code:** 034-004-036 - 42110

**4 3/4" CORNER RADIUS BRACKET**

For use with PC-rated lights • 4 13/16" mounting screw hole spacing • works with Turtleback® II style lamps

**43050** Gray

**Material:** Polycarbonate

**Finish:** Gray

**VMRS Code:** 034-004-036

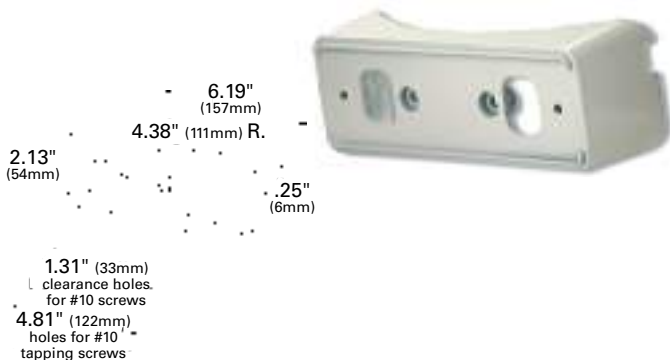

### HEADER-MOUNT BRACKET FOR SMALL RECTANGULAR LAMPS

Mountable at 45° angle for PC applications • Narrow rail applications  
 • 3 39/64" mounting screw hole spacing • Kit includes single-seal pigtail

**KITS:**

**43380** White (42141 + 67050)

**Material:** Polycarbonate  
**Finish:** White  
**VMRS Code:** 034-004-036

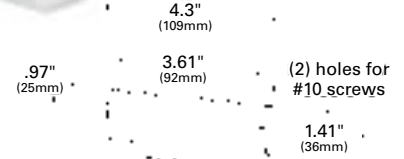

### GROMMET FOR SMALL RECTANGULAR LAMPS

Requires 2 1/2" x 3 1/2" hole (with 17/32" corners) • Fits panel thickness up to 3/16"

**93400** White  
**93402** Black

**Material:** PVC  
**Finish:** Black/White  
**VMRS Code:** 034-004-058



**93402**

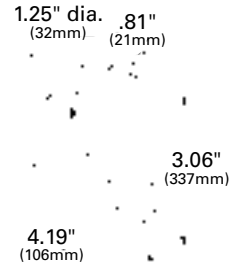

### MICRONOVA® LAMP BEZEL

Corrosion resistant, chrome-plated • Snap-fit mounting

**93803** Chrome-plated

**Material:** ABS  
**Finish:** Chrome  
**VMRS Code:** 034-004-036

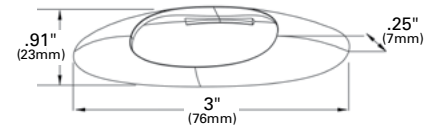

### LICENSE LAMP BRACKET FOR SMALL RECTANGULAR LAMPS

Anti-glare shield eliminates stray light from distracting following motorists  
 • 3" mounting screw hole spacing • Snap-in lamp installation

**42162** Black

**Material:** Polycarbonate  
**Finish:** Black  
**VMRS Code:** 034-004-036

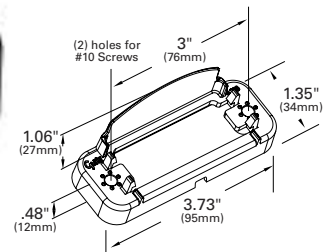

### LICENSE LAMP MOUNTING BRACKET

Features snap-in lamp installation • Fits license lamp 60671, 60261, 60601  
 Anti-glare shield eliminates stray light from distracting following motorists  
 • 2" mounting screw hole spacing

**43960** Gray  
**43962** Black

**Material:** Polycarbonate  
**Finish:** Gray/Black  
**VMRS Code:** 034-004-036



**43960**

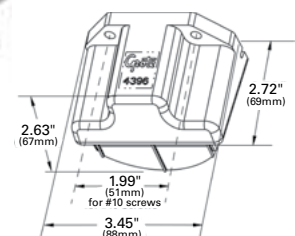



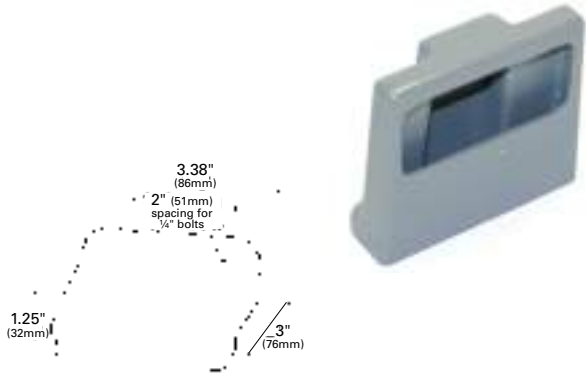

### LICENSE LAMP MOUNTING BRACKET

Fits license lamp 60261 • 2" mounting screw hole spacing • Thin design reduces mounting space requirements

**43830** Gray

**Material:** Polycarbonate

**Finish:** Gray

**Grommet:** 92520

**VMRS Code:** 034-004-036

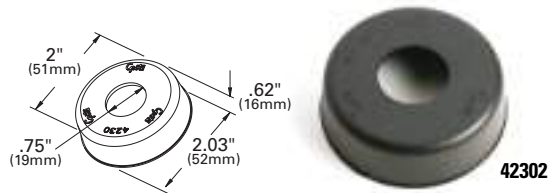

**42302**



**42312**

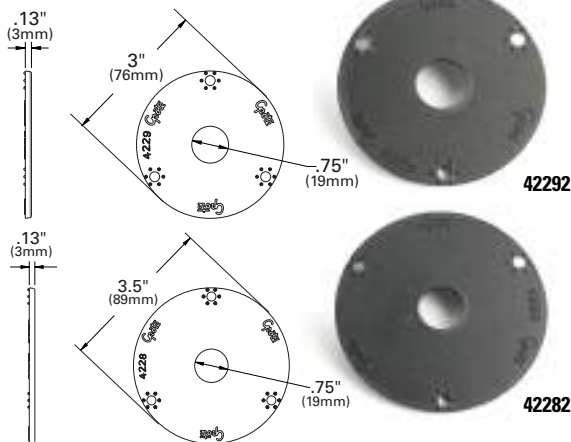

**42292**

**42282**

### MICRONOVA® DOT ROUND ADAPTER BRACKETS

Assembles directly into 2" and 2.5" PVC grommets • Replaces any incandescent or LED 2" or 2.5" round clearance/marker • Flanges torque to a maximum of 25 in-lbs and mount with three #10 pan or round head screws into existing hole patterns of 2" and 2.5" flanges

**42302** 2" Round Grommet Adapter

**42312** 2.5" Round Grommet Adapter

**42292** 3" Round Flange Adapter

**42282** 3.5" Round Flange Adapter

**VMRS Code:** 034-004-036



### MICRONOVA® SURFACE MOUNT BRACKET

4 13/16" mounting hole separation provides easy retrofit  
• Great for narrow surface mounting applications

**42070** Gray

**Material:** Polycarbonate

**Finish:** Gray

**VMRS Code:** 034-004-037

### MICRONOVA® DOT ADAPTER BRACKET

Allows the MicroNova® DOT to mount directly to the vehicle using this bracket or snap-fit into compatible 4378-series mounting brackets  
 • 2 1/2" - 3" mounting screw hole spacing

**94350** Gray

**Material:** Polycarbonate  
**Finish:** Gray  
**VMRS Code:** 034-004-036

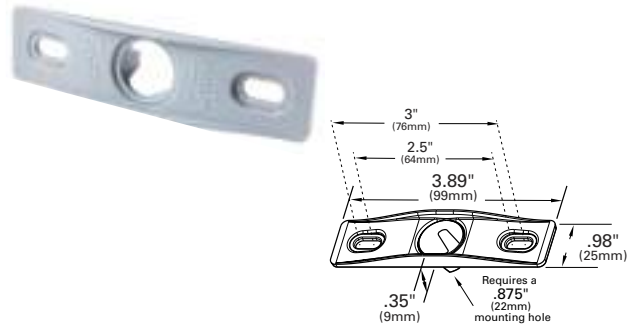

### MOUNTING BRACKET FOR LARGE RECTANGULAR LAMPS

• 3" mounting screw hole spacing • Kits include unique connector design with plug-in pigtail

**43780** Gray Bracket

**43783** Chrome-Plated Bracket, ABS

**KITS:**

**43390** Gray (43780 + 66981)

**43790** Gray (43780 + 66980)

**Material:** Polycarbonate/ABS  
**Finish:** Gray/Chrome  
**VMRS Code:** 034-004-036

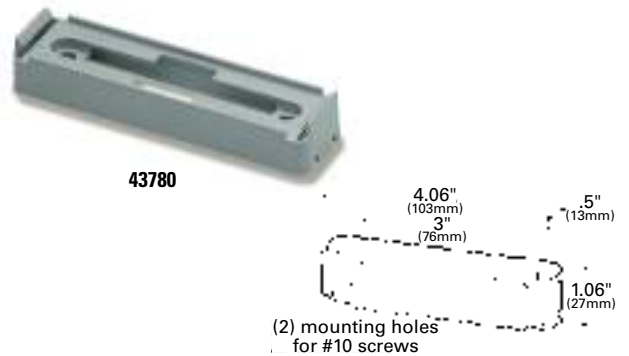

### LOW-PROFILE MOUNTING BRACKET

Integrated plug connection • Legal mount for combination clearance/ marker lamp when mounted on a 45° angle (PC) • 3" mounting screw hole spacing

**43850** Gray

**Material:** Polycarbonate  
**Finish:** Gray  
**VMRS Code:** 034-004-036

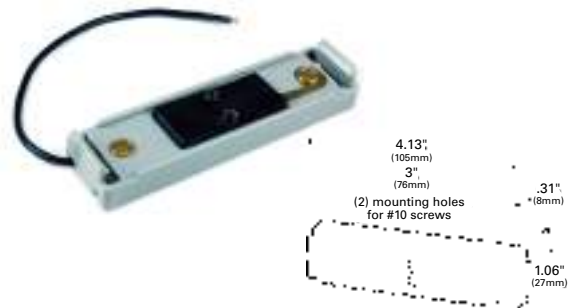

### M1 SERIES LAMP BEZEL

For use with M1 style cab markers

**93453** Chrome

**Material:** ABS  
**Finish:** Chrome  
**VMRS Code:** 034-004-036

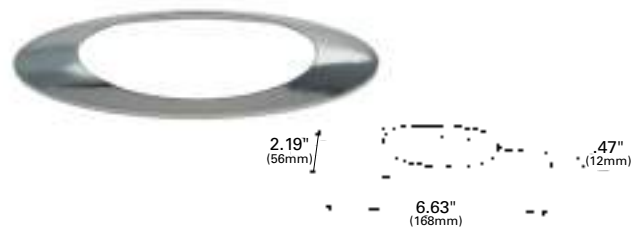

### SMALL CAB MARKER BEZEL

Can be installed while lamps are mounted

**92583** Bezel

**Material:** ABS  
**Finish:** Chrome  
**VMRS Code:** 034-004-036

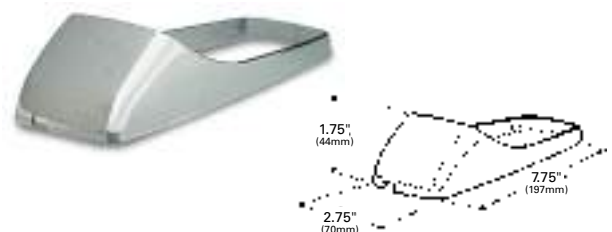

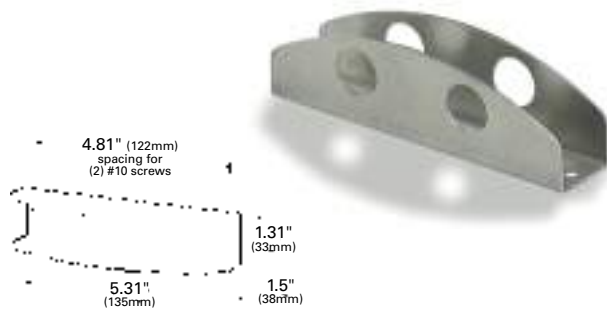
**THIN-LINE LED LAMP GUARD**

Cutaway to accept plug-in pigtail • For use with 4690, 4692, and 4693 series lamps

**43074** Aluminum

**Material:** Aluminum

**Finish:** Aluminum

**VMRS Code:** 034-004-130

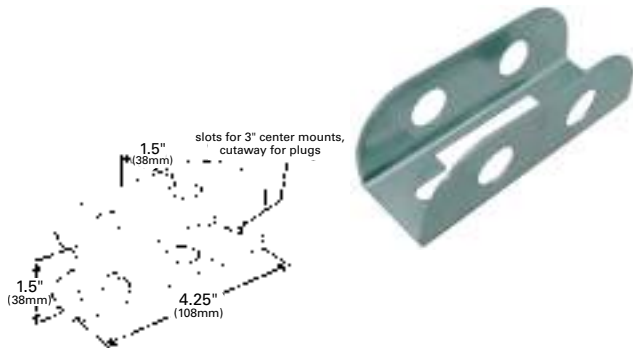
**LAMP GUARD FOR SMALL RECTANGULAR LAMPS**

Cutaway to accept plug-in pigtail

**43120** Aluminum

**Material:** Aluminum

**Finish:** Aluminum

**VMRS Code:** 034-004-036

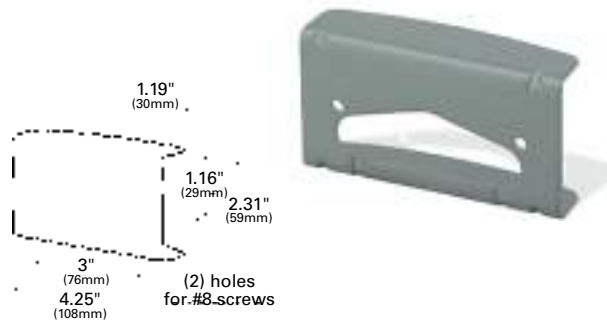
**STEEL LAMP GUARD**

For use with 2" x 4" oval and square corner surface mount clearance/marker lamps • 3" mounting screw hole spacing

**43144** Steel

**Material:** Steel

**Finish:** Silver

**VMRS Code:** 034-004-130

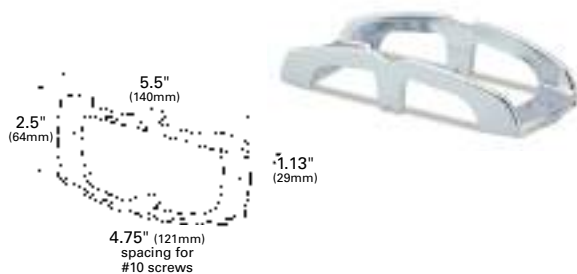
**CHROME BUTTRESS-STYLE LAMP GUARD**

For use with 2" x 4" oval and square corner surface mounted lamps • 4 3/4" mounting screw hole spacing

**43673** Chrome-Plated

**Material:** ABS

**Finish:** Chrome

**VMRS Code:** 034-004-130

**RECESSED MOUNTING GROMMET FOR 4" ROUND LAMPS**

Requires 4 1/2" mounting hole • Fits panel thickness up to 1/4"

**91740** Grommet

**Material:** PVC

**Finish:** Black

**VMRS Code:** 034-002-002 - 91740

**CLOSED BACK RECESSED MOUNTING GROMMET FOR 4" ROUND LAMPS**

For open installations where splash plate is not used • Requires a 4 1/2" mounting hole • Fits panel thickness up to 1/4"

**91950** Grommet

**Material:** PVC  
**Finish:** Black  
**VMRS Code:** 034-002-002

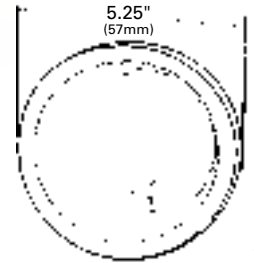

**STAINLESS STEEL SNAP-IN THEFT-RESISTANT MOUNTING FLANGE FOR 4" ROUND LED LAMPS**

Foam gasket allows for mounting in materials from 1/8" to 1/4" thick • Requires 4 1/2" mounting hole • No drilling necessary to install

**93683** Stainless Steel

**Material:** Stainless Steel  
**Finish:** Stainless Steel  
**VMRS Code:** 034-002-006

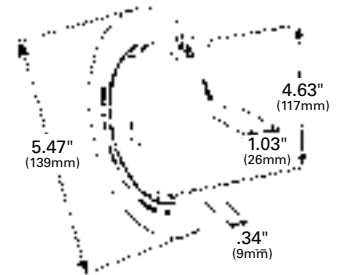

**SNAP-IN THEFT-RESISTANT MOUNTING FLANGE FOR 4" ROUND LED LAMPS**

Fits panel thickness 1/8" to 1/4" • Requires 4 1/2" mounting hole

**93552** Black  
**93553** Chrome-Plated

**Material:** ABS  
**Finish:** Black/Chrome  
**VMRS Code:** 034-002-006

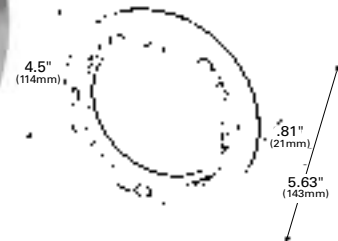

**THEFT-RESISTANT MOUNTING FLANGE FOR 4" ROUND LAMPS**

For use with 4" round LED and incandescent lamps • Mounting hole size 4 1/2" diameter

**92510** White, Polycarbonate  
**92512** Black, Polycarbonate  
**92513** Chrome-Plated, ABS  
**92511** Gray, Polycarbonate  
**43253** Stainless Steel

**SECURITY RING**

**43343** Stainless Steel Security Ring (must be used with flange)

**Material:** Polycarbonate; Stainless Steel; ABS  
**Finish:** White; Gray; Black; Chrome; Stainless Steel  
**VMRS Code:** 034-002-006

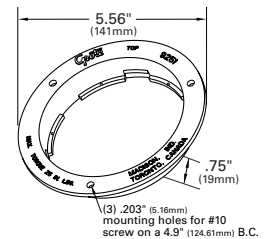

(3) mounting holes for #10 screw on 4.91" B.C. (125mm)



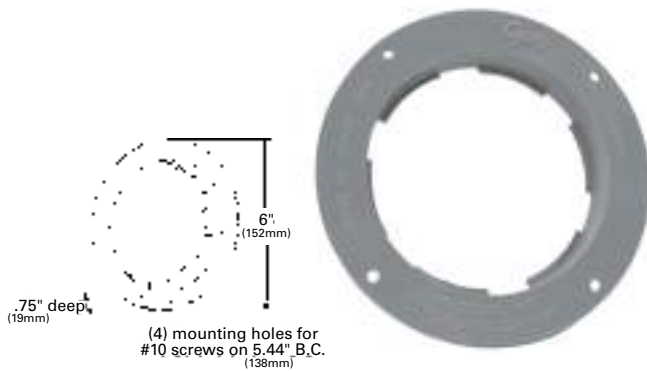

### THEFT-RESISTANT BETTS LIGHTING MOUNTING ADAPTER

Allows users to retrofit their Betts brand lighting to Grote® mounting dimensions • Retrofits to Grote® 4" round sealed lamps and LEDs

- Requires 4 1/2" diameter mounting hole

**93190** Gray

**Material:** Polycarbonate

**Finish:** Gray

**VMRS Code:** 034-002-006

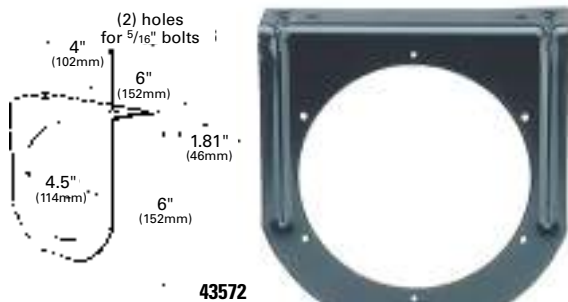

### ANGLED MOUNTING BRACKET FOR 4" ROUND LAMPS

Accepts lamp equipped with a grommet or flange • 4" mounting screw hole spacing

**43572** Black, 90° angle bracket

**Material:** Steel

**Finish:** Black Powder-Coated

**Grommet:** 91740

**VMRS Code:** 034-002-006

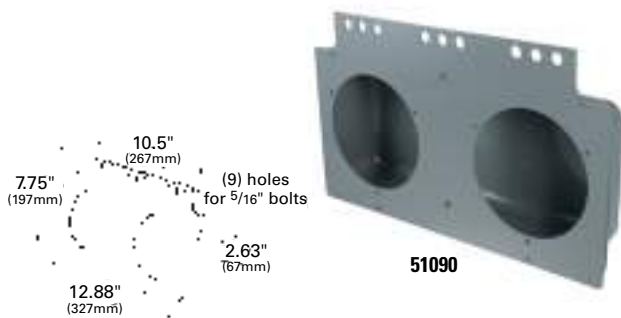

### MOUNTING MODULE FOR 4" ROUND LAMPS

Closed back, rear lamp module for lamps requiring 4 1/2" mounting hole opening • Accepts lamps equipped with a grommet or flange

**43655** Yellow Zinc

**51090** Gray

**Material:** Steel

**Finish:** Yellow Zinc/Gray Powder-Coated

**VMRS Code:** 034-002-006 - 43655

078-002-004 - 51090

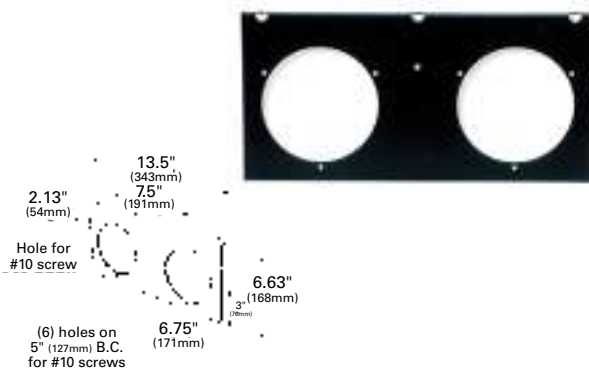

### 2-LAMP MOUNTING MODULE FOR 4" ROUND LAMPS

Two 4 1/2" mounting holes to hold standard recessed lamps or grommet-mounted 4" round lamps • Accepts lamps equipped with a grommet or flange • #10 mounting screw hole in center accepts 2 1/2" round reflector

**43642** Black, Powder-Coated

**Material:** Steel

**Finish:** Black

**VMRS Code:** 034-002-006



**MOUNTING MODULE FOR 4" ROUND LAMPS**

Black enamel-coated steel construction • Use with 4" LED strobes or any 4" round lamp • Accepts lamp equipped with a grommet or flange • Weld to your chassis or apparatus

**43732** Black

**Material:** Steel  
**Finish:** Black  
**VMRS Code:** 034-001-051

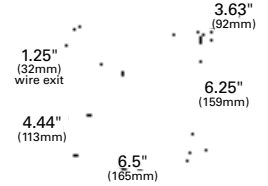

**O-RING**

**94110** O-Ring for use with 46782 and 46783 lamps

**VMRS Code:** 031-004-124

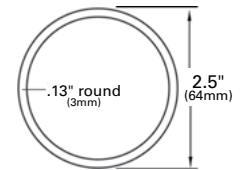

**SNAP RING**

**99593** Use with 50222 and 50352  
**99595** Use with 50232

**Material:** Stainless Steel  
**Finish:** Stainless Steel  
**VMRS Code:** 034-002-005

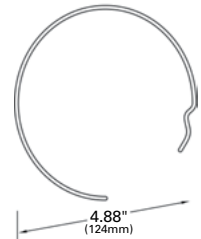

**RECESSED MOUNTING GROMMET FOR 6" OVAL LAMPS**

Fits 2 1/2" x 6 3/4" oval mounting hole • Fits panel thickness up to 1/4"

**92420** Open Grommet  
**92720** Closed Back Grommet

**Material:** PVC  
**Finish:** Black  
**VMRS Code:** 034-002-002



**92420**

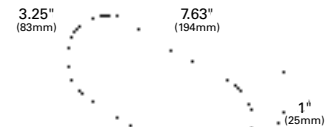

**SURFACE MOUNT SNAP-IN BRACKET FOR 6" OVAL LAMPS**

Allows for quick and easy surface mount application • Designed to work with 5413-, 5414-, 5416-, 5417-product lines only. • 6" mounting screw hole spacing

**42152** Black, Polycarbonate  
**42153** Chrome, ABS

**Material:** Polycarbonate/ABS  
**Finish:** Black/Chrome  
**VMRS Code:** 034-004-036



**42153**

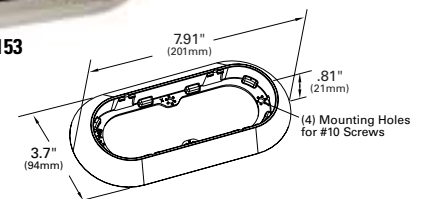

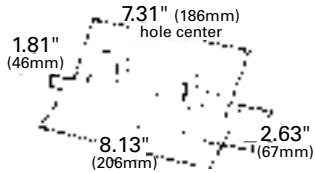

## SURFACE MOUNT BRACKET FOR 6" OVAL LAMPS

Can be used with any Grote® 6" oval LED or incandescent lamp

- Ideal for adding LED strobe lamps to a vehicle
- 7 5/16" mounting screw hole spacing

**43172** Black

**Material:** Polycarbonate

**Finish:** Black

**VMRS Code:** 034-002-006

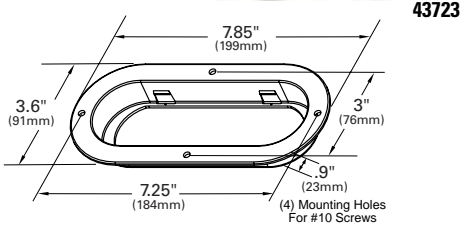

## THEFT-RESISTANT MOUNTING FLANGE FOR 6" OVAL LAMPS

For use with most LED and incandescent lamps • Security ring fits over oval theft-resistant mounting flanges • 7 1/4" x 3" mounting screw hole spacing

**42103** Stainless Steel, Security Ring

**43220** Gray, Polycarbonate

**43222** Black, Polycarbonate

**43223** Chrome-Plated, ABS

**43723** Stainless Steel

**Material:** Polycarbonate/Stainless Steel/ABS

**Finish:** Gray/Black/Stainless Steel/Chrome

**VMRS Code:** 034-002-006

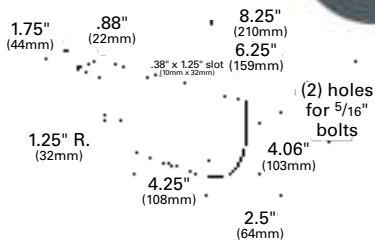

## ANGLED MOUNTING BRACKET FOR 6" OVAL LAMPS

Accepts lamp equipped with a grommet or flange • 6 1/4" mounting screw hole spacing

**43362** Black, 90° angle bracket

**Material:** Steel

**Finish:** Black

**Grommet:** 92420

**VMRS Code:** 034-002-006

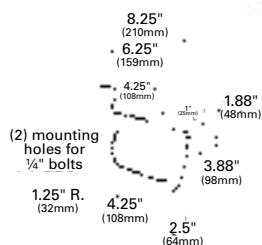

## "Z" MOUNTING BRACKET FOR 6" OVAL LAMPS

Heavy-gauge steel, baked black enamel finish • Accepts lamp equipped with a grommet or flange • 6 1/4" mounting screw hole spacing

**43952** Black

**Material:** Steel

**Finish:** Black

**Grommet:** 92420

**VMRS Code:** 034-002-006

### MOUNTING BRACKET FOR 6" OVAL LAMPS AND STROBES

Accepts lamp equipped with a grommet or flange • 8 1/4" mounting screw hole spacing • Weld to your chassis or apparatus

**43100** Black

**Material:** Steel  
**Finish:** Black  
**Grommet:** 92420  
**VMRS Code:** 034-001-051



### MOUNTING BRACKET FOR 7" ROUND LAMPS

Heavy-gauge steel • For use with 7800, 7830 and 7831 series lamps

**43282** Black, Powder-Coated

**Material:** Steel  
**Finish:** Black  
**VMRS Code:** 034-003-080



### MOUNTING BRACKET FOR UTILITY LAMPS

Detachable angle mounting bracket for utility work lamps with standard 3/8" mounting

**43292** Black, Powder-Coated

**Material:** Steel  
**Finish:** Black  
**VMRS Code:** 034-003-080

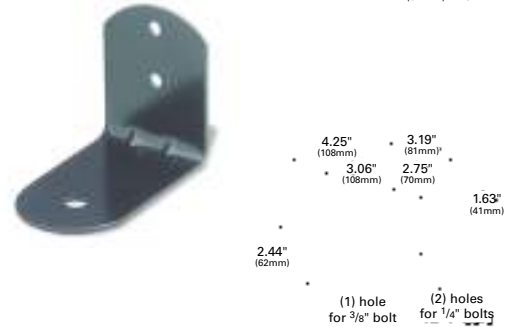

### RECESSED MOUNTING GROMMET FOR RECTANGULAR LAMPS

Requires 5 7/16" x 3 9/16" mounting hole with 1" radius corners • Fits panel thicknesses up to 5/16"

**94180** Mounting Grommet

**Material:** PVC  
**Finish:** Black  
**VMRS Code:** 034-002-002



### 90° ANGLE BRACKET FOR 7" ROUND LAMPS

Provides multiple mounting options for flush mount 7" round lamps

**93982** Black, Powder-Coated

**Material:** Steel  
**Finish:** Black  
**VMRS Code:** 034-001-022

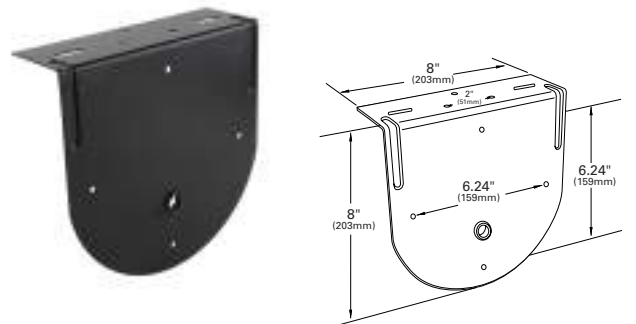

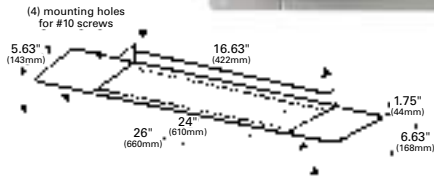

**RECESSED FLUORESCENT LAMP PAN**

Provides a rigid mounting surface for fluorescent lamps • Fits Grote's fluorescent lamp 61511 • Keeps insulation away from lamp

**43540** Recessed Pan

**Material:** Aluminum  
**Finish:** Polished  
**VMRS Code:** 034-004-036

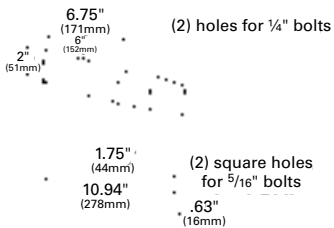

**SLOW-MOVING VEHICLE EMBLEM BRACKETRY**

Easy installation • Use with slow-moving vehicle emblem 71152 (emblem not included)

**EMBLEM BRACKET:**

**43325** Steel

**Material:** Steel  
**Finish:** Galvanized  
**VMRS Code:** 034-001-051

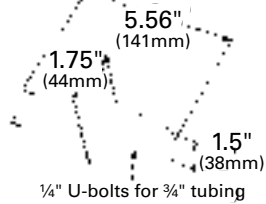

**STROBE AND BEACON MOUNTING ADAPTER FOR MIRROR BRACKET ASSEMBLY**

Allows for mounting of strobe and beacon warning lamps to mirror bracket assembly

**PIPE MOUNT:**

**93600** Aluminum/Steel Bracket w/ 1" Built-in Mount

**Material:** Aluminum/Steel  
**Finish:** Gray  
**VMRS Code:** 034-001-051

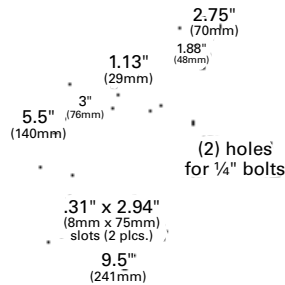

**UNIVERSAL OFFSET LICENSE PLATE BRACKET**

For use with most standard two-stud box-style lamps and license plates

**43262-5** Black **RETAIL**

**Material:** Polypropylene  
**Finish:** Black  
**VMRS Code:** 034-004-036

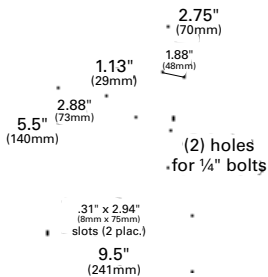

**UNIVERSAL STEEL OFFSET LICENSE PLATE BRACKET**

For use with most standard two-stud box-style lamps and license plates

**43022** Black, Powder-Coated  
**43022-5** Black, Powder-Coated **RETAIL**

**Material:** Steel  
**Finish:** Black  
**VMRS Code:** 034-004-036

### UNIVERSAL STEEL LICENSE PLATE BRACKET

For use with most standard two-stud box-style lamps and license plates

- 43272 Black, Powder-Coated
- 43272-5 Black, Powder-Coated **RETAIL**

**Material:** Steel  
**Finish:** Black  
**VMRS Code:** 034-004-036



### UNIVERSAL STEEL LICENSE PLATE BRACKET

For use with most standard two- or three-stud box-style lamps and license plates

- 43842 Black, Powder-Coated

**Material:** Steel  
**Finish:** Black  
**VMRS Code:** 034-004-036

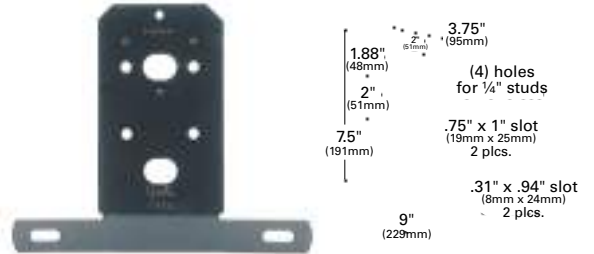

### ADJUSTABLE BRACKET FOR TRILLIANT® LAMPS

Adjustable and lockable bracket for the Trilliant® LED Whitelight lamps

- Provides more aiming control and more reliability than the standard bracket
- Cantilever locking mechanism stays in place in even the harshest environments

- 43652 Bracket, Black

**Material:** Zinc  
**Finish:** Black  
**VMRS Code:** 034-006-034

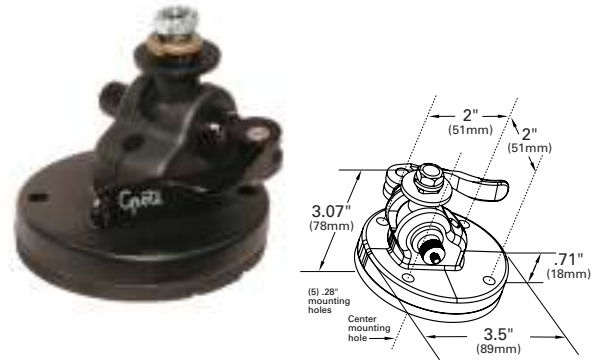

### WORK LIGHT MOUNTING BRACKET

- Designed to work with most Trilliant® and Brite Zone® work lights
- Allows work lamps to pivot without damage to vehicle
- Robust construction to withstand multiple hours of vibration
- Mount direct to vehicle with M6 fasteners

- 94450 Steel Mounting Bracket

**Material:** 16 GA Steel  
**VMRS Code:** 034-006-034

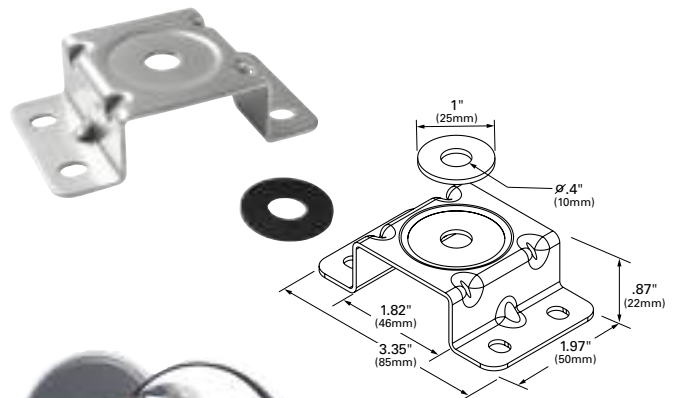

### REPLACEMENT MAGNETIC MOUNT

Can be used as a magnetic mount on Par 36 rubber tractor and utility lamps

- Has adhesive magnet pad to prevent scratching of vehicle
- 80 lb. pull magnet

- 43300 Magnetic Mount

**Material:** Steel  
**Finish:** Chrome  
**VMRS Code:** 034-001-051

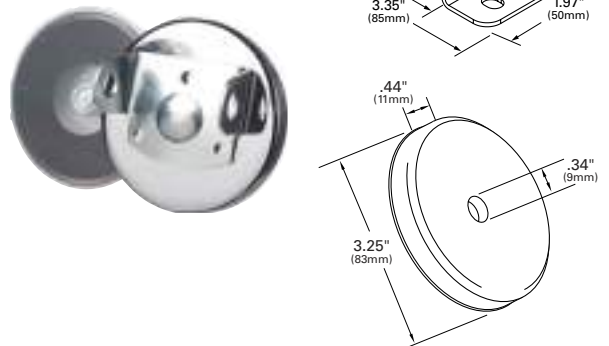



(2) slots for #8 screws  
-19" x .25"  
(5mm x 6mm)

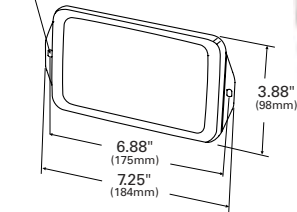

## FLUSH-MOUNT WORK LAMP BRACKET

Add-on bracket to convert the Trilliant® Mini LED Work Lamp into a flush-mount lamp

**94690** Stainless Steel

**Material:** Stainless Steel

**Finish:** Stainless Steel

**VMRS Code:** 034-002-002

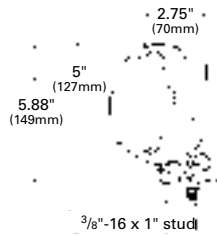

## PAR 36 RUBBER TRACTOR HOUSING

Shock-absorbing, weather-proof body • Swivel mount

**64930** Black

**Material:** Rubber

**Finish:** Black

**VMRS Code:** 034-001-015



## AGRICULTURE LIGHT ADAPTER BRACKET KIT

Fits Surface-mount LED amber warning & red stop/tail/turn lamps

• Surface-mount lamps can be connected as a dual-lamp with use of the adapter bracket

**98130** Agriculture Light Adapter Bracket Kit

**VMRS Code:** 034-004-044

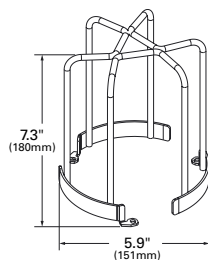

## WARNING & HAZARD 6" BRANCH GUARD

Fits Products: 78051, 78053, 78055, 78061, 78063, 78065, 78081, 78085, 78050, 78052, 78054, 78080

**98460** 6" Branch Guard

**Material:** Steel w/ Black Powder Coat

**VMRS Code:** 034-004-153

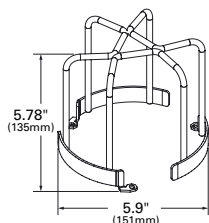

## WARNING & HAZARD 4" BRANCH GUARD

Fits Products: 78031, 78033, 78035, 78071, 78075, 78851, 78070, 78030, 78034, 78851, 78853, 78855

**98470** 4" Branch Guard

**VMRS Code:** 034-004-153

**WARNING & HAZARD 6" OVAL BEZEL**

Fits Products: 78190, 78191, 78193, 78194, 78195

- 98410 6" Oval Black Bezel
- 98480 6" Oval Chrome Bezel

Material: ABS  
 VMRS Code: 034-001-051



98480 98410

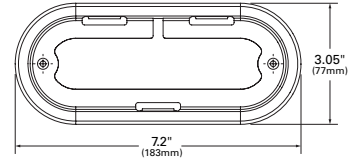

**WARNING & HAZARD DIRECTIONAL  
 WARNING BRACKETS AND BEZELS**

Fits Products: 78140, 78141, 78142, 78143, 78144, 78145, 78146, 78460, 79080, 79100, 79110, 79120

**BRACKET**

- 98350 License Bracket, Aluminum
- 98360 L Bracket, Steel

**BEZEL**

- 98390 Directional Chrome Bezel
- 98400 Directional White Bezel

Material: 98390 - ABS, 98400 - Polycarbonate  
 VMRS Code: 034-001-051



98350 98360

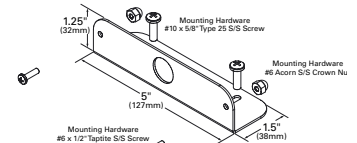
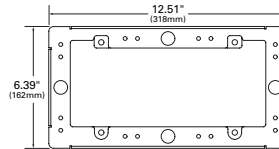

98400 98390

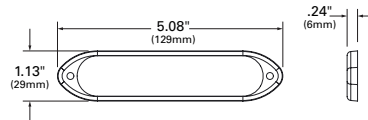

# 15

## REFLECTORS

*RÉFLECTEURS*

*REFLECTANTES*

## CONSPICUITY TAPE

Exceeds DOT requirements • Durable, impact and solvent resistant • Easy installation • Reflects light even in daytime • Bright prismatic appearance

### ALTERNATING 7" SILVER/11" RED:

- 40650** 2" x 150' Roll, 10-year Warranty
- 40650-5** 2" x 18" (5) Strips RETAIL
- 41160** 2" x 150' Roll, 5-year Warranty
- 41080** 1.5" x 150' Roll, 10-year Warranty

### ALTERNATING 6" SILVER/6" RED:

- 41050** 2" x 150' Roll, 10-year Warranty

### SILVER:

- 40641** 2" x 150' Roll, 10-year Warranty
- 40641-5** 2" x 12" (4) Strips, Poly Bag, 10-year Warranty RETAIL

### SCHOOL BUS APPLICATION:

- 41133** Yellow, 2" x 150' Roll, 10-year Warranty

### WHITE:

- 40701** 2" x 150' Roll, 10-year Warranty

**Regulations / Standards:** FMVSS 108 / DOT-C2 (40641, 40650, 40650-5, 41050, 41160)

**VMRS Code:** 053-004-005



## REFLECTIVE STRIPS

Sealed optics • Adhesive-backed or screw-on mounting versions • 7 1/4" mounting screw hole spacing

### 12" STRIPS:

- 41122** Red
- 41121** Silver

**Material:** ABS/Acrylic

**Regulations / Standards:** FMVSS 108 / DOT-C

**VMRS Code:** 053-004-005

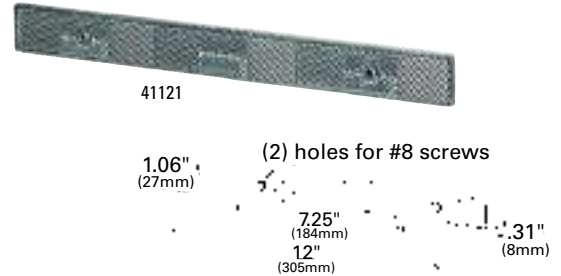

## STICK-ON TAPE REFLECTORS

Adheres permanently to flat or curved surfaces • Exceeds DOT and SAE "A" reflex requirements • Durable, impact resistant

### 1 11/16" X 4 1/4" RECTANGULAR REFLECTOR:

- 41152** Red, 5-year Warranty
- 41153** Yellow, 5-year Warranty

### 2 15/16" ROUND REFLECTOR:

- 41142** Red, 5-year Warranty
- 41143** Yellow, 5-year Warranty

**Regulations / Standards:** FMVSS 108 / SAE A

**VMRS Code:** 053-004-036 - 41152, 41142  
053-004-035 - 41153, 41143

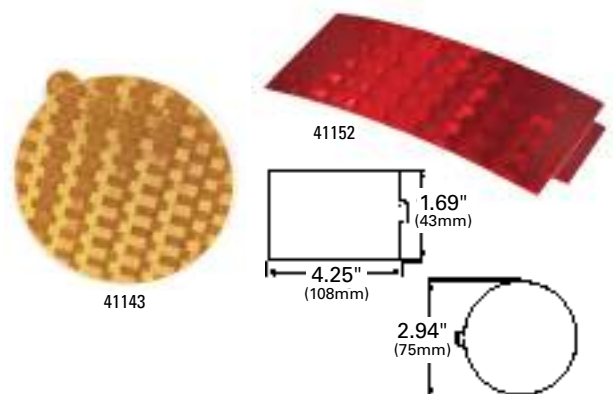

**STICK-ON RECTANGULAR REFLECTORS**

Adhesive backing protects prisms against dirt • Fits narrow rails and tight spaces • Firm-stick backing for instant bond and lasting adhesion

**40302** Red  
**40303** Yellow

**Material:** Acrylic

**Regulations / Standards:** FMVSS 108 / SAE A

**VMRS Code:** 053-004-036 - 40302  
053-004-035 - 40303

**MINI STICK-ON RECTANGULAR REFLECTORS**

Fits narrow rails and tight spaces • Mountable with two #8 screws (optional) • 3 15/16" mounting screw hole spacing • Firm-stick backing for instant bond and lasting adhesion

**STICK-ON/SCREW MOUNTABLE:**

**40132** Red  
**40132-5** Red, Pair Pack **RETAIL**  
**40133** Yellow  
**40133-5** Yellow, Pair Pack **RETAIL**

**Material:** Acrylic

**Regulations / Standards:** FMVSS 108 / SAE A

**VMRS Code:** 053-004-036 - 40132, 40132-5  
053-004-035 - 40133, 40133-5

**OVAL REFLECTOR**

Firm-stick backing for instant bond and lasting adhesion • Mountable with two #8 screws (optional) • 3 15/16" mounting screw hole spacing

**SCREW MOUNTABLE:**

**41042** Red  
**41043** Yellow

**STICK-ON/SCREW MOUNTABLE:**

**41032** Red  
**41033** Yellow

**Material:** Acrylic

**Regulations / Standards:** FMVSS 108 / SAE A

**VMRS Code:** 053-004-036 - 41042, 41032  
053-004-035 - 41043, 41033

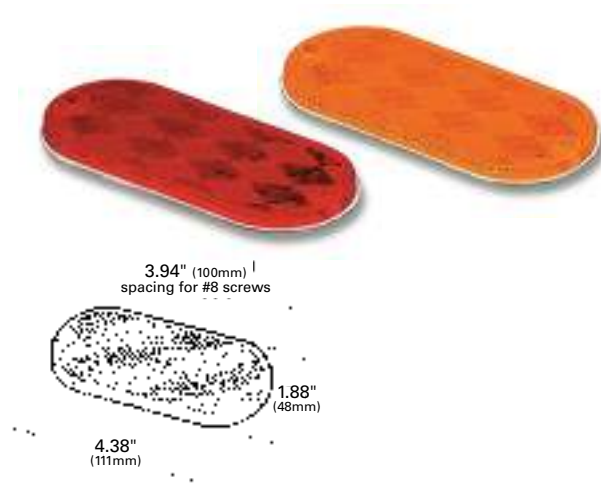
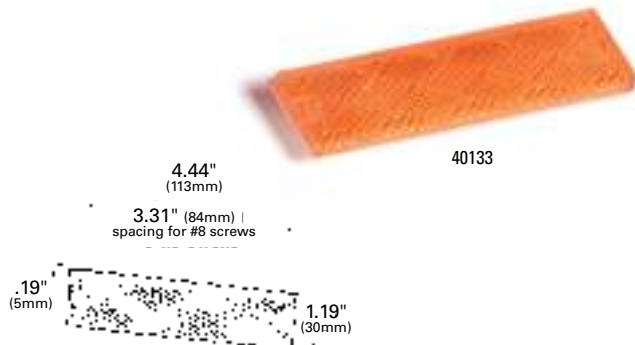
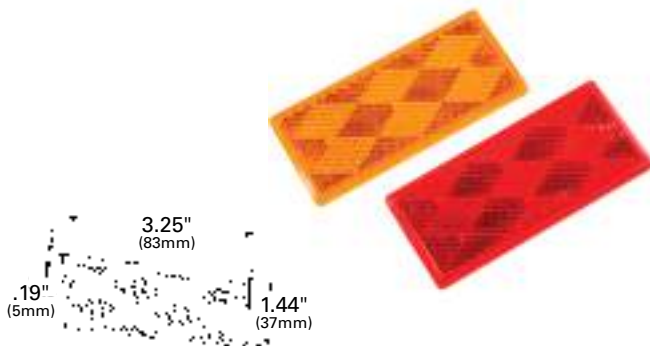



### ROUND STICK-ON REFLECTOR

Adhesive backing protects prisms against dirt • Firm-stick backing for instant bond and lasting adhesion

#### 3" REFLECTOR:

|                |        |               |
|----------------|--------|---------------|
| <b>40052</b>   | Red    |               |
| <b>40052-5</b> | Red    | <b>RETAIL</b> |
| <b>40053</b>   | Yellow |               |

#### 2" REFLECTOR:

|              |        |
|--------------|--------|
| <b>41002</b> | Red    |
| <b>41003</b> | Yellow |

**Material:** Acrylic

**Regulations / Standards:** FMVSS 108 / SAE A

**VMRS Code:** 053-004-036 - 40052, 40052-5, 41002  
053-004-035 - 40053, 41003

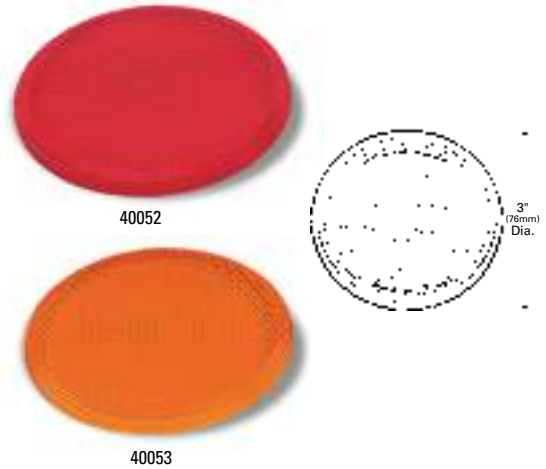

### SEALED 3" ROUND STICK-ON REFLECTOR

Hermetically sealed • Firm-stick backing for instant bond and lasting adhesion

|              |        |
|--------------|--------|
| <b>40062</b> | Red    |
| <b>40063</b> | Yellow |

**Material:** Acrylic

**Regulations / Standards:** FMVSS 108 / SAE A

**VMRS Code:** 053-004-036 - 40062  
053-004-035 - 40063

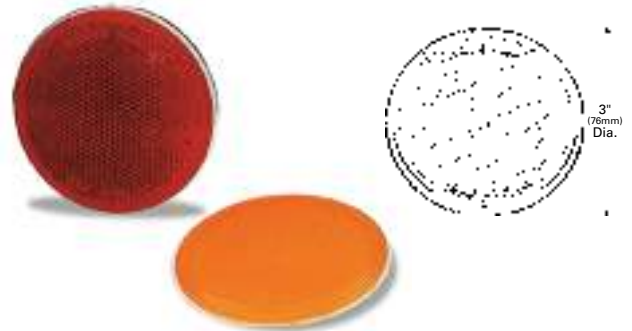

### 2½" ROUND STICK-ON REFLECTOR

Adhesive backing protects prisms against dirt • Firm-stick backing for instant bond and lasting adhesion

|                |                   |               |
|----------------|-------------------|---------------|
| <b>40072</b>   | Red               |               |
| <b>40072-5</b> | Red, Pair Pack    | <b>RETAIL</b> |
| <b>40073</b>   | Yellow            |               |
| <b>40073-5</b> | Yellow, Pair Pack | <b>RETAIL</b> |

**Material:** Acrylic

**Regulations / Standards:** FMVSS 108 / SAE A

**VMRS Code:** 053-004-036 - 40072, 40072-5  
053-004-035 - 40073, 40073-5

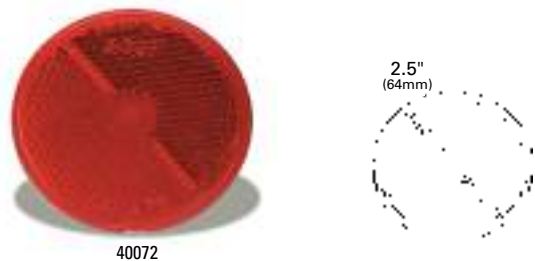

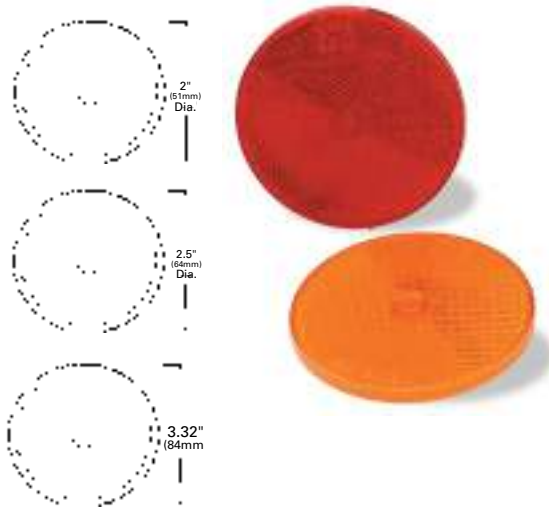

### SEALED CENTER-MOUNT REFLECTOR

Hermetically sealed • Simple installation with single #10 screw

**2" ROUND:**

- 41012 Red
- 41013 Yellow

**2½" ROUND:**

- 40092 Red
- 40093 Yellow

**3½" ROUND:**

- 40152 Red
- 40153 Yellow

**Material:** Acrylic  
**Regulations / Standards:** FMVSS 108 / SAE A  
**VMRS Code:** 053-004-036 - 41012, 40092, 40152  
 053-004-035 - 41043, 40093, 40153



### ALUMINUM TWO-HOLE MOUNTING REFLECTOR

Lens gasket cushions lens and protects prisms against dirt • Lightweight housing • Low profile • 3 15/16" mounting screw hole spacing

- 40232 Red
- 40232-5 Red **RETAIL**
- 40233 Yellow
- 40233-5 Yellow **RETAIL**

**Material:** Aluminum/Acrylic  
**Regulations / Standards:** FMVSS 108 / SAE A  
**VMRS Code:** 053-004-036 - 40232, 40232-5  
 053-004-035 - 40233, 40233-5



### STEEL TWO-HOLE MOUNTING REFLECTOR

Extra-deep lens recess for protection • Lens gasket cushions lens and protects prisms against dirt • Baked-steel finish • 3 15/16" mounting screw hole spacing

- 40192 Red, Silver Housing with Gasket
- 40193 Yellow, Silver Housing with Gasket

**Material:** Steel/Acrylic  
**Regulations / Standards:** FMVSS 108 / SAE A  
**VMRS Code:** 053-004-036 - 40192, 82562  
 053-004-035 - 40193

# ***SIGN-UP FOR GROTE'S ENHANCED G24/7 VISIT [ORDERS.GROTE.COM](http://ORDERS.GROTE.COM)***



Grote® Industries is pleased to announce the launch of the enhanced G24/7 system. This complimentary service is an innovative way to place orders, track order status and view all your Grote® product activity. From the convenience of your computer or mobile device, you can now access previously unavailable information that will help you more successfully manage your business and inventory.

## ***ORDERS.GROTE.COM***

### **NEW FEATURES**

- ***PAY ANY INVOICE ONLINE ANY TIME***
- ***EASY CREDIT CARD PROCESSING***
- ***NOW MOBILE FRIENDLY***
- ***REPRINT PACKING LISTS AND INVOICES***



#### ***UPLOAD FROM MICROSOFT® EXCEL***

Customers can also upload items from Microsoft® Excel to create orders.

#### ***REFER AND REORDER USING "MY LIST"***

The user can create a list of products for future reference or to reorder.

#### ***E-MAIL NOTIFICATION***

When a new order is created and when an order is shipped, unlimited recipients can receive an instant e-mail notification.

#### ***ORDER ENTRY ONLINE BY CUSTOMER PART NUMBER***

### ***USING G24/7, YOU CAN QUICKLY AND EASILY:***

- Track the status of current orders
- Check the status of backorders
- Check for substitutions or replacements for obsolete parts
- Check Grote® inventory availability
- Confirm ship dates
- Link to shipping carrier
- View invoice information
- Track credits
- View weight & packaging information
- View previously placed orders
- View product technical information
- Reprint packing lists and invoices



# 16

## MISCELLANEOUS

*AUTRES*

*MISCELÁNEA*



### VINYL PERMIT HOLDER

Laminated for all-weather protection • Sealing zipper for easy insertion of paper

**43411** Vinyl

**Material:** Vinyl/Aluminum  
**Finish:** Green/Aluminum  
**VMRS Code:** 053-005-007

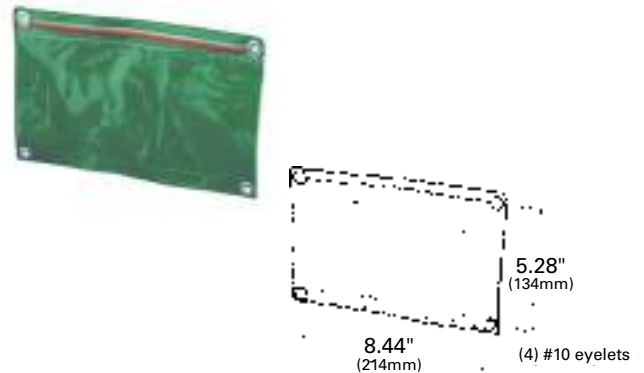

### ALUMINUM PERMIT HOLDER

Heavy-formed, rustproof housing • Includes vinyl pouch  
• 6 3/8" mounting screw hole spacing

**43424** Aluminum

**Material:** Aluminum w/ Vinyl Pouch  
**Accessory:** Vinyl Pouch: 43441  
**VMRS Code:** 053-005-007

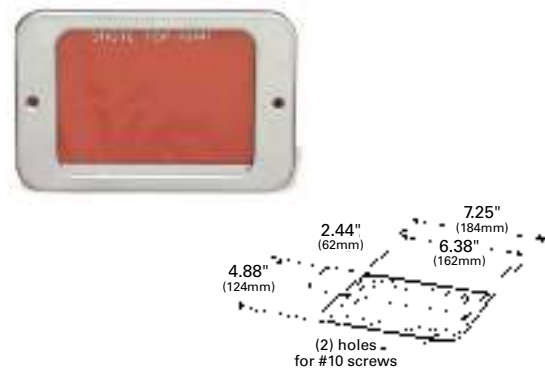

### DOCUMENT HOLDER

Rugged construction • Chemical-resistant, Ray-Ban® colored lens now has a darker tint • Comes with document protector polybag • Two mounting options for flexibility • Can be installed using pop-rivets

**43901** Gray

**Material:** Polycarbonate  
**Finish:** Gray/Smoke  
**Lens:** Smoke 93351  
**VMRS Code:** 053-005-007

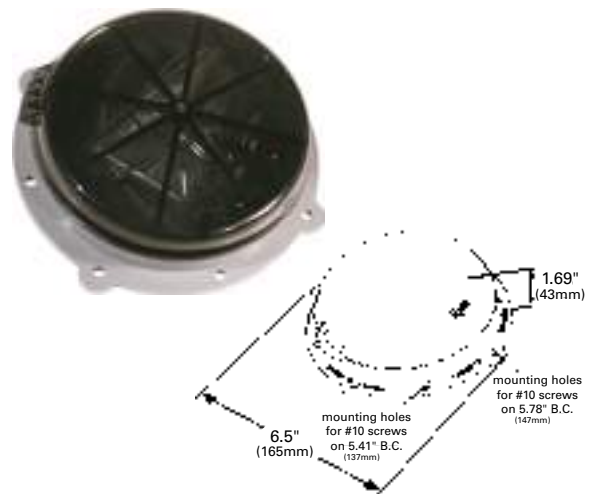

### ELECTRICAL SEALANT

Special dielectric silicone compound seals out moisture, salt and corrosives  
• Protects plug-ins and other electrical fittings

**99580** 1 1/4 Oz. Tube

**VMRS Code:** 053-999-096







99170



99180



99170-1

## ULTRA-SEAL CORROSION-PREVENTIVE SEALANT

Cost-effective product prevents rust and corrosion • Good mechanical stability • Added tackifiers improve adhesion and resistance to washout

- Has a 25% higher non-conductivity rating compared to the competition
- Operating range -40°F to 302°F

**99170** 4 oz. (118 ml.) Tube

**99180** 8 oz. (236 ml.) Tub

**99170-GT** 14 oz. (414 ml.) Tub

### RETAIL DISPLAY:

**99170-1** Display (12 of 99170)

**RETAIL**

**VMRS Code:** 053-999-096



## TRIANGLE WARNING KIT

Reflective up to 1/2 mile • Exceeds legal requirements • Weatherproof and impact-resistant • Weighted for stability • Kit of three triangle devices in carrying case

### KITS:

**71422** Three Triangles

**Material:** Acrylic/ABS/Polypropylene

**Regulations / Standards:** FMVSS 125 / SAE J774C™-Type I

**VMRS Code:** 053-004-005

### SLOW-MOVING VEHICLE EMBLEM

13 3/4" yellow-orange center for daytime warning • Outer 1 5/8" red reflex border for nighttime warning • 6" mounting screw hole spacing

**71152** Orange & Red

**Material:** Acrylic/ABS

**Standards:** SAE J943A™, ASAE S276.3

**Bracket:** 43325, 43335

**VMRS Code:** 053-004-005

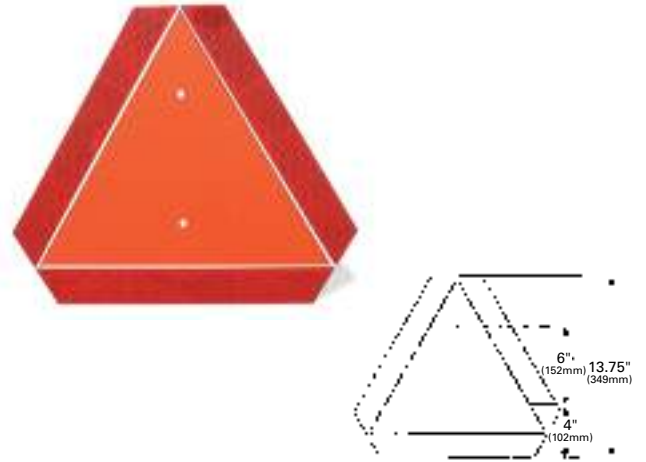

### TRAFFIC CONE

High visibility for traffic control • Fade-resistant, bright orange finish is molded of PVC to eliminate cracking and peeling

**71440** Small Cone

**71450** Large Cone

**Material:** PVC

**Finish:** Bright Orange

**VMRS Code:** 053-004-005

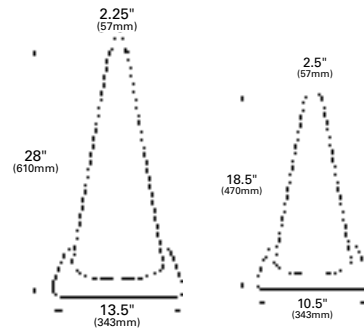

Ray-Ban® is a registered trademark of Luxottica Group S.P.A.  
All product and company names are trademarks™ or registered® trademarks of their

respective holders. Use of them does not imply any affiliation with or endorsement by them.

# 17

## TECHNICAL INFORMATION

*INFORMATION TECHNIQUE*

*INFORMACIÓN TÉCNICA*

## LIMITED WARRANTY

Grote® Industries, Inc. ("Grote®") warrants its products to be free from defects in material and workmanship under normal use and service as set forth in this Limited Warranty. THIS LIMITED WARRANTY is the final, complete and exclusive expression of warranty to the purchaser and cannot be modified except in writing signed by an authorized officer of Grote®.

## GENERAL ONE-YEAR LIMITED WARRANTY

Subject to the following conditions, Grote® warrants to the original purchaser only (and not to anyone else) of each new product made by Grote® that any part thereof which proves to be defective in material or workmanship within one year from the date of manufacture by Grote® will, at Grote's option, be repaired or replaced without charge upon return to Grote® of the defective product, provided any defect in the product is brought to the attention of Grote® within the warranty period, who alone will be authorized to furnish or arrange for repairs or replacements within the terms of this limited warranty.

The above limited warranty does not apply, and no warranty, either expressed or implied, shall be applicable (a) to damage resulting from accident, alteration, misuse or abuse; (b) if the product is not installed, operated and maintained according to procedures recommended by Grote®; (c) if the serial number, date code, or other identifying marks affixed to the product by Grote® are removed, obliterated or defaced. In no case shall the warranty be extended to defects in materials, components (which includes but not limited to bulbs), or services furnished by third parties, nor to the installation of the product performed by third parties, except those performed by or on behalf of Grote® authorized distributors. If any repairs are made, or any other parts are replaced during the warranty period, by any distributor other than a Grote® distributor, in accordance with service manuals, parts, accessories, or attachments other than authorized by Grote® for use in Grote's products, the purchaser shall pay for such repairs or parts without recourse against Grote®, and Grote® shall be relieved of responsibility for fulfillment of the warranty with respect to parts or components of all repairs, alterations, or replacements so made.

## INSTALLATION GUIDELINES

**Grote® Systems** - Grote® lamp assemblies and harness products are designed to function as a complete system; therefore, this limited warranty shall not extend to failure of any Grote® products caused by the use of incompatible lamp assemblies, harness products or other components.

**Heat** - All electronic and lighting products produce heat. The installer is responsible for assurance that the application of the component will not result in contact with flammable material.

**Surface Mount** - The following procedures need to be practiced to assure proper installation: The lamp should be placed on a level unobstructed surface. Number 10 screws should be tightened to 25 in. pounds of torque. Only Grote® ULTRA-BLUE-SEAL® pigtailed should interface with any Grote® lamps. These guidelines will assure the products will function and last as they were designed. Deviations from these guidelines will void any warranty.

**Design Voltage and Current** - Current is provided as an approximate value and is listed for the design voltage of the lamp. The design voltage of the lamp may vary. Customers should contact Grote® Industries if detailed information is required.

IN CONSIDERATION OF THE EXPRESS WARRANTY AND OTHER TERMS HEREIN CONTAINED, THE PURCHASER AGREES THAT PURCHASER'S EXCLUSIVE REMEDY AND GROTE'S SOLE

LIABILITY ON ANY CLAIM, WHETHER IN TORT, CONTRACT OR WARRANTY, SHALL BE LIMITED TO, AT GROTE'S OPTION, REPAIR OR REPLACEMENT OF A DEFECTIVE PRODUCT. NO OTHER REMEDY (INCLUDING BUT NOT LIMITED TO INCIDENTAL OR CONSEQUENTIAL DAMAGES FOR THE LOST PROFITS, LOST SALES, INJURY TO PERSON OR PROPERTY; OR ANY OTHER INCIDENTAL LOSS OR DAMAGES) SHALL BE AVAILABLE TO PURCHASER. IN NO EVENT, AND FOR NO CAUSE WHATSOEVER, INCLUDING ANY BREACH OR DEFAULT BY GROTE®, SHALL GROTE® HAVE ANY MONETARY LIABILITY TO PURCHASER IN EXCESS OF THE PRICE PAID BY PURCHASER FOR THE PRODUCT IN QUESTION.

THIS LIMITED WARRANTY IS EXPRESSLY IN LIEU OF ALL OTHER EXPRESSED OR IMPLIED WARRANTIES, INCLUDING THE IMPLIED WARRANTY OF MERCHANTABILITY AND THE IMPLIED WARRANTY OF FITNESS FOR A PARTICULAR PURPOSE, AND OF ALL OTHER OBLIGATIONS OR LIABILITIES ON THE PART OF GROTE®. NO DEALER, DISTRIBUTOR OR OTHER REPRESENTATIVE OF THE COMPANY IS AUTHORIZED TO CHANGE THIS WARRANTY IN ANY WAY OR TO GRANT ANY OTHER WARRANTY.

Any affirmation of fact or promise made by Grote® shall not be deemed to create an expressed warranty that the products shall conform to the affirmation or promise. Any description of the product is for the sole purpose of identifying such product and shall not be deemed to create an express warranty that the product shall conform to the description. Any sample or product model is for illustrative purposes only and shall not be deemed to create an express warranty that the whole of the products shall conform to the sample or model. Further, no affirmation or promise, or description, sample or model shall be deemed a part of the basis of the bargain between Grote® and the purchaser.

Grote® assumes no responsibility that title conveyed to the purchaser is good or the transfer of title to the products is rightful, or that the products shall be delivered free from any security interest or other lien or encumbrance of any third party, or free from any rightful claim of any third party by way of infringement or otherwise.

## NON-TRANSFERABLE

THIS WARRANTY SHALL EXTEND ONLY TO THE ORIGINAL PURCHASER AND IS NON-TRANSFERABLE.

## EXCEPTIONS

The general one-year (1) limited warranty shall apply but shall be altered as set forth below for the following products:

- (1) All Grote® Sealed Lamps (12 Volt Only) shall be subject to a two-year (2) limited warranty unless otherwise stated.
  - A) Grote® Economy sealed lamps shall be subject to a one-year (1) limited warranty.
- (2) Conspicuity Tape shall be subject to a five-year (5) or ten-year (10) limited warranty. Please refer to the Grote® reference guide and/or Grote® website for warranty time frame by part number.
- (3) Grote® LED Products are subject to the terms set forth below under "Special LED Limited Warranty."
- (4) Grote® ULTRA-BLUE-SEAL® Male Pin Wire Harnesses shall be subject to a seven-year (7) limited warranty.
- (5) Grote® ULTRA-BLUE-SEAL® Female Pin (Standard) Harnesses shall be subject to a five-year (5) limited warranty.
- (6) Grote® makes no warranty whatsoever with respect to bulbs and fluorescent tubes in lamp assemblies.
- (7) Grote® makes no warranty whatsoever with respect to any and all devices powered by common household-type batteries.

## SPECIAL LED LIMITED WARRANTY

Grote® LED lamps are covered by the Grote® Special LED Limited Warranty and are warranted to be free from defects in workmanship and/or material only for the specified time frames listed below. Grote® will replace any Grote® LED lamp to the original purchaser, if the Grote® LED lamp fails due to defects in workmanship and/or materials during the warranty time frame specified below:

THE LED LIMITED WARRANTY DOES NOT APPLY TO SEVERE APPLICATIONS. Examples: Mining, Snow plowing and Fertilizers.

- (1) Grote® LED lamps are to REMAIN INTACT, FREE FROM PHYSICAL ABUSE, SUBJECT TO PROPER INSTALLATION WITHOUT MODIFICATION AND MUST BE USED ONLY WITH GROTE® APPROVED WIRING ACCESSORIES. ANY VIOLATION OF THESE CONDITIONS WILL VOID THIS LED LIMITED LAMP WARRANTY. For guidance regarding proper installation, please see above under "Surface Mount Installation Guidelines".
- (2) ANY DAMAGE OR CRACKING DUE TO CHEMICALS OR INCOMPATIBLE CLEANERS WILL VOID THIS WARRANTY.
- (3) Grote® LED lamps are designed to work in conjunction with the Grote® ULTRA-BLUE SEAL® Wire Harness System including Grote® factory molded pigtailed for use with the Grote® ULTRA-BLUE SEAL® Wire Harness System. Therefore, Grote® LED lamps have a Limited Warranty based on the following criteria:
  - A – Grote® SuperNova® high performance LED lamps are covered by a ten-year (10) Limited Warranty when installed with male pin, hard shell or patented double-seal pigtail connectors.
  - 1) Grote® SuperNova® high performance LED lamps are covered by a three-year (3) Limited Warranty when installed with hardwire bullet connectors.

2) Grote® SuperNova® high performance LED lamps are covered by a two-year (2) Limited Warranty when installed with hardwire termination.

- B – Grote® MicroNova® high performance LED lamps are covered by a three-year (3) Limited Warranty when installed with hardwire bullet connectors.
- C – Grote® Hi Count® LED lamps (part numbers that begin with a G) are covered by a two-year (2) Limited Warranty.
- D – Grote® WhiteLight LED lamps are covered by a three-year (3) Limited Warranty.
- E – Grote Select® high value LED Stop/Tail/Turn and Back-up lamps are covered by a two-year (2) Limited Warranty. Grote Select® LED Flood Lamps are covered by a one-year (1) Limited Warranty.
- F – Grote Brite Zone® LED lamps are covered by a two-year (2) Limited Warranty.
- G – Grote® Warning & Hazard LEDs are covered by a two-year (2) Limited Warranty.
  - 1) Any and all LED Devices powered by common household-type batteries are not covered by Grote's Limited Warranty.
- H – Other Grote® LED lamps for FMVSS applications excluding SuperNova®, MicroNova®, WhiteLight and Hi Count® are covered by a two-year (2) Limited Warranty.
- I – Other Grote® LED lamps (non-FMVSS) are covered by a one-year (1) Limited Warranty.
- J – Grote® XTL® products are covered by a one-year (1) Limited Warranty.

| LED Brand Category           | Termination Style |            |            |                                  |          |                                  |
|------------------------------|-------------------|------------|------------|----------------------------------|----------|----------------------------------|
|                              | Male Pin          | Hard Shell | Female Pin | Hardwire w/<br>Bullet Connectors | Hardwire | Patented Double-<br>Seal Pigtail |
| Grote® SuperNova®            | 10                | 10         | N/A        | 3                                | 2        | 10                               |
| Grote® MicroNova®            | N/A               | N/A        | N/A        | 3                                | N/A      | N/A                              |
| Grote® Hi Count®             | N/A               | N/A        | 2          | N/A                              | 2        | N/A                              |
| Grote® WhiteLight            | 3                 | 3          | 3          | 3                                | 3        | N/A                              |
| Grote Select®                | N/A               | N/A        | 2          | N/A                              | 1        | 2                                |
| Grote® XTL®                  | N/A               | 1          | N/A        | 1                                | 1        | N/A                              |
| Grote® Brite Zone®           | N/A               | N/A        | N/A        | N/A                              | 2        | N/A                              |
| Grote® Warning & Hazard LEDs | 2                 | N/A        | N/A        | 2                                | 2        | N/A                              |
| Grote® LEDs (FMVSS)          | 2                 | N/A        | 2          | 2                                | 2        | N/A                              |
| Grote® LEDs (non-FMVSS)      | N/A               | N/A        | N/A        | 1                                | 1        | N/A                              |

N/A - Not Available or None

Number represents the years of warranty from manufacture date

## QUALITY SYSTEMS:

Product within the catalog may be manufactured under various quality system certifications. If a customer requires particular quality certifications on specific products, they may contact Grote® Industries for detailed information.

## END USER RESPONSIBILITY:

Each user bears full responsibility for making their own determination as to the suitability of Grote® materials, products, recommendations, or advice for their own particular use. Each user is ultimately responsible to identify and perform tests and analyses necessary to assure that its finished parts incorporating Grote® products will be safe and suitable for use under end-user conditions. Nothing in this or any other document, nor any oral recommendation or advice, shall be deemed to alter, vary, supersede, or waive any provision of this Limited Warranty or this Disclaimer, unless any such modification is specifically agreed to in writing signed by a Grote® Industries Representative.



**INTELLECTUAL PROPERTY:**

No statement contained herein concerning a possible or suggested use of any material, product or design is intended, or should be construed, to grant any license under any patent or other intellectual property right of Grote® Industries or any of its subsidiaries or affiliates covering such use or design, or as a recommendation for the use of such material, product or design in the infringement of any patent or other intellectual property right.

The information in this catalog is deemed correct at the time of publication and is provided in good faith. There may be inaccuracies due to legislative changes, competitive part number changes, technological advances or typographical errors. Customers should contact Grote® Industries for updated information.

**WARRANTY RETURN AND REPLACEMENT INSTRUCTIONS**

To be eligible for limited warranty consideration, either contact your Grote® sales representative or call Grote® customer service at **800.628.0809** (in Canada, call **800.268.5612**). Upon issuance of a returned goods authorization number, return the failed product, freight prepaid to: Warranty at Grote® Industries, Inc., 2600 Lanier Drive, Madison, Indiana 47250. In Canada, return product, freight prepaid to: Warranty at Grote® Industries Co., 230 Travail Road, Markham, Ontario L3S 3J1. Any product covered under the terms of the respective limited warranty will be replaced directly to the original consumer/purchaser only. Items received by Grote® will not be returned unless accompanied by a specific written request. The product to be returned will be those items not covered under the warranty and will be returned to sender freight collect.

**CONSUMER RIGHTS IN VARIOUS STATES**

This warranty gives you specific legal rights, and you may have other rights that vary from state to state. Some states do not allow limitations on how long an implied warranty lasts, so the above limitations may not apply to you. Further, some states do not allow the exclusion or limitation of incidental or consequential damages so the above limitation or exclusion may not apply to you.

Effective October 1, 2019

**TRUCK-LITE®-TO-GROTE® INTERCHANGE**

| Truck-Lite® PN | Grote® Form, Fit & Function | Grote® Fit & Function |
|----------------|-----------------------------|-----------------------|
| 41             | 40232                       |                       |
| 43             | 40192                       |                       |
| 45             | 41002                       |                       |
| 52             | 41012                       |                       |
| 54             | 41032                       |                       |
| 172            | 44530                       |                       |
| 173            | 44540                       |                       |
| 182            | 44690                       |                       |
| 183            | 44700                       |                       |
| 262            | 44810                       |                       |
| 263            | 44820                       |                       |
| 266            | 44730                       |                       |
| 270            | 44010                       |                       |
| 275            | 44010                       |                       |
| 276            | 44030                       |                       |
| 282            | 44710                       |                       |
| 283            | 44720                       |                       |
| 285            | 44891                       |                       |
| 320            | 73140-5                     |                       |
| 528            | 52492                       |                       |
| 529            | 52482                       |                       |
| 540            | 50852                       |                       |
| 541            | 50862                       |                       |
| 794            | 49140                       |                       |
| 797            | 71152                       |                       |
| 798            | 71422                       |                       |
| 900            | 48072                       |                       |
| 901            | 48072                       |                       |
| 902            | 48072                       |                       |
| 905            | 48272                       |                       |
| 910            | 48072                       |                       |
| 1050           | G1032                       |                       |
| 1052           | G1002                       |                       |
| 1058           | 47122                       |                       |
| 1075           | G1082                       |                       |
| 1203           | 46782                       |                       |
| 1211           | 46792                       |                       |
| 1213           | 46792                       |                       |
| 1215           | 49082                       |                       |
| 1222           | 45932                       |                       |
| 1233           | 45462                       |                       |
| 1259           | 45262                       |                       |
| 1264           | 45932                       |                       |
| 1507           | 46882                       |                       |
| 1520           | 45512                       |                       |
| 1560           | G1502                       |                       |
| 1960           | 47092                       |                       |
| 2150           | G2102                       |                       |
| 2660           | G4602                       |                       |
| 2702           | 53052                       |                       |
| 2750           | G5300                       |                       |
| 2758           | G5540                       |                       |
| 2759           | G5530                       |                       |
| 2803           | 53020                       |                       |
| 3050           | G3002                       |                       |
| 3058           | 47112                       |                       |
| 3070           |                             | G3002 + 43150         |
| 3612           | 52522                       |                       |
| 3616           | 52522                       |                       |
| 3801           | 56000                       |                       |
| 3802           | 56000                       |                       |
| 3806           | 56000                       |                       |
| 3812           | 53000                       |                       |
| 3850           | 55220                       |                       |
| 3860           | 55280                       |                       |
| 3861           | 55290                       |                       |
| 3863           | 50630                       |                       |
| 4015           | 50942                       |                       |
| 4016           | 50952                       |                       |
| 4017           | 50952                       |                       |

| Truck-Lite® PN | Grote® Form, Fit & Function | Grote® Fit & Function |
|----------------|-----------------------------|-----------------------|
| 4018           | 50942                       |                       |
| 4023           | 52902                       |                       |
| 4024           | 52912                       |                       |
| 4025           | 52832                       |                       |
| 4026           | 52822                       |                       |
| 4027           | 50972                       |                       |
| 4028           | 52602                       |                       |
| 4050           | G4002                       |                       |
| 4051           | G4022                       |                       |
| 4058           | 54342                       |                       |
| 4095           | 66905                       |                       |
| 4550           | G4502                       |                       |
| 4558           | G4502                       |                       |
| 4742           | 55420                       |                       |
| 4854           | 55450                       |                       |
| 4855           | 55460                       |                       |
| 5015           | 53722                       |                       |
| 5070           | G5092                       |                       |
| 5071           | G5082                       |                       |
| 5072           | G5212                       |                       |
| 6050           | G6002                       |                       |
| 6051           | G6012                       |                       |
| 6053           | 53592                       |                       |
| 6058           | G6002                       |                       |
| 6503           | 56072                       |                       |
| 7038           | 12201-5                     |                       |
| 7039           | 12004                       |                       |
| 7223           | 12263-5                     |                       |
| 7224           | 12263-5                     |                       |
| 8004           |                             | 64261-4               |
| 8140           | 64G01                       |                       |
| 8150           | 63871                       |                       |
| 8155           | 63601                       |                       |
| 8160           | BZ201-5                     |                       |
| 8170           | BZ201-5                     |                       |
| 8180           | 63F81                       |                       |
| 8861           | 99912                       |                       |
| 8909           | 90232                       |                       |
| 8933           | 90202                       |                       |
| 8938           | 91502                       |                       |
| 9004           | 90302                       |                       |
| 9005           | 90052                       |                       |
| 9006           | 91962                       |                       |
| 9007           | 91962                       |                       |
| 9016           | 91582                       |                       |
| 9021           | 91582                       |                       |
| 9029           | 90012                       |                       |
| 9040           | 92172                       |                       |
| 9049           | 91302                       |                       |
| 9057           | 91992                       |                       |
| 9063           | 91502                       |                       |
| 9071           | 91302                       |                       |
| 9079           | 91502                       |                       |
| 9093           | 90122                       |                       |
| 9101           | 68130                       |                       |
| 9102           | 68170                       |                       |
| 9104           | 68080                       |                       |
| 9105           | 68130                       |                       |
| 9107           | 68110                       |                       |
| 9162           | 68080                       |                       |
| 9179           | 43673                       |                       |
| 9180           | 94110                       |                       |
| 9536           | 51012                       |                       |
| 9537           | 51002                       |                       |
| 9944           |                             | 77931                 |
| 10401          | 94010                       |                       |
| 10403          |                             | 67050 + 92920         |
| 10410          |                             | 42180 + 66850         |
| 10413          |                             | 43690 + 67050         |
| 10414          |                             | 93750 + 67001         |
| 10702          | 92070                       |                       |
| 10704          | 91410                       |                       |
| 10708          | 92920                       |                       |

**TRUCK-LITE® - TO-GROTE®  
INTERCHANGE**

| Truck-Lite® PN | Grote® Form, Fit & Function | Grote® Fit & Function |
|----------------|-----------------------------|-----------------------|
| 10713          | 91400                       |                       |
| 10714          | 92070                       |                       |
| 10721          |                             | 42180                 |
| 10725          |                             | 93750                 |
| 10727          |                             | 42180                 |
| 10728          | 43690                       |                       |
| 10729          |                             | 43512                 |
| 10730          | 43522                       |                       |
| 14701          | 93402                       |                       |
| 15054          | 60381                       |                       |
| 15058          | 60341                       |                       |
| 15060          | 60381                       |                       |
| 15208          | 60261                       |                       |
| 15227          | 60671                       |                       |
| 15404          | 43970                       |                       |
| 15405          | 43970                       |                       |
| 15412          | 43370                       |                       |
| 15413          | 43370                       |                       |
| 15414          | 43380                       |                       |
| 15702          | 91380                       |                       |
| 15727          | 43370                       |                       |
| 15728          | 43380                       |                       |
| 15729          | 43830                       |                       |
| 15730          | 43830                       |                       |
| 15733          | 43370                       |                       |
| 17003          | 60191                       |                       |
| 17200          | 60191                       |                       |
| 19206          | 60291                       |                       |
| 19721          | 43850                       |                       |
| 19723          | 43120                       |                       |
| 19724          | 43120                       |                       |
| 19736          | 43120                       |                       |
| 26330          | 60151                       |                       |
| 26331          | 60101-5                     |                       |
| 26335          | 60001                       |                       |
| 26336          | 60251                       |                       |
| 26371          | 60001-3                     |                       |
| 27270          | 90941-5                     |                       |
| 27450          | 90941-5                     |                       |
| 30286          | 77193                       |                       |
| 30401          | 94100                       |                       |
| 30402          | 92150                       |                       |
| 30404          | 93750                       |                       |
| 30405          | 93760                       |                       |
| 30407          | 43690                       |                       |
| 30700          | 92120                       |                       |
| 30701          | 92120                       |                       |
| 30702          | 92150                       |                       |
| 30704          | 92150                       |                       |
| 30711          | 92120                       |                       |
| 30721          | 93750                       |                       |
| 30722          | 93760                       |                       |
| 30726          | 93760                       |                       |
| 30727          | 43690                       |                       |
| 30728          | 43532                       |                       |
| 30729          | 93750                       |                       |
| 33711          | 42110                       |                       |
| 33712          | 94350                       |                       |
| 40012          | 62321                       |                       |
| 40044          | 62181                       |                       |
| 40203          | 61051                       |                       |
| 40204          | 62271                       |                       |
| 40212          | 62321                       |                       |
| 40244          | 62171                       |                       |
| 40403          | 91740                       |                       |
| 40700          | 91740                       |                       |
| 40715          | 43642                       |                       |
| 40720          | 43572                       |                       |
| 40725          | 43655                       |                       |

| Truck-Lite® PN | Grote® Form, Fit & Function | Grote® Fit & Function       |
|----------------|-----------------------------|-----------------------------|
| 40756          | 51032                       |                             |
| 40757          | 51022                       |                             |
| 40850          | 50820                       |                             |
| 42722          | 43272                       |                             |
| 44101          | 77363                       |                             |
| 44102          | 77362                       |                             |
| 44114          | 77352                       |                             |
| 44705          | 43343                       |                             |
| 45700          | 94180                       |                             |
| 45701          | 43642                       |                             |
| 45720          | 43212                       |                             |
| 50202          |                             | 01-6757-R3                  |
| 50203          |                             | 01-6761-T9                  |
| 50301          |                             | 01-6620-95                  |
| 50303          |                             | 01-6620-U9                  |
| 50304          |                             | 05-2005-54                  |
| 50307          | 05-2013-25                  |                             |
| 50309          |                             | 01-3650-U9                  |
| 50325          |                             | 01-6682-72 or<br>01-6682-73 |
| 50342          | 01-6682-72                  |                             |
| 50343          | 01-6682-73                  |                             |
| 50831          | 93190                       |                             |
| 50860          | 87860                       |                             |
| 50896          | 87250                       |                             |
| 60120          | 47472                       |                             |
| 60403          |                             | 92420 + 67090               |
| 60700          | 92420                       |                             |
| 60704          | 92720                       |                             |
| 60719          | 42103                       |                             |
| 60720          | 43362                       |                             |
| 60722          | 43952                       |                             |
| 60723          | 43362                       |                             |
| 60728          | 43952                       |                             |
| 60730          | 43362                       |                             |
| 60733          | 43952                       |                             |
| 60734          | 77363                       |                             |
| 70300          | 55220                       |                             |
| 70311          | 50630                       |                             |
| 80220          | 63971                       |                             |
| 80304          | 50222                       |                             |
| 80340          | 62011                       |                             |
| 80344          | 62151                       |                             |
| 80350          | 61821                       |                             |
| 80352          | 61821                       |                             |
| 80360          | 64931-5                     |                             |
| 80361          | 64931-5                     |                             |
| 80364          | 64441                       |                             |
| 80373          | 64921                       |                             |
| 80394          | 64891                       |                             |
| 80395          | 64891                       |                             |
| 80396          | 64891                       |                             |
| 80438          | 64931-5                     |                             |
| 80444          | 61371                       |                             |
| 80482          | 61161                       |                             |
| 80490          | 61031                       |                             |
| 80493          | 64H01-5                     |                             |
| 80513          | 06021-4                     |                             |
| 80514          | 06021-4                     |                             |
| 80525          | 06021-4                     |                             |
| 80561          | 91051                       |                             |
| 80567          |                             | 05001-5                     |
| 80568          |                             | 05001-5                     |
| 80571          | 90971-5                     |                             |
| 80591          | 05001-5                     |                             |
| 80720          | 43262-5                     |                             |
| 80722          | 43262-5                     |                             |
| 80800          | 64291-4                     |                             |
| 80805          | 64291-4                     |                             |
| 80878          | 78563                       |                             |
| 80879          | 78563                       |                             |
| 80888          | 64261-4                     |                             |
| 80893          | 64261-4                     |                             |

| Truck-Lite® PN | Grote® Form, Fit & Function | Grote® Fit & Function |
|----------------|-----------------------------|-----------------------|
| 80900          |                             | 64261-4               |
| 80910          | 64241                       |                       |
| 80920          | 64251                       |                       |
| 80930          |                             | 64261-4               |
| 80940          |                             | 64261-4               |
| 80950          | 64241                       |                       |
| 80951          | 64251                       |                       |
| 80952          | 64241                       |                       |
| 80953          | 64251                       |                       |
| 80954          | 64241                       |                       |
| 80955          | 64251                       |                       |
| 80956          | 64241                       |                       |
| 80957          | 64251                       |                       |
| 80958          | 64241                       |                       |
| 80959          | 64251                       |                       |
| 80960          | 64241                       |                       |
| 80961          | 64251                       |                       |
| 81380          | 64E01                       |                       |
| 81500          | 63F21 or 63F71              |                       |
| 81510          | 63981 or 63991              |                       |
| 81520          | BZ601-5                     |                       |
| 81702          | 63H81                       |                       |
| 81704          | 63H81                       |                       |
| 81712          | 63H11                       |                       |
| 81804          | 63H81                       |                       |
| 91242          | 56072                       |                       |
| 92550          | 77193                       |                       |
| 92560          | 77013                       |                       |
| 92563          | 77013                       |                       |
| 92600          | 77003                       |                       |
| 92602          | 76983                       |                       |
| 92674          | 77931                       |                       |
| 92677          | 77931                       |                       |
| 92871          | 77351                       |                       |
| 92884          | 77931                       |                       |
| 92885          | 77353                       |                       |
| 92900          | 73040                       |                       |
| 92901          | 73040                       |                       |
| 92902          | 73090                       |                       |
| 92904          | 73030                       |                       |
| 92905          | 73080                       |                       |
| 92909          | 73040                       |                       |
| 92910          | 73040                       |                       |
| 92911          | 73110                       |                       |
| 92918          | 73160                       |                       |
| 92924          | 73090                       |                       |
| 92925          | 44421                       |                       |
| 94706          | 66830                       |                       |
| 94707          | 66861                       |                       |
| 94718          | 66930                       |                       |
| 94729          | 66981                       |                       |
| 94750          | 66810                       |                       |
| 94802          | 66811                       |                       |
| 94850          | 66800                       |                       |
| 94853          | 66820                       |                       |
| 94862          | 66930                       |                       |
| 94882          | 66844                       |                       |
| 94897          | 66831                       |                       |
| 94902          | 67050                       |                       |
| 94909          | 67050                       |                       |
| 94916          | 67050                       |                       |
| 94919          | 67050                       |                       |
| 94924          | 67050                       |                       |
| 94925          | 67010                       |                       |
| 94926          | 67000                       |                       |
| 94931          |                             | 67090                 |
| 94932          | 66810                       |                       |
| 94940          | 68380                       |                       |
| 94961          | 67011                       |                       |
| 94962          | 66812                       |                       |
| 94964          | 66801                       |                       |
| 94972          | 66801                       |                       |
| 94992          | 67010                       |                       |

**TRUCK-LITE®-TO-GROTE®  
INTERCHANGE**

| Truck-Lite® PN | Grote® Form, Fit & Function | Grote® Fit & Function |
|----------------|-----------------------------|-----------------------|
| 94993          | 67090                       |                       |
| 96106          | 66910                       |                       |
| 96107          | 67002                       |                       |
| 96930          | 66360                       |                       |
| 96960          | 66160                       |                       |
| 97005          | 66931                       |                       |
| 97224          |                             | 64261-4               |
| 97252          | 77363                       |                       |
| 97283          | 44090                       |                       |
| 97334          | 92513                       |                       |
| 97360          | 72110-5                     |                       |
| 97361          | 72100-5                     |                       |
| 97609          | 12020                       |                       |
| 97610          | 12020                       |                       |
| 97611          | 28162                       |                       |
| 97612          | 28031                       |                       |
| 97619          | 28162                       |                       |
| 97620          | 28031                       |                       |
| 97621          | 28663                       |                       |
| 97623          | 28041                       |                       |
| 97624          | 16284                       |                       |
| 97625          | 16294                       |                       |
| 97627          | 16244                       |                       |
| 97628          | 16244                       |                       |
| 97629          | 16202                       |                       |
| 97631          | 16173                       |                       |
| 97632          | 16043                       |                       |
| 97633          | 28393-5                     |                       |
| 97636          | 16142                       |                       |
| 97653          | 12073                       |                       |
| 97654          | 12072                       |                       |
| 97655          | 12243-5                     |                       |
| 97659          | 12193-5                     |                       |
| 97660          | 12111-5                     |                       |
| 97669          | 28453                       |                       |
| 97670          | 12333                       |                       |
| 97671          | 12331                       |                       |
| 97672          | 12303                       |                       |
| 97673          | 12301                       |                       |
| 97674          | 12333                       |                       |
| 97675          | 12333                       |                       |
| 97676          | 12331                       |                       |
| 97687          | 28443                       |                       |
| 97688          | 12153                       |                       |
| 97693          | 26012-5                     |                       |
| 97695          | 16041                       |                       |
| 97718          | 11303                       |                       |
| 97721          | 10025                       |                       |
| 97725          | 22233                       |                       |
| 97726          | 22232                       |                       |
| 97733          | 11293                       |                       |
| 97802          | 28032                       |                       |
| 97803          | 16033                       |                       |
| 97804          | 16032                       |                       |
| 97805          | 12113-5                     |                       |
| 97806          | 16091                       |                       |
| 97807          | 12071                       |                       |
| 97808          | 16101                       |                       |
| 97809          | 16053                       |                       |
| 97811          | 16092                       |                       |
| 97812          | 16023                       |                       |
| 97817          | 12173                       |                       |
| 97818          | 16102                       |                       |
| 97820          | 28042                       |                       |
| 97822          | 16093                       |                       |
| 97823          | 10173                       |                       |
| 97826          | 16063                       |                       |
| 97827          | 16223                       |                       |
| 97828          | 10173                       |                       |
| 97829          | 22193                       |                       |

| Truck-Lite® PN | Grote® Form, Fit & Function | Grote® Fit & Function |
|----------------|-----------------------------|-----------------------|
| 97831          | 12272-5                     |                       |
| 97835          | 12020                       |                       |
| 97840          | 28461                       |                       |
| 97843          | 22013                       |                       |
| 97845          | 29060                       |                       |
| 97846          | 28193                       |                       |
| 97847          | 12303                       |                       |
| 97848          | 12333                       |                       |
| 97860          | 16023                       |                       |
| 97861          | 16273                       |                       |
| 97862          | 28493                       |                       |
| 97863          | 12010                       |                       |
| 97865          | 28763                       |                       |
| 97866          | 16153                       |                       |
| 97869          | 10623                       |                       |
| 97940          | 99180                       |                       |
| 97960          | 43901                       |                       |
| 97989          | 64890                       |                       |
| 98100          | 40641                       |                       |
| 98101          | 40650                       |                       |
| 98104          | 40650-5                     |                       |
| 98105          | 40641-5                     |                       |
| 98107          | 41080                       |                       |
| 98127          | 41160                       |                       |
| 98136          | 40650                       |                       |
| 98137          | 40641                       |                       |
| 98153          | 41121                       |                       |
| 98165          | 41133                       |                       |
| 1001D          | 45022                       |                       |
| 10028R         | 45072                       |                       |
| 10028Y         | 45073                       |                       |
| 10050R         | 47472                       |                       |
| 10050Y         | 47473                       |                       |
| 10051R         | 47202 + 66840               |                       |
| 10075R         |                             | 47232 + 91400 + 66840 |
| 10075Y         |                             | 47233 + 91400 + 66840 |
| 10076R         |                             | 47232 + 91400 + 66850 |
| 10076Y         |                             | 47233 + 91400 + 66850 |
| 10079R         |                             | 47372 + 66840         |
| 10079Y         |                             | 47373 + 66840         |
| 10085R         |                             | 47232 + 91400 + 66850 |
| 10085Y         |                             | 47233 + 91400 + 66850 |
| 10086R         |                             | 47232 + 91400 + 66850 |
| 10086Y         |                             | 47233 + 91400 + 66850 |
| 10089R         |                             | 47373 + 66850         |
| 10089Y         |                             | 47373 + 66850         |
| 10090R         |                             | 47232 + 91400 + 66850 |
| 10090Y         |                             | 47233 + 91400 + 66850 |
| 10091R         |                             | 47372 + 66850         |
| 10091Y         |                             | 47373 + 66850         |
| 10092R         |                             | 47232 + 43162 + 66850 |
| 10092Y         |                             | 47233 + 43162 + 66850 |
| 10202C         | 45811                       |                       |
| 10202R         | 45812                       |                       |
| 10202Y         | 45813                       |                       |
| 10203R         | 45322                       |                       |
| 10203Y         | 45323                       |                       |
| 10209C         | 45811                       |                       |
| 10212Y         | 78343                       |                       |
| 10213Y         | 78343                       |                       |
| 10250R         | 47122                       |                       |
| 10250Y         |                             | 47123 + 67001         |
| 10251R         |                             | 47122 + 43160         |

| Truck-Lite® PN | Grote® Form, Fit & Function | Grote® Fit & Function |
|----------------|-----------------------------|-----------------------|
| 10251Y         |                             | 47123 + 43160         |
| 10275R         | 47232                       |                       |
| 10275Y         | 47233                       |                       |
| 10276R         | G3092                       |                       |
| 10276Y         | 47223                       |                       |
| 10279R         | 47372                       |                       |
| 10279Y         | 47373                       |                       |
| 10286R         | 46142                       |                       |
| 10286Y         | 46143                       |                       |
| 10288Y         |                             | 47423 + 66840         |
| 10289R         |                             | 47372 + 66840         |
| 10289Y         |                             | 47373 + 66840         |
| 10379R         | 47372                       |                       |
| 10379Y         | 47373                       |                       |
| 10389R         | 47372                       |                       |
| 10389Y         | 47373                       |                       |
| 10391R         |                             | 47232 + 43162         |
| 10391Y         |                             | 47233 + 43162         |
| 1050A          | G1033                       |                       |
| 10519R         | 45042                       |                       |
| 10519Y         | 45043                       |                       |
| 1051A          | G1043                       |                       |
| 10520R         |                             | 93750 + 45812 + 67050 |
| 10525R         | 45072                       |                       |
| 10525Y         | 45073                       |                       |
| 1052A          | G1003                       |                       |
| 1058-3         | 47122-3                     |                       |
| 1058A          | 47123                       |                       |
| 1058A-3        | 47123-3                     |                       |
| 1070A          | 47373                       |                       |
| 1071A          | 47373                       |                       |
| 10744R         | 49142                       |                       |
| 1075A          | G1083                       |                       |
| 1155A          | G5053                       |                       |
| 1203A          | 46783                       |                       |
| 1211A          | 46793                       |                       |
| 1211W          | 46791                       |                       |
| 1213A          | 46793                       |                       |
| 1222A          | 45933                       |                       |
| 1233A          | 45463                       |                       |
| 1259A          | 45263                       |                       |
| 1264A          | 45933                       |                       |
| 1312A          | 45333                       |                       |
| 1320AD         | 46543-5                     |                       |
| 14200R         | 45232                       |                       |
| 14200Y         | 45233                       |                       |
| 15006R         | 43370                       |                       |
| 15006Y         | 43370                       |                       |
| 15008R         | 43380                       |                       |
| 15008Y         | 43380                       |                       |
| 15011UB        | 60280                       |                       |
| 15050R         | 49182                       |                       |
| 1507A          | 46883                       |                       |
| 15200C         | 60271                       |                       |
| 15200R         | 46412                       |                       |
| 15200Y         | 46413                       |                       |
| 15201R         | 45162                       |                       |
| 15201Y         | 45163                       |                       |
| 15208UB        | 60261                       |                       |
| 1520A          | 45513                       |                       |
| 15250R         | 47082                       |                       |
| 15250Y         | 47083                       |                       |
| 15506R         | 45082                       |                       |
| 15506Y         | 46422-5                     |                       |
| 1555A          | 45253                       |                       |
| 1560A          | G1503                       |                       |
| 1570A          | 46393                       |                       |
| 15741R         | 49172                       |                       |
| 15745R         | 49172                       |                       |
| 18300Y         |                             | 45713                 |
| 19200C         | 60301                       |                       |
| 19200R         | 46742                       |                       |

**TRUCK-LITE®-TO-GROTE®  
INTERCHANGE**

| Truck-Lite® PN | Grote® Form, Fit & Function | Grote® Fit & Function |
|----------------|-----------------------------|-----------------------|
| 19200Y         | 46743                       |                       |
| 19205Y         | 78393                       |                       |
| 19250R         | 47092                       |                       |
| 19250Y         | G1903                       |                       |
| 19275R         | 47492                       |                       |
| 19275Y         | 47493                       |                       |
| 19350R         |                             | 47492                 |
| 19350Y         |                             | 47093 + 66981         |
| 19375Y         |                             | G1903                 |
| 1960A          | G1903                       |                       |
| 21002R         | 46082                       |                       |
| 21002Y         | 46083                       |                       |
| 21051R         |                             | 47072 + 66910         |
| 21051Y         |                             | 47073 + 66910         |
| 21201R         | 46072                       |                       |
| 21201Y         | 46073                       |                       |
| 21210Y         | 78363                       |                       |
| 21251R         | 47072                       |                       |
| 21251Y         | 47073                       |                       |
| 21271R         |                             | 54002 + 66815         |
| 21275R         | 47162                       |                       |
| 21275Y         | 47163                       |                       |
| 21506R         |                             | 46832 + 66910         |
| 21506Y         |                             | 46833 + 66910         |
| 21507R         |                             | 46872 + 66910         |
| 21507Y         |                             | 46873 + 66910         |
| 2150A          | G2103                       |                       |
| 21880R         | 47072                       |                       |
| 21880Y         | 47073                       |                       |
| 22002R         |                             | 53062 + 66905         |
| 22002Y         |                             | 52193 + 66843         |
| 22004Y         |                             | 53063 + 66905         |
| 22006Y         |                             | 53063                 |
| 25250Y         | 47063                       |                       |
| 25750Y         | 47063                       |                       |
| 25760Y         | 45503                       |                       |
| 25761Y         | 46813                       |                       |
| 25765Y         | 46913                       |                       |
| 25766Y         | 46913                       |                       |
| 26311R         | 46282                       |                       |
| 26311Y         | 46283                       |                       |
| 26315R         | 45172                       |                       |
| 26315Y         | 45173                       |                       |
| 263-4          | 44860                       |                       |
| 26394C         | 60361                       |                       |
| 2660A          | G4603                       |                       |
| 26741R         | 49002                       |                       |
| 26760Y         | 45993                       |                       |
| 26762Y         | 92773                       |                       |
| 26765Y         | 46543                       |                       |
| 27270C         | 90941-5                     |                       |
| 27450C         | 90951-5                     |                       |
| 27640C         | 94421-5                     |                       |
| 27645C         | 94411-5                     |                       |
| 29004C         |                             | 60331 + 66911         |
| 29202R         | 45442                       |                       |
| 29202Y         | 45443                       |                       |
| 29204C         | 60331                       |                       |
| 30075R         |                             | 46132 + 92120 + 67050 |
| 30075Y         |                             | 46133 + 92120 + 67050 |
| 30085R         |                             | 46132 + 92120 + 67050 |
| 30085Y         |                             | 46133 + 92120 + 67050 |
| 30086Y         |                             | 47113 + 92120 + 67050 |
| 30090R         |                             | 46132 + 42180 + 67050 |

| Truck-Lite® PN | Grote® Form, Fit & Function | Grote® Fit & Function |
|----------------|-----------------------------|-----------------------|
| 30090Y         |                             | 46133 + 42180 + 67050 |
| 30091R         |                             | G3002 + 43150 + 67050 |
| 30091Y         |                             | G3003 + 43150 + 67050 |
| 300A           | 77103                       |                       |
| 30200C         | 45821                       |                       |
| 30200R         | 45822                       |                       |
| 30200Y         | 45823                       |                       |
| 30201R         | 47102                       |                       |
| 30201Y         | 47103                       |                       |
| 30204R         | 45822                       |                       |
| 30204Y         | 45823                       |                       |
| 30222R         |                             | 45822 + 43150         |
| 30230Y         | 78333                       |                       |
| 30257Y         | 78333                       |                       |
| 30264Y         | 78433                       |                       |
| 30269Y         |                             | 78433 + 43150         |
| 30272R         |                             | 47112 + 43150         |
| 30272Y         |                             | 47113 + 43150         |
| 30276R         | 47212                       |                       |
| 30276Y         | 47213                       |                       |
| 30277R         |                             | 47112 + 43152         |
| 30277Y         |                             | 47113 + 43152         |
| 30279R         |                             | 46142 + 67050         |
| 30279Y         |                             | 46143 + 67050         |
| 30286Y         | 77193                       |                       |
| 30288R         |                             | G3002 + 43152 + 67050 |
| 30288Y         |                             | G3003 + 43152 + 67050 |
| 30289R         |                             | G3002 + 43152 + 67050 |
| 30289Y         |                             | G3003 + 43152 + 67050 |
| 30375R         |                             | 46132                 |
| 30375Y         | 46133                       |                       |
| 30379R         |                             | 46132 + 43150 + 67050 |
| 30379Y         |                             | 46133 + 43150 + 67050 |
| 30503R         | 45062                       |                       |
| 30503Y         | 45063                       |                       |
| 3050A          | G3003                       |                       |
| 3058-3         | 47112-3                     |                       |
| 3058A          | 47113                       |                       |
| 3070A          |                             | G3003 + 43150         |
| 30740R         | 49142                       |                       |
| 3075A          | G3093                       |                       |
| 307A           | 77103                       |                       |
| 307B           | 77105                       |                       |
| 307R           | 77102                       |                       |
| 328d           | 73140-5                     |                       |
| 329d           | 73150-5                     |                       |
| 33010C         | 60721                       |                       |
| 33050R         | 49322                       |                       |
| 33050Y         | 49323                       |                       |
| 33075R         | 49332                       |                       |
| 33075Y         | 49333                       |                       |
| 33080R         | 49332                       |                       |
| 33080Y         | 49333                       |                       |
| 33208R         |                             | 49362 + 42292         |
| 33210C         | 60651                       |                       |
| 33250R         | 49332                       |                       |
| 33250Y         | 49333                       |                       |
| 33260Y         | 49323                       |                       |
| 35001R         | 65512                       |                       |
| 35001Y         | 65513                       |                       |
| 35080R         | 47242                       |                       |
| 35080Y         | 47243                       |                       |
| 35200R         | 47242                       |                       |
| 35200Y         | 47243                       |                       |
| 35375R         | 47462                       |                       |
| 35375Y         | 47463                       |                       |

| Truck-Lite® PN | Grote® Form, Fit & Function | Grote® Fit & Function |
|----------------|-----------------------------|-----------------------|
| 35740R         | 49122                       |                       |
| 35880R         | 47242                       |                       |
| 35880Y         | 47243                       |                       |
| 36041C         | 60781                       |                       |
| 36042C         | 60701                       |                       |
| 36115R         |                             | 47972                 |
| 36115Y         |                             | 47973                 |
| 36140C         | 60691                       |                       |
| 36203R         |                             | 49382                 |
| 36203Y         |                             | 49383                 |
| 3754D          | 50642                       |                       |
| 3756D          | 50642                       |                       |
| 3850AA         | 55223                       |                       |
| 40002R         | 52782                       |                       |
| 40002Y         |                             | 52773 + 91740 + 67000 |
| 40006R         |                             | 52770 + 91740 + 67000 |
| 40009R         |                             | 52152 + 67000 + 91740 |
| 40015R         |                             | 52672 + 67000 + 91740 |
| 40028R         | 52782                       |                       |
| 40042R         | 52782-3                     |                       |
| 40202R         | 52922                       |                       |
| 40202R3        | 52772-3                     |                       |
| 40202Y         | 52773                       |                       |
| 40206R         | 52770                       |                       |
| 40209R         | 52152                       |                       |
| 40215R         | 52672                       |                       |
| 40226R         |                             | 52672 + 92510         |
| 4023Y106       | 52902                       |                       |
| 40242R         | 52772                       |                       |
| 40242R3        | 52772-3                     |                       |
| 40242Y         | 52773                       |                       |
| 40248R         | 52672                       |                       |
| 4024Y106       | 52912                       |                       |
| 40282R         | 52922                       |                       |
| 40282Y         | 52923                       |                       |
| 40285R         | 52672-3                     |                       |
| 4051A          | G4023                       |                       |
| 4058-3         | 54342-3                     |                       |
| 4060C          | 62691                       |                       |
| 4091A          | 52063                       |                       |
| 4094A          |                             | 52063 + 66905         |
| 4095A          |                             | 53063 + 66905         |
| 41a            | 40233                       |                       |
| 433WD          | 60151                       |                       |
| 434WD          | 61501                       |                       |
| 43a            | 40193                       |                       |
| 44002R         |                             | 53253 + 66830         |
| 44022R         |                             | 53272 + 67002         |
| 44036R         |                             | 53292 + 67002         |
| 44092Y         |                             | 54313 + 92512         |
| 44093Y         |                             | 54313 + 92510         |
| 44094Y         |                             | 54313 + 91740         |
| 44095Y         |                             | 54313 + 92511         |
| 44101R         | 77352                       |                       |
| 44101Y         | 77353                       |                       |
| 44102R         |                             | 77352 + 91740 + 67002 |
| 44102Y         | 77353                       |                       |
| 44103R         | 77352                       |                       |
| 44103Y         | 77353                       |                       |
| 44104R         | 77352                       |                       |
| 44104Y         | 77353                       |                       |
| 44110Y         | 77353                       |                       |
| 44114Y         | 77353                       |                       |
| 44144Y         | 77353                       |                       |
| 44181C         |                             | 62101 + 92511 + 66862 |
| 44182C         |                             | 62101 + 92512 + 66862 |
| 44202R         | 53312                       |                       |

**TRUCK-LITE® -TO- GROTE®  
INTERCHANGE**

| Truck-Lite® PN | Grote® Form, Fit & Function | Grote® Fit & Function |
|----------------|-----------------------------|-----------------------|
| 44211R         | 77352                       |                       |
| 44211Y         | 77353                       |                       |
| 44212R         | 77352                       |                       |
| 44212Y         | 77353                       |                       |
| 44213R         | 77352                       |                       |
| 44213Y         | 77363                       |                       |
| 44214R         | 77352                       |                       |
| 44214Y         | 77353                       |                       |
| 44217Y         | 77353                       |                       |
| 44218Y         | 77353                       |                       |
| 44231Y         |                             | 53282 + 67002         |
| 44248Y         | 77353                       |                       |
| 44249Y         | 77353                       |                       |
| 44253R         |                             | 52092 + 67002         |
| 44291Y         |                             | 54313 + 92512         |
| 44292Y         |                             | 54313 + 92510         |
| 44293Y         |                             | 54313 + 91740         |
| 44294Y         | 54313                       |                       |
| 44295Y         |                             | 54313 + 92511         |
| 44302R         | 53552                       |                       |
| 44331R         | 53272                       |                       |
| 44344C         |                             | 62101 + 92511 + 66862 |
| 44345C         |                             | 62101 + 92510 + 66862 |
| 44346C         |                             | 62101 + 92512 + 66862 |
| 44348C         |                             | 62101 + 92512 + 66862 |
| 44349C         |                             | 62101 + 92510 + 66862 |
| 44350C         |                             | 62401 + 67013         |
| 44350R         | 53532                       |                       |
| 44355R         | 54332-3                     |                       |
| 44361R         | 54622                       |                       |
| 44438C         | 61171                       |                       |
| 44882R         | 53552                       |                       |
| 44982R         | 53552                       |                       |
| 44991C         |                             | 62101 + 92511         |
| 44992C         | 62791                       |                       |
| 45002R         |                             | 52203 + 94180 + 67090 |
| 45002Y         |                             | 52203 + 94180 + 67090 |
| 45051R         |                             | G4502 + 94180 + 67000 |
| 45201Y         | 52203                       |                       |
| 45202R         | 52202                       |                       |
| 45202Y         | 52203                       |                       |
| 45a            | 41003                       |                       |
| 49002R         | 53112                       |                       |
| 49003C         | 62121                       |                       |
| 49202R         | 53102                       |                       |
| 49203C         |                             | 62121 + 91740 + 67013 |
| 5015K          | 53722                       |                       |
| 5050DK         | 65320-5                     |                       |
| 5051DK         | 65330-5                     |                       |
| 50-60202R-3    | 52182-3                     |                       |
| 50-60202Y-3    | 52183-3                     |                       |
| 52a            | 41013                       |                       |
| 5315Y101       | 53762                       |                       |
| 533DK          | 65230-5                     |                       |
| 534D           | 52312-5                     |                       |
| 535D           | 52302-5                     |                       |
| 54a            | 41033                       |                       |
| 60002R         | 52572                       |                       |
| 60004C         | 62251                       |                       |
| 60015Y         | 52253                       |                       |
| 60050R         | 53122                       |                       |
| 60052R         |                             | 53592 + 66830         |

| Truck-Lite® PN | Grote® Form, Fit & Function | Grote® Fit & Function |
|----------------|-----------------------------|-----------------------|
| 60056R         |                             | 53622 + 66830         |
| 60072Y         |                             | 53593 + 66830         |
| 60075Y         | 53123                       |                       |
| 60083R         | 53092                       |                       |
| 60083Y         | 53093                       |                       |
| 60085R         | 53122                       |                       |
| 60115Y         |                             | 54183 + 66830 + 92420 |
| 60120R         | 77362                       |                       |
| 60120Y         | 77363                       |                       |
| 60122R         | 77362                       |                       |
| 60122Y         | 77363                       |                       |
| 60124R         | 77362                       |                       |
| 60124Y         | 77363                       |                       |
| 60126R         | 77362                       |                       |
| 60126Y         | 77363                       |                       |
| 60201R         | 52182                       |                       |
| 60201Y         | 52893                       |                       |
| 60202R         | 52182                       |                       |
| 60202Y         | 52183                       |                       |
| 60204C         | 62521                       |                       |
| 60215Y         | 52193                       |                       |
| 60250R         | 53962                       |                       |
| 60252R         | 53592                       |                       |
| 60256R         | 53622                       |                       |
| 60272Y         | 53593                       |                       |
| 60275Y         | 53963                       |                       |
| 60276Y         | 53623                       |                       |
| 60283R         | 52182                       |                       |
| 60283Y         | 52183                       |                       |
| 60315Y         | 54193                       |                       |
| 60317Y         | 54213                       |                       |
| 60360R         | 77362                       |                       |
| 60360Y         | 77363                       |                       |
| 60362R         | 77362                       |                       |
| 60362Y         | 77363                       |                       |
| 60364R         | 77362                       |                       |
| 60364Y         | 77363                       |                       |
| 60366R         | 77362                       |                       |
| 60366Y         | 77363                       |                       |
| 60420Y         | 54213                       |                       |
| 60421Y         | 54193                       |                       |
| 6050A          | G6003                       |                       |
| 6051A          | G6013                       |                       |
| 6053-3         | 53592-3                     |                       |
| 6053A          | 53593                       |                       |
| 6058-3         | G6002-3                     |                       |
| 6058A          | G6003                       |                       |
| 6058A-3        | G6003-3                     |                       |
| 6060C          | 62751                       |                       |
| 6063C3         | 62601-3                     |                       |
| 60872Y         | 53593                       |                       |
| 60885R         | 53962                       |                       |
| 60891Y         | 53963                       |                       |
| 612W           | 63531                       |                       |
| 620W           | 64101                       |                       |
| 620W4          | 64921                       |                       |
| 629W4          | 63181-5                     |                       |
| 630W           | 64931                       |                       |
| 630W4          | 64101                       |                       |
| 633W           | 64991                       |                       |
| 6503A          | 56073                       |                       |
| 6600A          | 78033                       |                       |
| 66050R         |                             | 53962 + 66830 + 92420 |
| 66052R         |                             | 53592 + 66830         |
| 66056R         |                             | 53622 + 66830         |
| 66206C         |                             | 62051 + 43222         |
| 66252R         | 53592                       |                       |
| 66256R         | 53622                       |                       |
| 6660PS         |                             | 77931                 |
| 66882R         | 53592                       |                       |
| 69202Y         | 52533                       |                       |

| Truck-Lite® PN | Grote® Form, Fit & Function | Grote® Fit & Function |
|----------------|-----------------------------|-----------------------|
| 70310R         | 50642                       |                       |
| 7044D          | 12014-5                     |                       |
| 7044DB         | 12014                       |                       |
| 7048D          | 12164-5                     |                       |
| 7048DB         | 12164                       |                       |
| 80162C         | 61991                       |                       |
| 80250C         | 61291                       |                       |
| 80251C         | 61E51                       |                       |
| 80251C3        | 61E61-3                     |                       |
| 80255C         | 61F61                       |                       |
| 80255C3        | 61F61-3                     |                       |
| 80302R         | 50222                       |                       |
| 80322R         |                             | 90013 + 50222         |
| 80324R         | 50532                       |                       |
| 80334R         | 50232                       |                       |
| 80335R         | 52522                       |                       |
| 80339R         | 50502                       |                       |
| 80423C         | 60311                       |                       |
| 80462R         | 50862                       |                       |
| 80463R         | 50852                       |                       |
| 81335C         | 64M11-5                     |                       |
| 8180-3         | 63G01                       |                       |
| 8370A          |                             | 77931                 |
| 8370B          |                             | 77931                 |
| 8370R          |                             | 77931                 |
| 8370W          |                             | 77931                 |
| 8861A          | 99913                       |                       |
| 8933A          | 90203                       |                       |
| 8938A          | 91503                       |                       |
| 9004A          | 90303                       |                       |
| 9005A          | 90053                       |                       |
| 9005W          | 90051                       |                       |
| 9006A          | 91963                       |                       |
| 9007A          | 91963                       |                       |
| 9007G          | 91964                       |                       |
| 9007W          | 91961                       |                       |
| 9016A          | 91583                       |                       |
| 9016W          | 91581                       |                       |
| 9021A          | 91583                       |                       |
| 9029A          | 90013                       |                       |
| 9029W          | 90011                       |                       |
| 90327R         | 50132                       |                       |
| 9040A          | 92173                       |                       |
| 9057A          | 91993                       |                       |
| 9063A          | 91503                       |                       |
| 9078A          | 91503                       |                       |
| 9079A          | 91503                       |                       |
| 9080A          | 91513                       |                       |
| 9093A          | 90123                       |                       |
| 9093W          | 90121                       |                       |
| 91241Y         | 55983                       |                       |
| 91242R         | 53422                       |                       |
| 91243Y         | 55993                       |                       |
| 91244R         | 53422                       |                       |
| 91315Y         | 54343                       |                       |
| 92525Y         | 76713                       |                       |
| 92530Y         | 77323                       |                       |
| 92531Y         | 77323                       |                       |
| 92534C         | 77101                       |                       |
| 92534Y         | 77103                       |                       |
| 92550Y         | 77353                       |                       |
| 92551Y         | 77363                       |                       |
| 92552Y         | 77353                       |                       |
| 92554Y         | 77013                       |                       |
| 92600Y         | 76223                       |                       |
| 92602Y         | 76033                       |                       |
| 92642Y         | 76983                       |                       |
| 92644Y         | 76993                       |                       |
| 92646Y         | 76993                       |                       |
| 92695R         | 77462                       |                       |
| 92695Y         | 77463                       |                       |
| 92696R         | 77462                       |                       |
| 92696Y         | 77463                       |                       |



## TRUCK-LITE®-TO-GROTE® INTERCHANGE

| Truck-Lite® PN | Grote® Form, Fit & Function | Grote® Fit & Function |
|----------------|-----------------------------|-----------------------|
| 92865Y         | 77813                       |                       |
| 92870B         | 77465                       |                       |
| 92870C         | 77461                       |                       |
| 92870R         | 77462                       |                       |
| 92870Y         | 77463                       |                       |
| 92WD           | 62021                       |                       |
| 9341A          | 90233                       |                       |
| 94902UB        | 67050                       |                       |
| 94902-UB       | 66850                       |                       |
| 94993UB        | 67090                       |                       |
| 98006r         | 40152                       |                       |
| 98006y         | 40153                       |                       |
| 98031r         | 41042                       |                       |
| 98031y         | 41043                       |                       |
| 98154r         | 41122                       |                       |
| 98175r         | 41142                       |                       |
| 98175y         | 41143                       |                       |
| 98176r         | 41152                       |                       |
| 98176y         | 41153                       |                       |
| 99007C         | 90761                       |                       |
| 99007R         | 90232                       |                       |
| 99007Y         | 90233                       |                       |
| 99008C         | 91311                       |                       |
| 99008R         | 90012                       |                       |
| 99008Y         | 90013                       |                       |
| 99009Y         | 90233                       |                       |
| 99039Y         | 90303                       |                       |
| 99041R         | 90152                       |                       |
| 99041Y         | 90153                       |                       |
| 99066Y         | 92773                       |                       |
| 99090Y         | 90233                       |                       |
| 99095C         | 90221                       |                       |
| 99167Y         | 90103                       |                       |
| 99168R         | 99842                       |                       |
| 99168Y         | 99843                       |                       |
| 99169R         | 99832                       |                       |
| 99169Y         | 99833                       |                       |
| 99170R         | 99802                       |                       |
| 99170Y         | 99803                       |                       |
| 99171R         | 99912                       |                       |
| 99171Y         | 99913                       |                       |
| TL00801        | 43690                       |                       |
| TL10202R       | 45812                       |                       |
| TL10202Y       | 45813                       |                       |
| TL10205R       | 45832                       |                       |
| TL10205Y       | 45833                       |                       |
| TL10212Y       | 78343                       |                       |
| TL10250R       | 47122                       |                       |
| TL10275Y       | 47233                       |                       |
| TL10279Y       | 47373                       |                       |
| TL10379R       | 47372                       |                       |
| TL10379Y       | 47373                       |                       |
| TL1050         | G1032                       |                       |
| TL1050A        | G1033                       |                       |
| TL10700        | 91410                       |                       |
| TL10708        | 92920                       |                       |
| TL10738        | 43690                       |                       |
| TL1075         | G1082                       |                       |
| TL1075A        | G1083                       |                       |
| TL1203         | 46782                       |                       |
| TL1211         | 46792                       |                       |
| TL1211A        | 46793                       |                       |
| TL15011        | 60280                       |                       |
| TL15200Y       | 46413                       |                       |
| TL15205        | 60421                       |                       |
| TL1560         | G1502                       |                       |
| TL1560A        | G1503                       |                       |
| TL15728        | 43380                       |                       |
| TL19200C       | 60301                       |                       |

| Truck-Lite® PN | Grote® Form, Fit & Function | Grote® Fit & Function |
|----------------|-----------------------------|-----------------------|
| TL19200R       | 46742                       |                       |
| TL19200Y       | 46743                       |                       |
| TL19205Y       | 78393                       |                       |
| TL19250Y       | G1903                       |                       |
| TL1960         | G1902                       |                       |
| TL1960A        | G1903                       |                       |
| TL19721        | 43850                       |                       |
| TL21002R       | 46082                       |                       |
| TL21002Y       | 46083                       |                       |
| TL21201R       | 46072                       |                       |
| TL21275Y       | 47163                       |                       |
| TL2150         | G2102                       |                       |
| TL2150A        | G2103                       |                       |
| TL22202Y       | 53063                       |                       |
| TL2660         | G4602                       |                       |
| TL2660A        | G4603                       |                       |
| TL2750         | G5300                       |                       |
| TL29203R       | 46872                       |                       |
| TL29203Y       | 46873                       |                       |
| TL30200R       | 45822                       |                       |
| TL30200Y       | 45823                       |                       |
| TL30230Y       | 78333                       |                       |
| TL30250R       | 47112                       |                       |
| TL30257Y       | 78333                       |                       |
| TL30375Y       | 46133                       |                       |
| TL30404        |                             | 93750 + 67050         |
| TL3050         | G3002                       |                       |
| TL3050A        | G3003                       |                       |
| TL3075A        | G3093                       |                       |
| TL33050R       | 49342                       |                       |
| TL33050Y       | 49343                       |                       |
| TL33075R       | 49332                       |                       |
| TL33203R       | 49362                       |                       |
| TL33250R       | 49332                       |                       |
| TL33250Y       | 49333                       |                       |
| TL35001R       | 65512                       |                       |
| TL35001Y       | 65513                       |                       |
| TL40002R       | 52782                       |                       |
| TL40202R       | 52772                       |                       |
| TL40282R       | 52922                       |                       |
| TL40282Y       | 52923                       |                       |
| TL4050         | G4002                       |                       |
| TL4050A        | G4003                       |                       |
| TL4051A        | G4022                       |                       |
| TL4060C        | 62691                       |                       |
| TL4095         | 66905                       |                       |
| TL44030R       | 53462                       |                       |
| TL44102Y       | 77353                       |                       |
| TL44211Y       | 77353                       |                       |
| TL44302R       | 53552                       |                       |
| TL44322R       | 53292                       |                       |
| TL44355R       | 54332-3                     |                       |
| TL45202R       | 52202                       |                       |
| TL45202Y       | 52203                       |                       |
| TL4550         | G4502                       |                       |
| TL60015Y       | 52253                       |                       |
| TL60050R       | 53122                       |                       |
| TL60120R       | 77362                       |                       |
| TL60120Y       | 77363                       |                       |
| TL60202R       | 52892                       |                       |
| TL60215Y       | 52193                       |                       |
| TL60250R       | 53962                       |                       |
| TL6050         | G6002                       |                       |
| TL69202Y       | 52533                       |                       |
| TL80251C       | 61E51                       |                       |
| TL80520        | 63531                       |                       |
| TL9049         | 91302                       |                       |
| TL9079A        | 91503                       |                       |
| TL9080A        | 91513                       |                       |
| TL92560        | 77013                       |                       |
| TL93745        | 66931                       |                       |
| TL94862        | 66930                       |                       |
| TL94897        | 66831                       |                       |

| Truck-Lite® PN | Grote® Form, Fit & Function | Grote® Fit & Function |
|----------------|-----------------------------|-----------------------|
| TL94902        | 67050                       |                       |
| TL94992        | 67010                       |                       |
| TL94993        | 67090                       |                       |
| TL96930        | 66360                       |                       |
| TL98006R       | 40152                       |                       |
| TL98006Y       | 40153                       |                       |
| TL98031Y       | 41043                       |                       |

## PETERSON®-TO-GROTE® INTERCHANGE

| Peterson® PN | Grote® Form, Fit & Function | Grote® Fit & Function |
|--------------|-----------------------------|-----------------------|
| 45           | 43424                       |                       |
| 294          | G6151                       |                       |
| 335          | 50630                       |                       |
| 367          | 61871                       |                       |
| 368          | 61861                       |                       |
| 400          | 60001                       |                       |
| 415          | 62271                       |                       |
| 425          | 50232                       |                       |
| 428          | 50852-3                     |                       |
| 435          | 60151                       |                       |
| 438          | 60101                       |                       |
| 445          | 50920                       |                       |
| 449          | 71422                       |                       |
| 454          | 50992                       |                       |
| 459          | 71152                       |                       |
| 500          | 48272                       |                       |
| 554          | 44810                       |                       |
| 557          | 44820                       |                       |
| 570          | 44530                       |                       |
| 571          | 44540                       |                       |
| 572          | 44891                       |                       |
| 573          | 44690                       |                       |
| 574          | 44700                       |                       |
| 576          | 44710                       |                       |
| 577          | 44720                       |                       |
| 598          | 18302-5                     |                       |
| 605          | 28032                       |                       |
| 608          | 12182                       |                       |
| 609          | 12071                       |                       |
| 615          | 16244                       |                       |
| 616          | 16092                       |                       |
| 654          | 28032                       |                       |
| 711          | 63821                       |                       |
| 780          | 73080                       |                       |
| 781          | 73080                       |                       |
| 782          | 73030                       |                       |
| 784          | 73030                       |                       |
| 785          | 73080                       |                       |
| 810          | 28323-5                     |                       |
| 821          | 28093-5                     |                       |
| 830          | 12243-5                     |                       |
| 832          | 12113-5                     |                       |
| 833          | 12263-5                     |                       |
| 836          | 12263-5                     |                       |
| 845          | G5202                       |                       |
| 2593         | 42180                       |                       |
| 2594         | 42180                       |                       |
| 4223         | G6013                       |                       |
| 4224         | G4002                       |                       |
| 4469         | 65513                       |                       |
| 4470         | 65512                       |                       |
| 5000         | 44030                       |                       |
| 5100         | 44010                       |                       |
| 5124         | 44010                       |                       |
| 100-15A      | 90163                       |                       |
| 100-15R      | 90162                       |                       |
| 107-15A      | 92433                       |                       |
| 107-15R      | 92432                       |                       |

**PETERSON®-TO-GROTE®  
INTERCHANGE**

| Peterson® PN | Grote® Form, Fit & Function | Grote® Fit & Function |
|--------------|-----------------------------|-----------------------|
| 107-3R       | 49112                       |                       |
| 107WA        | 46883                       |                       |
| 107WR        | 46882                       |                       |
| 108-15A      | 90203                       |                       |
| 108-15R      | 90202                       |                       |
| 108WA        | 46713                       |                       |
| 108WR        | 46712                       |                       |
| 110-15A      | 90303                       |                       |
| 110-15R      | 90302                       |                       |
| 118-15A      | 91683                       |                       |
| 119-15A      | 90053                       |                       |
| 119-15R      | 90052                       |                       |
| 119A         | 45173                       |                       |
| 119R         | 45172                       |                       |
| 1200R        | 47912                       |                       |
| 120-49       | 68380                       |                       |
| 1217R-9      | 53552                       |                       |
| 123A         | 46283                       |                       |
| 123R         | 46282                       |                       |
| 124-15A      | 90923                       |                       |
| 124-15R      | 90922                       |                       |
| 127-18       | 93402                       |                       |
| 127-181      | 93400                       |                       |
| 130-25A      | 91043                       |                       |
| 130-25R      | 91042                       |                       |
| 134-15A      | 90123                       |                       |
| 134-15R      | 90122                       |                       |
| 135A         | 45263                       |                       |
| 135R         | 45262                       |                       |
| 136-15A      | 90153                       |                       |
| 136-15R      | 90152                       |                       |
| 136-3R       | 49062                       |                       |
| 136A         | 45253                       |                       |
| 136R         | 45252                       |                       |
| 138-15A      | 91963                       |                       |
| 138-15R      | 91962                       |                       |
| 138A         | 46793                       |                       |
| 138R         | 46792                       |                       |
| 142-09       | 93750                       |                       |
| 142-18       | 91410                       |                       |
| 142-18K      | 94000                       |                       |
| 142-49       | 67050                       |                       |
| 142A         | 45813                       |                       |
| 142KA        | 45043                       |                       |
| 142KR        | 45042                       |                       |
| 142R         | 45812                       |                       |
| 143-092      | 43512                       |                       |
| 143-18       | 91400                       |                       |
| 143-18K      | 94010                       |                       |
| 143A         | 45833                       |                       |
| 143R         | 45832                       |                       |
| 144-18       | 92920                       |                       |
| 146-09       | 93760                       |                       |
| 146-092      | 43532                       |                       |
| 146-18       | 92120                       |                       |
| 146-182      | 92150                       |                       |
| 146A         | 45823                       |                       |
| 146R         | 45822                       |                       |
| 150-09       | 94233                       |                       |
| 150-091      | 42141                       |                       |
| 150-095      |                             | 94233                 |
| 150-10       | 94233                       |                       |
| 150-13       | 94233                       |                       |
| 150-14       | 43960                       |                       |
| 150-141      | 43962                       |                       |
| 150-3R       | 49172                       |                       |
| 150-49       | 66932                       |                       |
| 150A         | 46413                       |                       |
| 150C         | 60261                       |                       |

| Peterson® PN | Grote® Form, Fit & Function | Grote® Fit & Function |
|--------------|-----------------------------|-----------------------|
| 150R         | 46412                       |                       |
| 152-09       | 94233                       |                       |
| 152-091      | 94233                       |                       |
| 152-10       | 94233                       |                       |
| 152-49       | 67315                       |                       |
| 153-09       | 94233                       |                       |
| 153-49       | 67001                       |                       |
| 153A         | 47083                       |                       |
| 153C-142     |                             | 60671 + 43970         |
| 153C-143     |                             | 60671 + 94233         |
| 153C-BT2     | 60671                       |                       |
| 153R         | 47082                       |                       |
| 154-09K      | 43850                       |                       |
| 154-10K      |                             | 43783 + 66981         |
| 154A         | 46743                       |                       |
| 154C         | 60291                       |                       |
| 154KA        | 45093                       |                       |
| 154KR        | 45092                       |                       |
| 154R         | 46742                       |                       |
| 155R         | 46832                       |                       |
| 160-09       | 43120                       |                       |
| 160-49       | 66930                       |                       |
| 160-491      | 66930                       |                       |
| 160-493      | 66932                       |                       |
| 161A         | 47093                       |                       |
| 161KA        | 65203                       |                       |
| 161R         | 47092                       |                       |
| 162-49       | 67001                       |                       |
| 162-493      | 66851                       |                       |
| 162A         | 47123                       |                       |
| 162R         | 47122                       |                       |
| 162Y         | G1033                       |                       |
| 163A         | G1033                       |                       |
| 163FA        |                             | G1033 + 42170         |
| 163FR        |                             | G1032 + 42170         |
| 163KA        |                             | G1033 + 91400 + 67001 |
| 163KR        |                             | G1032 + 91400 + 67001 |
| 163R         | G1032                       |                       |
| 164A         | 47113                       |                       |
| 164R         | 47112                       |                       |
| 165-10       | 43690                       |                       |
| 165R         | G3002                       |                       |
| 166A         | G3093                       |                       |
| 166R         | G3092                       |                       |
| 168R         | 45002-5                     |                       |
| 173A         | G1003                       |                       |
| 173R         | G1002                       |                       |
| 174A         | 47113                       |                       |
| 176-10       | 42110                       |                       |
| 176-11       | 42292                       |                       |
| 176-12       | 42282                       |                       |
| 176-14       | 42302                       |                       |
| 176-16       | 42312                       |                       |
| 176A-BT2     | 49333                       |                       |
| 176BKA       |                             | 49333 + 42110         |
| 176BKR       |                             | 49332 + 42110         |
| 176R-BT2     | 49332                       |                       |
| 188A         | G2103                       |                       |
| 188R         | G2102                       |                       |
| 192-492      | 66862                       |                       |
| 19-41        | 44421                       |                       |
| 196A         | 47123                       |                       |
| 196R         | 47122                       |                       |
| 198A         | 47113                       |                       |
| 198R         | 47112                       |                       |
| 2636A        |                             | 46413 + 91380 + 67050 |
| 2636R        |                             | 46412 + 91380 + 67050 |
| 290C         | 60701                       |                       |
| 313-2        | 53052                       |                       |

| Peterson® PN | Grote® Form, Fit & Function | Grote® Fit & Function |
|--------------|-----------------------------|-----------------------|
| 313-2RA      | 53000                       |                       |
| 313AA        | 53023                       |                       |
| 318L         |                             | 56160-5 + 56180-5     |
| 318L-P       |                             | 56160-5 + 56180-5     |
| 318R         |                             | 56160-5 + 56180-5     |
| 318R-P       |                             | 56160-5 + 56180-5     |
| 319AA        | 56150                       |                       |
| 319R         | 56180-5                     |                       |
| 319R-P       | 56180-5                     |                       |
| 326-2        | 55470                       |                       |
| 344-49       | 66861                       |                       |
| 352A         | 52193                       |                       |
| 410-21       | 99595                       |                       |
| 411-07       | 68170                       |                       |
| 413-07       | 68130                       |                       |
| 414-15C      | 91311                       |                       |
| 415K         | 62221                       |                       |
| 417-2        | 43642                       |                       |
| 417-48       | 66862                       |                       |
| 417-481      | 66860                       |                       |
| 417-49       | 66861                       |                       |
| 417-491      | 66860                       |                       |
| 417-491MP    | 67006                       |                       |
| 417-493      | 67006                       |                       |
| 418R-3P      |                             | 54572 + 66861         |
| 420C-5P      |                             | 62561 + 66842         |
| 420KR-5      |                             | 53962 + 92420 + 66830 |
| 420R-5P      |                             | 53962 + 66830         |
| 421-09       | 43362                       |                       |
| 421-19       | 67014                       |                       |
| 421-49       | 67014                       |                       |
| 421-491      | 67090                       |                       |
| 421-491Y     | 66810                       |                       |
| 421A         | 52183                       |                       |
| 421KR        | 52572                       |                       |
| 421R         | 52182                       |                       |
| 423C-5P      |                             | 62561 + 43222 + 66842 |
| 423R-5       | 53622                       |                       |
| 423R-5P      |                             | 53622 + 66830         |
| 424-09       | 92512                       |                       |
| 426-09       | 43572                       |                       |
| 426-10       | 43655                       |                       |
| 426A         | 52923                       |                       |
| 426KR        | 52782                       |                       |
| 426R         | 52922                       |                       |
| 431-49       | 67010                       |                       |
| 431-491      | 67000                       |                       |
| 431A         | 52773                       |                       |
| 431KR        | 53012                       |                       |
| 431R         | 52922                       |                       |
| 436-01       | 93610                       |                       |
| 440-15       | 92792                       |                       |
| 440L         | 52312                       |                       |
| 445-25       | 91302                       |                       |
| 4523-49      | 66870                       |                       |
| 464-1        | 41050                       |                       |
| 464-2        | 41050                       |                       |
| 465-1        | 41160                       |                       |
| 465-2        | 41160                       |                       |
| 465-4K       | 40650-5                     |                       |
| 465K         | 40650-5                     |                       |
| 467-1        | 40641                       |                       |
| 467-4K       | 40641-5                     |                       |
| 469-1        | 41133                       |                       |
| 505K         | 64261-4                     |                       |
| 510-9        | 43112                       |                       |
| 55-15A       | 91113                       |                       |
| 55-15R       | 91112                       |                       |

**PETERSON®-TO-GROTE®  
 INTERCHANGE**

| Peterson® PN | Grote® Form, Fit & Function | Grote® Fit & Function |
|--------------|-----------------------------|-----------------------|
| 608X         |                             |                       |
| 608XO        | 12183                       |                       |
| 616W         | 12293                       |                       |
| 617X         | 16091                       |                       |
| 654X         | 16023                       |                       |
| 658X         | 28033-5                     |                       |
| 667X         | 12272-5                     |                       |
| 672X         | 26012-5                     |                       |
| 701C         | 28493                       |                       |
| 702C         | 90941-5                     |                       |
| 703C         | 94421-5                     |                       |
| 717A         | 94411-5                     |                       |
| 717R         | 55993                       |                       |
| 786-102      | 55982                       |                       |
| 786-97       | 73160                       |                       |
| 786-97       | 73220                       |                       |
| 817KCR-3     |                             | 01-5325-83 + 67006    |
| 817KR-3      |                             | 53552 + 91740 + 67006 |
| 817R-36      | 54562                       |                       |
| 817R-7       | 53552                       |                       |
| 817TA-2      | 54363                       |                       |
| 818KR-3      |                             | 53292 + 91740 + 67006 |
| 818R-2       |                             | 53292 + 67006         |
| 818R-3       |                             | 53292 + 67006         |
| 820R-10      | 54142                       |                       |
| 820R-2       |                             | 53962 + 67006         |
| 821A-10      | G6003                       |                       |
| 821A-7       | G6003                       |                       |
| 821R-7       | G6002                       |                       |
| 822R-3       |                             | G6002 + 43222         |
| 824R-3       |                             | G4002 + 92512         |
| 826A-7       | G4003                       |                       |
| 826C-7       | 62691                       |                       |
| 826R         | 54342                       |                       |
| 826R-7       | G4002                       |                       |
| 826R-9       | G4002                       |                       |
| 845L         | G5212                       |                       |
| 850R-1       |                             | G4502 + 67000         |
| 850R-1P      |                             | G4502 + 67000         |
| 909-MV       | 63981                       |                       |
| 911-MV       | 63861                       |                       |
| 912-MV       | BZ111-5                     |                       |
| 917-MV       | 63F51                       |                       |
| B107-15A     | 92433                       |                       |
| B107-15R     | 92432                       |                       |
| B1200-09X    | 93453                       |                       |
| B127-18      | 94180                       |                       |
| B134-15A     | 90123                       |                       |
| B134-15R     | 90122                       |                       |
| B138-15C     | 91961                       |                       |
| B142-49      | 67050                       |                       |
| B142-50      | 67001                       |                       |
| B142-51      | 67001                       |                       |
| B146-09      | 93760                       |                       |
| B146-093     | 93760                       |                       |
| B146-182     | 92150                       |                       |
| B146-49      | 66932                       |                       |
| B150-095     |                             | 94233                 |
| B150-141     | 43962                       |                       |
| B150-141B    | 43262-3                     |                       |
| B150-142     | 43962                       |                       |
| B150-143     | 43962                       |                       |
| B150-18      | 91380                       |                       |
| B150-181     | 91380                       |                       |
| B150-491     | 67120                       |                       |
| B152-49      | 67400                       |                       |
| B153-49      | 66981                       |                       |
| B153-492     | 66981                       |                       |

| Peterson® PN | Grote® Form, Fit & Function | Grote® Fit & Function |
|--------------|-----------------------------|-----------------------|
| B153-493     | 66982                       |                       |
| B154-092     | 43230                       |                       |
| B154-11      | 43780                       |                       |
| B154-11K     | 43780                       |                       |
| B160-49      | 66930                       |                       |
| B160-491     | 66930                       |                       |
| B160-492     | 66931                       |                       |
| B162-49      | 67001-3                     |                       |
| B162-493     | 66851                       |                       |
| B167-09      | 43780                       |                       |
| B167-49      | 66981                       |                       |
| B167-491     | 43780                       |                       |
| B167-492     | 66801                       |                       |
| B168-092     | 43120                       |                       |
| B168-092B    | 43120                       |                       |
| B168-093     | 43780                       |                       |
| B168-181     | 43120                       |                       |
| B177-18      | 60-1084-03                  |                       |
| B193-492     | 66826                       |                       |
| B2412        | 66932                       |                       |
| B2712        | 66932                       |                       |
| B388-09X     | 93453                       |                       |
| B411-07      | 68170                       |                       |
| B413-07      | 68130                       |                       |
| B417-49      | 66861                       |                       |
| B417-491     | 66860                       |                       |
| B417-496     | 66860                       |                       |
| B418-10      | 92513                       |                       |
| B421-18      | 92420-3                     |                       |
| B421-19      | 67014                       |                       |
| B421-49      | 67014                       |                       |
| B421-491     | 67090                       |                       |
| B426-18      | 91740-3                     |                       |
| B431-491     | 67000                       |                       |
| B450-18      | 94180-3                     |                       |
| B460A        | 40193                       |                       |
| B460R        | 40192                       |                       |
| B474A        | 40073                       |                       |
| B474R        | 40072                       |                       |
| B476A        | 40153                       |                       |
| B476R        | 40152                       |                       |
| B477A        | 40093                       |                       |
| B477R        | 40092                       |                       |
| B479A        | 41043                       |                       |
| B479R        | 41042                       |                       |
| B481A        | 40073                       |                       |
| B481R        | 40072                       |                       |
| B484A        | 40303                       |                       |
| B484R        | 40302                       |                       |
| B485A        | 40303                       |                       |
| B485R        | 40302                       |                       |
| B489A        | 40303                       |                       |
| B489R        | 40302                       |                       |
| B492A        | 40133                       |                       |
| B492R        | 40132                       |                       |
| B5425Y       | 68420                       |                       |
| B570         | 44540                       |                       |
| B7005S       | 43153                       |                       |
| B7007S       | 43823                       |                       |
| B817-48      | 68580                       |                       |
| B850-18      | 94180-3                     |                       |
| M102A        | 45413-3                     |                       |
| M106A        | 45933-3                     |                       |
| M112A        | 46393                       |                       |
| M114R        | 46982-5                     |                       |
| M120A        | 99913                       |                       |
| M120R        | 99912                       |                       |
| M122XA       | 46893                       |                       |
| M122XR       | 46892                       |                       |
| M125A        | 47053                       |                       |
| M125R        | 47052                       |                       |
| M126A        | 47053                       |                       |
| M126R        | 47052                       |                       |

| Peterson® PN | Grote® Form, Fit & Function | Grote® Fit & Function |
|--------------|-----------------------------|-----------------------|
| M127A        | 45233                       |                       |
| M127R        | 45232                       |                       |
| M130A        | 46303-3                     |                       |
| M130R        | 46302-3                     |                       |
| M135A        | 45263-3                     |                       |
| M135R        | 45262-3                     |                       |
| M136A        | 45253-3                     |                       |
| M138C        | 46791                       |                       |
| M146C        | 45821                       |                       |
| M150W        | 60271                       |                       |
| M153C-BT2    | 60671-3                     |                       |
| M154C        | 60291-3                     |                       |
| M160A        | 47463-3                     |                       |
| M160R        | 47242-3                     |                       |
| M162R        | 47122-3                     |                       |
| M164A        | G3003-3                     |                       |
| M164R        | G3002-3                     |                       |
| M171C        | 49341-3                     |                       |
| M181A-BT2    | 49333-3                     |                       |
| M181R-BT2    | 49332-3                     |                       |
| M196R        | 47122-3                     |                       |
| M196Y        | G1033-3                     |                       |
| M197A        | 47233-3                     |                       |
| M198A        | G3003-3                     |                       |
| M198R        | G3002-3                     |                       |
| M2875AF-P    | 53623                       |                       |
| M290C        | 60381-3                     |                       |
| M294         | G6151                       |                       |
| M360         | 61261                       |                       |
| M360-BT2     | 61261                       |                       |
| M365         | 61F61-3                     |                       |
| M367         | 61871-3                     |                       |
| M393C        | 62291                       |                       |
| M400         | 60001-3                     |                       |
| M411SC       | 62151                       |                       |
| M417R        | 53532                       |                       |
| M418R        | 53182                       |                       |
| M420C-5      |                             | 62561 + 66842         |
| M420C-5AMP   |                             | 62561 + 67006         |
| M420C-5P     |                             | 62561 + 66831         |
| M420C-5PKD   |                             | 62561 + 67006         |
| M420R-P      | G6002-3                     |                       |
| M421R        | 52892-3                     |                       |
| M423C-5AMP   |                             | 62561 + 43222 + 67006 |
| M423C-5P     |                             | 62561 + 43222 + 66831 |
| M423TA-2AMP  |                             | 53623 + 66815         |
| M423VC-1P    |                             | 62751 + 43222         |
| M426R        | 52772-3                     |                       |
| M431KC       | 62221                       |                       |
| M431KR       | 52782-3                     |                       |
| M431R        | 52772-3                     |                       |
| M434         | 61501                       |                       |
| M435         | 60151                       |                       |
| M436B        | 60081                       |                       |
| M507         | 64931                       |                       |
| M525         | 63531                       |                       |
| M821A-10     | G6003-3                     |                       |
| M821A-7      | G6003-3                     |                       |
| M821R-7      | G6002-3                     |                       |
| M826C-7      | 62691-3                     |                       |
| M826R        | 54342-3                     |                       |
| M826R-7      | G4002-3                     |                       |
| M826R-9      | G4002-3                     |                       |
| PM-ECK-T     | 99170                       |                       |
| PMV0099PT    | 99580                       |                       |
| V106-09      | 43673                       |                       |
| V114A        | 46983-5                     |                       |
| V126A        | 47053                       |                       |
| V143R        | 45832                       |                       |
| V153KC-MV    |                             | 60671 + 43970         |
| V171C        | 49341                       |                       |

**PETERSON®-TO-GROTE®  
INTERCHANGE**

| Peterson® PN | Grote® Form, Fit & Function | Grote® Fit & Function |
|--------------|-----------------------------|-----------------------|
| V25900-09    | 43272                       |                       |
| V294         | G6151                       |                       |
| V313-2RA     | 55280                       |                       |
| V369S        | 60591                       |                       |
| V379S        | 61171                       |                       |
| V421R        | 52182-5                     |                       |
| V423XR-4     | 52592-5                     |                       |
| V426R        | 52922-5                     |                       |
| V428         | 50852                       |                       |
| V428S        | 50862                       |                       |
| V434         | 61501-5                     |                       |
| V437         | 60251                       |                       |
| V440L        | 52312-5                     |                       |
| V456         | 52482                       |                       |
| V456L        | 52492                       |                       |
| V472A        | 40233                       |                       |
| V472R        | 40232                       |                       |
| V475A        | 40063                       |                       |
| V475R        | 40062                       |                       |
| V480A        | 41033                       |                       |
| V480R        | 41032                       |                       |
| V483A        | 40303                       |                       |
| V483R        | 40302                       |                       |
| V487A        | 40133                       |                       |
| V487R        | 40132                       |                       |
| V490A        | 40053                       |                       |
| V490R        | 40052                       |                       |
| V500         | 48272                       |                       |
| V520-40      | 44840-5                     |                       |
| V5325        | 68540                       |                       |
| V540         | 65370-5                     |                       |
| V5425Y       | 68420                       |                       |
| V570         | 44530                       |                       |
| V582-2       | 64371-5                     |                       |
| V599         | 12312-5                     |                       |
| V600         | 12201-5                     |                       |
| V602         | 12164                       |                       |
| V603         | 12004-5                     |                       |
| V603B        | 12004                       |                       |
| V603L        | 12014                       |                       |
| V604         | 12312-5                     |                       |
| V7004        | 43153                       |                       |
| V7005        | 43153                       |                       |
| V7007        | 43163                       |                       |
| V7009        | 92513                       |                       |
| V7010        | 42153                       |                       |
| V7011        | 42153                       |                       |
| V780         | 73080                       |                       |
| V781         | 73080                       |                       |
| V783         | 73080                       |                       |
| V845         | G5082-5                     |                       |
| V904-MV      | BZ601-5                     |                       |
| V910-MV      | BZ201-5                     |                       |
| V911-MV      | BZ101-5                     |                       |
| V940         | 65330-5                     |                       |

**PRIMATRONICS®-TO-GROTE®  
INTERCHANGE**

| Primatronics® PN | Grote® Form, Fit & Function | Grote® Fit & Function |
|------------------|-----------------------------|-----------------------|
| PT1000A          | 45813                       |                       |
| PT1000A-ABS      | 78343                       |                       |
| PT1000BK         | 43512                       |                       |
| PT1000G          | 91410                       |                       |
| PT1000GK         | 94010                       |                       |
| PT1000R          | 45812                       |                       |
| PT1000R-Kit      | 45042                       |                       |
| PT1000W          | 45811                       |                       |
| PT1001BK         | 42180                       |                       |
| PT1002BK         |                             | 43690                 |
| PT1002G          | 91400                       |                       |
| PT1003BK         |                             | 42180 + 67050         |
| PT1004G          | 91410                       |                       |
| PT100A-Kit       | 45043                       |                       |
| PT1050R          | 49142                       |                       |
| PT1100A          | 45833                       |                       |
| PT1100R          | 45832                       |                       |
| PT1300A          | 45333                       |                       |
| PT1500A          | 46413                       |                       |
| PT1500BK         |                             | 42131                 |
| PT1500L          | 60261                       |                       |
| PT1500R          | 46412                       |                       |
| PT1500W          | 60271                       |                       |
| PT1550R          | 49172                       |                       |
| PT1900A          | 46743                       |                       |
| PT1900BK         | 43850                       |                       |
| PT1900L          | 60291                       |                       |
| PT1900R          | 46742                       |                       |
| PT1900W          | 60301                       |                       |
| PT2100A          | 46083                       |                       |
| PT2100R          | 46082                       |                       |
| PT2102A          | 46873                       |                       |
| PT2102R          | 46872                       |                       |
| PT2110C          | 60331                       |                       |
| PT2200A          | 53063                       |                       |
| PT2200R          | 53062                       |                       |
| PT2601A          | 45263                       |                       |
| PT2601R          | 45262                       |                       |
| PT2602A          | 46793                       |                       |
| PT2602R          | 46792                       |                       |
| PT2603A          | 45933                       |                       |
| PT2603R          | 45932                       |                       |
| PT2605A          | 46893                       |                       |
| PT2605R          | 46892                       |                       |
| PT2610A          |                             | 45233                 |
| PT2610R          |                             | 45232                 |
| PT2615A          | 46783                       |                       |
| PT2615R          | 46782                       |                       |
| PT2630A          | 45253                       |                       |
| PT2630R          | 45252                       |                       |
| PT2640A          | 46883                       |                       |
| PT2640R          | 46882                       |                       |
| PT2650A          | 46893-5                     |                       |
| PT2650R          | 46892-5                     |                       |
| PT2660R          | 49112                       |                       |
| PT2700L          | 60151                       |                       |
| PT2701L          | 42162                       |                       |
| PT2702L          | 43960                       |                       |
| PT2703L          | 60460                       |                       |
| PT2704L          | 60101                       |                       |
| PT3000A          | 45823                       |                       |
| PT3000A-AB S     | 78333                       |                       |
| PT3000A-Kit      | 45063                       |                       |
| PT3000AS         |                             | 45813 + 42180         |
| PT3000BK         | 43532                       |                       |
| PT3000G          | 92120                       |                       |
| PT3000GK         | 94100                       |                       |
| PT3000R          | 45822                       |                       |
| PT3000R-Kit      | 45062                       |                       |
| PT3000RS         |                             | 45812 + 42180         |

| Primatronics® PN | Grote® Form, Fit & Function | Grote® Fit & Function |
|------------------|-----------------------------|-----------------------|
| PT3000W          | 45821                       |                       |
| PT3300A          | 47103                       |                       |
| PT3300R          | 47102                       |                       |
| PT4000A          | 52923                       |                       |
| PT4000BK         | 43572                       |                       |
| PT4000G          | 91740                       |                       |
| PT4000MA         | 53103                       |                       |
| PT4000MR         | 53102                       |                       |
| PT4000R          | 52922                       |                       |
| PT4000R-Kit      | 53012                       |                       |
| PT4000W          | 62271                       |                       |
| PT4002G          | 91950                       |                       |
| PT4100R          | 52672                       |                       |
| PT4200BK         | 51090                       |                       |
| PT4200L          | 51032                       |                       |
| PT4200R          | 51022                       |                       |
| PT4200U          | 51052                       |                       |
| PT4212RF         | 50232                       |                       |
| PT4212RF-LN      | 90012                       |                       |
| PT4500A          | 52203                       |                       |
| PT4500BK         | 43212                       |                       |
| PT4500G          | 94180                       |                       |
| PT4500R          | 52202                       |                       |
| PT4706P          | 66860                       |                       |
| PT4707P          | 68580                       |                       |
| PT4902P          |                             | 67050                 |
| PT4924P          | 67050                       |                       |
| PT4925P          | 67010                       |                       |
| PT4926P          | 67000                       |                       |
| PT4992P          | 67014                       |                       |
| PT4993P          | 67090                       |                       |
| PT4999P          | 67010                       |                       |
| PT5001A          |                             | 77473                 |
| PT5001A-FT       |                             | 92980                 |
| PT5001A-LN       |                             | 92033                 |
| PT5005A          | 77013                       |                       |
| PT5005A-FT       | 92960                       |                       |
| PT5110           |                             | 73040                 |
| PT5175           |                             | 73250                 |
| PT5199           |                             | 73030                 |
| PT5315A-FT       | 90900                       |                       |
| PT5412           |                             | 44810                 |
| PT5413           |                             | 44820                 |
| PT5453           |                             | 44530                 |
| PT5454           |                             | 44540                 |
| PT5469           |                             | 44690                 |
| PT5471           |                             | 44710                 |
| PT5481           |                             | 44720                 |
| PT6000A          | 52183                       |                       |
| PT6000BK         | 43362                       |                       |
| PT6000G          | 92420                       |                       |
| PT6000R          | 52182                       |                       |
| PT6000R-Kit      | 53092                       |                       |
| PT6000W          | 62521                       |                       |
| PT6002G          | 92720                       |                       |
| PT6106P          | 67013                       |                       |
| PT6107P          | 67002                       |                       |
| PT6500A          | 52193                       |                       |
| PT8005           | 61821                       |                       |
| PT8010           | 91302                       |                       |
| PT8020           | 52442                       |                       |
| PT8021           | 52452                       |                       |
| PT8428           | 50872                       |                       |
| PT8428S          | 50892                       |                       |
| PT8428W          | 50882                       |                       |
| PT8620           | 53000                       |                       |
| PT9805A          | 40053                       |                       |
| PT9805R          | 40052                       |                       |
| PT9806A          | 40153                       |                       |
| PT9806R          | 40152                       |                       |
| PT9807A          | 40093                       |                       |
| PT9807R          | 40092                       |                       |
| PT9808A          | 40073                       |                       |

**PRIMATRONICS®-TO-GROTE®  
INTERCHANGE**

| Primatronics® PN | Grote® Form, Fit & Function | Grote® Fit & Function |
|------------------|-----------------------------|-----------------------|
| PT9808R          | 40072                       |                       |
| PT9832A          | 41033                       |                       |
| PT9832R          | 41032                       |                       |
| PTL1004A         |                             | G1033                 |
| PTL1004R         |                             | G1032                 |
| PTL1013A         |                             | G1033                 |
| PTL1013R         |                             | G1032                 |
| PTL1108A         | G1003                       |                       |
| PTL1108R         | G1002                       |                       |
| PTL1313A         |                             | G1083                 |
| PTL1313R         |                             | G1082                 |
| PTL1503A         | G1503                       |                       |
| PTL1503R         | G1502                       |                       |
| PTL1508W         | 60421                       |                       |
| PTL1550R         | 49182                       |                       |
| PTL1912A         | G1903                       |                       |
| PTL1912R         | G1902                       |                       |
| PTL1912W         | 60301                       |                       |
| PTL2002C         |                             | G6151                 |
| PTL3004A         |                             | G3003                 |
| PTL3004R         |                             | G3002                 |
| PTL3009A         | G3003                       |                       |
| PTL3009R         | G3002                       |                       |
| PTL3309A         | G3093                       |                       |
| PTL3309R         | G3092                       |                       |
| PTL3507A         |                             | 47243                 |
| PTL3507R         |                             | 47242                 |
| PTL3606A         |                             | 47243                 |
| PTL3606R         |                             | 47242                 |
| PTL4010A         |                             | G4003                 |
| PTL4010R         |                             | G4002                 |
| PTL4018A         |                             | G4003                 |
| PTL4018R         |                             | G4002                 |
| PTL4019W         |                             | 62691                 |
| PTL4040A         |                             | G4003                 |
| PTL4040AF        |                             | G4003 + 92512         |
| PTL4040R         |                             | G4002                 |
| PTL4040RF        |                             | G4002 + 92512         |
| PTL4040W         |                             | 62691                 |
| PTL4048A         |                             | G4003                 |
| PTL4048R         |                             | G4002                 |
| PTL5020          |                             | 63611                 |
| PTL5021          | 64931                       |                       |
| PTL5030          |                             | 63G11                 |
| PTL5040          |                             | 63G01                 |
| PTL5313A         |                             | G4603                 |
| PTL5313R         |                             | G4602                 |
| PTL5505A         |                             | 45583                 |
| PTL5915A         |                             | 47253                 |
| PTL6010A         |                             | G6003                 |
| PTL6010R         |                             | G6002                 |
| PTL6027W         |                             | 62751                 |
| PTL6056A         | G6003                       |                       |
| PTL6056R         | G6002                       |                       |
| PTL8000          |                             | G5082                 |
| PTL8001          |                             | G5092                 |
| PTL8020          |                             | 53662                 |
| PTL8020K         |                             | 65230-5               |
| PTL8021          |                             | 53672                 |
| PTL8620          |                             | G5300                 |
| PTM0105          | 12164                       |                       |
| PTM09109         | 12312-5                     |                       |
| PTM9102          | 12201-5                     |                       |
| PTM9103          | 12004                       |                       |
| PTM9104          | 12014                       |                       |
| PTM9205FB        | 28152                       |                       |
| PTM9205K         | 28033                       |                       |
| PTM9205WK        | 28031                       |                       |
| PTM9206          | 28663                       |                       |

| Primatronics® PN | Grote® Form, Fit & Function | Grote® Fit & Function |
|------------------|-----------------------------|-----------------------|
| PTM9206B         |                             | 12052 + 11303         |
| PTM9206BK        |                             | 28042                 |
| PTM9206K         | 28043                       |                       |
| PTM9206WK        | 28041                       |                       |
| PTM9209          | 16033                       |                       |
| PTM9209B         | 16032                       |                       |
| PTM9209H         |                             | 12283 + 11303         |
| PTM9210          | 12010                       |                       |
| PTM9217          |                             | 12293                 |
| PTM9217B         |                             | 12182 + 11303         |
| PTM9217H         |                             | 12283 + 11303         |
| PTM9219          |                             | 12173 + 11303         |
| PTM9219B         |                             | 12172 + 11303         |
| PTM9219H         |                             | 12283 + 11303         |
| PTM9248          |                             | 28763                 |
| PTM9300A         | 16244                       |                       |
| PTM9310          |                             | 16023                 |
| PTM9310H         | 16053                       |                       |
| PTM9310HL        | 16173                       |                       |
| PTM9320          | 16123                       |                       |
| PTM9320CV        | 16043                       |                       |
| PTM9320H-L       | 16223                       |                       |
| PTM9330          | 16273                       |                       |
| PTM9330B         | 16142                       |                       |
| PTM9340          | 16023                       |                       |
| PTM9340H         |                             | 16053                 |
| PTM9340HL        |                             | 16223                 |
| PTM9350          | 16093                       |                       |
| PTM9350B         | 16092                       |                       |
| PTM9350W         | 16091                       |                       |
| PTM9360B         | 16102                       |                       |
| PTM9360W         | 16101                       |                       |
| PTM9370          | 16284                       |                       |
| PTM9420          |                             | 28453                 |
| PTM9460          | 28093-5                     |                       |
| PTM9706          | 28323-5                     |                       |
| PTM9710S         | 22013                       |                       |
| PTM9712          | 10173                       |                       |
| PTM9714          | 11303                       |                       |
| PTM9716          | 11133                       |                       |
| PTM9717          | 10073                       |                       |
| PTM9718          | 10173                       |                       |
| PTM9720          | 10623                       |                       |
| PTM9724          |                             | 10013                 |
| PTM9726          |                             | 10025                 |
| PTM9730          |                             | 10045                 |
| PTM9800          | 22193                       |                       |
| PTM9809          | 28443                       |                       |
| PTM9810          | 28493                       |                       |
| PTM9830          | 12153                       |                       |
| PTM9840          | 10433                       |                       |
| PTM9900          | 29060                       |                       |

**MAXXIMA®-TO-GROTE®  
INTERCHANGE**

| Maxxima® PN | Grote® Form, Fit & Function | Grote® Fit & Function |
|-------------|-----------------------------|-----------------------|
| 431-491     | 67000-3                     |                       |
| B431-491    | 67000-3                     |                       |
| M09100R     | G3002                       |                       |
| M09100WCL   |                             | 60561                 |
| M09100Y     | G3003                       |                       |
| M09105R     | G3092                       |                       |
| M09105Y     | G3093                       |                       |
| M09250R-X   | G3002-3                     |                       |
| M09250Y-X   | G3003-3                     |                       |
| M09300R     |                             | 49332                 |
| M09300R-X   |                             | 49332-3               |
| M09300WCL   |                             | 49341                 |
| M09300Y     |                             | 49333                 |

| Maxxima® PN  | Grote® Form, Fit & Function | Grote® Fit & Function |
|--------------|-----------------------------|-----------------------|
| M09300YAT    |                             | 49323                 |
| M09320R      | 49332                       |                       |
| M09320R-X    |                             | 49322-3               |
| M09320Y      | 49333                       |                       |
| M09320Y-X    |                             | 49323-3               |
| M09370WCL    |                             | 77931 + 97942         |
| M09370WCL-NS |                             | 60651                 |
| M09370Y      |                             | 77933 + 97942         |
| M09370YCL    |                             | 77933 + 97942         |
| M09410WCL    |                             | 49341                 |
| M11201R      | G1082                       |                       |
| M11201Y      | G1083                       |                       |
| M11256R      | G1002                       |                       |
| M11256Y      | G1003                       |                       |
| M11260R      | 47232                       |                       |
| M11260Y      | 47233                       |                       |
| M11300R      | G1032                       |                       |
| M11300RCL    | G1042                       |                       |
| M11300Y      | G1033                       |                       |
| M11300YCL    | G1043                       |                       |
| M11350RCL-X  | G1042                       |                       |
| M11350R-X    | G1032-3                     |                       |
| M11350YCL-X  | G1043                       |                       |
| M11350Y-X    | G1033                       |                       |
| M16280R      | G1032                       |                       |
| M16280Y      | G1033                       |                       |
| M16280Y-X    |                             | G1092-3               |
| M16800R      |                             | G1082                 |
| M16800Y      |                             | G1083                 |
| M20311R      | G5052                       |                       |
| M20311Y      | G5053                       |                       |
| M20320R      | G1502                       |                       |
| M20320Y      | G1503                       |                       |
| M20321R      |                             | G1502 + 43980         |
| M20321Y      |                             | G1503 + 43980         |
| M20323R      |                             | 49182                 |
| M20325       |                             | 94233                 |
| M20328       |                             | 43980                 |
| M20332R      | 45662                       |                       |
| M20332Y      | 45663                       |                       |
| M20340R      |                             | 47242                 |
| M20340Y      |                             | 47243                 |
| M20350R      | G1902                       |                       |
| M20350Y      | G1903                       |                       |
| M20355       |                             | 43850                 |
| M20361Y      |                             | 47063                 |
| M20391R      | G2102                       |                       |
| M20391Y      | G2103                       |                       |
| M20395R      |                             | 46832                 |
| M20395Y      |                             | 46833                 |
| M23015R      |                             | G4602                 |
| M23015Y      |                             | G4603                 |
| M34260R      |                             | G3002                 |
| M34260Y      |                             | G3003                 |
| M34600R      |                             | G3092                 |
| M34600Y      | G3093                       |                       |
| M42100R      |                             | G4002                 |
| M42100Y      |                             | G4003                 |
| M42120R      |                             | G4002 + 92511         |
| M42201R      |                             | G4502                 |
| M42201Y      |                             | G4503                 |
| M42213R      |                             | G4502                 |
| M42213Y      |                             | G4503                 |
| M42220       | G5082                       |                       |
| M42320R      |                             | G4002                 |
| M42322R      |                             | G4002                 |
| M42322RCL    |                             | G4022                 |
| M42322Y      |                             | G4003                 |
| M42323R      |                             | G4002 + 92512         |
| M42323RCL    |                             | G4022 + 92512         |
| M42324       |                             | 62691                 |
| M42324-X     |                             | 62691-3               |
| M42339Y      |                             | G4003                 |



**MAXXIMA®-TO-GROTE®  
INTERCHANGE**

| Maxxima® PN | Grote® Form, Fit & Function | Grote® Fit & Function |
|-------------|-----------------------------|-----------------------|
| M42341R/Y   | G5300                       |                       |
| M42344R     | 54362                       |                       |
| M42346R     |                             | 54342                 |
| M42346R-X   |                             | 54342-3               |
| M42347      |                             | 62691                 |
| M42347-X    |                             | 62691-3               |
| M42348      |                             | 62101                 |
| M42348-X    |                             | 62101-3               |
| M42354R     |                             | 54602                 |
| M42362R/Y-A | G5530                       |                       |
| M42363R/Y-A | G5540                       |                       |
| M42365R     | 54342                       |                       |
| M42500R     |                             | 54342                 |
| M42500Y     |                             | 54343                 |
| M42701BCL   |                             | 77355                 |
| M42701R     |                             | 77352                 |
| M42701WCL   |                             | 77351                 |
| M42701Y     |                             | 77353                 |
| M43253      |                             | 43253                 |
| M43900      | 67150                       |                       |
| M49700      | 94180                       |                       |
| M50100-B    | 94010                       |                       |
| M50102-X    | 92070-3                     |                       |
| M50103      |                             | 43163                 |
| M50300-B    | 92120                       |                       |
| M50310      | 43673                       |                       |
| M50312      |                             | 43230                 |
| M50400-B    | 91740                       |                       |
| M50600-B    | 92420                       |                       |
| M50600-X    | 92420                       |                       |
| M50605      |                             | 43223                 |
| M50900      | 67090                       |                       |
| M50900-100  | 67090-3                     |                       |
| M50900-X    | 67090                       |                       |
| M50904      |                             | 66831                 |
| M50908      |                             | 66861                 |
| M50909      |                             | 44070                 |
| M50910      |                             | 99630                 |
| M50911      | 67000                       |                       |
| M50950      | 67001                       |                       |
| M50950A-100 |                             | 68551                 |
| M50950-X    | 67001-3                     |                       |
| M50951      | 66851                       |                       |
| M50951A-100 |                             | 68551                 |
| M50953      |                             | 66862                 |
| M56100R     |                             | G4002                 |
| M63100R     |                             | G6002                 |
| M63100Y     |                             | G6003                 |
| M63201BCL   |                             | 77365                 |
| M63201R     |                             | 77362                 |
| M63201WCL   |                             | 77361                 |
| M63201Y     |                             | 77363                 |
| M63253      | 43223                       |                       |
| M63253BLK   | 43222                       |                       |
| M63318R-A   | 53582                       |                       |
| M63320      |                             | 62751 + 42152         |
| M63320R     |                             | G6002 + 42152         |
| M63320Y     |                             | G6003 + 42152         |
| M63321R-X   |                             | G6002 + 42152         |
| M63322R     |                             | G6002                 |
| M63322RCL   |                             | G6003-3 + 42152       |
| M63322Y     | G6003                       |                       |
| M63322YCL   |                             | G6013 + 42152         |
| M63323R     |                             | G6002 + 43222         |
| M63323Y     |                             | G6003 + 43222         |
| M63323YCL   |                             | G6013 + 43222         |
| M63324      |                             | 62751 + 92420         |
| M63324-X    |                             | 62751-3 + 92420-3     |

| Maxxima® PN   | Grote® Form, Fit & Function | Grote® Fit & Function |
|---------------|-----------------------------|-----------------------|
| M63339Y       |                             | G6003                 |
| M63339YCL     |                             | G6013                 |
| M63340YCL     |                             | G6013                 |
| M63346R       |                             | G6002                 |
| M63346R-X     |                             | G6002-3               |
| M63347        |                             | 62751                 |
| M63347-X      |                             | 62751-3               |
| M63352R-X     |                             | G6002                 |
| M63420R       |                             | G6002                 |
| M63420Y       |                             | G6003                 |
| M63450R       |                             | G6002                 |
| M63450Y       |                             | G6003                 |
| M84415        |                             | 61611                 |
| M84420-B      |                             | 60581                 |
| M84427-A      | 61861                       |                       |
| M84429-B      | 61281                       |                       |
| M84444        | 61E61                       |                       |
| M85615R       |                             | 54682                 |
| M90061R       |                             | 53422                 |
| M90081Y       | 55983                       |                       |
| MEG-1         | 99170                       |                       |
| MHL-07HILO    | 90941-5                     |                       |
| MHL-4x6HI     | 94411-5                     |                       |
| MHL-4x6LL     | 94421-5                     |                       |
| MHL-5X7HILO   | 90951-5                     |                       |
| MPWL-10       | BZ501-5                     |                       |
| MPWL-10WALLCH | BZ801-5                     |                       |
| MPWL-20       | BZ501-5                     |                       |
| MPWL-20WALLCH | BZ801-5                     |                       |
| MPWL-30WALLCH | BZ801-5                     |                       |
| MWL-01B       | BZ101-5                     |                       |
| MWL-01HP      | BZ101-5                     |                       |
| MWL-04        |                             | 63611                 |
| MWL-07SP      | BZ301-5                     |                       |
| MWL-12        | 63821                       |                       |
| MWL-16        | 63F21                       |                       |
| MWL-19        | BZ101-5                     |                       |
| MWL-20        | BZ601-5                     |                       |
| MWL-21        |                             | 63611                 |
| MWL-24SP      | 63J21                       |                       |
| MWL-26        | 63621                       |                       |
| MWL-28        | BZ101-5                     |                       |
| MWL-30        | BZ201-5                     |                       |
| MWL-31SP      | 63E21                       |                       |
| MWL-39        | 63621                       |                       |
| MWL-40        | 63991                       |                       |
| MWL-50SP      | BZ301-5                     |                       |
| V435          | 60151                       |                       |

**OPTRONICS®-TO-GROTE®  
INTERCHANGE**

| Optronics® PN | Grote® Form, Fit & Function | Grote® Fit & Function |
|---------------|-----------------------------|-----------------------|
| 442           | 50902                       |                       |
| 212767        | 66200                       |                       |
| 00212135P     | 45853                       |                       |
| 00212207B     | 45793                       |                       |
| 00212209B     | 45792                       |                       |
| 00212211B     | 66200                       |                       |
| 00212211P     | 66200                       |                       |
| 00212212B     | 66200                       |                       |
| 00212220P     | 45793                       |                       |
| 00212226P     | 66200                       |                       |
| 00212231B     | 45763                       |                       |
| 00212231P     | 45763                       |                       |
| 00212233B     | 45762                       |                       |
| 00212233P     | 45762                       |                       |
| 00212235P     | 45773                       |                       |

| Optronics® PN | Grote® Form, Fit & Function | Grote® Fit & Function |
|---------------|-----------------------------|-----------------------|
| 00212237P     | 45772                       |                       |
| 00212251B     | 45783                       |                       |
| 00212251P     | 45783                       |                       |
| 00212257P     | 45792                       |                       |
| 00212307B     | 45623                       |                       |
| 00212316B     | 66200                       |                       |
| 00212316P     | 66200                       |                       |
| 00212317B     | 93453                       |                       |
| 00212317P     | 93453                       |                       |
| 00212333B     | 45572                       |                       |
| 00212333P     | 45572                       |                       |
| 00212335P     | 45583                       |                       |
| 00212338P     | 47772                       |                       |
| 00212342P     | 45593                       |                       |
| 00212345P     | 45603                       |                       |
| 00212351B     | 45613                       |                       |
| 00212351P     | 45613                       |                       |
| 00212353B     |                             | 45572                 |
| 00212353P     |                             | 45572                 |
| 00212355P     | 45623                       |                       |
| 00212704P     | 47913                       |                       |
| 00212705P     | 47912                       |                       |
| 00212706P     | 47923                       |                       |
| 00212707P     | 47922                       |                       |
| 442L          | 50912                       |                       |
| A111GLPBP     | 42162                       |                       |
| A11AB         | 92433                       |                       |
| A11ABP        | 92433                       |                       |
| A11DB         | 42282                       |                       |
| A11GLPB       | 42162                       |                       |
| A11RB         | 92432                       |                       |
| A11RBP        | 92432                       |                       |
| A2RB          | 91122                       |                       |
| A2RBP         | 91122                       |                       |
| A31AB         |                             | 90203                 |
| A31RB         |                             | 90202                 |
| A31RBP        |                             | 90202                 |
| A33GB         | 94180                       |                       |
| A33GBP        | 94180                       |                       |
| A38AB         | 90203                       |                       |
| A38ABP        | 90203                       |                       |
| A38RB         | 90202                       |                       |
| A38RBP        | 90202                       |                       |
| A40RB         | 90012                       |                       |
| A40RBP        | 90012                       |                       |
| A40SRB        | 99595                       |                       |
| A40SRBP       | 99595                       |                       |
| A45BB         | 92512-3                     |                       |
| A45BBP        | 92512                       |                       |
| A45CB         | 67010                       |                       |
| A45CBP        | 67010                       |                       |
| A45GB         | 91740-3                     |                       |
| A45GBP        | 91740                       |                       |
| A45PB         | 67000-3                     |                       |
| A45PBP        | 67000                       |                       |
| A45PMB        | 66861                       |                       |
| A45PMBP       | 66861                       |                       |
| A45PS         | 67000                       |                       |
| A45SBP        | 43253-3                     |                       |
| A46PB         | 67050-3                     |                       |
| A46PBP        | 67050-3                     |                       |
| A46PS         | 67050-5                     |                       |
| A47PB         | 67090                       |                       |
| A47PBP        | 67090                       |                       |
| A47PS         | 67090-5                     |                       |
| A49PB         | 67014                       |                       |
| A49PBP        | 67014                       |                       |
| A54GBP        | 92120                       |                       |
| A54GKP        | 94100                       |                       |
| A55GBP        | 91410                       |                       |
| A56GBP        | 92070                       |                       |
| A57GBP        | 91400                       |                       |
| A57GKP        | 94010                       |                       |

**OPTRONICS® -TO-GROTE®  
 INTERCHANGE**

| Optronics® PN | Grote® Form, Fit & Function | Grote® Fit & Function |
|---------------|-----------------------------|-----------------------|
| A58GB         | 91880                       |                       |
| A60RBP        | 91302                       |                       |
| A66PBP        | 43850                       |                       |
| A68AB         | 90153                       |                       |
| A68ABP        | 90153                       |                       |
| A68P          |                             | 66981                 |
| A68RB         | 90152                       |                       |
| A68RBP        | 90152                       |                       |
| A70GBP        | 92420                       |                       |
| A78CB         | 42153                       |                       |
| A81AB         | 90923                       |                       |
| A81ABP        | 90923                       |                       |
| A81RB         | 90922                       |                       |
| A81RBP        | 90922                       |                       |
| A8R           | 92792                       |                       |
| A8RB          | 92792                       |                       |
| A8RBP         | 92792                       |                       |
| A91ABP        | 46413                       |                       |
| A91GB         | 91380                       |                       |
| A91GBP        | 91380                       |                       |
| A91LW         |                             | 67120                 |
| A91LWP        |                             | 67120                 |
| A91OB         | 94233                       |                       |
| A91OBP        | 92433                       |                       |
| A91RB         | 46412                       |                       |
| A91RBP        | 46412                       |                       |
| A93PB         | 69710                       |                       |
| A93PBP        | 69710                       |                       |
| A9R           | 91112                       |                       |
| A9RB          | 91112                       |                       |
| A9RBP         | 91112                       |                       |
| A9TB          | 91112                       |                       |
| AL12GLPB      | 43962                       |                       |
| AL12GLPBP     | 43962                       |                       |
| AL45PWTP      | 66860                       |                       |
| AL45PWTPBP    | 66860                       |                       |
| AL90AS        | G1903-5                     |                       |
| AL90RBP       | 47082                       |                       |
| AL91RBP       | 47082                       |                       |
| BK42CB        | 43673                       |                       |
| BK42CBP       | 43673                       |                       |
| BK45BBP       | 43572                       |                       |
| BK53BB        |                             | 93760                 |
| BK53BBP       |                             | 93760                 |
| BK557GB       | 42180                       |                       |
| BK557GBP      | 42180                       |                       |
| BK55BB        | 43512                       |                       |
| BK55BBP       | 43512                       |                       |
| BK57BB        |                             | 93750                 |
| BK57BBP       |                             | 93750                 |
| BK66DB        | 43230                       |                       |
| BK66DBP       | 43230                       |                       |
| BK70BBP       | 43362-3                     |                       |
| BU31CB        | 62291                       |                       |
| BU31CBP       | 62291                       |                       |
| BU33CBP       | 62381                       |                       |
| BU44CB        | 62221                       |                       |
| BU44CBP       | 62221                       |                       |
| BU70CBP       | 62521                       |                       |
| BUL003CB      | 62091-3                     |                       |
| BUL003CKB     |                             | 62091 + 91740         |
| BUL06CBP      | 62691                       |                       |
| BUL10CBP      | 62751                       |                       |
| BUL11CB       | 62691-3                     |                       |
| BUL11CKB      |                             | 62691 + 67090 + 91740 |
| BUL11CKBP     |                             | 62691 + 67090 + 91740 |
| BUL11CMBP     | 62101                       |                       |

| Optronics® PN | Grote® Form, Fit & Function | Grote® Fit & Function |
|---------------|-----------------------------|-----------------------|
| BUL16CBP      | 62691                       |                       |
| BUL23CB       | 62691-3                     |                       |
| BUL23CBP      | 62691                       |                       |
| BUL43CB       | 64971-3                     |                       |
| BUL43CBP      | 64971                       |                       |
| BUL53CB       | 62691-3                     |                       |
| BUL53CBP      | 62691                       |                       |
| BUL53CKB      |                             | 62691 + 67090 + 91740 |
| BUL53CKBP     |                             | 62691 + 67090 + 91740 |
| BUL69CB       | 60581                       |                       |
| BUL72CBGK     |                             | 61G31 + 92420         |
| BUL72CBGKP    |                             | 61G31 + 92420         |
| CB11AS        | 46543-5                     |                       |
| CB11WAB       | 46543                       |                       |
| CB11WABP      |                             | 46543                 |
| CBL22ABP      | G5053                       |                       |
| HLL78LS       | 94421-5                     |                       |
| HLL79HS       | 94411-5                     |                       |
| HLL90HLBP     | 90941-5                     |                       |
| HLL93HLS      | 90941-5                     |                       |
| IL21CS        | 61491-5                     |                       |
| IL31CS        | 61091                       |                       |
| IL91CBP       |                             | 61821                 |
| ILL08COBP     | 61291                       |                       |
| ILL10CCB      | 61291-3                     |                       |
| ILL10CCBP     | 61291-3                     |                       |
| ILL28CMB      | 61H91-3                     |                       |
| ILL28CMBP     | 61H91                       |                       |
| ILL28CMGP     | 61F61-3                     |                       |
| ILL28CMGPBP   | 61F61                       |                       |
| ILL31CB       | 61871                       |                       |
| ILL32CBP      | 61861                       |                       |
| ILL35CB       | 61871                       |                       |
| ILL71CB       | 61E81                       |                       |
| LP11CS        | 60101-5                     |                       |
| LP21CB        | 60151                       |                       |
| LP21CBP       | 60151                       |                       |
| LP21CS        | 60151-5                     |                       |
| LP25SB        | 43962                       |                       |
| LP25SBP       | 43962                       |                       |
| LP25SGGBP     | 43960                       |                       |
| LP26SKB       | 60460                       |                       |
| LP26SKBP      | 60460                       |                       |
| LP31CS        | 61501-5                     |                       |
| LP56CBP       | 60001                       |                       |
| LP5SB         |                             | 43272                 |
| LP5SBP        |                             | 43272                 |
| LP65CB        | 60291-3                     |                       |
| LP65CBP       | 60291                       |                       |
| LP91CBP       | 60261                       |                       |
| LPL26SKB      | 60681                       |                       |
| LPL26SKBP     | 60681                       |                       |
| LPL31CB       | G6151                       |                       |
| LPL31CBP      | G6151                       |                       |
| LPL31CEZB     | G6151                       |                       |
| LPL31CEZBP    | G6151                       |                       |
| LPL42CBF      | 60381-3                     |                       |
| LPL42CBFP     | 60381                       |                       |
| MC11AB        |                             | 46883                 |
| MC11ABP       |                             | 46883                 |
| MC11RB        |                             | 46882                 |
| MC11RBP       |                             | 46882                 |
| MC21RS        | 45022                       |                       |
| MC22AB        | 45023                       |                       |
| MC22ABP       | 45023                       |                       |
| MC22RB        | 45022                       |                       |
| MC22RBP       | 45022                       |                       |
| MC25AB        | 47103                       |                       |
| MC25ABP       | 47103                       |                       |
| MC25RB        | 47102                       |                       |

| Optronics® PN | Grote® Form, Fit & Function | Grote® Fit & Function |
|---------------|-----------------------------|-----------------------|
| MC25RBP       | 47102                       |                       |
| MC27AB        | 45323                       |                       |
| MC27ABP       | 45323                       |                       |
| MC27RB        | 45322                       |                       |
| MC27RBP       | 45322                       |                       |
| MC31AB        |                             | 45933                 |
| MC31ABP       |                             | 45933                 |
| MC31RB        |                             | 45932                 |
| MC31RBP       |                             | 45932                 |
| MC35AB        | 46393                       |                       |
| MC35ABP       | 46393                       |                       |
| MC36ABP       | 46983-5                     |                       |
| MC36RB        | 46982-5                     |                       |
| MC36RBP       | 46982-5                     |                       |
| MC37ABP       | 46983-5                     |                       |
| MC38AB        | 45933                       |                       |
| MC38ABP       | 45933                       |                       |
| MC38RB        | 45932                       |                       |
| MC38RBP       | 45932                       |                       |
| MC42AB        | 46793-3                     |                       |
| MC42ABP       | 46793                       |                       |
| MC42RB        | 46792-3                     |                       |
| MC42RBP       | 46792                       |                       |
| MC42RS        | 91962                       |                       |
| MC53AB        | 45823-3                     |                       |
| MC53ABP       | 45823                       |                       |
| MC53ABSB      | 78333-3                     |                       |
| MC53ABSBP     | 78333                       |                       |
| MC53RBP       | 45822                       |                       |
| MC55ABKP      | 45043                       |                       |
| MC55ABP       | 45813                       |                       |
| MC55RB        | 45812-3                     |                       |
| MC55RBKP      | 45042                       |                       |
| MC55RBP       | 45812                       |                       |
| MC57AB        | 45833-3                     |                       |
| MC57ABP       | 45833                       |                       |
| MC57RB        | 45832-3                     |                       |
| MC57RBP       | 45832                       |                       |
| MC58AS        | 45413                       |                       |
| MC58RS        | 45412                       |                       |
| MC65AB        | 46743-3                     |                       |
| MC65ABP       | 46743                       |                       |
| MC65ARBP      | 46740                       |                       |
| MC65RB        | 46742-3                     |                       |
| MC65RBP       | 46742                       |                       |
| MC67AB        |                             | 45093                 |
| MC67ABP       |                             | 45093                 |
| MC67RB        |                             | 45092                 |
| MC67RBP       |                             | 45092                 |
| MC68AB        | 45253-3                     |                       |
| MC68ABP       | 45253                       |                       |
| MC68AS        | 45253-5                     |                       |
| MC68RBP       | 45252                       |                       |
| MC68RS        | 45253-5                     |                       |
| MC71AS        |                             | 47053                 |
| MC71RS        |                             | 47052                 |
| MC77RB        |                             | 49062                 |
| MC77RBP       |                             | 49062                 |
| MC81AB        | 46283-3                     |                       |
| MC81ABP       | 46283                       |                       |
| MC81RB        | 46282-3                     |                       |
| MC81RBP       | 46282                       |                       |
| MC82AB        | 45173                       |                       |
| MC82ABP       | 45173                       |                       |
| MC82RB        | 45172                       |                       |
| MC82RBP       | 45172                       |                       |
| MC90AS        | 46413-5                     |                       |
| MC90RS        | 46412-5                     |                       |
| MC93RB        | 49172-3                     |                       |
| MC93RBP       | 49172                       |                       |
| MC99RB        | 49112                       |                       |
| MC99RBP       | 49112                       |                       |

**OPTRONICS®-TO-GROTE®  
INTERCHANGE**

| Optronics® PN | Grote® Form, Fit & Function | Grote® Fit & Function |
|---------------|-----------------------------|-----------------------|
| MC99RK        | 49112-5                     |                       |
| MCC55ABP      | 45813-3                     |                       |
| MCL111AKPG    | 49333-3                     |                       |
| MCL111AKPGP   | 49333                       |                       |
| MCL111RKPG    | 49332-3                     |                       |
| MCL111RKPGP   | 49332                       |                       |
| MCL11AHPG     | 49333-3                     |                       |
| MCL11RHPPG    | 49332-3                     |                       |
| MCL12RKPG     | 49322-3                     |                       |
| MCL155ABP     | 47113                       |                       |
| MCL155RBP     | 47112                       |                       |
| MCL157ABP     | 47123                       |                       |
| MCL165ABP     | 47093                       |                       |
| MCL165RBP     | 47092                       |                       |
| MCL21ABP      | G3093                       |                       |
| MCL21RBP      | G3092                       |                       |
| MCL23ABP      | G1083                       |                       |
| MCL23RBP      | G1082                       |                       |
| MCL299AB      | 45283                       |                       |
| MCL299RB      | 45282                       |                       |
| MCL45ABP      | G4603                       |                       |
| MCL46ABP      | G4603                       |                       |
| MCL46RBP      | G4602                       |                       |
| MCL505ABSB    |                             | 78433 + 43152         |
| MCL505GABSB   |                             | 78433 + 92120         |
| MCL50AB       | G3003-3                     |                       |
| MCL50ABP      | G3003                       |                       |
| MCL50RB       | G3002-3                     |                       |
| MCL50RBP      | G3002                       |                       |
| MCL51AB       | 47123-3                     |                       |
| MCL51ABP      | 47123                       |                       |
| MCL51RB       | 47122-3                     |                       |
| MCL51RBP      | 47122                       |                       |
| MCL527AFB     |                             | 47123 + 43162         |
| MCL527AS      | G1033-5                     |                       |
| MCL527RB      | 47122-3                     |                       |
| MCL527RBP     | 47122                       |                       |
| MCL527RFB     |                             | 47122 + 43162         |
| MCL527RS      | G1032-5                     |                       |
| MCL54AB       | 46133                       |                       |
| MCL54ABP      | 46133                       |                       |
| MCL54RB       | 46132                       |                       |
| MCL54RBP      | 46132                       |                       |
| MCL55AB       | 47113-3                     |                       |
| MCL55ABP      | 47113                       |                       |
| MCL55AKB      |                             | G3003 + 67050 + 92120 |
| MCL55FRB      | 43532                       |                       |
| MCL55RB       | 47112-3                     |                       |
| MCL55RBP      | 47112                       |                       |
| MCL55RKB      |                             | G3002 + 67050 + 92120 |
| MCL56AB       | 47113-3                     |                       |
| MCL56ABP      | 47113                       |                       |
| MCL56AFB      |                             | 47113 + 43152         |
| MCL56AS       | G3003-5                     |                       |
| MCL56RB       | 47112-3                     |                       |
| MCL56RBP      | 47112                       |                       |
| MCL56RFB      |                             | 47122 + 43152         |
| MCL56RS       | G3002-5                     |                       |
| MCL57AB       | 47123-3                     |                       |
| MCL57ABP      | 47123                       |                       |
| MCL57RB       | 47122-3                     |                       |
| MCL57RBP      | 47122                       |                       |
| MCL57RCB      | G1042                       |                       |
| MCL57RCBP     | G1042                       |                       |
| MCL58AB       | 46143-3                     |                       |
| MCL58ABP      | 46143                       |                       |
| MCL58RB       | 46142-3                     |                       |
| MCL58RBP      | 46142                       |                       |

| Optronics® PN  | Grote® Form, Fit & Function | Grote® Fit & Function |
|----------------|-----------------------------|-----------------------|
| MCL59ABP       | G1003                       |                       |
| MCL59RBP       | G1002                       |                       |
| MCL61ABP       | G1903                       |                       |
| MCL61AS        | G1903-5                     |                       |
| MCL61RB        | G1902-3                     |                       |
| MCL61RBP       | G1902                       |                       |
| MCL63ABP       | G1903                       |                       |
| MCL63RB        | G1902-3                     |                       |
| MCL63RBP       | G1902                       |                       |
| MCL65AB        | G1903-3                     |                       |
| MCL65ABP       | G1903                       |                       |
| MCL65RB        | G1902-3                     |                       |
| MCL65RBP       | G1902                       |                       |
| MCL66AB        | 47243-3                     |                       |
| MCL66ABP       | 47243                       |                       |
| MCL66RB        | 47242-3                     |                       |
| MCL66RBP       | 47242                       |                       |
| MCL67RB        |                             | G1902 + 43790         |
| MCL67RBP       |                             | G1902 + 43790         |
| MCL75AB        | G1903-3                     |                       |
| MCL75ABP       | G1903                       |                       |
| MCL75RBP       | G1902                       |                       |
| MCL76AB        | G2103-3                     |                       |
| MCL76ABP       | G2103                       |                       |
| MCL76RB        | G2102-3                     |                       |
| MCL76RBP       | G2102                       |                       |
| RB10A          |                             | 76033                 |
| RB15RBP        | 40132                       |                       |
| RE10AB         | 40303                       |                       |
| RE10ABP        | 40303                       |                       |
| RE10RB         | 40302                       |                       |
| RE10RBP        | 40302                       |                       |
| RE11AB         | 41033-3                     |                       |
| RE11ABP        | 41033                       |                       |
| RE11RB         | 41032-3                     |                       |
| RE11RBP        | 41032                       |                       |
| RE12AK         |                             | 41033                 |
| RE12RK         |                             | 41032                 |
| RE15AB         | 40133                       |                       |
| RE15ABP        | 40133                       |                       |
| RE15AK         |                             | 40133-5               |
| RE15RB         | 40132                       |                       |
| RE15RK         |                             | 40132-5               |
| RE18T          |                             | 40650-5               |
| RE2018T        | 40650-5                     |                       |
| RE21AB         | 40053                       |                       |
| RE21ABP        | 40053                       |                       |
| RE21AS         | 40053                       |                       |
| RE21RB         | 40052-3                     |                       |
| RE21RBP        | 40052                       |                       |
| RE21RS         | 40052-5                     |                       |
| RE31AS         | 40233-5                     |                       |
| RE31RS         | 40232-5                     |                       |
| RE35AB         | 41013                       |                       |
| RE35ABP        | 41013                       |                       |
| RE35RB         | 41012                       |                       |
| RE35RBP        | 41012                       |                       |
| RE37AB         | 41003                       |                       |
| RE37ABP        | 41003                       |                       |
| RE37RB         | 41002                       |                       |
| RE37RBP        | 41002                       |                       |
| RE418T         |                             | 40650-5               |
| RT150WBDP      | 40641                       |                       |
| RT150Y2BP      | 41133                       |                       |
| RTR03150711CBP | 40650                       |                       |
| RTR1015066CB   |                             | 41050                 |
| RTR1015066CBP  | 41050                       |                       |
| RTR10150711CBP | 40650                       |                       |
| RTR10150WBP    | 40641                       |                       |
| RTR15066B      | 41050                       |                       |
| RTR15066BP     | 41050                       |                       |
| RTR150711B     | 41160-3                     |                       |
| RTR150711BP    | 41160                       |                       |

| Optronics® PN | Grote® Form, Fit & Function | Grote® Fit & Function |
|---------------|-----------------------------|-----------------------|
| RTR150711BPB  | 41160                       |                       |
| RVSL21        | 61793                       |                       |
| RVSL21P       | 61793                       |                       |
| ST16RB        | 52482                       |                       |
| ST17RB        | 52492                       |                       |
| ST24RBP       | 50862                       |                       |
| ST25RBP       | 50852                       |                       |
| ST2RB         | 52442                       |                       |
| ST2RBP        | 52442                       |                       |
| ST31RB        | 53132                       |                       |
| ST31RBP       | 53132                       |                       |
| ST33AB        | 52203                       |                       |
| ST33ABP       | 52203                       |                       |
| ST33RBP       | 52202                       |                       |
| ST3RB         | 52452                       |                       |
| ST40RB        | 50232                       |                       |
| ST40RBP       | 50232                       |                       |
| ST40RS        | 50232-5                     |                       |
| ST44AB        |                             | 52923 + 91740 + 67090 |
| ST44RBP       | 53012                       |                       |
| ST45RGB       | 53102-3                     |                       |
| ST45RGBP      | 53102                       |                       |
| ST45RK        | 53012-5                     |                       |
| ST45RS        | 52922-5                     |                       |
| ST46RB        | 52672-3                     |                       |
| ST46RBP       | 52672                       |                       |
| ST46RKB       | 52682                       |                       |
| ST46RKBP      | 52682                       |                       |
| ST4RB         | 51932                       |                       |
| ST4RBP        | 51932                       |                       |
| ST52AAP       | 55223                       |                       |
| ST52RA        | 55220                       |                       |
| ST52RB        | 50630                       |                       |
| ST52RBP       | 50630                       |                       |
| ST56RS        | 53812                       |                       |
| ST57RS        | 53822                       |                       |
| ST5RB         | 51942                       |                       |
| ST5RBP        | 51942                       |                       |
| ST70ABP       | 52183                       |                       |
| ST70RB        | 52892-3                     |                       |
| ST70RBP       | 52892                       |                       |
| ST70RS        | 52182-5                     |                       |
| ST74AB        | 53093                       |                       |
| ST74ABP       | 53093                       |                       |
| ST74RBP       | 53092                       |                       |
| ST75ABP       | 52513                       |                       |
| ST77AB        | 52253                       |                       |
| ST77ABP       | 52253                       |                       |
| ST7RBP        | 53672                       |                       |
| ST8RBP        | 52302                       |                       |
| ST90RBP       | 50132                       |                       |
| ST9RBP        | 52312                       |                       |
| ST9RS         | 52312-5                     |                       |
| STL002RFB     |                             | 54172 + 42152         |
| STL003AB      | 54333                       |                       |
| STL003RFB     | 54482                       |                       |
| STL003RK      |                             | 54332 + 66815         |
| STL003RMBP    | 54362                       |                       |
| STL003SRFLB   |                             | 52922 + 92512         |
| STL008RB      | 51982                       |                       |
| STL008RBP     | 51982                       |                       |
| STL008RPG     | 51982                       |                       |
| STL008RS      | 51982-5                     |                       |
| STL009RB      | 51992                       |                       |
| STL009RPG     | 51992                       |                       |
| STL009RS      | 51992-5                     |                       |
| STL101ABP     | G4003                       |                       |
| STL101RMBP    | 53552                       |                       |
| STL12RMBP     | 54142                       |                       |
| STL13K        |                             | 54342 + 67090 + 91740 |
| STL13RB       | 54342-3                     |                       |

**OPTRONICS®-TO-GROTE®  
INTERCHANGE**

| Optronics® PN | Grote® Form, Fit & Function | Grote® Fit & Function |
|---------------|-----------------------------|-----------------------|
| STL13RBP      | 54342                       |                       |
| STL13RGBP     | 53252                       |                       |
| STL13RMB      | 53552-3                     |                       |
| STL13RMBP     | 53552                       |                       |
| STL153ARDBBP  | G5530                       |                       |
| STL190RBP     | 53422                       |                       |
| STL201RFMB    |                             | 55162 + 92512         |
| STL22AB       | G6003-3                     |                       |
| STL22ABP      | G6003                       |                       |
| STL22RB       | G6002-3                     |                       |
| STL22RBP      | G6002                       |                       |
| STL22RCBP     | G6012                       |                       |
| STL23ABP      | G4003                       |                       |
| STL23RB       | G4002-3                     |                       |
| STL23RBP      | G4002                       |                       |
| STL28RBP      | 51982                       |                       |
| STL29RBP      | 51992                       |                       |
| STL33RB       | G4502                       |                       |
| STL33RBP      | G4502                       |                       |
| STL34RB       |                             | 52202 + 94180 + 67090 |
| STL35AB       | G4503                       |                       |
| STL35RBP      | G4502                       |                       |
| STL412RB      | 54172-3                     |                       |
| STL412RBP     | 54172                       |                       |
| STL413RB      | 54342-3                     |                       |
| STL413RBP     | 54342                       |                       |
| STL413RMB     | 54362-3                     |                       |
| STL413RMBP    | 54362                       |                       |
| STL42RMBP     | 53292                       |                       |
| STL43RB       | 54342-3                     |                       |
| STL43RBP      | 54342                       |                       |
| STL43RMB      | 53252-3                     |                       |
| STL43RMBP     | 53252                       |                       |
| STL52ARBP     | G5300                       |                       |
| STL543AB      | G4003-3                     |                       |
| STL543ABP     | G4003                       |                       |
| STL543RB      | G4002-3                     |                       |
| STL543RBP     | G4002                       |                       |
| STL55ABP      | G4003                       |                       |
| STL55RB       | G4002-3                     |                       |
| STL55RBP      | G4002                       |                       |
| STL55RMB      | 53312-3                     |                       |
| STL55RMBP     | 54562                       |                       |
| STL572AB      | G6003-3                     |                       |
| STL572ABP     | G6003                       |                       |
| STL572RB      | G6002-3                     |                       |
| STL572RBP     | G6002                       |                       |
| STL60RB       | G5082                       |                       |
| STL60RBP      | G5082-5                     |                       |
| STL6RS        | 51982-5                     |                       |
| STL70AB       | G6003-3                     |                       |
| STL70ABP      | G6003                       |                       |
| STL70RB       | G6002-3                     |                       |
| STL70RBP      | G6002                       |                       |
| STL71AMB      | 54193-3                     |                       |
| STL71AMBP     | 54193                       |                       |
| STL72AB       | G6003                       |                       |
| STL72ABP      | G6003                       |                       |
| STL72RB       | G6002-3                     |                       |
| STL72RBP      | G6002                       |                       |
| STL72RMB      | 53962-3                     |                       |
| STL72RMBP     | 53962                       |                       |
| STL74RBK      |                             | G6002 + 67090 + 92420 |
| STL74RBKP     |                             | G6002 + 67090 + 92420 |
| STL75AMBP     | 54213                       |                       |
| STL7RS        | 51992-5                     |                       |
| STL8RB        | 51982                       |                       |

| Optronics® PN | Grote® Form, Fit & Function | Grote® Fit & Function |
|---------------|-----------------------------|-----------------------|
| STL90ABP      | 55993                       |                       |
| STL90RB       | 55992                       |                       |
| STL90RBP      | 55992                       |                       |
| STL9RB        | 51992                       |                       |
| TL10CB        | 64931                       |                       |
| TL10CBP       | 64931                       |                       |
| TL10CS        | 64931-5                     |                       |
| TL15RK        | 65300-5                     |                       |
| TL27BK        | 65370-5                     |                       |
| TL29BK        | 65370-5                     |                       |
| TL5RK         | 65230-5                     |                       |
| TL6K          | 65440-5                     |                       |
| TLL22RK       |                             | G6002 + 67090 + 92420 |
| TLL45FBP      | 63861                       |                       |
| TLL46CFB      | BZ201-5                     |                       |
| TLL46CFBP     | BZ201-5                     |                       |
| TLL48FBP      | BZ201-5                     |                       |
| TLL52FB       | BZ601-5                     |                       |
| TLL52FBP      | BZ601-5                     |                       |
| TLL54TB       | 63991                       |                       |
| TLL54TBP      | 63991                       |                       |
| TLL55FB       | 63991                       |                       |
| TLL55FBP      | 63991                       |                       |
| TLL60FBP      | BZ301-5                     |                       |
| TLL64FB       | 63F51                       |                       |
| TLL70FB       | 63L71                       |                       |
| TLL71FB       | 63991                       |                       |
| TLL71FBP      | 63991                       |                       |
| TLL9RK        | 65320-5                     |                       |
| UCL178RFP2B   |                             | 61G31 + 42152         |
| UCL21CS       | 64J11                       |                       |
| UCL55CBP      | 60561                       |                       |
| UCL65CBP      | 60411                       |                       |
| UL53CB        | 45821                       |                       |
| UL53CBP       | 45821                       |                       |
| UL95CB        | 60271                       |                       |
| UL95CBP       | 60271                       |                       |
| ULL22CB       | 64J31                       |                       |

**AUTOMANN®-TO-GROTE®  
INTERCHANGE**

| Automann® PN | Grote® Form, Fit & Function | Grote® Fit & Function |
|--------------|-----------------------------|-----------------------|
| 564.46059    | 54233                       |                       |
| 564.46068    | 47063                       |                       |
| 577.4601     | 48522                       |                       |
| 571.LD27A16  | 45583                       |                       |
| 571.LD27R16  | 45582                       |                       |
| 571.LG162LB  | 60081                       |                       |
| 571.PT116    | 67001                       |                       |

**COLE HERSEE®-TO-GROTE®  
INTERCHANGE**

| Cole Hersee® PN | Grote® Form, Fit & Function | Grote® Fit & Function |
|-----------------|-----------------------------|-----------------------|
| 2560            | 68170                       |                       |
| DL-75-12V       | 60101                       |                       |

**ECCO®-TO-GROTE®  
INTERCHANGE**

| ECCO® PN   | Grote® Form, Fit & Function | Grote® Fit & Function |
|------------|-----------------------------|-----------------------|
| 520        | 73040                       |                       |
| 530        |                             | 73090                 |
| 575        |                             | 73090                 |
| 585        |                             | 73040                 |
| 777        |                             | 73080                 |
| 3510A      |                             | 78143                 |
| 3715A      |                             | 78143                 |
| 3730A      |                             | 78163                 |
| 3730C      |                             | 78161                 |
| 3735A      |                             | 78163                 |
| 3735C      |                             | 78161                 |
| 3811A      |                             | 78193 + 98480         |
| 5315A      | 78513                       |                       |
| 5545A      | 77223                       |                       |
| 5580CA     |                             | 76943                 |
| 5580CA-VM  |                             | 76953                 |
| 5590CAC-VM |                             | 76990                 |
| 5590CA-VM  |                             | 76943                 |
| 5810A      |                             | 78123                 |
| 6225A      |                             | 78113                 |
| 6260A      | 78113                       |                       |
| 630N       |                             | 73250                 |
| 6410A      | 78093                       |                       |
| 6410A-MG   | 78103                       |                       |
| 6465A      | 78093                       |                       |
| 6550A      |                             | 78853                 |
| 6550A-VM   |                             | 78863                 |
| 6550C      |                             | 78851                 |
| 6570A      |                             | 78063                 |
| 6570A-VM   |                             | 78863                 |
| 6650A      |                             | 78853                 |
| 6670A      |                             | 78063                 |
| 6670A-VM   |                             | 78863                 |
| 6710A      |                             | 78853                 |
| 7160A      |                             | 78033                 |
| 7460A      |                             | 78033                 |
| 7945A      |                             | 78853                 |
| 7945A-VM   |                             | 78863                 |
| 7960A      |                             | 78053                 |
| 7965A      |                             | 78033                 |
| 7965A-VM   |                             | 78043                 |
| 7970A      |                             | 78053                 |
| 7970A-VM   |                             | 78053                 |
| 850N       |                             | 73070                 |
| 9014A      |                             | 77933                 |
| 9014C      |                             | 77931                 |
| A3730DCK   |                             | 98360                 |
| A3932BZC   |                             | 98480                 |
| A6050BG    |                             | 98470                 |
| EB7180A    |                             | 78033                 |
| EB7185CAC  |                             | 78071                 |
| ED0002C    |                             | 78161                 |
| ED0002R    |                             | 78162                 |
| ED0003C    |                             | 78161                 |
| ED0004A    |                             | 78163                 |
| ED0004C    |                             | 78161                 |
| ED0004R    |                             | 78162                 |
| ED3702AC   |                             | 78460                 |
| ED3766AC   |                             | 78460                 |
| R5812BH    | 90620                       |                       |
| R6501FT    | 92970                       |                       |
| SA901      |                             | 73240                 |
| SA950      |                             | 73110                 |
| SA955      |                             | 73220                 |
| SW15       | 44421                       |                       |

**NAPA® WIRE-TO-GROTE® INTERCHANGE**

| Napa® Wire PN | Grote® Form, Fit & Function | Grote® Fit & Function |
|---------------|-----------------------------|-----------------------|
| 787107        | 68110                       |                       |
| 787125        | 68080                       |                       |

**PAI WIRE-TO-GROTE® INTERCHANGE**

| PAI PN | Grote® Form, Fit & Function | Grote® Fit & Function |
|--------|-----------------------------|-----------------------|
| 4197   |                             | 90303 + 45993         |
| 4261   | 48542                       |                       |
| 4263   | 53052                       |                       |
| 4274   | 45333                       |                       |
| 4286   | 50992                       |                       |
| 4287   | 61031                       |                       |
| 4292   | 46813                       |                       |
| 4294   |                             | 91302                 |
| 4295   | 92183                       |                       |
| 4298   | 91583                       |                       |
| 4304   | 61821                       |                       |
| 4307   | 45413                       |                       |
| 4997   | 48402                       |                       |
| 5278   |                             | G5543-5               |
| 5279   | G5543-5                     |                       |
| 5289   | 46813                       |                       |
| 5313   | G4002                       |                       |

**PHILLIPS®-TO-GROTE® INTERCHANGE**

| Phillips® PN | Grote® Form, Fit & Function | Grote® Fit & Function |
|--------------|-----------------------------|-----------------------|
| 22-4321      | 87110                       |                       |
| 22-4621      | 87111                       |                       |
| 22-9621      | 87023                       |                       |
| 24-4321      | 87110                       |                       |
| 24-4621      | 87111                       |                       |
| 30-2051      | 87171                       |                       |
| 30-2071      | 87172                       |                       |
| 30-4321      | 87100                       |                       |
| 30-4621      | 87101                       |                       |
| 30-4920      | 87170                       |                       |
| 30-4921      | 87170                       |                       |
| 30-9620      | 87101                       |                       |
| 30-9624      | 87101                       |                       |

**TRAMEC SLOAN®-TO-GROTE® INTERCHANGE**

| TRAMEC SLOAN® PN | Grote® Form, Fit & Function | Grote® Fit & Function |
|------------------|-----------------------------|-----------------------|
| 421007           | 87020                       |                       |
| 421010           | 87110                       |                       |
| 421113           | 87111                       |                       |
| 421115           | 87023                       |                       |
| 421129           | 87100                       |                       |
| 421130           | 87101                       |                       |
| 421166           | 87171                       |                       |
| 421167           | 87172                       |                       |
| 421200           | 87172                       |                       |
| 421202           | 87171                       |                       |

**VELVAC®-TO-GROTE® INTERCHANGE**

| VELVAC® PN | Grote® Form, Fit & Function | Grote® Fit & Function |
|------------|-----------------------------|-----------------------|
| 590154     | 87020                       |                       |
| 590155     | 87023                       |                       |
| 590156     | 87110                       |                       |
| 590157     | 87111                       |                       |
| 590159     | 87180                       |                       |
| 590160     | 87100                       |                       |
| 590161     | 87101                       |                       |
| 590163     | 87170                       |                       |
| 590165     | 87171                       |                       |
| 590166     | 87172                       |                       |
| 590178     | 87182                       |                       |

**VSM®-TO-GROTE® INTERCHANGE**

| VSM® PN | Grote® Form, Fit & Function | Grote® Fit & Function |
|---------|-----------------------------|-----------------------|
| 254     | 44710                       |                       |
| 262     | 44530                       |                       |
| 1010    | 45812                       |                       |
| 1011    | 45832                       |                       |
| 1013    | 49142                       |                       |
| 1015    | G1032                       |                       |
| 1030    | 45822                       |                       |
| 1035    | G3002                       |                       |
| 1211    | 46792                       |                       |
| 1500    | 46412                       |                       |
| 1505    | G1502                       |                       |
| 1900    | 46742                       |                       |
| 1905    | G1902                       |                       |
| 3305    | 49332                       |                       |
| 4054    | 53012                       |                       |
| 4064    | 52922                       |                       |
| 4440    | 53552                       |                       |
| 4454    | G4012                       |                       |
| 4464    | G4002                       |                       |
| 5016    | 53722                       |                       |
| 6054    | 53092                       |                       |
| 6064    | 52182                       |                       |
| 6440    | 54142                       |                       |
| 6454    | G6002                       |                       |
| 6464    | G6002                       |                       |
| 7562    | 90941-5                     |                       |
| 9093    | 91572                       |                       |
| 9119    | 91400                       |                       |
| 9122    | 67050                       |                       |
| 9124    | 67000                       |                       |
| 9127    | 91740                       |                       |
| 9128    | 67090                       |                       |
| 9139    | 92120                       |                       |
| 9238    | 43572                       |                       |
| 9375    | 92583                       |                       |
| 9389    | 43850                       |                       |
| 9470    | 68680                       |                       |
| 9526    | 92420                       |                       |
| 44544   | G4002                       |                       |
| 44644   | G4002                       |                       |
| 1010A   | 45813                       |                       |
| 1010AD  | 45813                       |                       |
| 1010AK  | 45043                       |                       |
| 1010D   | 45812                       |                       |
| 1010K   | 45042                       |                       |
| 1010KD  | 45042                       |                       |
| 1011A   | 45833                       |                       |
| 1011AD  | 45833                       |                       |
| 1011AK  | 45073                       |                       |
| 1011AKD | 45073                       |                       |
| 1011D   | 45832                       |                       |

| VSM® PN | Grote® Form, Fit & Function | Grote® Fit & Function |
|---------|-----------------------------|-----------------------|
| 1011K   | 45832                       |                       |
| 1011KD  | 45072                       |                       |
| 1015A   | G1033                       |                       |
| 1015AC  | G1003                       |                       |
| 1015AD  | 47123                       |                       |
| 1015AK  | G1033                       |                       |
| 1015AKD | 47473                       |                       |
| 1015D   | 47122                       |                       |
| 1015K   | G1032                       |                       |
| 1015KD  | 47472                       |                       |
| 1015RC  | G1042                       |                       |
| 1030A   | 45823                       |                       |
| 1030AD  | 45823                       |                       |
| 1030D   | 45822                       |                       |
| 1035A   | G3003                       |                       |
| 1035AD  | 47113                       |                       |
| 1035AK  | G3003                       |                       |
| 1035AKD |                             | 47113 + 94100         |
| 1035K   | G3002                       |                       |
| 1035KD  |                             | 47112 + 94100         |
| 1255AX  | G4603                       |                       |
| 1255X   | G4602                       |                       |
| 1375A   | 46813                       |                       |
| 1376A   | 47183                       |                       |
| 1500A   | 46413                       |                       |
| 1500AD  | 45163                       |                       |
| 1500D   | 45162                       |                       |
| 1500W   | 60271                       |                       |
| 1505A   | G1503                       |                       |
| 1505D   | 47082                       |                       |
| 1505W   | 60421                       |                       |
| 1505WD  | 60671                       |                       |
| 1900A   | 46743                       |                       |
| 1900AD  | 46742                       |                       |
| 1900W   | 60301                       |                       |
| 1905A   | G1903                       |                       |
| 1905D   | 47092                       |                       |
| 2102A   | 46073                       |                       |
| 2105AK  | G2103                       |                       |
| 2105AKD | 49393                       |                       |
| 2105K   | G2102                       |                       |
| 2105KD  | 49392                       |                       |
| 3305A   | 49333                       |                       |
| 3305AD  | 49323                       |                       |
| 3305D   | 49322                       |                       |
| 3305G   | 60824                       |                       |
| 3305W   | 60651                       |                       |
| 3305WD  | 60721                       |                       |
| 3812LE  | G5300                       |                       |
| 3812LED | G5300                       |                       |
| 4054A   | 52923                       |                       |
| 4054AD  |                             | 52923 + 91740 + 67090 |
| 4054C   | 62171                       |                       |
| 4054CD  | 62221                       |                       |
| 4054D   | 53012                       |                       |
| 4064A   | 52923                       |                       |
| 4064AD  | 52923                       |                       |
| 4064D   | 52922                       |                       |
| 4064W   | 62171                       |                       |
| 4064WD  | 62211                       |                       |
| 420W    | 60001                       |                       |
| 44544A  | G4003                       |                       |
| 44544D  | G4012                       |                       |
| 4454A   | G4012                       |                       |
| 4454D   | 53462                       |                       |
| 44644A  |                             | G4003 + 91740 + 67090 |
| 44644RC | G4022                       |                       |
| 4464A   | G4003                       |                       |
| 4464AD  | 53253                       |                       |
| 4464D   | 53252                       |                       |
| 4464R   | G4022                       |                       |



**VSM® -TO-GROTE®  
 INTERCHANGE**

| VSM® PN | Grote® Form, Fit & Function | Grote® Fit & Function |
|---------|-----------------------------|-----------------------|
| 4464W   | 62691                       |                       |
| 4464WD  | 64971                       |                       |
| 5016LED | G5092                       |                       |
| 6054A   | 53093                       |                       |
| 6054C   | 62231                       |                       |
| 6054CD  | 62251                       |                       |
| 6054D   | 52572                       |                       |
| 6064A   | 52183                       |                       |
| 6064AD  | 52893                       |                       |
| 6064W   | 62231                       |                       |
| 6064WD  | 62231                       |                       |
| 6154A   | 52253                       |                       |
| 6154AD  | 52892                       |                       |
| 6164A   | 52193                       |                       |
| 620W    | 64931                       |                       |
| 6454A   | G6003                       |                       |
| 6454AD  | 53123                       |                       |
| 6454D   | 53122                       |                       |
| 64644AC | G6013                       |                       |
| 64644RC | G6012                       |                       |
| 6464A   | G6003                       |                       |
| 6464AD  | 53963                       |                       |
| 6464D   | 53962                       |                       |
| 6464W   | 62751                       |                       |
| 6464WD  | 62751                       |                       |
| 6554A   | 54193                       |                       |
| 6564A   | 54193                       |                       |
| 7562D   | 90941-5                     |                       |
| 9119D   | 91400                       |                       |
| 9124D   | 67000                       |                       |
| 9127D   | 91740                       |                       |
| 9128D   | 66843                       |                       |
| 9139D   | 92120                       |                       |
| 1255    | G4602                       |                       |
| 4469    |                             | 53532 + 52513         |
| 1255A   | G4603                       |                       |
| 3005RC  |                             | 45772                 |

Ford® is a registered trademark of Ford Motor Company CORPORATION DELAWARE; Kenworth® is a registered trademark of PACCAR, Inc.; Freightliner® is a registered trademark of Daimler Trucks North America, LLC; Navistar® is a registered trademark of Navistar International Corporation; Fontaine® is a registered trademark of Fontaine Truck Equipment Company; GM® is a registered trademark of General Motors LLC; Jeep® is a registered trademark of FCS US LLC; Peterbilt® is a registered trademark of PACCAR Inc DBA Peterbilt Motors Company; Chevrolet® is a registered trademark of General Motors LLC; Wrangler® is a registered trademark of FCS US LLC; GMC® is a registered trademark of General Motors LLC; Dodge® is a registered trademark of FCA US LLC; Fiat® is a registered trademark of FCA Marketing Group S.P.A.; Deutsch® is a registered trademark of TE Connectivity Corporation; Smart Alarm® is a registered trademark of Electronic Controls Company; Ray-Ban® is a registered trademark of Luxottica Group S.P.A.; Polaris® is a registered trademark of Polaris Industries; Honda® is a registered trademark of Honda Motor Company, Ltd.; Acura® is a registered trademark of Honda Motor Company, Ltd.; AMC® is a registered trademark of FCA US LLC; BMW® is a registered trademark of Bayerische Motoren Werke Aktiengesellschaft; Buick® is a registered trademark of General Motors LLC; Cadillac® is a registered trademark of General Motors LLC; Chevrolet/GMC® is a registered trademark of General Motors LLC; Chrysler® is a registered trademark of FCA US LLC; Daihatsu® is a registered trademark of Daihatsu Motor Co. Ltd.; Hyundai® is a registered trademark of Hyundai Motor Company; Kubota® is a registered trademark of Kubota Tractor Corporation; Kawasaki® is a registered trademark of Kawasaki Motors Corporation; John Deere® is a registered trademark of Deere & Company. S-Link™ is a Trademark of Star1889 Headlight & Lantern Co. Truck-Lite® is a registered trademark of TRUCK-LITE CO., LLC; Packard® is a registered trademark of DELPHI TECHNOLOGIES, INC.; Hyundai® is a registered trademark of HYUNDAI MOTOR COMPANY.; Infiniti® is a registered trademark of NISSAN JIDOSHA KABUSHIKI KAISHA.; International® is a registered trademark of International Truck Intellectual Property. Isuzu® is a registered trademark of ISUZU JIDOSHA KABUSHIKI KAISHA. Jaguar® is a registered trademark of JAGUAR LAND ROVER LIMITED. Lincoln® is a registered trademark of FORD MOTOR COMPANY.

Mazda® is a registered trademark of MAZDA MOTOR CORPORATION. Mitsubishi® is a registered trademark of MITSUBISHI JUKOGYO KABUSHIKI KAISHA. Mercury® is a registered trademark of FORD MOTOR COMPANY. Nissan® is a registered trademark of NISSAN JIDOSHA KABUSHIKI KAISHA.; Plymouth® is a registered trademark of FCA US LLC.; Pontiac® is a registered trademark of GENERAL MOTORS LLC.; Porsche® is a registered trademark of Dr. Ing. h.c. F. Porsche Aktiengesellschaft.; Renault® is a registered trademark of RENAULT s.a.s.; SAAB® is a registered trademark of SAAB AB.; Subaru® is a registered trademark of FUJII JUKOGYO KABUSHIKI KAISHA.; Suzuki® is a registered trademark of SUZUKI MOTOR CORPORATION.; Toyota® is a registered trademark of Toyota Jidosha Kabushiki Kaisha.; Yugo® is a registered trademark of OTP LLC.; Signal-Stat® is a registered trademark of TRUCK-LITE CO., LLC; Paccar® is a registered trademark of PACCAR Inc; Peterson® is a registered trademark of Peterson Manufacturing Company; Primatronics® is a registered trademark of Fleetpride, Inc.; Maxxima® is a registered trademark of PANOR CORP.; Optronics® is a registered trademark of Optronics International, LLC; VSM® is a registered trademark of VEHICLE SAFETY MANUFACTURING, LLC; Tramec Sloan® is a registered trademark of Tramec Sloan, LLC; Cole Hersee® is a registered trademark of COLE-HERSEE COMPANY; Napa® is a registered trademark of NATIONAL AUTOMOTIVE PARTS ASSOCIATION; Ecco is a registered trademark of ELECTRONIC CONTROLS COMPANY; Peugeot® is a registered trademark of AUTOMOBILES PEUGEOT société anonyme sa; Phillips® is a registered trademark of R.A. PHILLIPS INDUSTRIES, INC.; Velvac® is a registered trademark of VELVAC Inc.; 3M® is a registered trademark of 3M Company; Valox® is a registered trademark of SABIC INNOVATIVE PLASTICS IP B.V.; Tyco® is a registered trademark of Tyco International Services GmbH LIMITED LIABILITY COMPANY SWITZERLAND; Metri-Pack® is a registered trademark of Aptiv Technologies Limited COMPANY BARBADOS; Scan-Lock™ is a trademark of Whelen Engineering; Sterling®; Mack®; Volvo®; Freuhauf®; Scan-Lock®; Eagle®; Triumph®.

All product and company names are trademarks™ or registered® trademarks of their respective holders. Use of them does not imply any affiliation with or endorsement by them.

# VISIT **GROTE.COM** TO GET THE MOST UP-TO-DATE PRODUCT INFORMATION

Whether you prefer desktop, tablet, or mobile, **GROTE.COM** puts all the Grote® lighting and electrical accessory information at your fingertips, wherever you may be.



## **GROTE.COM – THE ULTIMATE REFERENCE!**

- **HIGH-RESOLUTION IMAGERY**
- **UP-TO-DATE STATS AND INFORMATION**
- **UNIQUE 360° VIEWS OF MANY PRODUCTS**
- **LATEST PRODUCT RELEASES**



**IMPORTANT NOTE:** Every lamp, reflex reflector, and conspicuity treatment must be permanently attached in the location specified below and must comply with all applicable requirements prescribed for it by FMVSS/CMVSS 108. The face of any device on the front/rear and sides should be, respectively perpendicular and parallel to the vehicle's centerline, unless it is photo-metrically certified at installation angle. No part of the vehicle shall prevent any device from meeting its prescribed requirements unless an auxiliary device meeting all prescribed requirements is installed.

**IN CANADA:** Manufacturers and importers of vehicles must have the proper certification test records demonstrating compliance of lighting components with all prescribed requirements.

**BASIC EQUIPMENT REQUIRED ON ALL TRAILERS**

| DESCRIPTION |   |                       |  | MANDATORY REQUIREMENTS |              |   |   |
|-------------|---|-----------------------|--|------------------------|--------------|---|---|
| Area        | Equipment   | SAE Lens Coding       | Functional Purpose   | Quantity               | Color        | Location  | Height mm(in.) from the ground                            |
| 1           | Tail Lamps  | (T)                   | Indicate vehicle's presence and width  | Minimum 2              | Red          | On the rear - symmetrical as far apart as practicable                 | 860-1830 (15-73)  |
|             | Stop Lamps  | (S)                   | Indicate braking   | Minimum 2              | Red          | On the rear - symmetrical as far apart as practicable                 | 360-1830 (15-73)  |
|             | Rear Turn Signal Lamps  | (R)                   | Indicate direction of turn   | Minimum 2              | Red or Amber | On the rear - symmetrical as far apart as practicable                 | 360-2110 (15-83)  |
|             | Rear Reflex Reflectors  | (A)                   | Indicate vehicle's presence and width  | Minimum 2              | Red          | On the rear - symmetrical as far apart as practicable facing rearward | 860-1830 (15-80)  |
| 2           | License Plate Lamp(s)   | (L)                   | Illuminates license plate  | Minimum 1              | White        | On the rear - above or at the sides of license plate                  | No requirement  |
| 3           | Rear Side Marker Lamps<br><small>*photo-metrically certified at installation angle</small>    | (PS, PC* or FS, PC2*) | Front and rear side marker lamps / side reflex reflectors indicate vehicle's presence and length | Minimum 2              | Red          | Each side at rear as far back as practicable                          | 380-1530 (15-80) no max. for veh. under 2020mm (80") wide |
|             | Rear Side Reflex Reflectors   | (A)                   |  | Minimum 2              | Red          | Each side at rear as far back as practicable facing outward           | 380-1530 (15-80)  |
| 4           | a Front Side Marker Lamps<br><small>*photo-metrically certified at installation angle</small> | (PS, PC* or FS, PC2*) | Front and rear side marker lamps / side reflex reflectors indicate vehicle's presence and length | Minimum 2              | Amber        | Each side at front as far forward as practicable                      | 380 (15) minimum  |
|             | b Front Side Reflex Reflectors  | (A)                   |  | Minimum 2              | Amber        | Each side at front as far forward as practicable facing inward        | 380-1530 (15-80)  |

**ADDITIONAL EQUIPMENT FOR TRAILERS EXCEEDING THE FOLLOWING PARAMETERS**  
Length 9.1m (30 ft.) or longer

| DESCRIPTION |  |                       |                                      | MANDATORY REQUIREMENTS |       |                                       |                                |
|-------------|--|-----------------------|--------------------------------------|------------------------|-------|---------------------------------------|--------------------------------|
| Area        | Equipment  | SAE Lens Coding       | Functional Purpose                   | Quantity               | Color | Location                              | Height mm(in.) from the ground |
| 5           | a Intermediate Side Marker Lamps<br><small>*photo-metrically certified at installation angle</small> | (PS, PS, PC* or PC2*) | Indicates presence of a long vehicle | Minimum 2              | Amber | Each side rear center facing sideward | 380 (15) minimum               |
|             | b Intermediate Side Reflex Reflectors  | (A)                   |                                      | Minimum 2              | Amber | Each side rear center facing sideward | 380-1530 (15-80)               |

**Width 2032mm (80 in.) or wider**

| DESCRIPTION |   |                       |  | MANDATORY REQUIREMENTS |       |  |   |
|-------------|---|-----------------------|--|------------------------|-------|--|---|
| Area        | Equipment   | SAE Lens Coding       | Functional Purpose   | Quantity               | Color | Location   | Height  |
| 6           | Rear Clearance Lamps<br><small>*photo-metrically certified at installation angle</small>  | (PS, PC* or FS, PC2*) | Show vehicle's width<br><small>MAY NOT be combined with tail lamps</small> | Minimum 2              | Red   | At widest point - symmetrical on the rear or near the rear facing rearward                     | As high as practicable may be lower only if 10 lamps are at the top |
| 7           | Rear Identification (ID) Lamps  | (F2 or F3)            | Indicate presence of a wide vehicle  | Exactly 1              | Red   | On the rear - center horizontally spaced 150mm (6 in.) to 200mm (12 in.) apart facing rearward | At the top - may be lower if door/wheel narrower than 25mm          |
| 8           | Front Clearance Lamps<br><small>*photo-metrically certified at installation angle</small> | (FS, PC* or FS, PC2*) | Show vehicle's width   | Minimum 2              | Amber | At widest point - symmetrical on the front or near the front facing forward                    | As high as practicable  |

**Width 2032mm (80 in.) or wider AND GVWR 4536 kg (10,000 lb.) or more**

| DESCRIPTION |                          | MANDATORY REQUIREMENTS              |                                      |                         |   |  |   |
|-------------|--------------------------|-------------------------------------|--------------------------------------|-------------------------|---|--|---|
| Area        | Conspicuity Treatment    | DOT Coding                          | Quantity                             | Color                   | Location  | Height   | Options   |
| 9           | Rear Upper Body Markings | DOT-C<br>DOT-C3<br>DOT-C3<br>DOT-C4 | Exactly 2 pairs of 300mm long strips | White                   | On the rear upper corners facing rearward   | At the top   | Reflex reflectors may not be required if they are replaced in their required location with conspicuity treatment              |
| 10          | Bumper Bar Marking       |                                     | Continuous                           | Red/White               | On the rear bumper bar's horizontal element full width - facing rearward  | No requirement   |   |
| 11          | Rear Lower Body Marking  |                                     | Continuous                           | Red/White (see options) | On the rear full width of the vehicle facing rearward   | As horizontal or practicable and as close as practicable to the range of 375 to 1525mm from the ground | Optional in Canada: Rear lower body and side conspicuity treatment may also be solid white, solid yellow, or white and yellow |
| 12          | Side Marking             |                                     | (see location)                       | Red/White (see options) | Each side - facing sideward continuous, or evenly spaced over maximum of 50% of length starts and ends as close to the front and rear of the vehicle as practicable | As horizontal as practicable and as close as practicable to the range of 375 to 1525mm from the ground |   |

**NOTE:** The edge of red conspicuity tape shall not be closer than 75 mm to the edge of any amber lamp and the edge of white conspicuity tape shall not be closer than 75 mm to the edge of any lamp

For more information contact: Transport Canada: Motor Vehicle Safety Enforcement Branch Attention: Compliance Engineering Fax: 613-998-4831  
National Highway Traffic Safety Administration: Office of Safety Performance Standards Attention: Richard Van Kesterine Fax: 202-366-4329





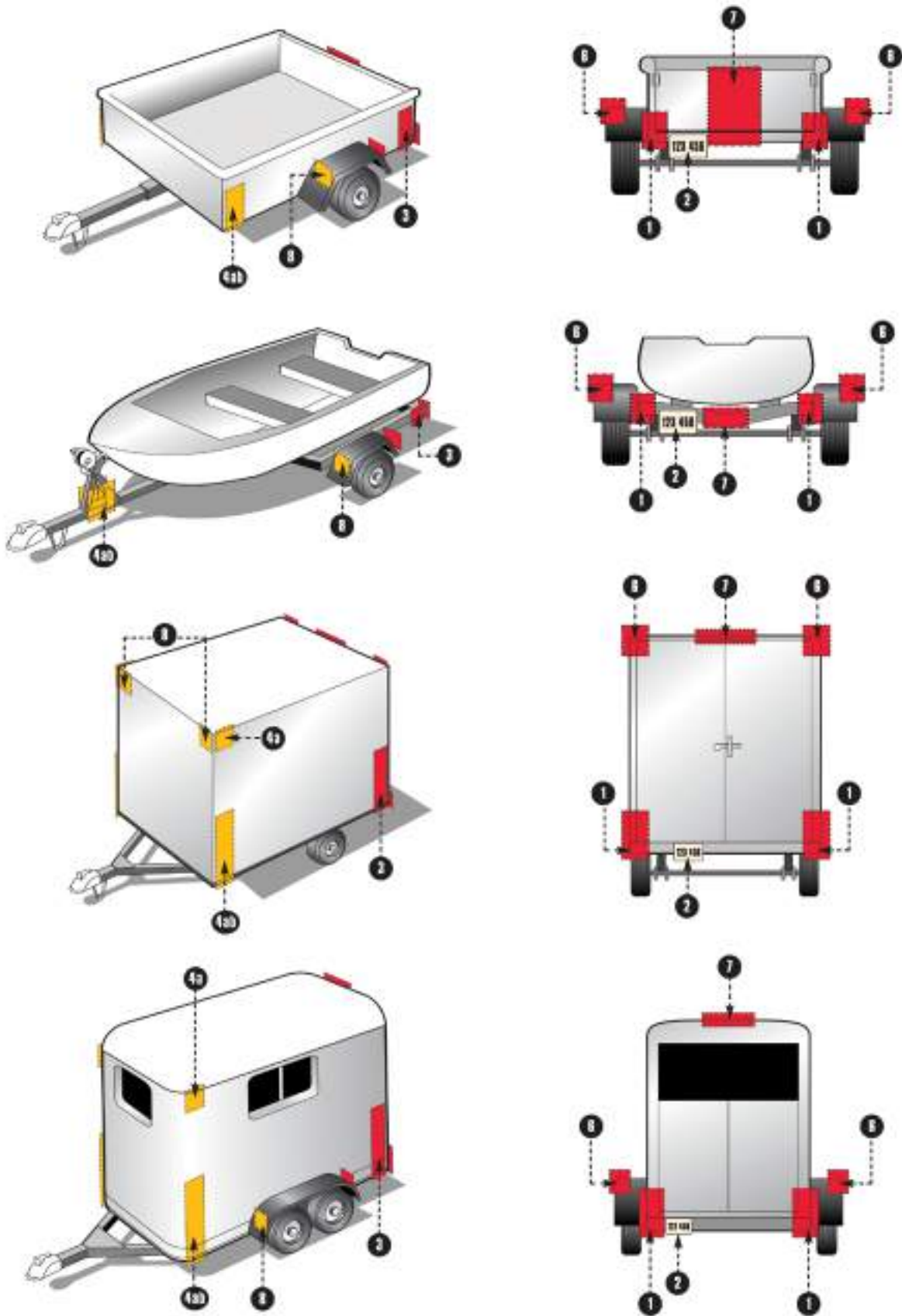



**IMPORTANT NOTE:** Every lamp, reflex reflector, and conspicuity treatment must be permanently attached in the location specified below and must comply with all applicable requirements prescribed for it by FMVSS/CMVSS 108. The face of any device on the front/rear and sides should be, respectively perpendicular and parallel to the vehicle's centerline, unless it is photometrically certified at installation angle. No part of the vehicle shall prevent any device from meeting its prescribed requirements unless an auxiliary device meeting all prescribed requirements is installed.

**IN CANADA:** Manufacturers and importers of vehicles must have the proper certification test records demonstrating compliance of lighting components with all prescribed requirements.

**BASIC EQUIPMENT REQUIRED ON ALL TRUCKS, BUSES & MPVs**

| DESCRIPTION |   |                       |  | MANDATORY REQUIREMENTS |                |  |  |
|-------------|---|-----------------------|--|------------------------|----------------|--|--|
| Area        | Equipment   | SAE Lamps Coding      | Functional Purpose   | Quantity               | Color          | Location   | Height (min.) from the ground  |
| 1           | Headlamps - Lower Beam  | (H, HR)               | Forward road illumination  | Minimum 2              | White          | On the front - symmetrical as far apart as practicable   | 660-1370 (22-54)   |
|             | US requires "DOT" lettering on lens<br>Canada - light source code required on lens  |                       |  |                        |                | If 4 lamp system - inboard or above upper beams  |  |
|             | Headlamps - Upper Beam  | (H, HR)               | Forward road illumination  | Minimum 2              | White          | On the front - symmetrical as far apart as practicable   | 660-1370 (22-54)   |
|             | US requires "DOT" lettering on lens<br>Canada - light source code required on lens  |                       |  |                        |                | If 4 lamp system - inboard or below lower beams  |  |
|             | Parking Lamps<br>Vehicle less than 3032mm wide  | (P)                   | Indicate parked vehicle  | Minimum 2              | White or amber | On the front - symmetrical as far apart as practicable   | 360-1830 (15-72)   |
|             | Daytime Running Lamps (DRL)<br>Canada - required / US - option<br>US requires "DRL" lettering on lens if not headlamp                     | (YZ)                  | Indicate in use vehicle  | Minimum 2              | White or amber | On the front - symmetrical as far apart as practicable   | 330 (15) min. Max. depends on type of DRL                                |
|             | Front Turn Signal<br>Hazard Warning Lamps   | (T)                   | Indicate direction of turn/identify disabled vehicle   | Minimum 2              | Amber          | On the front - symmetrical as far apart as practicable   | 360-2110 (15-83)   |
| 2           | Front Clearance Lamps<br>Vehicle 3032mm wide or wider<br>Photometrically certified at installation angle                                  | (P2, PC* or P3, PC2*) | Show vehicle's width   | Minimum 2              | Amber          | At widest point - symmetrical on the front or rear the front facing forward                    | As high as practicable   |
|             |   |                       |  |                        |                |  |  |
| 3           | Front Identification Lamps (ID)<br>Vehicle 3032mm wide or wider   | (P2 or P3)            | Indicate presence of a side vehicle  | Exactly 3              | Amber          | On the front - center horizontally spaced 150mm (6 in.) to 300mm (12 in.) apart                | As high as practicable or on top of the cab                              |
|             |   |                       |  |                        |                |  |  |
| 4           | Front Side Marker Lamps<br>Photometrically certified at installation angle  | (PC, PC* P3, PC2*)    | Front and rear side marker lamps / side reflex reflectors indicate vehicle's presence and length | Minimum 2              | Amber          | Each side at front as far forward as practicable   | 390 (15) minimum   |
|             | Front Side Reflex Reflectors  | (A)                   |  | Minimum 2              | Amber          | Each side at front as far forward as practicable facing sideward                               | 360-1530 (15-60)   |
| 5           | Rear Side Marker Lamps**<br>Photometrically certified at installation angle   | (P2, PC* or P3, PC2*) | Rear and front side marker lamps / side reflex reflectors indicate vehicle's presence and length | Minimum 2              | Red            | Each side at rear as far back as practicable   | 390 (15) minimum   |
|             | Rear Side Reflex Reflectors**<br>Not required on Truck Tractors   | (A)                   |  | Minimum 2              | Red            | Each side at rear as far back as practicable facing sideward                                   | 360-1530 (15-60)   |
| 6           | Rear Clearance Lamps<br>Vehicle 3032mm wide or wider<br>Not required on Truck Tractors<br>Photometrically certified at installation angle | (P2, PC* or P3, PC2*) | Show vehicle's width<br>MAY NOT be combined with tail lamps                                      | Minimum 2              | Red            | At widest point - symmetrical on the rear or near the rear facing rearward                     | As high as practicable may be lower only if rear ID lamps are on the top |
|             |   |                       |  |                        |                |  |  |
| 7           | Rear Identification (ID) Lamps<br>Vehicle 3032mm wide or wider<br>Not required on Truck Tractors  | (P2 or P3)            | Indicate presence of a side vehicle  | Exactly 3              | Red            | On the rear - center horizontally spaced 150mm (6 in.) to 300mm (12 in.) apart facing rearward | At the top may be lower if over headboard narrower than 300mm            |
|             |   |                       |  |                        |                |  |  |
| 8           | Tail Lamps  | (T)                   | Indicate vehicle's presence and width  | Minimum 2              | Red            | On the rear - symmetrical as far apart as practicable  | 360-1830 (15-72)   |
|             | Stop Lamps  | (S)                   | Indicate braking   | Minimum 2              | Red            | On the rear - symmetrical as far apart as practicable  | 360-1830 (15-72)   |
|             | Rear Turn Signal<br>Hazard Warning Lamps  | (T)                   | Indicate direction of turn/identify disabled vehicle   | Minimum 2              | Red or amber   | On the rear - symmetrical as far apart as practicable  | 300-2110 (15-83)   |
|             | Rear Reflex Reflectors  | (A)                   | Show vehicle's presence and width  | Minimum 2              | Red            | On the rear - symmetrical as far apart as practicable  | 360-1530 (15-60)   |
| 9           | Backup Lamp   | (B)                   | Illuminate ground behind the vehicle and alert road users  | Minimum 1              | White          | Rear   | No requirement   |
| 10          | License Plate Lamp(s)   | (L)                   | Illuminate license plate   | Minimum 1              | White          | On the rear - above or at the sides of license plate   | No requirement   |
| 11          | Center High Mounted Stop Lamp<br>Vehicle less than 3032mm wide and 455kg  | (U3)                  | Indicate braking   | 1                      | Red            | On the rear - centerline of the vehicle  | 390 (15) minimum   |

**ADDITIONAL EQUIPMENT FOR SPECIFIC VEHICLES  
VEHICLES 9.1m (30 ft.) LONG OR LONGER**

| DESCRIPTION |                                     |                  |                                     | MANDATORY REQUIREMENTS |       |                                       |                               |
|-------------|-------------------------------------|------------------|-------------------------------------|------------------------|-------|---------------------------------------|-------------------------------|
| Area        | Equipment                           | SAE Lamps Coding | Functional Purpose                  | Quantity               | Color | Location                              | Height (min.) from the ground |
| 12          | Intermediate Side Marker Lamps      | (P2 or P3)       | Indicate presence of a long vehicle | Minimum 2              | Amber | Each side near center                 | 390 (15) minimum              |
|             | Intermediate Side Reflex Reflectors | (A)              | Indicate presence of a long vehicle | Minimum 2              | Amber | Each side near center facing sideward | 360-1530 (15-60)              |

**Truck Tractors**

| DESCRIPTION |                          | MANDATORY REQUIREMENTS |                                       |               |  |   |   |
|-------------|--------------------------|------------------------|---------------------------------------|---------------|--|---|---|
| Area        | Conspicuity Treatment    | DOT Coding             | Quantity                              | Color         | Location   | Height  | Options   |
| 13          | Rear Upper Body Markings | DOT-C<br>DOT-C3        | Exactly 2 pairs of 300mm long strips  | White         | Rear upper corners of cab facing rearward  | As high as practicable excluding fenders                                |   |
|             | Rear Marking             | DOT-C3<br>DOT-C4       | Exactly 2 sections of min. 600mm each | Red/<br>White | Rear - facing rearward - on fenders, on mud flap backs, or within 300mm below the top of mud flaps | As horizontal as practicable and not higher than 1525mm from the ground | If mud flaps not used on the cab or have mounted brackets |

**NOTE:** The edge of red conspicuity tape shall not be closer than 75 mm to the edge of any amber lamp and the edge of white conspicuity tape shall not be closer than 75 mm to the edge of any lamp.

For more information contact:

National Highway Traffic Safety Administration: Office of Safety Performance Standards  
Transport Canada: Motor Vehicle Safety Enforcement Branch

Attention: Richard Van Iderstine  
Attention: Compliance Engineering

Fax: 302-366-4329  
Fax: 613-998-4831

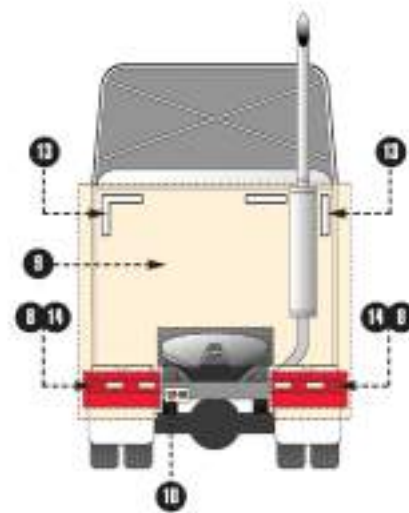
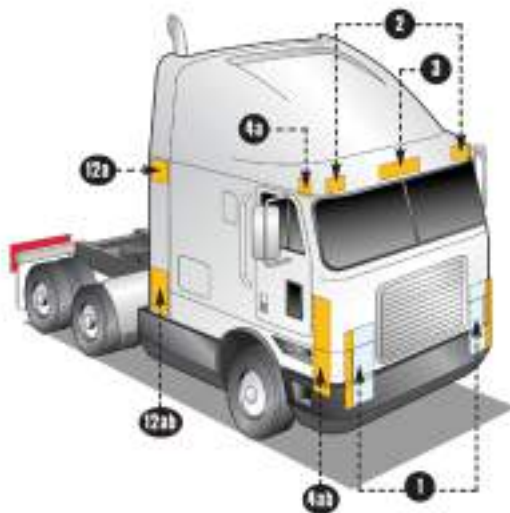
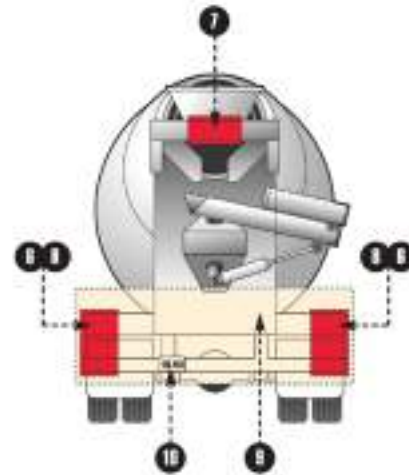
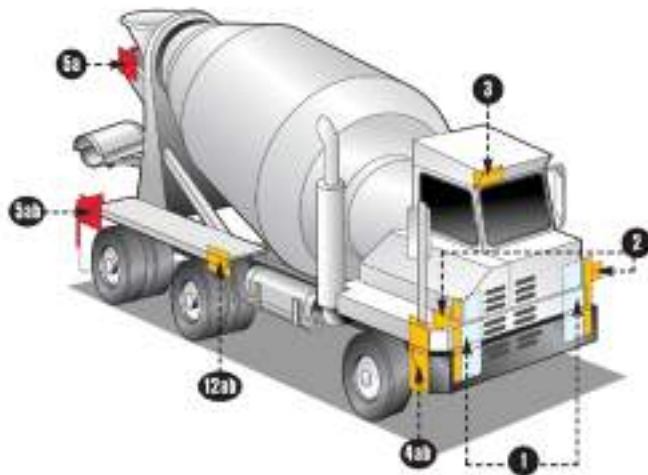
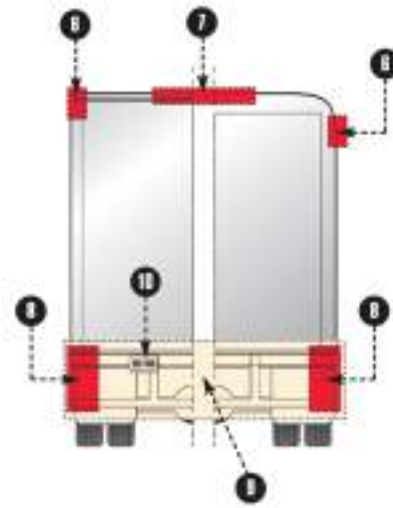
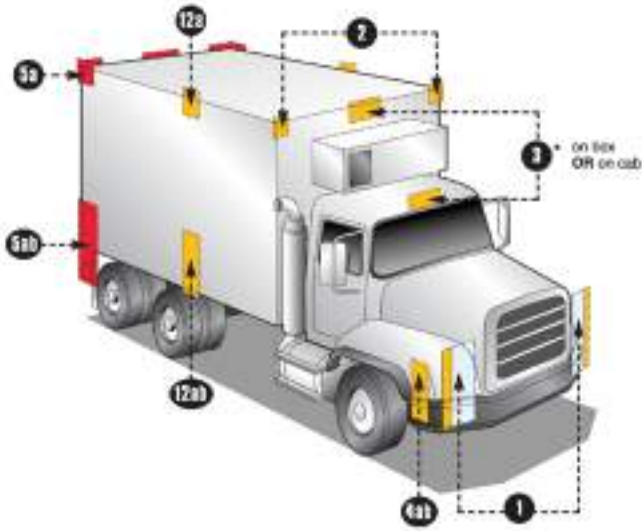



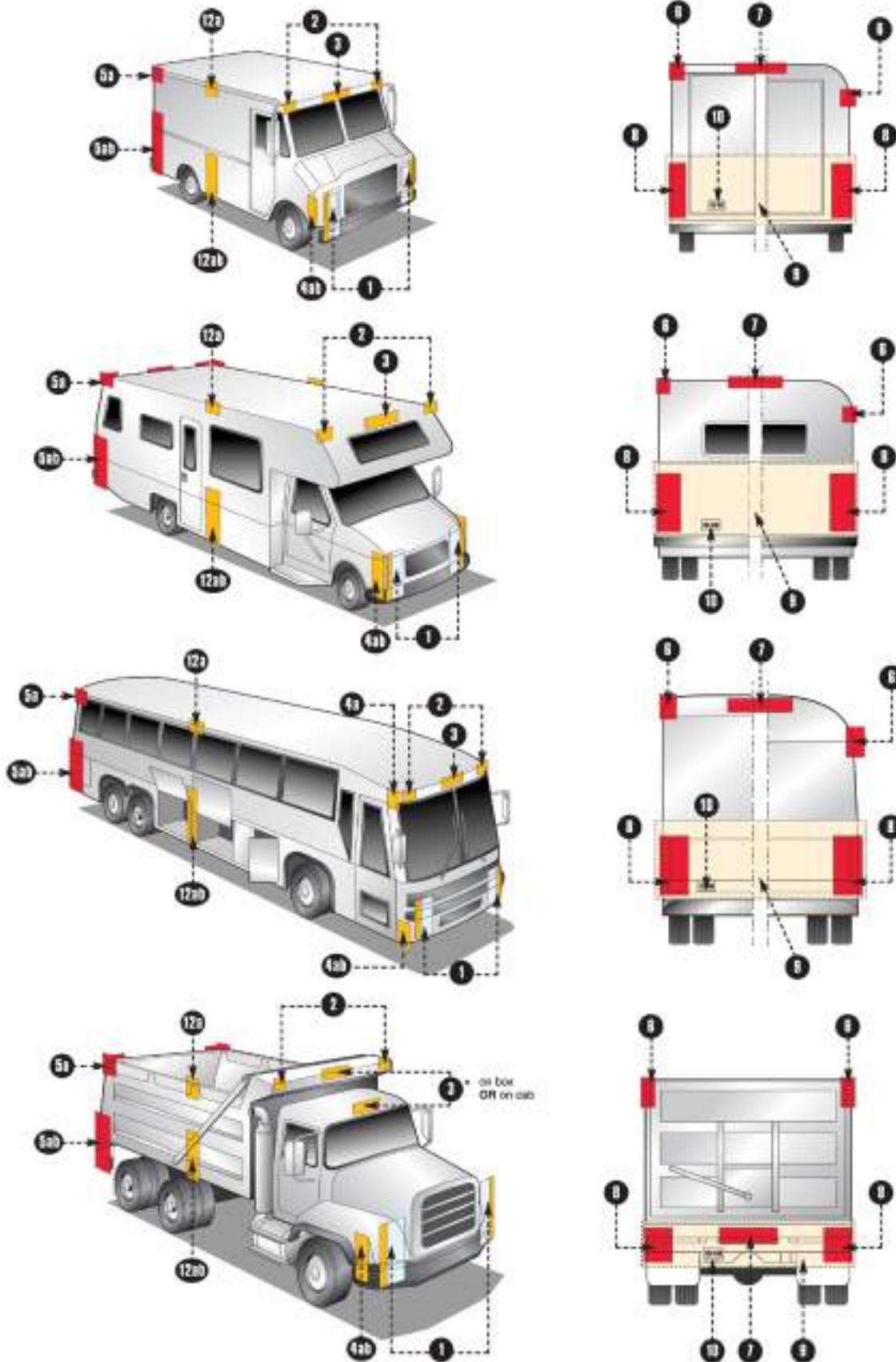

## 9 COMMON CAUSES OF FAILURE IN TRUCK WIRING AND LIGHTING



### VIBRATION

Broken lamp filaments are one of the most common problems caused by vibration, but they also can lead to the abrasion of mating surfaces, which cause connectors and splices to fail.

To minimize vibration problems, make certain that all wires and connectors are secured appropriately. Always secure the wiring as it exits the connector. Use cushioned mountings for lamps in applications where vibration is excessive.

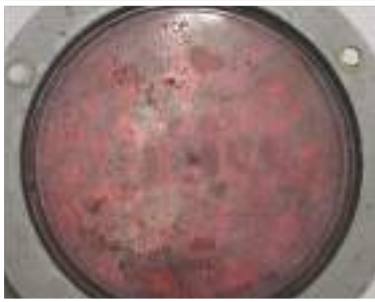

### MOISTURE AND CORROSION

Condensed water droplets inside a lens or corrosion around a lamp socket are sure signs that moisture has penetrated the system.

Water can enter the system through ineffective wire seals, unprotected splices, unsealed crimps and connectors and non-mating seals.

When making repairs, don't replace a sealed system with unsealed components. Make certain that connector seals are in place and undamaged. Inspect them carefully for cuts, tears and punctures.

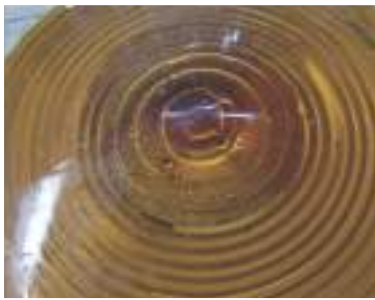

### CHEMICAL DAMAGE

Continuous exposure to many of the common chemicals found in and around trucks can cause plastics to swell, crack, soften or otherwise become degraded. Diesel fuel and hot engine oil are the main culprits.

To minimize the effects of chemicals, inspect the wiring for signs of degradation. If it is occurring in an area that is generally free of contamination, check for leaky hoses, gaskets or fittings and repair if damaged or leaking.

To avoid damage from chemicals, don't run wiring in areas where the chance for continuous exposure is likely, such as under fuel lines and filters.



### ABRASION

Abrasion occurs when wires or wire wraps are allowed to run against frame members or other abrasive surfaces. Once the insulation is worn away, bare conductors may contact a ground surface and create a grounded circuit. Or, it could cause wear to the point of fracture resulting in an open circuit.

Using the proper routing and coverings will help to prevent wear areas and abrasive damage.

Worn coverings such as loom, convoluted tubing or spiral wrap should be replaced if they are no longer providing sufficient protection for the wires inside.



**EXTREME TEMPERATURES**

A variety of conditions lead to extreme temperature build-up that can damage lighting and wiring. These include leaving a trailer's tail lights on when the trailer is backed up to a dock and airflow around the lights is prohibited.

When lights have been damaged from heat buildup, the lenses are often bubbled and misshapen. Where extreme temperatures can't be avoided, special heat-resistant wires and materials should be used.



**IMPACT**

Lighting and wiring must be protected from the impact of rocks, gravel and other road debris. A major impact can cause enough damage to require extensive repairs. Smaller, more frequent impacts over time may deliver equally extensive damage. Such damage can cause problems although the wires are contained in a loom or other covering. During inspection, always check for damage from impacts and replace any wiring or lights that appear to be damaged. Make certain that the replacement parts are equivalent to or better than the original.



**FLEXING**

Wiring in a truck often must make sharp turns around corners, and can be subjected to constant flexing where doors or hoods are opened and closed repeatedly.

To prevent wire damage from repeated flexing, avoid tight radius turns. Make sure that the wire is not snagged or stressed at its maximum extension. Also, make certain that the wire moves smoothly through its flexing cycle and doesn't rub or scrape against adjacent components.



**TENSILE LOADS**

Wiring should not be considered an appropriate load-bearing component. It's easy to exceed the designed load limit by inadvertently installing wires under tension or snagging a section of wire on one of the moving parts. Using a wire bundle as a handhold or step can destroy the integrity of the conductor and its connections. So can the weight of accumulated ice, snow, mud and other materials.

Each of these points must be considered carefully when routing wires in a wiring harness.



**GRIT AND SAND**

Accumulation of abrasive materials can lead to damage, especially when combined with vibration. If gritty materials enter connections, they can accelerate the wear on contact points, causing interruption of the circuit and failure of devices. Sand and grit also can attract and hold moisture, creating conditions conducive to corrosion. In some cases, sand and grit may work their way inside protective coverings and abrade the insulation of wires running through them.

One of the ways of reducing sand and grit buildup is to eliminate abrasive materials in the areas where wiring is present. Another way is to seal openings on protective coverings to keep gritty materials from entering.

For more information, visit [www.grote.com](http://www.grote.com)





## ***A FAMILY'S MULTI-GENERATIONAL COMMITMENT TO THE VEHICLE AND TRANSPORTATION LIGHTING INDUSTRY.***



**William D. Grote, Founder, Grote® Industries, 1901**

the lighting industry in a different context from those who simply find themselves working in the lighting business.

Grote® Industries is a family-owned business, just like many of the distributors, fleets, and OEMs we serve. Like a number of our customers, we're proud of our family's multi-generational commitment to the transportation industry that reaches back more than a century. We're thankful for the visionary legacy of our predecessors and because of it, we can't help but see the past, present and future of

Founded on the principles of solid customer relationships, continuous innovation and exceptional product performance, Grote® is committed to propelling itself and its industry, forward, with inventive products and challenging ideas.

As a corporation, our family's culture extends to our entire organization, around the globe and particularly to our customer-facing staff. Grote® is not sales oriented, we're not engineering oriented – we're relationship oriented and we're working hard every day to uphold our reputation and continue to earn your trust.

The Grote family has played a prominent role in shaping the vehicle lighting industry. We are deeply and personally engaged today, as we will be in the future, to make the kind of brave choices and bold decisions that will help move the vehicle lighting industry ahead and into an even brighter tomorrow.



**Grote Industries, Inc.**  
2600 Lanier Drive  
Madison, Indiana 47250  
USA  
Phone: 812-273-1296  
Phone: 800-628-0809  
Email: [safety@grote.com](mailto:safety@grote.com)



**Grote Industries, Co.**  
230 Travail Road  
Markham, Ontario L3S 3J1  
Canada  
Phone: 905-209-9744  
Phone: 800-268-5612  
Email: [canada@grote.com](mailto:canada@grote.com)



**Grote Comercial Latinoamérica S. de R.L. de C.V.**  
Ave. Arco Vial #201 Int 5  
Col. Parque Industrial Monterrey  
Código Postal 66603  
Apodaca, Nuevo León CP 66603  
México  
Phone: +(52) 818262-4413  
Email: [mexico@grote.com](mailto:mexico@grote.com)



**Grote Industries Europe GmbH**  
William-Grote-Weg 1  
D-94327 Bogen  
Germany  
Phone: +49 9422 40331-0  
Email: [europe@grote.com](mailto:europe@grote.com)



**Grote Shanghai Vehicle Lighting Systems Co., Ltd.**  
907A, 665 North Songwei Road,  
Songjiang District, Shanghai  
Phone: +86.21.5774.9633  
Email: [asia@grote.com](mailto:asia@grote.com)