



TECH INTERNATIONAL
TIRE REPAIR CATALOG

www.techtirerepairs.com



TRUST TECH The World Leader in Tire Repair



Table of Contents

TIRE REPAIR PRODUCTS & REPAIR CHARTS Pages 3 – 25

Uni-Seal Ultra Repairs	3 – 4
Uni-Seal 2-piece Stems & Repairs	5 – 7
Centech Radial Repairs for Shoulder Injuries	6
Radial Section Repairs	8 – 10
Bias Ply Tire Repairs	11 – 13
Radial OTR Repairs	14 – 18
Tech Off Road (TOR) Bias Repairs	19 – 21
Repair Rubber and Chemicals	22 – 24
2-Way Tube Repairs & All-Purpose Repairs	25

NAILHOLE INSERTS & REPAIR KITS Pages 26 – 28

Permacure Repairs & Kits	26
Flow-Seal Inserts & Self-Vulcanizing Repairs	27
Repair Kits	28

CABINETS & REPAIR TOOLS Pages 29 – 31, 113

Cabinets & Tool Stations	29
Hand Tools and Knives, Extruder Guns & Branding Irons	30 – 31
Regroovers, Blades & Accessories	113

Markal PRODUCT PAGES Pages 32 – 33

Tire Inspection & Marking Tools	32 – 33
Anti-Seize Compound	33

SAFETY, PROTECTION & HAND CLEANING PRODUCTS Page 34

AIR TOOLS & ACCESSORIES Pages 35 – 41

Drills, Buffers & Air Hammers	35
Cutters, Burrs, Grinding Stones, Wheels & Rasps	36 – 39, 41
Wire Brushes, Buffing Stones	40
Gouges & Cut-Off Wheels	41

MONAFLEX VULCANIZING EQUIPMENT & SPOTTERS Pages 42 – 47

TIRE & WHEEL SERVICE LUBRICANTS Pages 48 – 49

TIRE IDENTIFICATION Page 50

Radio Frequency Identification Data Tags (RFID)	50
Tire Identification Logos	50

TIRE SPREADERS Page 51

TIRE BALANCING & SEALANT PRODUCTS **Pages 52 – 53**

Balance Pads, Tools & Chemicals	52
Balancing Compound & Tire Sealant	53

TPMS SOLUTIONS **Pages 54 – 57**

VALVES & VALVE HARDWARE **Pages 58 – 73**

AIR SERVICE PRODUCTS **Pages 74 – 78**

Gauges	74
Automatic Tire Inflators	76
Chucks & Chuck Repair Kits	77
Air Couplers	78

IMPACT WRENCHES & SOCKETS **Pages 79 – 84**

WHEEL SERVICE PRODUCTS **Pages 85 – 87**

Fasteners	85
Stud Cleaners , Nut Wrenches & Wheel Protectors	86 – 87

TIRE & RIM SERVICE PRODUCTS **Pages 88 – 98**

OTR Bead Breakers & Tire Service Products	88 – 89
Ken-Tool Tire & Rim Service Products	90 – 93
Gaither Tire Inflation & Tire Changing Products	94, 95, 98
Jacks & Lifting Products	96 – 97

WHEEL WEIGHTS, KITS & TOOLS **Pages 99 – 105**

AUTOMOTIVE SERVICE PRODUCTS **Pages 106 – 112**

Tire Changer Products & Supplies	106 – 108
Wheel Balancer Products	109
Brake Lathe Products	109 – 110
Lift Pads	110
Lug Nuts, Cable Ties & Spare Tire Keys	111
Abrasives	112

PRODUCT INDEX **Pages 114 – 119**

TRAINING MATERIALS & INFORMATION **Pages 120 – 122**



Chart Directory

Headquartered in Johnstown, Ohio and founded in 1939, Tech International is the world's leading producer of tire and tube repairs and wheel service solutions.

Today, Tech markets products into more than 110 countries throughout the world. In addition to its own line of quality products, Tech offers a vast selection of tools, service items and equipment from industry-leading manufacturers. The company is recognized as one of the top exporters in the United States and has received numerous export awards from the U.S. Chamber of Commerce, and the Ohio Department of Commerce. Tech has also been honored by receiving both the U.S. Presidential "E-Star" Awards for excellence in exporting.

REPAIR CHARTS Page

AX Aramid Reinforced Radial OTR Repair Chart	18
Bias 2-Piece Nail Hole Repair Limitations	7
BP Bias Repair Charts	13
Centech & Thermacure Radial Repair Charts	10
Centech Aramid Reinforced Radial OTR Repair Charts	15
Centech OTR Repair Recommendations - Chemical, Thermacure, Cloth Backed and Heat Cure	14
OTR Vulcanizing System Radial/Bias Ply Application Chart	43
Radial 2-piece Nail Hole Repair Limitations	7
Tech AX Severe Service Radial Repairs	16
Tech Bias Skidder Tire Repair Chart	12
Tech Off Road (TOR) & Bias Skidder Repair Chart	21
Tech Off Road (TOR) Bias OTR Repairs	20
Tech Radial OTR Repair Chart Centech Aramid Reinforced Repairs	17
Tech Uni-Seal Ultra, Uni-Seal Ultra Max & Bias Uni-Seal Repair Limitations Chart for Radial and Bias Crown Injuries	4



TECH Uni-Seal Ultra Repairs

Tech Uni-Seal Ultra one-piece repair units provide a simple, quick, and safe method to properly repair radial and bias tires. Tech Uni-Seal Ultras have passed the most stringent tire test standards in the world, including the US FMVSS139 New Tire Endurance Test. These repairs meet or exceed international tire industry guidelines for proper puncture repair, such as the ECE 108 & 109 Regulations.

Tires repaired with Uni-Seal Ultras are permanently filled by the stem and strengthened by the thick, non-fabric-reinforced rubber cap. The stem and cap of the repair are sealed and vulcanized to the tire with Tech's thick chemical cushion gum. The 290UL (UL10N) is an excellent repair for self-sealing truck tires produced with sealant beneath the inner liner.

Refer to Tech How-To-Repair Manual RM-4 or Repair Video RDVD1 for installation procedures and limitations.



Proper tire repair.



Improper tire repair.

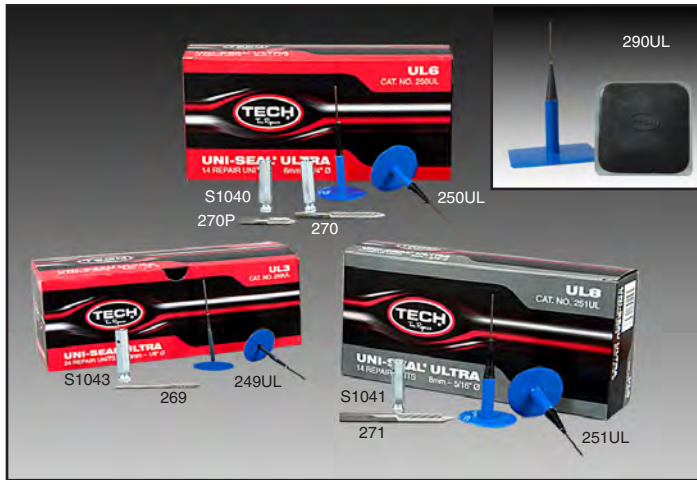

UNI-SEAL ULTRA REPAIRS FOR RADIAL AND BIAS TIRES

Cat. No.	Description	Prepared Injury Size	Box Qty.
249UL	UL3 UNI-SEAL ULTRA	3mm, 1/8"	24
250UL	UL6 UNI-SEAL ULTRA	6mm, 1/4"	14
250UL/24	UL6 UNI-SEAL ULTRA	6mm, 1/4"	24
251UL	UL8 UNI-SEAL ULTRA	8mm, 5/16"	14
251UL/24	UL8 UNI-SEAL ULTRA	8mm, 5/16"	24
290UL	UL10N NON-FABRIC-REINFORCED UNI-SEAL ULTRA	10mm, 3/8"	10
269	CC3 CARBIDE CUTTER	3mm, 1/8"	1
270	CC6 CARBIDE CUTTER	6mm, 1/4"	1
270P	CC6P CARBIDE CUTTER for passenger tires	6mm, 1/4"	1
271	CC8 CARBIDE CUTTER	8mm, 5/16"	1
271/38	CC10 CARBIDE CUTTER	10mm, 3/8"	1
S1043	QUICK CHANGE ADAPTOR for CC3		1
S1040	QUICK CHANGE ADAPTOR for CC6, CC6P		1
S1041	QUICK CHANGE ADAPTOR for CC8		1
911	2mm ALLEN WRENCH for small QC adaptors		1



TECH Uni-Seal Ultra Max Repairs

Tech Uni-Seal Ultra Max one-piece repair units provide a simple, quick, and safe method to properly repair commercial truck tires, agricultural tires, industrial and small OTR tires. Tech Uni-Seal Ultra Max repairs are produced with cross-weave reinforcement for radial or bias tires, a lead wire molded in the stem for quick installation, and Tech's thick chemical cushion gum on the stem and cap for permanent vulcanization to the tire. These repairs meet or exceed international tire industry guidelines for proper puncture repair.



UNI-SEAL ULTRA MAX REPAIRS FOR RADIAL AND BIAS TIRES

Cat. No.	Description	Prepared Injury Size	Box Qty.
291UL	UL10 UNI-SEAL ULTRA MAX	10mm, 3/8"	10
292UL	UL13 UNI-SEAL ULTRA MAX	13mm, 1/2"	10
271/38	CC10 CARBIDE CUTTER	10mm, 3/8"	1
272	CC13 CARBIDE CUTTER	13mm, 1/2"	1
S1041/38	QUICK CHANGE ADAPTOR for CC10 & CC13		1
912	3mm ALLEN WRENCH for S1041/38 QC adaptor (not shown)		1

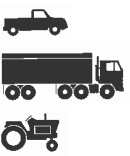

TECH Uni-Seal Repairs for Bias Tires

Tech Bias Uni-Seals provide a simple, safe, permanent method to properly repair 1/2", 13mm and 3/4", 20mm injuries in bias truck, agricultural, industrial and small OTR tires. The oversized stem fills the injury while the fabric reinforced cap restores the integrity to the tire. Both the stem and cap permanently vulcanize to the tire with Tech's thick chemical cushion gum.

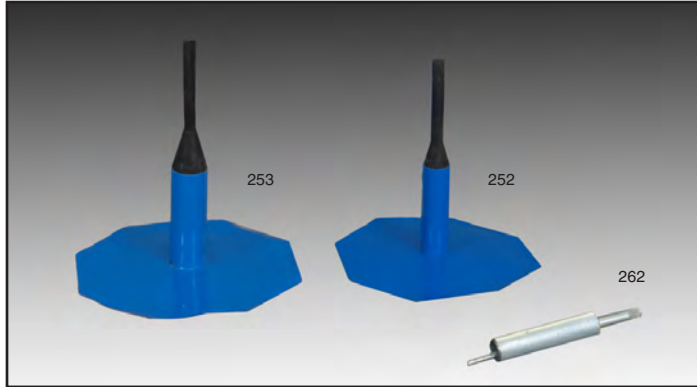

UNI-SEAL BIAS REPAIRS

Cat. No.	Description	Prepared Injury Size	Box Qty.
252	BIAS UNI-SEAL	13mm, 1/2"	6
253	BIAS UNI-SEAL 14 ply rated	20mm, 3/4"	6
262	BIAS CUTTER	13mm, 1/2"	1

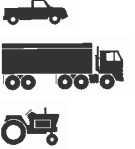

TECH Uni-Seal Ultra, Uni-Seal Ultra Max & Bias Uni-Seal Repair Limitations Chart

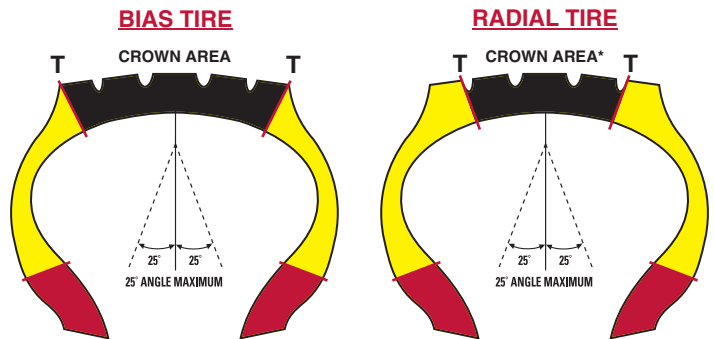

Angles greater than 25° require a 2 piece repair system to be used.
 *Radial tire crown area begins 1" (25mm) from tread edge on passenger tires, or 1 1/2" (40mm) on all truck and ag. tires.

RADIAL AND BIAS CROWN INJURIES

Prepared Crown Injury Size	H, V, Z Rated & Run Flat Tires (limit 1)	T Rated Tires & Below	Light Truck Tires	Medium & Heavy Truck Tires	Ag, Industrial & Small OTR Tires	<p>REPAIRS MUST NOT OVERLAP!</p> <p>REPAIRS MUST NOT BE IN THE SAME BODY PLY!</p>
3mm	UL3	UL3				
6mm	UL6	UL6	UL6	UL6		
8mm			UL8	UL8		
10mm			UL10	UL10	UL10	
13mm			UL13	UL13	UL13	

TECH Uni-Seal Ultra Stems for 2-Piece Repair

Tech Uni-Seal Ultra stems feature a lead wire for quick easy installation in prepared tire injuries. Each stem is wrapped with Tech's thick chemical cushion gum which permanently fills, seals, and vulcanizes to the tire. The photo (right) shows a 6mm (1/4") prepared injury and the same size injury filled with a ULS6 Uni-Seal Ultra Stem.

These stems must be used in conjunction with the appropriate repair unit on the inside of the tire. Refer to repair charts on page 7.

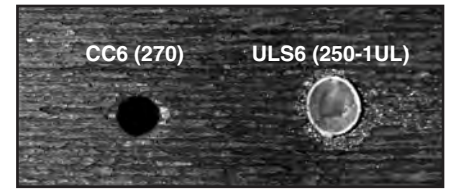

UNI-SEAL ULTRA STEMS FOR 2-PIECE REPAIR

Cat. No.	Description	Prepared Injury Size	Box Qty.
250-1UL	ULS6 UNI-SEAL ULTRA STEM	6mm, 1/4"	20
251-1UL	ULS8 UNI-SEAL ULTRA STEM	8mm, 5/16"	20
291-1UL	ULS10 UNI-SEAL ULTRA STEM	10mm, 3/8"	20
270	CC6 CARBIDE CUTTER	6mm, 1/4"	1
270P	CC6P CARBIDE CUTTER for passenger tires	6mm, 1/4"	1
271	CC8 CARBIDE CUTTER	8mm, 5/16"	1
271/38	CC10 CARBIDE CUTTER	10mm, 3/8"	1
S1040	QUICK CHANGE ADAPTOR for CC6, CC6P		1
S1041	QUICK CHANGE ADAPTOR for CC8		1
S1041/38	QUICK CHANGE ADAPTOR for CC10		1
911	2mm ALLEN WRENCH for small QC adaptors (not shown)		1
912	3mm ALLEN WRENCH for S1041/38 QC adaptor (not shown)		1

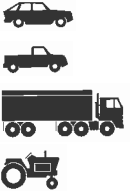

TECH Uni-Seal Stems for Large 2-Piece Repair

Uni-Seal stems are designed to fill large punctures in truck, agricultural, industrial, and small OTR tires. Once the damage has been removed with the appropriate cutter, the oversized stem fills the injury with a compression fit. The thick chemical cushion gum wrapped around each stem permanently seals and vulcanizes to the tire.

These stems must be used in conjunction with the appropriate repair unit on the inside of the tire. Refer to repair charts on pages 7, 10 and 13.

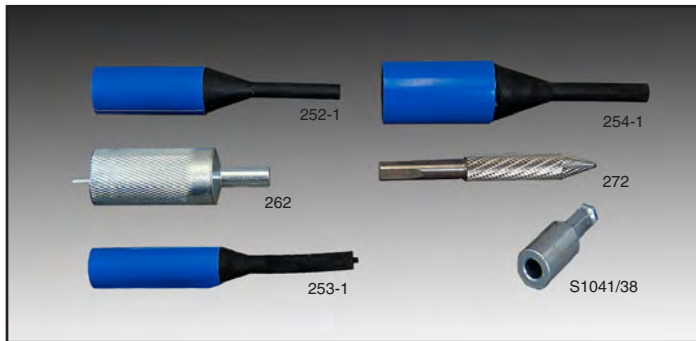

UNI-SEAL STEMS FOR LARGE 2-PIECE REPAIR

Cat. No.	Description	Prepared Injury Size	Box Qty.
252-1	UNI-SEAL STEM with Chemical Gum	13mm, 1/2"	10
253-1	UNI-SEAL STEM with Chemical Gum	20mm, 3/4"	10
254-1	UNI-SEAL STEM with Chemical Gum	25mm, 1"	10
272	CC13 CARBIDE CUTTER for 252-1	13mm, 1/2"	1
262	BIAS CUTTER for 252-1	13mm, 1/2"	1



TECH MP Repairs for 2-Piece Repair

Tech Multi-Purpose (MP) repairs are produced with unique cross-weave reinforcement and thick chemical cushion gum that provides excellent performance in both radial and bias tires. MP repairs must be used to repair crown area punctures in conjunction with the appropriate Uni-Seal Ultra Stem as a 2-Piece repair.



MULTI-PURPOSE REPAIR UNITS

Cat. No.	Description	Dim. (mm)	Dim. (inches)	Box Qty.
600	MP-0	60	2 1/4	25
600T	MP-0	60	2 1/4	80
601	MP-1	75	3	20
602	MP-2	90	3 1/2	10
112	MP-10	75	3	30

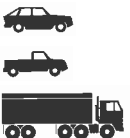

Refer to Recommended Application Chart on page 7.

TECH Centech Radial Nail Hole Repairs for 2-Piece Repair

Global tire industry recommendations and tire manufacturers' warranties state that nail hole repairs (puncture repairs) must include a rubber stem or suitable rubber vulcanizing material to fill the prepared injury and a repair unit to seal the inner liner and reinforce the tire on the inside.

Tech Centech Radial Repairs and MP repairs used in conjunction with Uni-Seal Ultra stems meet or exceed these requirements as a 2-Piece repair system. Tech's 2-Piece repair system provides a permanent, safe repair for crown and shoulder area injuries that last the life of the tire. For more information refer to Tech How-To-Repair Manual RM-5 or Nail Hole Repair Video RDVD1.



CENTECH NAIL HOLE REPAIR UNITS

Cat. No.	Description	Dim. (mm)	Dim. (inches)	Box Qty.
164	CT10-HD	65 x 80	2½ x 3¼	10
165	CT-10	45 x 75	1¾ x 3	20
165T	CT-10 in plastic tub	45 x 75	1¾ x 3	80
166	CT-12HD	70 x 115	2¾ x 4½	10
167	CT-12	60 x 110	2¾ x 4¾	10
167T	CT-12 in plastic tub	60 x 110	2¾ x 4¾	40
169	CT-14	75 x 145	2⅞ x 5¾	10
170	CT20	75 x 125	3 x 5	10



TECH Centech Radial Repairs for Shoulder Injuries



CENTECH SHOULDER REPAIR PLACEMENT

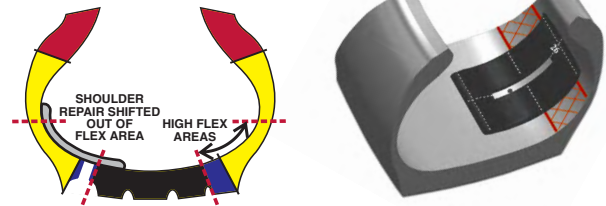

CENTECH RADIAL REPAIRS

Cat. No.	Description	Dim. (mm)	Dim. (inches)	Box Qty.
172	CT-22	75 x 165	3 x 6½	10
174	CT-24	86 x 222	3⅜ x 8¾	10
RSR-26	CT-26-RSR	75 x 250	3 x 10	10

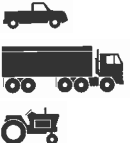

TECH Tire Repair Chemicals

For best results, Tech nail hole repairs should be used with these Tech chemical products.







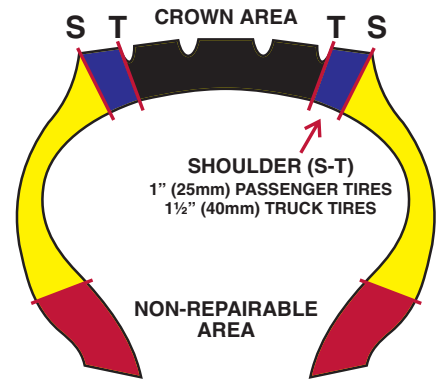

TECH CHEMICALS

Cat. No.	Description	Box Qty.
704	RUB-O-MATIC rubber cleaner, 32 oz., 945ml can	1
704A	RUB-O-MATIC rubber cleaner aerosol spray, 11.75 oz., 336g	1
705C	TECH CITRUS-BASED RUBBER CLEANER, 32 oz., 945ml can	1
735	BEAD SEALER, 32 oz., 945ml can with brush	1
738	SECURITY COAT inner liner repair sealer, water based, 16 oz., 470ml can with applicator	1
739	BUTYL LINER REPAIR SEALER, 32 oz., 945ml can with brush cap	1
751	TECH CHEK leak detector concentrate, 32 oz., 945ml	1
760	CHEMICAL VULCANIZING FLUID, 7.8 oz., 230ml can with brush	1

Radial 2-Piece Nail Hole Repair Limitations



MAXIMUM PREPARED INJURY – RADIAL

TYPE OF TIRE	Prepared Injury Size	Carbide Cutter	Uni-Seal Stem	Crown Area Repair Unit	Shoulder Area Repair Unit	REPAIRS MUST NOT OVERLAP! 
Passenger Tires <small>(H, V & Z Rated & Run Flat Tires) Limit 1 Per Tire</small> 	1/4" (6mm)	CC6 (270)	ULS6 (250-1UL)	CT-10, MP-0 OR 111		
Light Truck Tires 	1/4" (6mm)	CC6 (270)	ULS6 (250-1UL)	CT-10, MP-0 OR 111	CT-22	
	5/16" (8mm)	CC8 (271)	ULS8 (251-1UL)	CT-12, MP-0 OR 111	CT-22	
	3/8" (10mm)	CC10 (271/38)	ULS10 (291-1UL)	CT-20, MP-2 OR 112	CT-24	
Truck & Farm Tractor Tires  	1/4" (6mm)	CC6 (270)	ULS6 (250-1UL)	CT-10HD, MP-1 OR 111	CT-24	
	5/16" (8mm)	CC8 (271)	ULS8 (251-1UL)	CT-12HD, MP-2 OR 111	CT-24	
	3/8" (10mm)	CC10 (271/38)	ULS10 (291-1UL)	CT-20 OR 112	CT-26	
Heavy Truck & Super Singles	3/8" (10mm)	CC10 (271/38)	ULS10 (291-1UL)	CT-20 OR 112	CT-26	REPAIRS MUST NOT BE IN THE SAME BODY PLY! 

Bias 2-Piece Nail Hole Repair Limitations

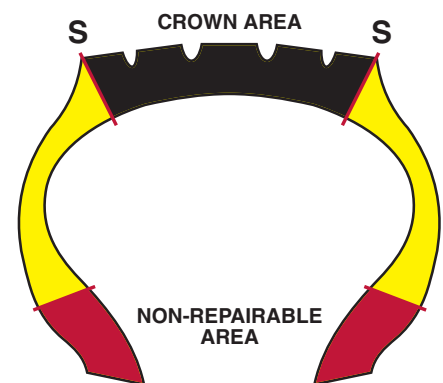

MAXIMUM PREPARED INJURY – BIAS

Prepared Injury Size	Carbide Cutter	Uni-Seal Stem	6 Ply	8 Ply	10-12 Ply	14-22 Ply	REPAIRS MUST NOT OVERLAP! 
1/4" (6mm)	CC6 (270)	ULS6 (250-1UL)	MP-0	MP-0	MP-0	MP-1	
5/16" (8mm)	CC8 (271)	ULS8 (251-1UL)	MP-0	MP-1	MP-1	MP-1	
3/8" (10mm)	CC10 (271/38)	ULS10 (291-1UL)	MP-1	MP-2	MP-2	112	

TECH Centech Radial Section Repair Units

Centech Radial Chemical Repairs, produced with soft gray cushion gum, are ideal for cold chemical vulcanization after the prepared injury has been filled with rubber and cured with heat. Centech repairs are center-over-injury designed and reinforced to restore the strength and flexibility to radial tires. For best results, use with 760 Chemical Vulcanizing Fluid or 775 Heavy Duty Blue Cement.

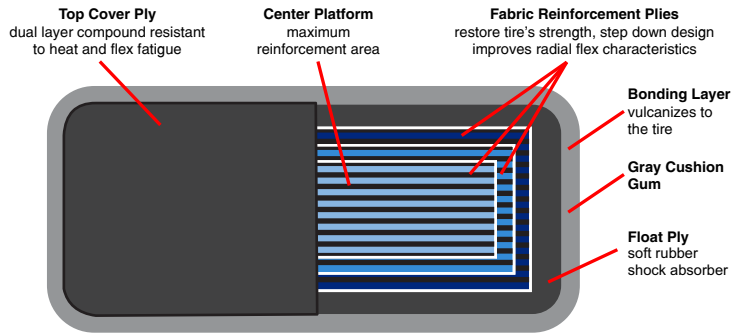

CENTECH CROWN REPAIR UNITS

Centech crown repairs reduce preparation and material costs by up to 40% over standard repairs.

Cat. No.	Description	Dim. (mm)	Dim. (inches)	Box Qty.
177	CT-33	100 x 125	4 x 5	10
178	CT-35	125 x 150	5 x 6	10
179	CT-37	125 x 170	5 x 6 $\frac{3}{4}$	5

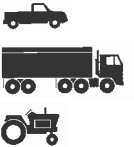

Refer to Repair Limitations Chart on page 10.

Centech Cloth Back style repairs provide maximum adhesion and shelf life. Add suffix "C" to Cat. No. (177C indicates CT-33 Cloth Back).

Aramid reinforcement provides added strength and flexibility to the repair unit to help reduce sidewall bulges. Add suffix "AC" to Cat. No. Not available with gray cushion gum.



CENTECH CENTER-OVER-INJURY REPAIR UNITS

Cat. No.	Description	Dim. (mm)	Dim. (inches)	Box Qty.
176	CT-26	75 x 250	3 x 10	10
180	CT-40	100 x 203	4 x 8	10
182	CT-42	125 x 250	5 x 10	5
184	CT-44	125 x 330	5 x 13	5
CT46A*	Aramid reinforced	156 x 416	6 $\frac{1}{8}$ x 16 $\frac{3}{8}$	5



Centech Cloth Back style repairs provide maximum adhesion and shelf life. Add suffix "C" to Cat. No.

*Aramid reinforcement provides added strength and flexibility to the repair unit to help reduce sidewall bulges.



CENTECH RADIAL AG REPAIRS

Cat. No.	Description	Dim. (mm)	Dim. (inches)	Box Qty.
196	CT-80	150 x 195	6 x 7 $\frac{3}{4}$	5
197	CT-82	190 x 250	7 $\frac{1}{2}$ x 10	5
198	CT-84	215 x 290	8 $\frac{1}{2}$ x 11 $\frac{1}{2}$	5
199	CT-86	254 x 350	10 x 13 $\frac{3}{4}$	5



Add suffix "R" to Cat. No. to order Thermacure Radial Tractor Repairs. Add suffix "C" to Cat. No. to order Cloth Back repairs.

TECH Thermacure Radial Repair Units

Tech Thermacure radial repairs, produced with soft black cushion gum, provide excellent adhesion in all heat cure systems. Thermacure has been designed and tested to perform in the tire through multiple retread applications. Thermacure repairs are center-over-injury designed and reinforced to restore the strength and flexibility to all radial tires. For best results, use with Tech Tem-Vulc Black Cement in heat cure applications. Use with 760 Chemical Vulcanizing Fluid or 775 Heavy Duty Blue Cement in cold chemical cure applications.

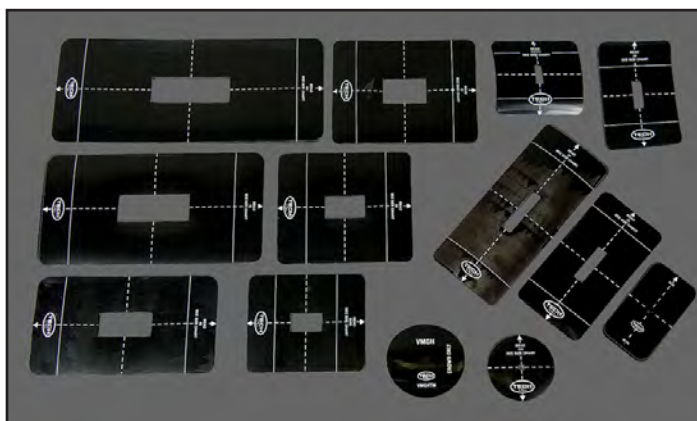
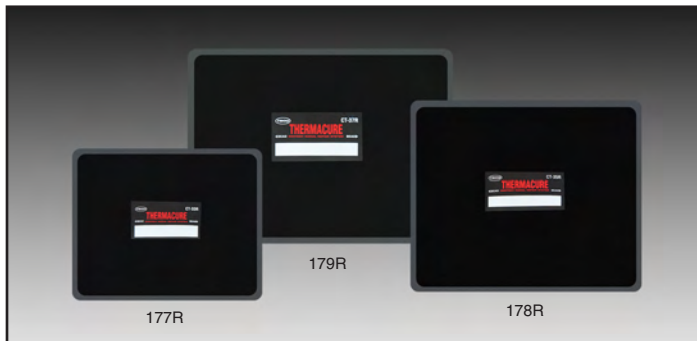
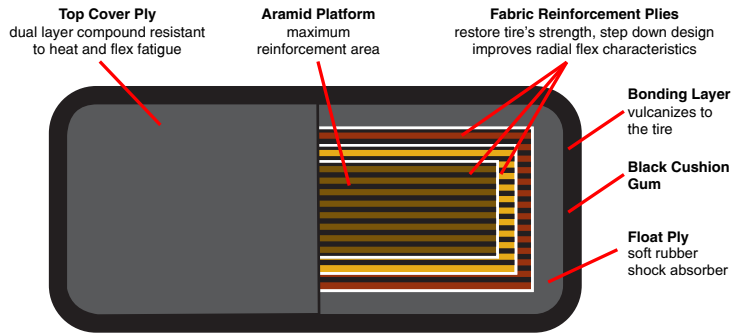

THERMACURE NAIL HOLE REPAIRS

Cat. No.	Description	Dim. (mm)	Dim. (inches)	Box Qty.
111R	Round All Purpose	65	2½	50
112R	MP-10R	75	3	30
164R	CT-10HDR	65 x 80	2½ x 3¼	10
166R	CT-12HDR	70 x 115	2¾ x 4⅝	10
169R	CT-14R	75 x 145	2⅞ x 5¾	10
170R	CT-20R	75 x 125	3 x 5	10

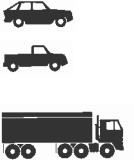

Refer to Repair Limitations Chart on page 10.

THERMACURE CROWN REPAIRS

Crown repairs reduce preparation and material costs by up to 40% over standard repairs.

Cat. No.	Description	Dim. (mm)	Dim. (inches)	Box Qty.
177R	CT-33R	100 x 125	4 x 5	10
178R	CT-35R	125 x 150	5 x 6	10
179R	CT-37R	125 x 170	5 x 6¾	5



Refer to Repair Limitations Chart on page 10.

Aramid reinforcement provides added strength and flexibility to the repair unit to help reduce sidewall bulges. Add suffix "AR" to Cat. No.

THERMACURE CENTER-OVER-INJURY REPAIRS

Cat. No.	Description	Dim. (mm)	Dim. (inches)	Box Qty.
172R	CT-22R	75 x 165	3 x 6½	10
174R	CT-24R	86 x 222	3⅜ x 8¾	10
180R	CT-40R	100 x 200	4 x 8	10
182R	CT-42R	125 x 250	5 x 10	5
184R	CT-44R	125 x 330	5 x 13	5
CT46AR	Aramid reinforced	156 x 416	6⅛ x 16⅜	5



Refer to Repair Limitations Chart on page 10.

Aramid reinforcement provides added strength and flexibility to the repair unit to help reduce sidewall bulges. Add suffix "AR" to Cat. No. Aramid reinforcement not available on 172R or 174R.

TECH REPAIR TEMPLATES

Used with marking crayons, paint sticks or silver ink pens, templates properly outline area to be buffed. Available for Uni-Seals, Centech repairs through Cat. No. 184, CT-44, Thermacure repairs and 111 All Purpose round repair.

Cat. No.	Description	Packaged
111TM	TEMPLATE for 111 All Purpose Repair, 250UL, 251UL	Ea.
165TM	TEMPLATE for CT-10 Centech repair	Ea.
167TM	TEMPLATE for CT-12 Centech repair	Ea.
170TM	TEMPLATE for CT-20 Centech repair	Ea.
172TM	TEMPLATE for CT-22 Centech repair	Ea.
174TM	TEMPLATE for CT-24 Centech repair	Ea.
176TM	TEMPLATE for CT-26 Centech repair	Ea.
177TM	TEMPLATE for CT-33 Centech repair	Ea.
178TM	TEMPLATE for CT-35 Centech repair	Ea.
179TM	TEMPLATE for CT-37 Centech repair	Ea.
180TM	TEMPLATE for CT-40 Centech repair	Ea.
182TM	TEMPLATE for CT-42 Centech repair	Ea.
184TM	TEMPLATE for CT-44 Centech repair	Ea.
RTMS	REPAIR TEMPLATE SET	Ea.
S3/M10/291TM	TEMPLATE for 3" square repairs	Ea.

Centech & Thermacure Radial Repair Chart

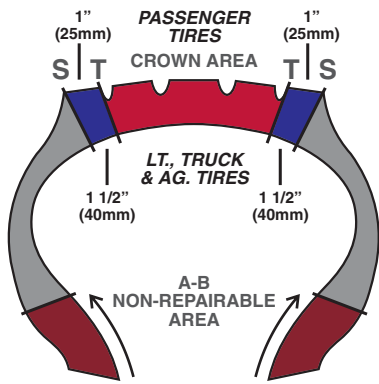

A-B NON-REPAIRABLE AREA	
Passenger Tires	1 1/2" (40mm)
TRUCK TIRE A-B NON REPAIRABLE AREA	
6.50-7.00 (165-195)	2 1/2" (65mm)
7.50-16.00 (205-385)	3" (75mm)
17.5-23.5 (425-600)	3 1/2" (90mm)
AG TIRE A-B NON REPAIRABLE AREA	
13.6-16.9 (345-430)	4" (100mm)
18.4-20.8 (465-530)	4 1/2" (115mm)
23.1 & Larger (585 & larger)	5 1/2" (140mm)

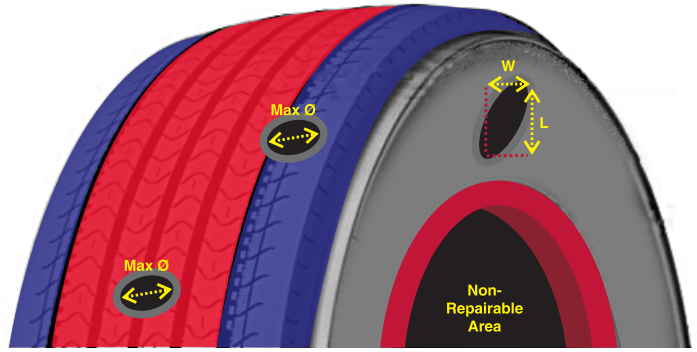

Centech Radial Truck Tire Repair Chart

CROWN AREA BEGINS 1 1/2" (40mm) IN FROM TREAD EDGE

Sidewall Injury	Shoulder Injury Diameter (S-T Area)	Truck Tire Sizes			Crown Injury Diameter (T-T Area)
		Light Truck Load Range E	Heavy Truck	Heavy Truck	
		6.50-12.50	7.50-10.00	11.00-14.00	
		LT 215-285	8-11 235/80-275/80 225/75-295/75	12-16.5 295/80-315/80 305/75-445/65 425/50-495/45	
Width	Length				
1/4" (6mm)	1/4" (6mm)	10	20	20	1/4" (6mm)
		22	24	26	
5/16" (8mm)	5/16" (8mm)	12	20	20	5/16" (8mm)
		22	24	26	
1 Cable	1 1/2" (40mm)	20	20	20	
1 Cable	3 1/8" (80mm)	22	24	24	
1 Cable	4 3/4" (120mm)	22	24	24	
1 Cable	6" (150mm)	26	26	26	
2 Cables	3/4" (20mm)	20	20	24	
2 Cables	1 1/2" (40mm)	20	24	24	
2 Cables	2 3/8" (60mm)	22	24	26	
2 Cables	5 1/8" (130mm)	26	26	26	
3/8" (10mm)	1 1/2" (40mm)	20	26	40	
3/8" (10mm)	2 3/8" (60mm)	22	26	40	
3/8" (10mm)	3 1/8" (80mm)	26	40	42	
3/8" (10mm)	5 1/8" (130mm)	42	42	44	
	3/8" (10mm)	24	26	26	
		33	33	33	
1/2" (13mm)	1 1/2" (40mm)	22	40	40	1/2" (13mm)
1/2" (13mm)	2 3/4" (70mm)	22	40	42	
1/2" (13mm)	3 3/4" (95mm)	40	42	42	
1/2" (13mm)	5 1/8" (130mm)	44	44	44	
	1/2" (13mm)	40	40	40	
		33	35	35	
3/4" (20mm)	1" (25mm)	22	40	40	3/4" (20mm)
3/4" (20mm)	2 1/2" (65mm)	24	42	42	
3/4" (20mm)	4 3/8" (110mm)	42	44	44	
3/4" (20mm)	5 1/8" (130mm)	44	44	44	
	3/4" (20mm)	40	42	42	
		33	35	37	
1" (25mm)	2" (50mm)	40	42	44	1" (25mm)
1" (25mm)	3 1/4" (80mm)	42	44	44	
1" (25mm)	4" (100mm)	44	44	44	
	1" (25mm)	44	44	44	
		35	37	37	
1 1/4" (32mm)	2" (50mm)	42	44	44	1 1/4" (32mm)
1 1/4" (32mm)	3 1/8" (80mm)	44	44	44	
1 1/4" (32mm)	4" (100mm)	44	44	46	

REPAIR UNITS SHOWN [BOXED IN RED] ARE LIMITED TO CROWN (T-T) AREA ONLY. ALL OTHERS SHOWN IN RED MAY BE USED FOR CROWN OR SIDEWALL INJURIES. NOTE: THIS SECTION REPAIR CHART IS A GUIDELINE ONLY. LOAD, SPEED AND HIGHWAY APPLICATION CAN AFFECT THE LIMITATIONS OF SECTION REPAIRS.

REPAIR UNIT DIMENSIONS		
Repair Unit	Inches	Millimeters
CT10	1.75 X 3	45 X 75
CT10HD	2.5 X 3.25	65 X 80
CT12	2.38 X 4.38	60 X 110
CT12HD	2.75 X 4.6	70 X 115
CT20	3 X 5	75 X 125
CT22	3 X 6.5	75 X 165
CT24	3 X 8.5	75 X 215
CT26	3 X 10	75 X 250
CT33	4 X 5	100 X 125
CT35	5 X 6	125 X 150
CT37	5 X 6.75	125 X 170
CT40	4 X 8	100 X 200
CT42	5 X 10	125 X 250
CT44	5 X 13	125 X 330
CT46	5.5 X 16	140 X 405

Centech Radial Passenger Repair Chart

Note: This section repair chart is a guideline only. Local regulations, load and speed can affect the limitations of section repairs. Injuries beyond the crown area and/or larger than 6mm (1/4") after preparation in passenger and some light truck tires should only be repaired in a full service repair facility.

CROWN AREA BEGINS 1" (25mm) IN FROM TREAD EDGE

Sidewall Injury	Through U Speed Rating	Speed Rated H, V, W, Y & Z, and Run Flat Tires	Crown Injury Diameter
	10	10	1/4" (6mm)
1/4" (6mm)	1/2" (13mm)		
1/4" (6mm)	2" (50mm)		
3/8" (10mm)	3/8" (10mm)	10HD	
3/8" (10mm)	1 1/2" (40mm)	12HD	3/8" (10mm)
3/8" (10mm)	2" (50mm)	14	
1/2" (13mm)	1 1/2" (40mm)	12HD	1/2" (13mm)
1/2" (13mm)	2" (50mm)	14	
3/4" (20mm)	3/4" (20mm)	12HD	
3/4" (20mm)	1 1/2" (40mm)	12HD	3/4" (20mm)
3/4" (20mm)	2" (50mm)	14	
1" (25mm)	1 1/2" (40mm)	14	1" (25mm)
1" (25mm)	2" (50mm)	14	

REPAIR UNITS SHOWN IN RED MAY BE USED FOR CROWN OR SIDEWALL INJURIES. TO MAINTAIN THEIR SPEED RATING, PASSENGER TIRES CARRYING A SPEED RATING OF H, V, W, Y OR Z SHOULD ONLY BE REPAIRED IN THE CROWN (T-T) AREA WITH A MAXIMUM SIZE OF 1/4" (6mm).

Centech Radial AG Tire Repair Chart

CROWN AREA BEGINS 1 1/2" (40mm) IN FROM TREAD EDGE

Sidewall Injury	Shoulder Injury	Tractor Sizes			Crown Injury Diameter
		8-11 8.3-12.4	12-15 13.6-23.5 440/65-600/65	24.5-30.5 620/75-1050/50	
1/4" (6mm)	1/4" (6mm)	12	12	20	3/8" (10mm)
3/8" (10mm)	3/8" (10mm)	12	12	20	
3/8" (10mm)	1 1/2" (40mm)	20	20	22	
3/8" (10mm)	5" (125mm)	26	26	26	
	3/8" (10mm)	20	20	22	
3/4" (20mm)	3/4" (20mm)	20	20	22	3/4" (20mm)
3/4" (20mm)	3" (75mm)	22	80	80	
	3/4" (20mm)	22	80	80	
1 1/2" (40mm)	4" (100mm)	80	82	82	1 1/2" (40mm)
	1 1/2" (40mm)	80	82	82	
2" (50mm)	3 1/4" (80mm)	80	82	84	
	2" (50mm)	82	84	84	
2 1/2" (65mm)	3" (75mm)	80	82	84	2 3/4" (70mm)
2 1/2" (65mm)	4" (100mm)	80	82	84	
2 3/4" (70mm)	2 3/4" (70mm)	80	82	84	
	2 3/4" (70mm)	86	86	86	
3 1/4" (80mm)	3 1/4" (80mm)	82	84	84	3 1/2" (90mm)
3 1/4" (80mm)	5 1/4" (130mm)	84	86	86	
3 1/2" (90mm)	4 1/2" (115mm)	84	86	86	
4" (100mm)	4" (100mm)	84	86	86	4" (100mm)
4" (100mm)	6 1/2" (165mm)	86	86	86	
5" (125mm)	5" (125mm)	86	86	86	5" (125mm)

NOTE: THIS SECTION REPAIR CHART IS A GUIDELINE ONLY. REPAIR UNITS SHOWN IN RED MAY BE USED FOR CROWN OR SIDEWALL INJURIES. LOAD, SPEED AND HIGHWAY APPLICATION CAN AFFECT THE LIMITATIONS OF SECTION REPAIRS.

BP Bias Ply Tire Repairs

Tech BP repair units, produced with soft gray cushion gum, provide excellent adhesion when used with Tech 760 Chemical Vulcanizing Fluid or 775 Heavy Duty Blue Cement. These repairs are designed to restore the strength and flexibility to bias passenger, truck, farm tractor, skidder and small OTR tires.

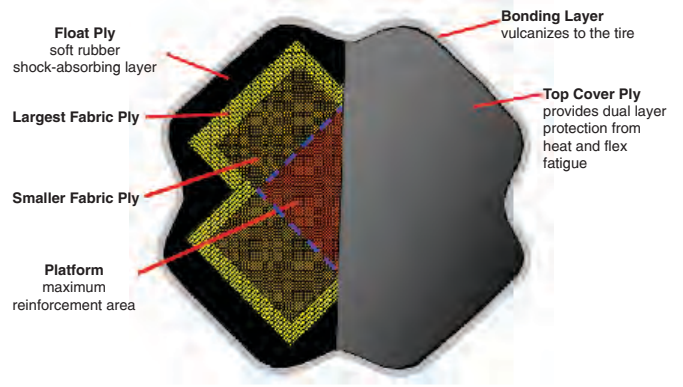

BP REPAIRS

Cat. No.	Description	Dim. (mm)	Dim. (inches)	Plies	Box Qty.
603	BP-3	100	4	2	10
604	BP-4	130	5 ⁵ / ₁₆	4	10
605	BP-5	165	6 ¹ / ₂	4	10

Add suffix "C" to Cat. No. to order Cloth Back repairs. Refer to Repair Limitations Chart on page 13.



BP REPAIRS

Cat. No.	Description	Dim. (mm)	Dim. (inches)	Plies	Box Qty.
606	BP-6	240	9 ⁹ / ₁₆	6	5
607	BP-7	290	11 ⁵ / ₈	6	5
608	BP-8	340	13 ⁵ / ₈	6	5
609	BP-9	380	15 ¹ / ₈	8	3
610	BP-10	430	17 ¹ / ₈	8	3

Add suffix "C" to Cat. No. to order Cloth Back repairs. Refer to Repair Limitations Chart on page 13.

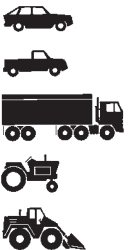

TECH BPT Bias Ply Tractor Repairs

Tech BPT bias ply repairs are designed with a wide ply reinforcement package that provides strength and flexibility over large injuries in bias agricultural and forestry tires.



BPT BIAS PLY TRACTOR REPAIRS

Cat. No.	Description	Dim. (mm)	Dim. (inches)	Plies	Box Qty.
620	BPT-0	200	8	4	10
621	BPT-1	225	9	4	5
622	BPT-2	275	11	4	5
623	BPT-3	375	15	4	5
624	BPT-4	225	9	6	5
625	BPT-5	275	11	6	5
626	BPT-6	375	15	6	5
627	BPT-7	490	19 ¹ / ₂	6	3

Add suffix "C" to Cat. No. to order Cloth Back repairs. Refer to Repair Limitations Chart on page 13.



BP THERMACURE Bias Ply Tire Repairs

BP Thermacure repairs are designed for bias truck, agricultural and light duty OTR tire applications up to 22 Ply rated. Thermacure soft black cushion gum provides excellent adhesion in cold chemical cure applications when used with 775 Tech Heavy Duty Blue Cement or with 1082 Tech Tem-Vulc Black Cement in heat cure applications.

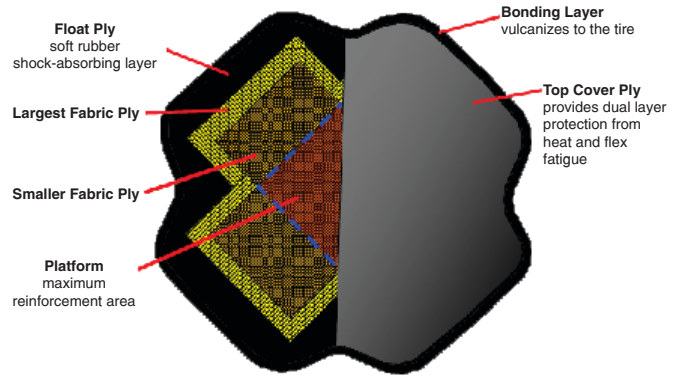

THERMACURE BP REPAIRS

Cat. No.	Description	Dim. (mm)	Dim. (inches)	Plies	Box Qty.
603R	BP-3R	100	4	2	10
604R	BP-4R	130	5 ⁵ / ₁₆	4	10
605R	BP-5R	165	6 ¹ / ₂	4	10
606R	BP-6R	240	9 ⁹ / ₁₆	6	5
607R	BP-7R	290	11 ⁵ / ₈	6	5
608R	BP-8R	340	13 ⁵ / ₈	6	5
609R	BP-9R	380	15 ¹ / ₈	8	3
610R	BP-10R	430	17 ¹ / ₈	8	3

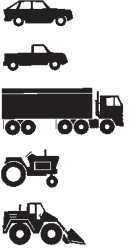

Refer to Repair Limitations Chart on page 13.

TECH Bias Skidder Repairs

Tech Bias Skidder (SK) Repairs are specially designed for forestry application tires. SK repairs utilize a wide platform reinforcement package with OTR tire cord for maximum strength. Tech produces these repairs with Thermacure soft cushion gum for hot or cold vulcanization. For best results use with 775 Heavy Duty Blue Cement or 1082 Tem-Vulc black cement in heat cure applications.



BIAS SKIDDER REPAIRS

Cat. No.	Description	Dim. (mm)	Dim. (inches)	Plies	Box Qty.
SK12R	Bias Skidder Repair	300	12	6	12
SK16R	Bias Skidder Repair	400	16	6	6
SK20R	Bias Skidder Repair	500	20	6	6
SK24R	Bias Skidder Repair	600	24	8	3



TECH Bias Skidder Tire Repair Chart

PREPARED INJURY SIZE

PLY RATING (LOAD RANGE)	PREPARED INJURY SIZE									
	Inches mm	4" 100	5" 125	6" 150	7" 175	8" 200	9" 225	10" 250	11" 275	12" 300
10-12		12	12	12	16	16	20	20	24	24
14-16		12	12	16	20	20	20	24	24	24
18-20		12	16	20	20	20	24	24	24	24
22-24		16	20	20	24	24	24	TOR9*	TOR9*	
26-28		TOR5	TOR6	TOR7	TOR7	TOR8	TOR8	TOR9	TOR9*	TOR10*

FOR 6 TO 8 PLY RATED TIRES AND INJURIES SMALLER THAN SHOWN ON THIS CHART, REFER TO BPT CHART ON PAGE 13. *CROWN AREA INJURIES ONLY.

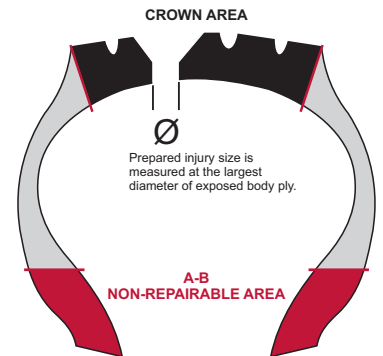

SKIDDER A-B NON-REPAIRABLE AREA

Section Width	Dimension
14.9-20.8	4", 100mm
23.1 & larger	5", 125mm



Bias Repair Chart



A-B NON-REPAIRABLE AREA

7.00-8.75	3 1/4", 80mm
9.00-14.00	4", 100mm
16.00-18.00	5", 125mm
21.00-27.00	6", 150mm

The above dimensions are guidelines only.

TRACTOR A-B NON-REPAIRABLE AREA

Section Width	A-B Dimension
14.9-20.8 (215-520)	4", 100mm
23.1 & Larger (600 & Larger)	5", 125mm

The above dimensions are guidelines only.

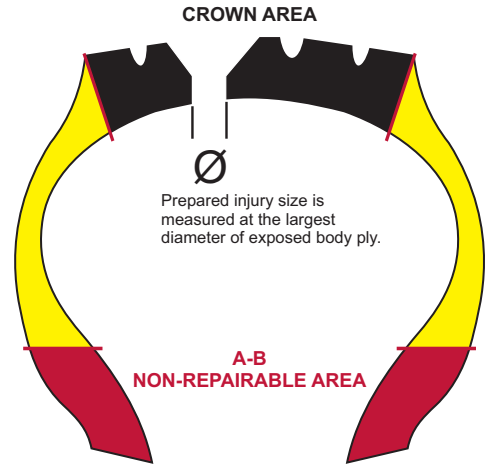

CHART INSTRUCTIONS: For proper repair unit selection, determine the size of the injury in the tire by measuring largest cord area removed. Locate the correct injury size along the top row of the chart. Now locate the tire's ply rating (load range) along the left column of the same chart. The repair unit number shown in the box where these intersect is the correct repair unit to use.

NOTE: THIS SECTION REPAIR CHART IS ONLY A GUIDELINE. LOAD, SPEED AND APPLICATION OF THE TIRE CAN AFFECT THE LIMITATIONS OF SECTION REPAIRS.

CAR, TRUCK AND EARTHMOVER
SIZE OF INJURY – TREAD, SHOULDER AND SIDEWALL



PLY RATING (LOAD RANGE)	mm	3	6	10	13	20	25	40	50	65	75	100	125	150
	inches	3/8"	1/4"	3/8"	1/2"	3/4"	1"	1 1/2"	2"	2 1/2"	3"	4"	5"	6"
4 (B)		MP-0	MP-0	MP-1	MP-2	BP-3	BP-3	BP-4	BP-5					
6 (C)		MP-0	MP-0	MP-1	MP-2	BP-3	BP-3	BP-4	BP-5	BP-6				
8 (D)		MP-0	MP-0	MP-2	BP-3	BP-3	BP-4	BP-4	BP-5	BP-6				
10 (E)		MP-0	MP-1	MP-2	BP-3	BP-3	BP-4	BP-5	BP-6	BP-6	BP-7	BP-8		
12 (F)		MP-0	MP-1	MP-2	BP-4	BP-4	BP-4	BP-5	BP-6	BP-6	BP-7	BP-8		
14 (G)		MP-0	MP-1	BP-3	BP-4	BP-4	BP-5	BP-6	BP-6	BP-7	BP-7	BP-8	BP-10	
16 (H)		MP-0	MP-1	BP-4	BP-4	BP-5	BP-5	BP-6	BP-6	BP-7	BP-7	BP-8	BP-10	
18 (J)		MP-0	MP-1	BP-4	BP-5	BP-5	BP-6	BP-6	BP-7	BP-8	BP-8	BP-9	BP-10	
20 (L)		MP-0	MP-1	BP-4	BP-5	BP-5	BP-6	BP-7	BP-8	BP-8	BP-9	BP-9	BP-10	
22 (M)		MP-0	MP-1	BP-4	BP-6	BP-6	BP-7	BP-8	BP-8	BP-8	BP-9	BP-10		

FARM, TRACTOR, SKIDDER
SIZE OF INJURY – TREAD, SHOULDER AND SIDEWALL



PLY RATING (LOAD RANGE)	mm	3	6	10	13	20	25	40	50	65	75	100	125	150	175	200	225	250
	inches	3/8"	1/4"	3/8"	1/2"	3/4"	1"	1 1/2"	2"	2 1/2"	3"	4"	5"	6"	7"	8"	9"	10"
4 (B)		MP-0	MP-0	MP-1	MP-2	BP-3	BP-3	BP-4	BP-5	BPT-0	BPT-0	BPT-1	BPT-2	BPT-2	BPT-3	BPT-3		
6 (C)		MP-0	MP-0	MP-1	MP-2	BP-3	BP-3	BP-4	BP-5	BPT-0	BPT-0	BPT-1	BPT-2	BPT-2	BPT-3	BPT-3		
8 (D)		MP-0	MP-1	MP-2	MP-2	BP-3	BP-4	BP-4	BP-5	BPT-0	BPT-0	BPT-1	BPT-2	BPT-2	BPT-3	BPT-3	BPT-6	BPT-7
10 (E)		MP-0	MP-1	MP-2	BP-3	BP-3	BP-4	BP-5	BP-6	BPT-1	BPT-1	BPT-4	BPT-5	BPT-5	BPT-6	BPT-6	BPT-7	BPT-7
12 (F)		MP-0	MP-1	MP-2	BP-4	BP-4	BP-4	BP-5	BP-6	BPT-4	BPT-4	BPT-4	BPT-5	BPT-5	BPT-6	BPT-7	BPT-7	BPT-7
14 (G)		MP-0	MP-1	BP-4	BP-4	BP-4	BP-5	BP-6	BP-6	BPT-4	BPT-5	BPT-5	BPT-5	BPT-6	BPT-7	BPT-7	BPT-7	*
16 (H)		MP-0	MP-1	BP-4	BP-4	BP-5	BP-5	BP-6	BP-6	BPT-5	BPT-5	BPT-5	BPT-6	BPT-6	BPT-7	BPT-7	*	*
18 (J)		MP-1	MP-2	BP-4	BP-5	BP-5	BP-6	BP-6	BP-7	BPT-5	BPT-5	BPT-6	BPT-6	BPT-7	*	*	*	*

* FOR INJURIES LARGER THAN INDICATED ON THIS CHART OR FOR TIRES WITH PLY RATINGS HIGHER THAN 18, REFER TO THE BIAS SKIDDER REPAIR CHART.

***REINFORCEMENT REPAIRS**
SIZE OF INJURY – TREAD, SHOULDER AND SIDEWALL



PLY RATING (LOAD RANGE)	mm	6	10	13	20	25	40	50	65	75	100	125	150
	inches	1/4"	3/8"	1/2"	3/4"	1"	1 1/2"	2"	2 1/2"	3"	4"	5"	6"
8-12 (D-F)		MP-0	MP-1	MP-2	BP-3	BP-3	BP-4	BP-4	BP-5	BP-6	BP-7	BP-8	
14-18 (G-J)		MP-0	MP-1	MP-2	BP-4	BP-4	BP-5	BP-5	BP-6	BP-6	BP-7	BP-8	
20-22 (L-N)		MP-0	MP-2	BP-4	BP-5	BP-5	BP-6	BP-6	BP-7	BP-7	BP-8	BP-9	

* INJURIES THROUGH 25%, BUT LESS THAN 75% OF THE BODY PLYS REQUIRE BOTH HOLE FILLING MATERIAL AND REINFORCED REPAIR UNIT TO BE INSTALLED INSIDE THE TIRE.

CENTECH Aramid Reinforced Radial OTR Repairs

Centech Radial OTR repairs are reinforced with Aramid cord for maximum strength. Advanced rubber compounds provide longer performance life in the most extreme OTR tire service conditions. Centech Radial OTR repairs are very flexible, resulting in easy installation, minimizing the chances of trapped air as well as restoring the strength of the tire with little resistance to the tire's flex characteristics.

Tech is pleased to offer the most complete line of radial OTR repairs in the industry. Tech OTR repairs are available to work in all types of curing systems and perform in any tire service application.

CENTECH CHEMICAL OTR REPAIRS WITH ARAMID REINFORCEMENT



Centech Chemical repairs with Aramid reinforcement are recommended when the tires are cured with spotters or press systems. The repair unit is installed with Tech Chemical Vulcanizing Fluid or Heavy Duty Blue Cement after the filler rubber has been cured.

CENTECH THERMACURE OTR REPAIRS WITH ARAMID REINFORCEMENT



Centech Thermacure repairs with Aramid reinforcement are recommended when the tires are cured with spotters, press systems, section molds or Monaflex systems. Thermacure repair units should be installed with Tech Heavy Duty Blue Cement after the filler rubber has been cured. In heat cure applications the repair unit may also be installed using Tech TemVulc Black Cement.

CENTECH CLOTH BACKED OTR REPAIRS WITH ARAMID REINFORCEMENT



Centech Cloth Backed repairs with Aramid reinforcement are recommended for all heat cure vulcanizing systems. These repair units are produced on a special cloth backing material which provides optimum bonding surface texture. For best results, use with Tech TemVulc Black Cement and Vul-Gum cushion gum. Cloth backed repairs have a 5 year shelf life.

CENTECH HEAT CURE OTR REPAIRS WITH ARAMID REINFORCEMENT



Centech Heat Cure repairs with Aramid reinforcement are recommended for all heat cure vulcanizing systems and for section repairs requiring cure times longer than 5 hours. For best results, use with Tech TemVulc Black Cement.

CENTECH Aramid Reinforced Radial OTR Repairs

CENTECH CENTER OVER INJURY OTR REPAIRS

Chemical Repair Cat. No.	Thermacure Repair Cat. No.	Heat Cure Repair Cat. No.	Cloth Back Repair Cat. No.	Dimension inches	Dimension mm	Box Quantity
CT46A	CT46AR	CT46AH	CT46AC	6 1/8 x 16 3/8	156 x 416	5
CT50A	CT50AR	CT50AH	CT50AC	8 x 19 1/8	200 x 486	3
CT52A	CT52AR	CT52AH	CT52AC	10 x 22 1/2	250 X 570	3
CT56A	CT56AR	CT56AH	CT56AC	10 1/2 X 29 1/2	265 X 748	3
CT60A	CT60AR	CT60AH	CT60AC	10 1/2 X 34	265 X 860	3
CT62A	CT62AR	CT62AH	CT62AC	12 1/2 X 40 1/2	325 X 1030	1
CT72A	CT72AR	CT72AH	CT72AC	13 3/4 X 30	345 X 760	1

CENTECH CROWN ONLY REPAIRS WITH ARAMID REINFORCEMENT

Centech Crown Only repair units reduce repair costs by up to 40%. These repairs can be used on crown area injuries instead of much larger traditional center over injury repairs, resulting in lower material cost and less preparation time. These repairs have been redesigned to provide a wider range of placement in the crown area of the tire. Centech crown repair units are produced with chemical, Thermacure, and heat cure gums as well as cloth backed and uncured.

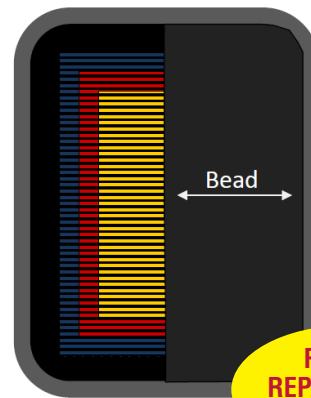

REDUCE REPAIR COSTS BY UP TO 40%

CENTECH CROWN ONLY OTR REPAIRS

Chemical Repair Cat. No.	Thermacure Repair Cat. No.	Heat Cure Repair Cat. No.	Cloth Back Repair Cat. No.	Uncured Repair No.	Dimension Inches	Dimension mm	Box Quantity
CT45A	CT45AR	CT45AH	CT45AC	CT45AU	9 1/8 x 7 3/4	230 x 195	5
CT55A	CT55AR	CT55AH	CT55AC	CT55AU	13 x 10 1/4	330 x 260	3
CT65A	CT65AR	CT65AH	CT65AC	CT65AU	16 1/2 x 13	420 x 330	3
CT75A	CT75AR	CT75AH	CT75AC	CT75AU	20 3/4 x 17 3/4	535 x 450	1
CT85A	CT85AR	CT85AH	CT85AC	CT85AU	28 x 22	710 x 560	1

TECH AX Severe Service Radial Repairs

AX radial repairs are a proven design, enhanced with a large aramid reinforced platform and advanced rubber compounds to perform in the most extreme service conditions. The AX non-flex to non-flex design is recommended for shoulder and sidewall injuries in tires used in severe service applications*.

AX Severe Service repairs are available in Uncured or Cloth Back for tires up to 63" rim diameter. These repairs are recommended for all heat cure vulcanizing systems. For best results, use with Tech Tem-Vulc Black Cement.

*For more information refer to Tech's OTR Repair Manual, RMOTR.

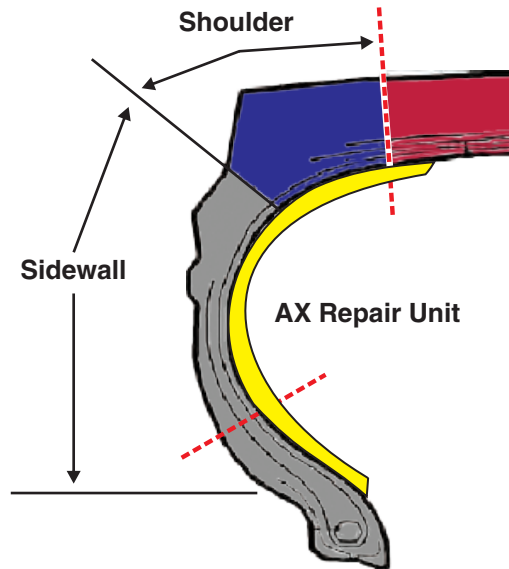
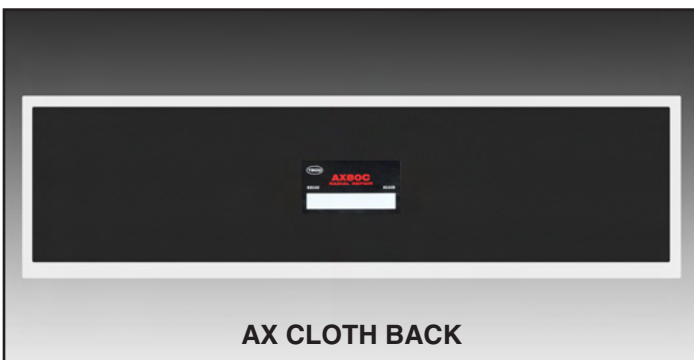

AX SEVERE SERVICE RADIAL OTR REPAIRS

Uncured Repair Cat. No.	Cloth Back Repair Cat. No.	Dimension Inches	Dimension mm	Box Quantity
AX50U	AX50C	8 x 19 1/8	200 x 486	6
AX60U	AX60C	8 1/2 X 24	215 X 610	6
AX80U	AX80C	9 1/2 X 28	240 X 710	3
AX100U	AX100C	11 X 31	280 X 790	3
AX120U	AX120C	11 X 35	280 X 890	3
AX140U	AX140C	14 1/2 X 46	370 X 1170	1
AX155U	AX155C	10 X 55	250 X 1400	1

TECH Radial OTR Repair Chart

Centech Aramid Reinforced Repairs

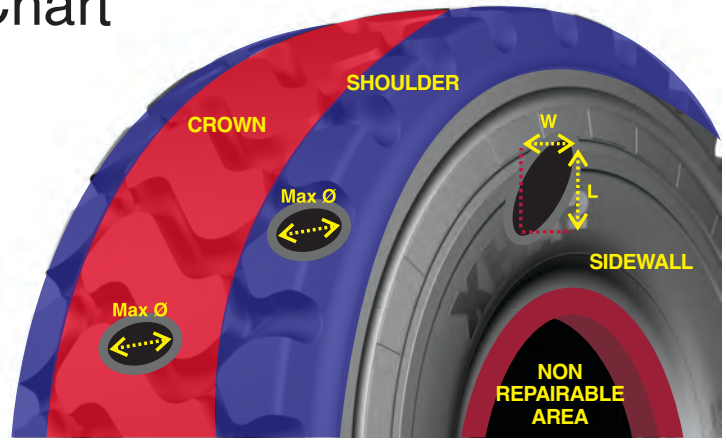

TIRE REPAIR PRODUCTS & REPAIR CHARTS



Sidewall Injury		Shoulder Injury	Earthmover Tire Sizes				Crown Injury
Width	Length	Diameter Ø	Inner liner removed on these sizes				Diameter Ø
Inches (mm)	Inches (mm)	Inches (mm)	14.00-16.00 15.5-20.5 20/65-30/65	18.00-21.00 23.5-26.5 35/65	24.00-30.00 29.5-37.5 40/65-45/65	33.00-40.00 48/95-59/80 50/65-65/65	Inches (mm)
3/8" (10mm)	3" (75mm)		42	42	42	44	3/8" (10mm)
3/8" (10mm)	4 3/8" (110mm)		42	42	44	44	3/4" (20mm)
3/4" (20mm)	2" (50mm)		45	45	45	45	
3/4" (20mm)	5 1/2" (140mm)		42	44	44	50	
3/4" (20mm)	8" (200mm)		46	46	46	50	1" (25mm)
		3/4" (20mm)	46	50	50	50	
			46	46	50	52	
1" (25mm)	5" (125mm)		45	45	45	45	1 1/2" (40mm)
1" (25mm)	8" (200mm)		46	46	46	50	
		1" (25mm)	50	50	50	52	
1 1/4" (30mm)	4" (100mm)		46	50	50	50	1 1/2" (40mm)
1 1/4" (30mm)	10" (250mm)		50	50	52	56	
			45	45	55	55	
1 1/2" (40mm)	3 1/2" (90mm)		46	50	52	52	1 1/2" (40mm)
1 1/2" (40mm)	10" (250mm)		50	50	52	56	
1 1/2" (40mm)	14" (350mm)		56	56	56	60	
1 1/2" (40mm)	16" (400mm)			60	60	60	2" (50mm)
1 3/4" (45mm)	6 1/2" (165mm)		50	50	52	52	
1 3/4" (45mm)	10" (250mm)		52	52	52	56	
1 3/4" (45mm)	14" (350mm)			56	56	60	2 3/4" (70mm)
1 3/4" (45mm)	16" (400mm)			60	60	60	
			55	55	55	65	
2" (50mm)	7" (175mm)		50	52	52	52	2 3/4" (70mm)
2" (50mm)	10" (250mm)		52	52	52	56	
2" (50mm)	14" (350mm)			56	56	60	
2" (50mm)	16" (400mm)			60	60	60	2 3/4" (70mm)
2" (50mm)	19" (475mm)			60	60	60	
		2" (50mm)	50	52	56	56	
2 3/4" (70mm)	8" (200mm)		55	65	65	65	2 3/4" (70mm)
2 3/4" (70mm)	10" (250mm)		52	52	52	56	
2 3/4" (70mm)	13 1/2" (340mm)			56	56	60	
		2 1/2" (65mm)	56	56	72	72	4" (100mm)
		2 3/4" (70mm)		56	72	72	
			52	52	56	56	
3 1/2" (90mm)	7" (175mm)			52	56	56	4" (100mm)
3 1/2" (90mm)	8" (200mm)			52	56	72	
3 1/2" (90mm)	10" (250mm)			56	56	72	
3 1/2" (90mm)	12 1/2" (315mm)			56	60	60	4" (100mm)
		3 1/2" (90mm)		56	62	62	
					75	75	
4" (100mm)	5 1/2" (140mm)		52	52	52	56	5" (125mm)
4" (100mm)	7 1/2" (190mm)			56	56	72	
4" (100mm)	10 1/2" (265mm)				62	62	
4 3/8" (110mm)	5" (125mm)		52	52	56	56	5" (125mm)
4 3/8" (110mm)	7" (175mm)			56	72	72	
4 3/8" (110mm)	10" (250mm)			62	62	62	
4 3/4" (120mm)	4 1/2" (115mm)		52	52	56	56	5" (125mm)
4 3/4" (120mm)	6" (150mm)			56	60	60	
4 3/4" (120mm)	9" (225mm)			60	62	62	
					85	85	6 1/2" (165mm)
				72	72	72	
				60	60	60	
5" (125mm)	4" (100mm)				60	60	6 1/2" (165mm)
5" (125mm)	5" (125mm)			72	72	72	
5" (125mm)	7" (175mm)				60	60	
6" (150mm)	3" (75mm)			72	72	72	6 1/2" (165mm)
6" (150mm)	5 1/2" (140mm)				72	72	
					85	85	
6 1/2" (165mm)	5" (125mm)				72	72	

CENTECH RADIAL/OTR NON-REPAIRABLE AREA

14.00-16.00 (15.5-17.5)	3", 75mm
18.00-24.00 (20.5-29.5)	5", 125mm
27.00-33.00 (33.25-37.5)	6", 150mm
40/65-50/65 (40.5)	6 3/4", 170mm
36.00	8", 200mm
37.00-40.00 (50.5 & larger)	10", 255mm

DETERMINING CROWN INJURY REPAIR AREA

Radial/OTR Crown Dimensions

Crown is defined as 50% of tread face for standard aspect ratio tire sizes and 60% of tread face for wide base sizes. All measurements are taken on the outside surface of the tire.

Standard Aspect Tire Size Example (24.00 R35):

If the tread face measures 24" (610mm) wide, 50% of that is 12" (300mm) - the crown area measurement, or 6" (150mm) on each side of the tread centerline. This is where the injury must be located to be considered as a crown area repair.

Wide Base Tire Size Example (29.5 R29):

If the tread face measures 25" (635mm) wide, 60% of that is 15" (375mm) - the crown area measurement, or 7.5" (190mm) on each side of the tread centerline. This is where the injury must be located to be considered as a crown area repair.

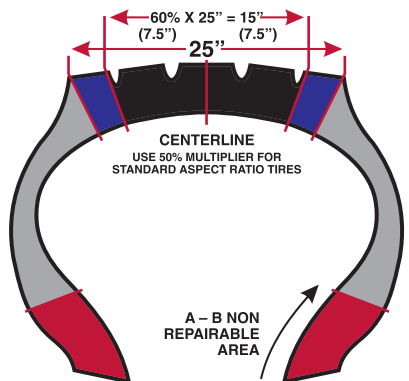

Repair Unit	Inches	Millimeters
CT42	5 x 10	125 x 250
CT44	5 x 13	125 x 330
CT45	9 1/8 x 7 3/4	230 x 195
CT46	5 1/2 x 16	140 x 405
CT50	7 1/2 x 19 3/4	190 x 500
CT52	10 x 22 1/2	250 x 570
CT55	13 x 10 1/4	330 x 260
CT56	10 1/2 x 29	265 x 735
CT60	10 1/2 x 34	265 x 860
CT62	12 3/4 x 40 1/2	325 x 1030
CT65	16 1/2 x 13	420 x 330
CT72	13 3/4 x 30	345 x 760
CT75	20 3/4 x 17 3/4	535 x 450
CT85	28 x 22	710 x 560

REPAIR UNITS SHOWN **BOXED IN RED** ARE LIMITED TO CROWN (T-T) AREA ONLY. ALL OTHERS SHOWN IN **RED** MAY BE USED FOR CROWN, SHOULDER OR SIDEWALL INJURIES.
NOTE: THIS SECTION REPAIR CHART IS A GUIDELINE ONLY. INCREASE REPAIR UNIT BY ONE (1) SIZE FOR TIRES USED IN SEVERE APPLICATIONS SUCH AS HAULAGE TRUCKS AND SCRAPERS. LOAD, SPEED AND HIGHWAY APPLICATION CAN AFFECT THE LIMITATIONS OF SECTION REPAIRS.

AX Aramid Reinforced Radial OTR Repair Chart Severe Service Repairs

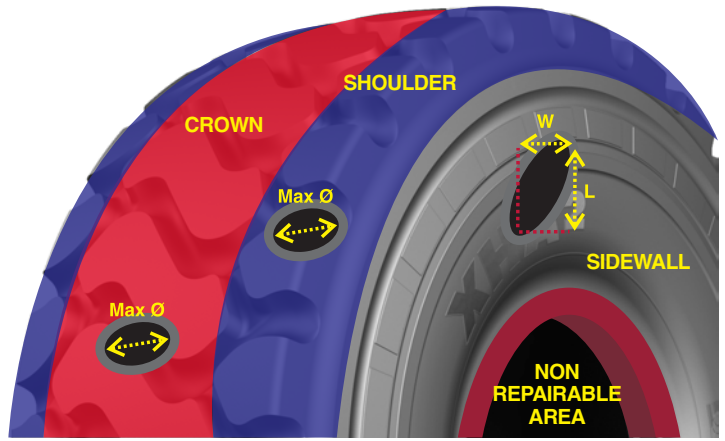

Sidewall Injury		Shoulder Injury	Earthmover Tire Sizes				Crown Injury
			Inner liner removed on all severe service applicators				
Width inches (mm)	Length inches (mm)	Diameter inches (mm)	18.00-21.00 20.5-26.5	24.00-27.00 29.5-33.5 35/65	30.00-33.00 37.25-37.50 40/65-45/65	36.00-40.00 46/90-59/80 50/65-65/65	Diameter inches (mm)
1 (25)	10 (250)	1 (25)	CT45A	CT45A	CT45A	CT45A	1 (25)
	1 1/4 (30mm)		AX50	AX60	AX80		
1 1/2 (40)	12 (300)	1 1/2 (40)	AX50	AX60	AX80		
	14 (350)		CT45A	CT55A	CT55A	CT55A	1 1/2 (40)
1 1/2 (40)	16 (400)	1 1/2 (40)	AX80	AX80	AX80		
			AX100	AX100	AX100	AX120	
2 (50)	8 (200)	2 (50)	CT55A	CT55A	CT55A	CT65A	2 (50)
	11 (275)		AX50	AX80	AX100	AX120	
2 (50)	14 (350)	2 (50)	AX60	AX80	AX100	AX120	
	18 (450)		AX120	AX120	AX120	AX140	
2 (50)	19 (475)	2 (50)	AX140	AX140	AX140	AX155	
	22 1/2 (570)		AX50	AX80	AX120	AX140 OR AX155*	
2 3/8 (60)	18 (450)	2 1/2 (65)	CT55A	CT65A	CT65A	CT65A	2 1/2 (65)
	6 (150)		AX50	AX80	AX100	AX140	
2 1/2 (65)	14 (350)	2 1/2 (65)	AX100	AX120	AX120	AX140	
			AX50	AX100	AX140	AX140 or AX155*	
2 3/4 (70)	16 (405)	3 (75)	CT65A	CT75A	CT75A	CT75A	3 (75)
	5 1/2 (140)		AX50	AX80	AX100	AX140	
3 (75)	11 (275)	3 (75)	AX100	AX120	AX120	AX140	
	12 (300)		AX120	AX120	AX120	AX140	
3 (75)	16 (400)	3 (75)	AX120	AX120	AX120	AX155	
			AX60	AX100	AX140	AX140 or AX155*	
3 1/4 (85)	16 1/2 (420)	3 1/2 (90)	AX140	AX140	AX140	AX155	
			CT75A	CT75A	CT75A	CT75A	3 1/2 (90)
3 1/2 (90)	7 1/2 (190)	3 1/2 (90)	AX60	AX80	AX120	AX120	
	9 (225)		AX80	AX100	AX120	AX120	
3 1/2 (90)	12 (300)	3 1/2 (90)	AX120	AX120	AX120	AX140	
			CT75A	CT75A	CT75A	CT75A	4 (100)
4 (100)	5 (125)	4 (100)	AX60	AX100	AX120	AX140	
	6 (150)		AX100	AX100	AX120	AX140	
4 (100)	9 (225)	4 (100)	AX100	AX100	AX120	AX140	
	11 (275)		AX120	AX120	AX120	AX155	
4 1/2 (115)	6 1/2 (165)	4 1/2 (115)	AX80	AX100	AX120	AX140	
	6 (150)		AX80	AX120	AX120	AX140	
4 3/4 (120)	10 1/2 (265)	4 3/4 (120)	AX140	AX140	AX140	AX140	
			CT85A	CT85A	CT85A	CT85A	5 (125)
5 (125)	5 (125)	5 (125)	AX120	AX120	AX120	AX140	
	7 (175)		AX120	AX120	AX120	AX140	
6 (150)	3 (75)	6 (150)	AX120	AX140	AX140	AX140	
	5 (125)		AX140	AX140	AX140	AX140	5 1/2 (140)

RADIAL/OTR NON-REPAIRABLE AREA

14.00-16.00 (15.5-17.5)	3", 75mm
18.00-24.00 (20.5-29.5)	5", 125mm
27.00-33.00 (33.25-37.5)	6", 150mm
40/65-50/65 (40.5)	6 3/4", 170mm
36.00	8", 200mm
37.00-40.00 (50.5 & larger)	10", 255mm

DETERMINING CROWN INJURY REPAIR AREA (T-T AREA)

Radial/OTR Crown Dimensions (T-T Area)

Crown is defined as 50% of tread face for standard aspect ratio tire sizes and 60% of tread face for wide base sizes. All measurements are taken on the outside surface of the tire.

Standard Aspect Tire Size Example (24.00 R35):

If the tread face measures 24" (610mm) wide, 50% of that is 12" (300mm) - the crown area measurement, or 6" (150mm) on each side of the tread centerline. This is where the injury must be located to be considered as a crown area repair.

Wide Base Tire Size Example (29.5 R29):

If the tread face measures 25" (635mm) wide, 60% of that is 15" (375mm) - the crown area measurement, or 7.5" (190mm) on each side of the tread centerline. This is where the injury must be located to be considered as a crown area repair.

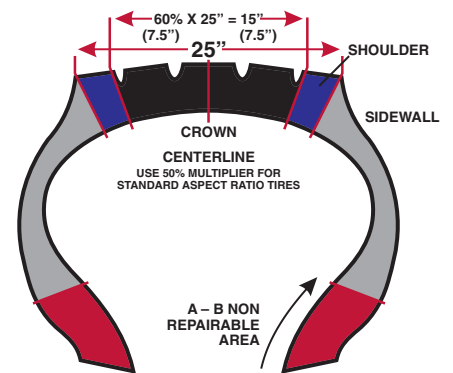

Repair Unit	REPAIR UNIT DIMENSIONS	
	inches	mm
CT45A	9 1/8 X 7 3/4	230 X 195
CT55A	13 X 10 1/4	330 X 260
CT65A	16 1/2 X 13	420 X 330
CT75A	20 3/4 X 17 X 3/4	535 X 450
CT85A	28 X 22	710 X 560
AX50	5 1/2 x 20 1/2	140 x 520
AX60	8 1/2 x 24	215 x 610
AX80	9 1/2 x 28	240 x 710
AX100	11 x 31	280 x 790
AX120	11 x 35	280 x 890
AX140	14 1/2 x 47	370 x 1190
AX155	10 x 55	250 x 1400

*USE THE AX140 ON 57" TIRES AND THE AX155 ON 63" TIRES.

REPAIR UNITS SHOWN [BOXED IN RED] ARE LIMITED TO CROWN (T-T) AREA ONLY.
NOTE: THIS SECTION REPAIR CHART IS A GUIDELINE ONLY.

TECH Off Road (TOR) Bias OTR Repairs

Tech TOR's repair injuries up to 11", 275mm in 60plus ply rated tires. One-piece construction reduces repair costs and increases productivity by providing easier installation, eliminating the need for piggybacking repairs. Specially designed plies dissipate stress and provide maximum flexibility and strength. Advanced rubber compounding throughout the repair construction resists over cure and flex fatigue when the tire is returned to service. Tech is pleased to offer a complete line of TOR repairs suited for every type of curing system in the industry.

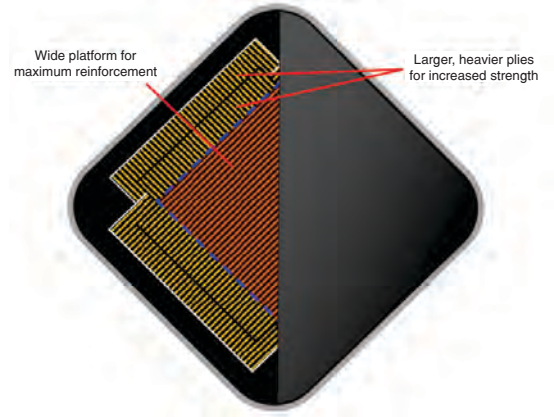

TOR CHEMICAL REPAIRS

TOR Chemical repairs with gray chemical cushion gum are recommended for tires vulcanized with spotters or press systems. The repair unit is installed with Tech Chemical Vulcanizing Fluid or Heavy Duty Blue Cement after the filler rubber has been cured.



TOR THERMACURE REPAIRS

TOR Thermacure repairs with soft black cushion gum are recommended for tires cured with spotters, press systems, section molds or Monaflex systems. Thermacure repair units should be installed with Tech Heavy Duty Blue Cement after the filler rubber has been cured. In heat cure applications the repair unit may also be installed using Tech Tem-Vulc Black Cement.



TOR CLOTH BACKED REPAIRS

TOR Cloth Backed repairs are produced on a special cloth backing material. When removed, this provides optimum bonding surface texture. For best results, use with Tech Tem-Vulc Black Cement and Vul-Gum cushion gum. Cloth backed repairs have a 5 year shelf life.

TECH Off Road (TOR) Bias OTR Repairs

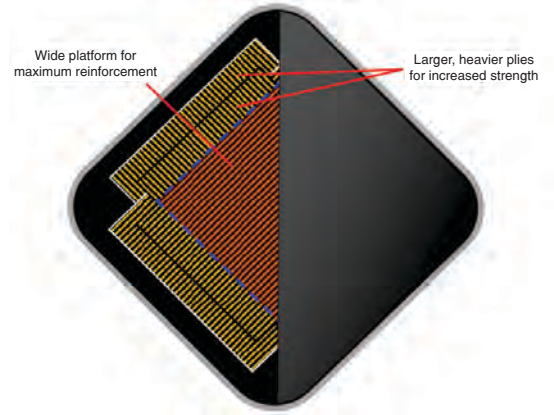

TOR HEAT CURE REPAIRS

TOR Heat Cure repairs produced with black heat cure cushion gum are recommended for all heat cure vulcanizing systems. The special heat cure gum resists over cure during section repairs requiring extended cure times. For best results, use with Tech Tem-Vulc Black Cement.



TOR UNCURED REPAIRS

TOR Uncured repairs provide excellent adhesion and appearance when vulcanized in autoclaves section molds, or with a Monaflex system. Uncured TORs are ready to be installed or can be floated in the tire. For best results use, Tech Tem-Vulc Black Cement.

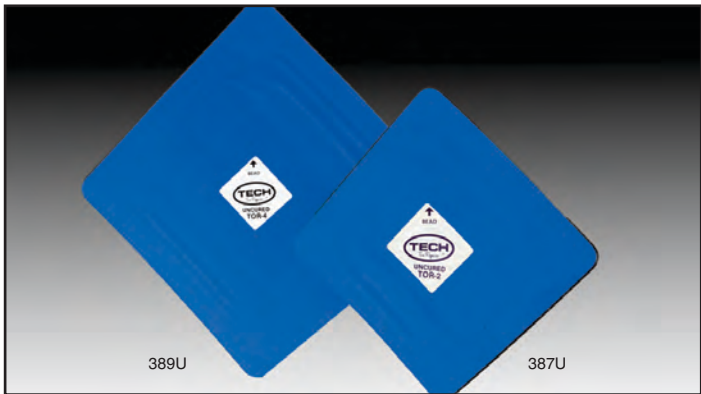

BIAS TOR REPAIRS

Chemical Repair Cat. No.	Thermacure Repair Cat. No.	Heat Cure Repair Cat. No.	Cloth Back Repair Cat. No.	Uncured Repair Cat. No.	Diagonal Dimension inches	Diagonal Dimension mm	Plies	Box Quantity
TOR1	TOR1R	TOR1H	TOR1C	TOR1U	9 3/4	250	2	10
TOR2	TOR2R	TOR2H	TOR2C	TOR2U	11 1/2	290	4	10
TOR3	TOR3R	TOR3H	TOR3C	TOR3U	12 1/4	310	4	5
TOR4	TOR4R	TOR4H	TOR4C	TOR4U	15	380	6	5
TOR5	TOR5R	TOR5H	TOR5C	TOR5U	18 3/4	475	6	5
TOR6	TOR6R	TOR6H	TOR6C	TOR6U	21 3/8	545	6	3
TOR7	TOR7R	TOR7H	TOR7C	TOR7U	24 1/4	615	8	1
TOR8	TOR8R	TOR8H	TOR8C	TOR8U	27 1/4	690	8	1
TOR9	TOR9R	TOR9H	TOR9C	TOR9U	30	760	10	1
TOR10	TOR10R	TOR10H	TOR10C	TOR10U	32 3/4	830	10	1
TOR11	TOR11R	TOR11H	TOR11C	TOR11U	34 1/4	870	10	1

TECH Off Road (TOR) & Bias Skidder Repair Chart

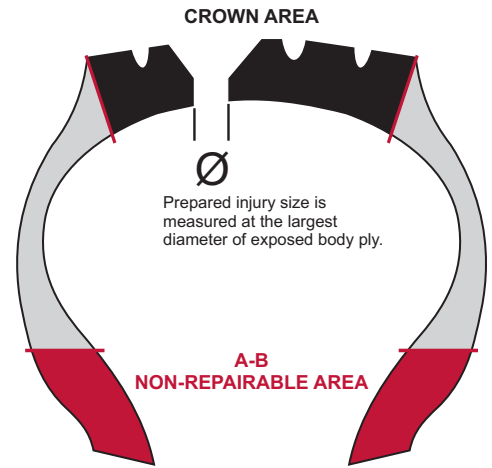

CHART INSTRUCTIONS: For proper repair unit selection, determine the size of the injury in the tire by measuring largest cord area removed. Locate the correct injury size along the top row of the chart. Now locate the tire's ply rating (load range) along the left column of the same chart. The repair unit number shown in the box where these intersect is the correct repair unit to use.

NOTE: THIS SECTION REPAIR CHART IS ONLY A GUIDELINE. LOAD, SPEED AND APPLICATION OF THE TIRE CAN AFFECT THE LIMITATIONS OF SECTION REPAIRS.

BIAS SKIDDER TIRE (SK) REPAIR CHART



PREPARED INJURY SIZE

PLY RATING (LOAD RANGE)	Inches mm	4" 100	5" 125	6" 150	7" 175	8" 200	9" 225	10" 250	11" 275	12" 300
	10-12	12	12	12	16	16	20	20	24	24
14-16	12	12	16	20	20	20	24	24	24	24
18-20	12	16	20	20	20	24	24	24	24	24
22-24	16	20	20	24	24	24	24	TOR9*	TOR9*	
26-28	TOR5	TOR6	TOR7	TOR7	TOR8	TOR8	TOR9	TOR9*	TOR10*	

FOR 6 TO 8 PLY RATED TIRES AND INJURIES SMALLER THAN SHOWN ON THIS CHART, REFER TO BPT CHART ON PAGE 13. *CROWN AREA INJURIES ONLY.

SKIDDER A-B NON-REPAIRABLE AREA

Section Width	Dimension
14.9-20.8	4", 100mm
23.1 & larger	5", 125mm

OTR A-B NON-REPAIRABLE AREA

Section Width	Dimension
14.00 & smaller (15.5-17.5)	4", 100mm
16.00-18.00 (20.5-23.5)	5", 125mm
21.00-24.00 (26.5-33.25)	6", 150mm
27.00-33.00 (33.5-37.5)	8", 200mm
40/65-65/65	10", 250mm
36.00-40.00	12", 300mm

BIAS OTR TIRE (TOR) REPAIR CHART



PREPARED INJURY SIZE

CROWN INJURIES ONLY

PLY RATING (LOAD RANGE)	Inches mm	1/2" 13	1" 25	1.5" 40	2" 50	2.5" 65	3" 75	4" 100	5" 125	6" 150	7" 175	8" 200	9" 225	10" 250	11" 275	12" 300
	6-8	1	2	2	2	2	3									
10-12	1	2	2	2	2	3	4									
14-16	1	2	2	3	3	4	4	4	5							
18-20	2	2	2	3	3	4	4	5	5	6						
22-24	2	2	2	3	3	4	5	5	6	7	7	8				
26-28	2	2	3	3	4	5	5	6	7	7	8	8	9	9	10	
30-36	2	2	3	3	4	5	6	6	7	8	9	9	9	10	10	
38-44	2	2	3	3	4	6	6	7	8	8	9	9	10	10	10	
46-50	2	3	4	4	5	6	7	8	8	9	10	10	11	11	11	
52-58	3	3	4	4	5	6	7	8	8	10	10	11	11	11	11	
60+	3	4	5	5	6	7	8	8	9	10	11	11	11	11		

TECH Rope Rubber

Tech TRR and LRR rope rubber are produced with a high quality natural rubber compound which provides excellent extrusion and workability, maximum adhesion to the tire, and outstanding wear and weather resistance. Tech rope rubber is packaged in 15 pound plastic pails for maximum protection during transport and storage.

TECH ROPE RUBBER



Cat. No.	Description	Specifications	Pkg. Qty.
LRR	ROPE RUBBER 3/8" (10mm) diameter for sidewall applications	RMA Cure Class 20C Shore Hardness 60+/- 3 Tensile 2700 minimum Modulus 800 minimum Elongation 400 minimum	15 lbs., 6.8kg
TRR	ROPE RUBBER 3/8" (10mm) diameter for tread applications	RMA Cure Class 20C Shore Hardness 65+/- 3 Tensile 2700 minimum Modulus 1100 minimum Elongation 450 minimum	15 lbs., 6.8kg
S182	EXTRUDER GUN	110V (220V available by special order)	1

TECH Vul-Gum

Tech Vul-Gum cushion gum natural rubber compound provides excellent adhesion to prepared rubber surfaces. Suitable for floating repair units, filling skives, or spot repairs. RMA cure class 20A, 20 minutes at 280°F (138°C).

VUL-GUM CUSHION GUM

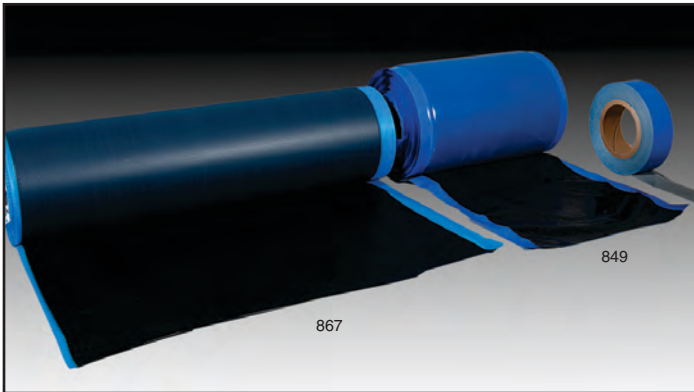

Cat. No.	Gauge & Width (mm / inches)	Weight/Roll (kg / lb.)	Rolls/ Box
849	6 x 150 / 1/4 x 6	4.5 / 10	1
850	3 x 150 / 1/8 x 6	4.5 / 10	1
862	3 x 475 / 1/8 x 19	6.8 / 15	1
867	1.5 x 475 / 1/16 x 19	6.8 / 15	1
868	0.8 x 475 / 1/32 x 19	6.8 / 15	1
869	3 x 750 / 1/8 x 30	6.8 / 15	1
870	1.5 x 750 / 1/16 x 30	6.8 / 15	1

VUL-GUM STRIPPING STOCK

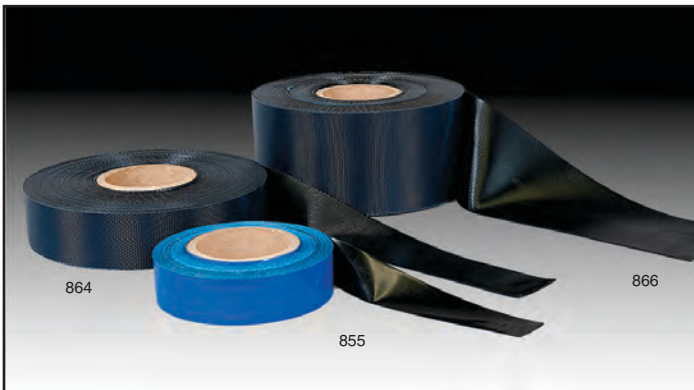

Cat. No.	Gauge & Width (mm / inches)	Weight/Roll (kg / lb.)	Rolls/ Box
855	0.4 x 40 / 1/64 x 1 1/2	0.5 / 1	5
861	3 x 25 / 1/8 x 1	0.9 / 2	9
863	1.5 x 25 / 1/16 x 1	0.9 / 2	9
864	1.5 x 50 / 1/16 x 2	1.8 / 4	4
865	1.5 x 75 / 1/16 x 3	2.7 / 6	3
866	1.5 x 100 / 1/16 x 4	3.6 / 8	2

TECH Fabric Reinforced Rubber

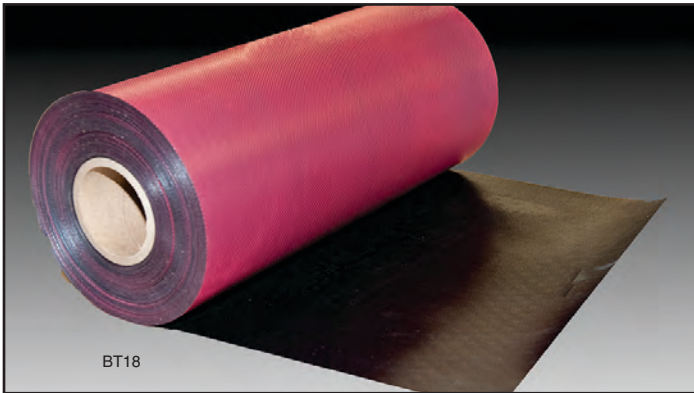

FABRIC REINFORCED RUBBER CUSHION GUM

Cat. No.	Description	Gauge & Width (mm / inches)	Weight/Roll (kg / lb.)	Rolls/Box
BT18	Square Woven Nylon	1.5 x 425 / 1/16 x 19	11.5 / 25	1
BN18	1 Ply Nylon Cord	0.8 x 425 / 1/32 x 19	11.5 / 25	1
TCG	1 Ply Nylon Cord	0.8 x 660 / 1/32 x 26	11.5 / 25	1

TECH Butyl Gum & Chemical Cure Rubber

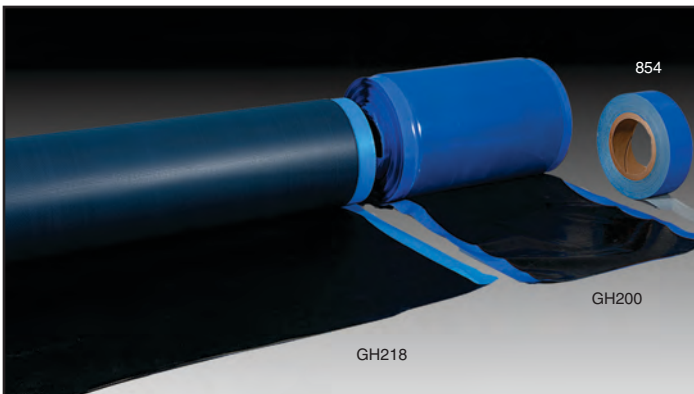

HEAT CURE INNER LINER REPAIR GUM

Cat. No.	Description	Gauge & Width (mm / inches)	Weight/Roll (kg / lb.)	Rolls/Box
BTLG-125/10#	Butyl Gum	0.8 x 425 / 1/32 x 19	4.5 / 10	1
848	Butyl Gum	0.8 x 100 / 1/32 x 4	4.5 / 10	1

CHEMICAL CURE INNER LINER REPAIR GUM

Cat. No.	Description	Gauge & Width (mm / inches)	Weight/Roll (kg / lb.)	Rolls/Box
GH100	Chemical Cushion Gum	0.8 x 150 / 1/32 x 6	2.72 / 6	1
GH200	Chemical Cushion Gum	0.8 x 225 / 1/32 x 9	5 / 11	1
GH218	Chemical Cushion Gum	0.8 x 450 / 1/32 x 18	5 / 11	1

CHEMICAL CURE STRIPPING STOCK

Cat. No.	Description	Gauge & Width (mm / inches)	Weight/Roll (kg / lb.)	Rolls/Box
854	Gray Chemical Gum	0.4 x 25 / 1/64 x 1	0.5 / 1	5

TECH A & B Compound



A&B Compound is a two part self vulcanizing rubber compound for bead, spot, and section repairs. For best results, use with Tech #760 Chemical Vulcanizing Fluid or #775 Heavy Duty Blue Cement.

A & B COMPOUND TWO-PART CHEMICAL CURE FILLER RUBBER

Cat. No.	Description
858	A & B COMPOUND, set of two 0.5kg, 1 lb. cans
859	A & B COMPOUND, set of two 0.9kg, 2 lb. cans

TECH Tire Repair Chemicals

Tech Chemical Vulcanizing Fluid and Rub-O-Matic contain no CFC's and are more environmentally friendly than chemicals with CFC's. Rub-O-Matic removes contamination from the inner liner quickly and easily. Tech's Atomizer is a refillable, rechargeable sprayer which uses clean, dry air as the propellant for Tech chemicals. Fast-drying Tech Chemical Vulcanizing Fluid cures tire and tube repairs with or without heat.



Heavy Duty Blue Vulcanizing Fluid is an extra thick vulcanizing fluid for hot or cold application. This formula works well with single coat coverage when applying large bias or radial repairs in tubeless or tube-type tires, and for any hard gum repair applications.

Tech offers both solvent-based and water-based inner liner repair sealants, which restore overbuff areas on tubeless tire inner liners. Tech-Chek concentrate detects hard to locate leaks.

RUB-O-MATIC

Cat. No.	Description
704	RUB-O-MATIC, 1qt., 945ml can
704A	RUB-O-MATIC, in aerosol spray can, 11.75 oz., 336g
704G	RUB-O-MATIC, 1 gal., 3.8 liter can
704-5G	RUB-O-MATIC, 5 gal., 19 liter
704-55G	RUB-O-MATIC, 55 gal., 209 liter
705C	TECH CITRUS-BASED RUBBER CLEANER, 32 oz., 945ml can
975	ATOMIZER, 16 oz., 453.6g refillable sprayer

TECH VULCANIZING FLUIDS

Cat. No.	Description
760	CHEMICAL VULCANIZING FLUID, 7.8 oz., 230ml can with brush cap
761	CHEMICAL VULCANIZING FLUID, 1 qt., 945ml can
762	CHEMICAL VULCANIZING FLUID, 1 gal., 3.8 liter
765*	CHEMICAL VULCANIZING FLUID, 50ml tube, box of 24
766*	CHEMICAL VULCANIZING FLUID, 20ml tube, box of 24
767*	CHEMICAL VULCANIZING FLUID, 10ml tube, box of 24
768	FLOW SEAL VULCANIZING FLUID, 8 oz., 235ml can with brush cap
770	FLOW SEAL VULCANIZING FLUID, 7 oz., 205ml with flip top dispenser

*All tubes of Tech Chemical Vulcanizing Fluid come packaged in self-merchandising display cartons. Sold in full box quantities of 24 only.

TECH VULCANIZING FLUIDS

Cat. No.	Description
775	HEAVY DUTY BLUE VULCANIZING FLUID 8 oz., 235ml can with brush cap
776	HEAVY DUTY BLUE VULCANIZING FLUID 1 qt., 945ml can with brush cap
777	HEAVY DUTY BLUE VULCANIZING FLUID, 1 gal., 3.8 liter
1082	TEMVULC brush type vulcanizing and retread cement for heat vulcanizing applications. 1 qt., 945ml can
1082G	TEMVULC BLACK CEMENT, 1 gal., 3.8 liter
1082-5G	TEMVULC BLACK CEMENT, 5 gal., 19 liter
1082-55G	TEMVULC BLACK CEMENT, 55 gal., 209 liter
968LB	ALUMINUM CEMENT DISPENSER with long brush, 1 qt., 945ml
968RLB	REPLACEMENT LID AND BRUSH for 968LB

TECH CHEMICALS

Cat. No.	Description
738	SECURITY COAT overbuff inner liner sealant, 16 fl. oz., 470ml
738G	SECURITY COAT, 1 gal., 3.8 liter
739	BUTYL LINER REPAIR SEALER, 32 oz., 945ml can with brush cap
706-1	TIRE TALC, 1 lb., .5kg
751	TECH-CHEK concentrate, 1 qt., 945ml bottle
751-5G	TECH-CHEK concentrate, 5 gal., 19 liter
751-55G	TECH-CHEK concentrate, 55 gal., 209 liter
969	SPRAY BOTTLE, 16 oz., 470ml

TECH

2-Way Tube Repairs* & All Purpose Repairs

Tech 2-Way tube repairs are the finest made today. Every repair is permanent and safe, and the repair is twice as strong as the tube itself. Tech makes round and oval repairs for any size injury, on or off the road. Tech is the pioneer of self-vulcanizing repairs, so you can depend on high quality Tech repairs throughout the line.

Tech All-Purpose repairs are designed for use in radial and bias tires. New compounding and thicker rubber helps to resist dimpling. Tech All-Purpose repairs can also be used for tube repairing.

*Patent No. 2,582,770



ROUND 2-WAY TUBE REPAIRS

Cat. No.	Description	Dim. (mm)	Dim. (inches)	Box Qty.
09	TINY ROUND	25	1	140
10	MINI ROUND	35	1 ³ / ₈	50
11	SMALL ROUND	45	1 ³ / ₄	40
12	MEDIUM ROUND	60	2 ¹ / ₄	30
13	LARGE ROUND	80	3 ¹ / ₈	20
14	MAXI ROUND	100	4	20
15	GIANT ROUND	125	5	10
10T	MINI ROUND TUB	35	1 ³ / ₈	200
11T	SMALL ROUND TUB	45	1 ³ / ₄	160
12T	MEDIUM ROUND TUB	60	2 ¹ / ₄	100
13T	LARGE ROUND TUB	80	3 ¹ / ₈	75



OVAL 2-WAY TUBE REPAIRS

Cat. No.	Description	Dim. (mm)	Dim. (inches)	Box Qty.
16	MINI OVAL	40 x 30	1 ¹ / ₂ x 1 ¹ / ₈	100
17	SMALL OVAL	65 x 40	2 ¹ / ₂ x 1 ¹ / ₂	30
18	MEDIUM OVAL	100 x 50	4 x 2	20
19	LARGE OVAL	150 x 70	6 x 2 ³ / ₄	20
20	GIANT OVAL	160 x 100	6 ¹ / ₄ x 4	10
16T	MINI OVAL TUB	40 x 30	1 ¹ / ₂ x 1 ¹ / ₈	200
17T	SMALL OVAL TUB	65 x 40	2 ¹ / ₂ x 1 ¹ / ₂	120

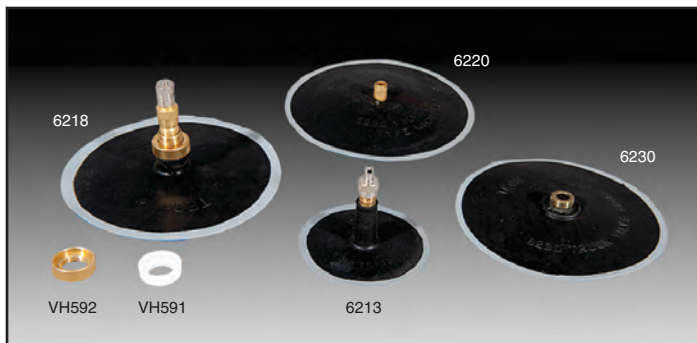

TUBE REPLACEMENT VALVES

Cat. No.	TR No.	Description	Box Qty.
6213	13	PASSENGER VALVE for .453 rim hole, 2 ¹ / ₂ ", 63mm base diameter	10
6214	-	RIM HOLE BUSHING for .625 rim hole, protects tube valve	50
6218	218	AIR/LIQUID TRACTOR VALVE 4 ¹ / ₄ ", 110mm base diameter	10
6220	-	MICHELIN VALVE SPUD 4 ¹ / ₄ ", 110mm base diameter	5
6230	-	TRUCK VALVE SPUD 4 ¹ / ₄ ", 110mm base diameter	5
VH591	-	PLASTIC RIM NUT for 6218	
VH592	-	BRASS RIM NUT for 6218	



TECH ALL-PURPOSE REPAIRS

Cat. No.	Description	Dim. (mm)	Dim. (inches)	Box Qty.
111	AP8 ROUND ALL PURPOSE	65	2 ¹ / ₂	50
115	AP4.5 SQUARE ALL PURPOSE	45	1 ³ / ₄	100
116	AP6 SQUARE ALL PURPOSE	55	2 ¹ / ₄	80
117NB	NAIL BUSTER double pack	Contains [40] 115 All Purpose square repairs and [30] 116 All Purpose square repairs		

TECH Permacure® Inside/Outside Reinforced Repairs & Repair Kits

Tech Permacure repairs utilize an exclusive nylon reinforced design that makes applying repairs easier, virtually eliminating cutting and resulting in less labor time and a durable repair, which permanently vulcanizes through the tire injury.

Tech's unique cushion gum flows and cures into cracks and crevices, and actually vulcanizes to the tire itself. Permacure II repair units are excellent for smaller injuries.

Permacure and Permacure II repairs can be used in the crown of all radial and bias tubeless passenger and truck tires - as well as the crown, shoulder and sidewall areas of all radial and bias tubeless agricultural, ATV and off-the-road tires.

Permacure repairs can be used as an injury filler material and then backed up with the appropriate repair unit.

Note: Industry recommendations state that the tire should be demounted and repaired from the inside using suitable rubber vulcanizing material and appropriate repair unit on the inner liner.



PERMACURE & PERMACURE II REPAIRS

Cat. No.	Description	Box Qty.
220	PERMACURE II REPAIRS, 3¾", 95mm	50
222	PERMACURE REPAIRS, 3¾", 95mm	50
911	PERMACURE WRENCH, 2mm	
915	SPIRAL CEMENT TOOL	
925	PERMACURE PASSENGER TOOL	
926	PERMACURE PASSENGER REPLACEMENT NEEDLE	



PERMACURE TRUCK REPAIRS

Cat. No.	Description	Box Qty.
224	PERMACURE REPAIRS, 5½", 130mm	40
270	CARBIDE CUTTER	
911	PERMACURE WRENCH, 2mm	
915	SPIRAL CEMENT TOOL	
925T	PERMACURE TRUCK TOOL	
927	PERMACURE TRUCK REPLACEMENT NEEDLE	

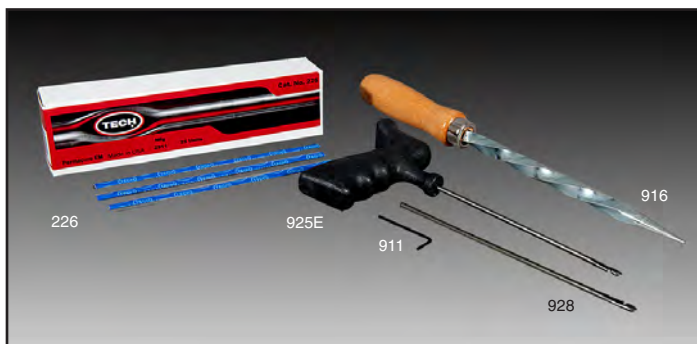

PERMACURE EARTHMOVER REPAIRS

Cat. No.	Description	Box Qty.
226	PERMACURE REPAIRS, 7½", 190mm	25
911	PERMACURE WRENCH, 2mm	
915	SPIRAL CEMENT TOOL	
916	GIANT SPIRAL CEMENT TOOL	
925E	PERMACURE EARTHMOVER TOOL	
928	PERMACURE EARTHMOVER REPLACEMENT NEEDLE	



PERMACURE KITS

- No. 215 PERMACURE REPAIR KIT BOX** contains:
- No. 220/222 Combination box of Permacure repairs contains [25] 220 Permacure II repairs and [25] 222 Permacure repairs
 - No. 770 Flow-Seal Vulcanizing Fluid
 - No. 911 Permacure Wrench, 2mm
 - No. 915 Spiral Cement Tool
 - No. 925 Permacure Tool w/Passenger Needle
 - No. 926 Permacure Passenger Replacement Needle



- No. 216 PERMACURE TRUCK REPAIR KIT BOX** contains:
- No. 224 Permacure repairs
 - No. 770 Flow-Seal Vulcanizing Fluid
 - No. 911 Permacure Wrench, 2mm
 - No. 915 Spiral Cement Tool
 - No. 925T Permacure Tool w/Truck Needle
 - No. 927 Permacure Truck Replacement Needle



TECH Flow-Seal® Inserts, Self-Vulcanizing Inside/Outside Repairs

You can repair small injuries in tubeless tires fast and easy with Tech Flow-Seal Inserts. Unique gray cushion gum flows into the injury and completely seals the inner liner as well as broken cord and cable ends. The insert permanently vulcanizes through the injury. The tire is immediately ready for use. Flow-Seal inserts are ideal for use in both bias and steel belted radial tires.

Tech Flow-Seal Inserts are designed for demounted tires and can be used to fill an injury and are very effective when backed up with the appropriate repair unit.

Tech Insert-O-Matic tool (Cat. No. 920) and Insert-O-Mates (Cat. No. 203) make inserting repairs fast and easy. Insert-O-Mates fit on the end of the Insert-O-Matic tool, allowing the insert to be easily applied into the tire.

Note: Industry recommendations state that the tire should be demounted and repaired from the inside using suitable rubber vulcanizing material and appropriate repair unit on the inner liner.



Actual cross-section photo of an insert in a steel belted radial tire that was run 50,000 miles (81,000km) on a test wheel. The repair unit was still securely in place and tire remained leak-free.



FLOW-SEAL INSERTS

Cat. No.	Description	Box Qty.
203	INSERT-O-MATE PLASTIC TIPS	20
204	ROUND INSERTS, 2", 50mm	40
206	OVAL INSERTS, 2", 50mm	40
903	STEEL T-HANDLE CUTTER	
903RC	REPLACEMENT STEEL CUTTER	
915	SPIRAL CEMENT TOOL	
920	INSERT-O-MATIC TOOL	
921	PASSENGER REPLACEMENT NEEDLE	



FLOW-SEAL INSERTS

Cat. No.	Description	Box Qty.
208	ROUND TRUCK INSERTS, 3¾", 95mm	20
209	OVAL TRUCK INSERTS, 3¾", 95mm	40
903	STEEL T-HANDLE CUTTER	
903RC	REPLACEMENT STEEL CUTTER	
920	INSERT-O-MATIC TOOL	
923	INSERT-O-MATIC TRUCK NEEDLE	



NOTE: When applying 208 and 209 inserts, the 923 truck needle must replace 921 needle which comes in a 920 Insert-O-Matic Tool.



FLOW-SEAL INSERTS

Cat. No.	Description	Box Qty.
211	ROUND INSERTS, 7½", 190mm	25
212	OVAL INSERTS, 9", 225mm	15
217	GIANT OVAL INSERTS, 8¼", 210mm	10
905	HEAVY DUTY INSERT TOOL, 9", 225mm	
916	GIANT SPIRAL CEMENT TOOL	



TECH Repair Kits

NAILHOLE INSERTS & REPAIR KITS



Tech offers an exciting array of repair kits, each designed for a specific repair application. Each kit contains all the necessary products to assure a complete, permanent repair.

MOTORCYCLE, ATV & TIRE REPAIR KITS

No. 880 MOTORCYCLE TUBELESS TIRE REPAIR KIT for shop use, contains:

- 1 Box – No. 249UL Uni-Seal Ultras
 - 1 Box – No. 250UL Uni-Seal Ultras
 - 1 – No. 261 Uni-Seal cutter
 - 1 – No. 704A Rub-O-Matic
 - 1 – No. 760 Chemical Vulcanizing Fluid
 - 1 – No. 915 spiral cement tool
 - 1 – No. 933 rubber scraper
 - 1 – No. 935 stitcher/buffer
- Packed in a heavy-duty plastic box with handle

No. 885 ATV REPAIR KIT contains:

- 8 – No. 220 Permasure repairs
- 2 – 16g CO2 cartridges*
- Brass CO2 discharge fitting**
- 1 – T-handle spiral cement tool with insert needle
- 1 – 10ml tube Tech Chemical Vulcanizing Fluid
- All in an easy carry pouch

*GC16 – 16g CO2 replacement cartridges available.

**PSVA – Brass CO2 discharge fitting replacement available.

No. 883 TUBELESS ON-THE-WHEEL ATV CONSUMER KIT contains:

- 10 – No. 204 Flow-Seal Inserts
- 1 – 10ml tube Vulcanizing Fluid
- 1 – No. 900 insert tool

No. 872 MOTOR KIT NO. 2 (not shown) contains:

- 8 – No. 11 tube repairs
- 2 – No. 12 tube repairs
- 2 – No. 17 tube repairs
- 1 – No. 18 tube repairs
- 1 – 20ml tube Vulcanizing Fluid
- 1 – metal buffer

PERFORMANCE TIRE KIT

No. 898 PERFORMANCE TIRE KIT. A complete kit for Uni-Seal repair of speed rated tire injuries from 1/8" (3mm) to 1/4" (6mm), with tool box, contains:

- 1 Box – No. 249UL Uni-Seal Ultras
- 1 Box – No. 250UL Uni-Seal Ultras
- 1 – No. 269 1/8" (3mm) carbide cutter
- 1 – No. 270P 1/4" (6mm) carbide cutter
- 1 – No. TRT105 Injury Measuring Tool
- 1 – No. 704A Rub-O-Matic aerosol
- 1 – No. 738 Security Coat
- 1 – No. 760 Chemical Vulcanizing Fluid
- 1 – No. S1032 Air Buffer 2,600 RPM with exhaust kit & quick chuck
- 1 – No. S1040 Quick Change Adaptor for 270 carbide cutter
- 1 – No. S1043 Quick Change Adaptor for 269 carbide cutter
- 2 – No. S1046 Quick Change Adaptor for S893 and S2027
- 1 – No. S893 1 1/2" (40mm) texture brush
- 1 – No. RH140 contour wheel
- 1 – No. 910 cement tool
- 1 – No. 911 allen wrench for quick adaptors
- 1 – No. 913 slip joint pliers
- 1 – No. 915 spiral cement tool
- 1 – No. 933 rubber scraper
- 1 – No. 936 1/8" (3mm) stitcher
- 1 Box – No. 951 white paint sticks, 12 pack
- 1 – No. S923 safety glasses
- 1 – No. TK knife
- 1 – No. RM-4 repair manual
- 1 – No. 111TM repair template

TRUCK NAIL HOLE REPAIR KIT

No. 896 TRUCK NAIL HOLE REPAIR KIT. A complete kit for road service and repairing of nail holes in both radial and bias tires, with tool box, contains:

- 1 Box – No. 170 (CT-20) radial repairs
- 1 Box – No. 166 (CT-12HD) radial repairs
- 1 Box – No. ULS8 (251-1UL) 5/16" (8mm) Uni-Seal Stems
- 1 Box – No. ULS10 (291-1UL) 3/8" (10mm) Uni-Seal Stems
- + ■ 1 – No. 271 1/4" (6mm) carbide cutter
- + ■ 1 – No. 271/38 3/8" (10mm) carbide cutter
- + ■ 1 – No. TRT105 Injury Measuring Tool
- 1 – No. 704A Rub-O-Matic aerosol
- 1 – No. 738 Security Coat
- 1 – No. 760 Chemical Vulcanizing Fluid
- 1 – No. S1032 Air Buffer 2,600 RPM with exhaust kit & quick chuck
- + ■ 1 – No. S1035 Air Drill 500 RPM with exhaust kit and quick chuck
- + ■ 1 – No. S1041 Quick Change Adaptor for 271 carbide cutter
- + ■ 1 – No. S1041/38 Quick Change Adaptor for 271/38 carbide cutter
- + ■ 2 – No. S1047 Quick Change Adaptor
- + ■ 1 – No. S892 3" (75mm) soft wire brush
- + ■ 1 – No. RH107 Rubberhog flared buffing wheel
- + ■ 1 – No. RH152 Rubberhog flared buffing wheel
- + ■ 1 – No. 911 allen wrench for quick adaptors
- + ■ 1 – No. 912 allen wrench for air tools
- + ■ 1 – No. 913 slip joint pliers
- + ■ 1 – No. 915 spiral cement tool
- + ■ 1 – No. 919 pointed awl
- + ■ 1 – No. 933 rubber scraper
- + ■ 1 – No. 936 1/8" (3mm) stitcher
- + ■ 1 – No. 940 skiving knife
- 1 Box – No. 951 white paint sticks, 12 pack
- + ■ 1 – No. S923 safety glasses
- 1 – No. 170TM repair template for 170
- 1 – No. 170TM repair template
- + ■ 1 – No. RM-5 repair manual

No. 896NHTK TRUCK NAIL HOLE (TOOLS ONLY) KIT. Contains all items marked above with a "+" and also:

- 1 – No. 896 plastic tool box
- 1 – No. CP873K low speed tire buffer with exhaust kit
- 1 – No. 939 1/4" (6mm) stitcher
- 1 – No. RM-4 repair manual
- 1 – No. ODEC5 5/2" oval decal
- 1 – No. 973 chrome vanadium diagonal pliers
- 1 – No. 270 1/4" (6mm) carbide cutter
- 1 – No. S1040 Quick Change Adaptor for 270 carbide cutter

TECH Storage Cabinets and Professional Repair Tool Station



TECH 100 LOCKING REPAIR CABINET

Cat. No.	Description
100	<p>The new Tech 100 Tire Repair Cabinet has been redesigned to better organize and secure all the Tech recommended products for proper tire repair. The cabinet features double locking front doors with Tech Tire Repair logos on the exterior, wider and taller shelves for increased repair storage capacity, and an additional exterior shelf with 4 cutouts for air tool storage.</p> <p>TOOLS AND REPAIR MATERIALS SOLD SEPARATELY.</p> <p>Dimensions: 30" x 24" x 11.5" (760mm x 610mm x 295mm) Weight: 27.5lbs. (12.45kg)</p> <p>Inner Door Labeled Tool Bars store:</p> <ul style="list-style-type: none"> ■ No. TRT105 Measuring Tool ■ No. 933 Rubber Scraper ■ No. RH140 Buffing Wheel ■ No. 269, 270 & 271 Carbide Cutters ■ No. S893 Wire Brush ■ No. 910 Fluted Cement Tool ■ No. 915 Spiral Cement Tool ■ No. 913 Pliers ■ No. 973 Diagonal Side Cutting Pliers ■ No. 938 Stitcher



TECH 500 PROFESSIONAL REPAIR TOOL STATION

Cat. No.	Description
500	<p>Tech's 500 Repair Station is recommended for any full service repair facility. This tool organizer neatly stores all the recommended knives, buffing rasps and wheels, texture brushes, encapsulated brushes, carbide burrs, and aluminum oxide stones for the full range of radial and bias tire repairs. Repair templates or chemicals can be stored inside. The box now comes assembled with optional air tool hanging bracket and mounting hardware included.</p> <p>TOOLS AND REPAIR MATERIALS SOLD SEPARATELY.</p> <p>Dimensions: 15" x 12" x 12" Weight: 10.5lbs., 4.8kg</p>



AIR TOOLS & RETREAD TOOLS

Cat. No.	Description
S999	<p>QUICK SPIFF AIR POWERED VACUUM Self contained one piece vacuum comes with 16", 400mm hose, 3", 75mm dust brush and 9", 225mm crevice tool.</p>
410SV	SAFETY BLOW GUN, 150 psi max. pressure

TECH

Hand Tools for Tire Repair

Tech tools and accessories are made of the highest quality materials and are designed to make your tire repair job easier and faster.

STITCHERS AND SCRAPERS



Cat. No.	Description
933	RUBBER SCRAPER
935	STITCHER/BUFFER
936	STITCHER, 1½", 38mm x 1/8", 3mm
938	STITCHER, 1½", 38mm x 1/32", 0.8mm
939	STITCHER, 2", 50mm x 1/4", 6mm

INSERT TOOLS



Cat. No.	Description
900	INSERT TOOL, 3", 75mm
901	INSERT TOOL, 6", 150mm
905	HEAVY DUTY INSERT TOOL, 9", 225mm
920	INSERT-O-MATIC TOOL
921	PASSENGER REPLACEMENT NEEDLE
923	INSERT-O-MATIC TRUCK NEEDLE

MISCELLANEOUS TIRE REPAIR TOOLS



Cat. No.	Description
913	SLIP JOINT PLIERS, 8", 200mm
973	DIAGONAL PLIERS, 6", 150mm
931	WIRE BUFFER for rim/battery terminal
949	CRAYON HOLDER, designed to fit Tech's hex tire paint marking crayons
966	WHITEWALL CLEANING BRUSH with brass bristles
974	INNERLINER BRUSH with stainless steel bristles
SIP	SILVER INK PEN, 12 per box
TRT105	COLOR CODED INJURY MEASURING TOOL

AWLS AND PACKING TOOLS



Cat. No.	Description
910	3" CEMENT TOOL with polypropylene handle
915	SPIRAL CEMENT TOOL
918	DUCK BILL AWL, 4", 100mm length
919	POINTED AWL, 8", 200mm length (screwdriver-style handle)
985	SKIVE PACKING TOOL, 2", 50mm x 1/4", 6mm
986	SKIVE PACKING TOOL, 2", 50mm x 3/8", 10mm

TECH Knives, Extruder Guns & Branding Irons

Tech tools and accessories are made of the highest quality materials and are designed to make your tire repair job easier and faster. Tech also offers a complete line of air buffers and accessories.

Tech Extruder Guns are designed to fill a wide range of injuries quickly and easily without trapping air. Perfect for section repair build-up and for filling skives. Extruder Guns are compact, lightweight and user friendly. Available in 110V or 220V.

Tech Electric Knife Heater is ideal to heat rubber cutting knives, shears and small tools that require heat for efficient operation. The accompanying Heater Knife comes with an 8", 200mm blade for fast, easy trimming and cutting of rubber.

The Tire Brander allows retreaders and tire technicians to quickly and easily brand tires for proper identification. 1/2", 13mm characters (letters and numbers) and 1/4", 6mm characters are available for use with the brander.

SKIVING KNIVES & SCISSORS



Cat. No.	Description	Pkg. Qty.
940	X2T TAPER SKIVING KNIFE	1
941	X1Y EXTRA CURVE SKIVING KNIFE	1
942	X3N ROUND POINT FLEXIBLE SKIVING KNIFE	1
SS10	HEAVY DUTY RETREAD SCISSORS 5", 125mm cut	1

BUTYL RETREAD ENVELOPE REPAIR SYSTEM (ERS)



Cat. No.	Description
672	ERS-45 ENVELOPE REPAIR UNITS 1 3/4", 45mm diameter, 50 ct. tub
772	ENVELOPE VULCANIZING FLUID, 8 oz., 235ml can

TECH EXTRUDER GUNS



Cat. No.	Description
S180*	NAIL HOLE REPAIR EXTRUDER GUN, 110V
S182*	STANDARD EXTRUDER GUN, 110V

*Available in 220V as special order only.
Parts/Service and Loaner programs available.

RETREAD TOOLS & ACCESSORIES

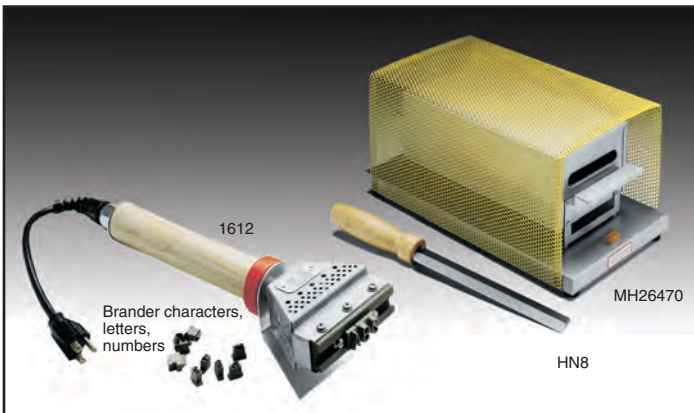

Cat. No.	Description
MH26470	ELECTRIC KNIFE HEATER, 115V, 350 watt rated, max. temperature 820°F, 437°C
HN8	INSULATED HEATER KNIFE, 8", 200mm blade
1612	TIRE BRANDER, 120V. (To order characters, letters and numbers, see information below)

Characters (letters and numbers) for the Brander can be ordered by using the following examples:

You order: 1612A You order: 16148
16 = Number for Brander 16 = Number for Brander
12 = 1/2" letters or numbers 14 = 1/4" letters or numbers
A = 1/2" letter A 8 = 1/4" number 8

You order: 1614A
16 = Number for Brander
14 = 1/4" letters or numbers
A = 1/4" letter A



Tire Inspection Marking Tools

At Tech, we partner with manufacturers who have as much pride and quality in their product as we do. Tech is proud to offer high-quality, high-performance Markal products to our customers at the very highest level of service.

For over 75 years, Markal has designed and manufactured high-quality, performance based products for their, and our, customers' unique applications.

Markal brand is the global leader in high-performance, hand-held industrial marking products. From their manufacturing locations in Elk Grove Village, IL, USA and Blyes, France, Markal produces and sells high-performance industrial markers for many industries, including tire and wheel repair.

Today, Markal-branded products are sold around the world in over 60 countries.

Trades-Marker[®] Mechanical Marker Pencil



TRADES-MARKER[®] Mechanical Marker Pencil has the marking versatility of a paper-wrapped grease pencil combined with simple, one-handed push-button advance that helps reduce cost and waste. This refillable, all-surface marker leaves a wear-resistant mark and is safe for all surfaces. Convenient clip allows for pocket storage and prevents rolling off work table.

TRADES-MARKER[®] MECHANICAL MARKER PENCIL

Cat. No.	Description	Qty.
946W	TRADES-MARKER [®] WHITE Mechanical Marker Pencil with 12 refills	Ea.
946Y	TRADES-MARKER [®] YELLOW Mechanical Marker Pencil with 12 refills	Ea.

Quik Stik[®] Mini Twist Paint Marker



The **Markal Quik Stik[®] Mini Twist Paint Marker** is a compact solid paint marker in a convenient twist-up, plastic holder that is ideal for finer line marking on smooth or rough surfaces. This smaller version of the Markal[®] Quik Stik stores easily in a pocket or tool belt and easily advances with the turn of a knob, allowing for full use of the marker. The high-performance paint dries quickly to leave bold, permanent marks on most surfaces.

MARKAL QUIK STIK[®] MINI TWIST PAINT MARKER

Cat. No.	Description	Box Qty.
947W	QUIK STIK [®] WHITE Mini Twist Paint Marker	12
947Y	QUIK STIK [®] YELLOW Mini Twist Paint Marker	12



Tire Inspection Marking Tools

B Paintstik[®] Solid Paint Marker

Markal's most versatile and economic marker, the original **B Paintstik Solid Paint Marker** combines the durability of paint in the convenience of a crayon. The real paint formula has superior marking performance on oily, icy, wet, dry or cold surfaces and is weather- and UV-resistant. This Paintstik works on rough, rusty, smooth, or dirty surfaces.



B PAINTSTIK[®] SOLID PAINT MARKER

Cat. No.	Description	Box Qty.
948	B PAINTSTIK [®] WHITE Solid Paint Marker	12
948Y	B PAINTSTIK [®] YELLOW Solid Paint Marker	12
951	B PAINTSTIK [®] HEX WHITE Solid Paint Marker	12
951Y	B PAINTSTIK [®] HEX YELLOW Solid Paint Marker	12

TYRE MARQUE[®]

Cat. No.	Description	Box Qty.
950	TYRE MARQUE [®] YELLOW Solid Paint Crayon, marks easily on wet or cold rubber surfaces for bold, visible marks	12
950W	TYRE MARQUE [®] WHITE Solid Paint Crayon, marks easily on wet or cold rubber surfaces for bold, visible marks	12

CHINA MARKER

Cat. No.	Description	Box Qty.
96010	CHINA MARKER WHITE, paper wrapped grease pencil for smooth writing on most surfaces. Moisture resistant. No sharpening required.	12

Markal[®] Anti-Seize Compound

EZ BREAK[®] ANTI-SEIZE COMPOUND – COPPER GRADE This copper-based anti-seize and lubricating compound is recommended for coating nuts, bolts, valves, flanges, and splines for easy break out after years of service. Resists rust and corrosion. Meets Military Specification Mil-A-907E. Authorized by USDA for use in federally inspected meat and poultry plants.



EZ BREAK[®] ANTI-SEIZE COMPOUND – COPPER GRADE

Cat. No.	Description	Case Qty.
418-08907	EZ BREAK [®] ANTI-SEIZE COMPOUND 16 oz. Brush in Cap	24
418-08910	EZ BREAK [®] ANTI-SEIZE COMPOUND 10 oz. Brush in Cap	24

TECH

Worker Safety & Protection Items



REPAIR LIGHT & EYE PROTECTION

Cat. No.	Description
S1055N	FLUORESCENT REPAIR LIGHT 110V only, 25 ft., 7.5m power cord
S918	SAFETY GLASSES, fit over most prescription eyeglasses
S920	SAFETY GOGGLES, side top and breathing vents
S923	SAFETY GLASSES, clear lenses with padded spatula temples for comfort. Meets ANSI standards.
S924	SAFETY GLASSES, gray shaded lenses with padded spatula temples for comfort. Meets ANSI standards.
S925	CHEMICAL SPLASH & CUTTING GOGGLES, with blue translucent flexible frames & clear anti-fog lens
S1056	REPLACEMENT FLUORESCENT BULB for S1055N



LATEX, NITRILE AND STRONGHOLD GLOVES

Cat. No.	Description	Box Qty.
EP2244	DURA-GRIP LATEX GLOVES, LG, 8 mil	100
EP2245	DURA-GRIP LATEX GLOVES, XL, 8 mil	100
EP5644	NITRILE GLOVES, LG, 4 mil	100
EP5645	NITRILE GLOVES, XL, 4 mil	100
EP6644	NITRILE PLUS GLOVES, LG, 8 mil	50
EP6645	NITRILE PLUS GLOVES, XL, 8 mil	50
EP8544	STRONGHOLD GLOVES, LG, pair	1
EP8545	STRONGHOLD GLOVES, XL, pair	1
EP10044	BLACK GOLD NITRILE GLOVES, LG, 6 mil	100
EP10045	BLACK GOLD NITRILE GLOVES, XL, 6 mil	100

TECH

Cleaning Products



HAND CLEANERS

Cat. No.	Description
730	TECH MEDICATED HAND CLEANER, 4.5 lb., 2.05kg can
730C	TECH CITRUS MEDICATED HAND CLEANER, 4.5 lb., 2.05kg can
731	DISPENSER for 730 and 732 Hand Cleaner cans
732	TECH PUMICE HAND CLEANER, 4.5 lb., 2.05kg can
732C	TECH CITRUS PUMICE HAND CLEANER, 4.5 lb., 2.05kg can
743	TECH SOY HAND CLEANER, 72 oz., 2125ml
743SP	TECH SOY HAND CLEANER STARTER KIT, Dispenser Pump and 72 oz., 2125ml Soap

TECH

Air Tools & Accessories



DRILLS, BUFFERS & AIR HAMMERS

Cat. No.	Description
CP871	HIGH SPEED TIRE BUFFER
*CP871K	HIGH SPEED TIRE BUFFER with exhaust kit
CP873	LOW SPEED TIRE BUFFER
CP873K	LOW SPEED TIRE BUFFER with exhaust kit
CP9288	12" HEAVY DUTY PISTOL DRILL, .5 hp (380W) motor, high torque, keyless chuck
S1035	500 RPM REVERSIBLE DRILL excellent for removing damaged rubber and steel. Complete with quick change chuck and exhaust kit. For use with carbide cutters 269-272, max. 90 psi.
S1036	LOW RPM GEAR HEAD REAR EXHAUST AIR BUFFER Ideal for preparing all rubber surfaces. 4000 max. rpm at 90 psi. Threaded arbor 3/8", 24 thread. Optional S1037 rear exhaust kit available. Chuck and key sold separately.
S1037	REAR EXHAUST KIT for use with S1032, S1035, S1036, S1039 and SLP6550
S1039	HIGH RPM REAR EXHAUST AIR BUFFER Excellent for preparing steel cables. 22000 max. rpm at 90 psi. Threaded arbor 3/8", 24 thread. Optional S1037 rear exhaust kit available. Chuck and key sold separately.
S1010C	JACOBS CHUCK for S1036 and S1039
S1010K	CHUCK KEY for S1036 and S1039
S1045	QUICK CHANGE CHUCK for S1036 and S1039. Fits 3/8", 24 thread spindle.
SLP6550	3500 RPM HIGH TORQUE SKIVING AIR BUFFER Threaded arbor 3/8" with quick chuck. Made in U.S.A.



ADAPTORS, CHUCKS & ACCESSORIES

Cat. No.	Description
S1040	QUICK CHANGE ADAPTOR for No. 270 and No. 270P carbide cutters. For use in S1045 quick change chuck.
S1041	QUICK CHANGE ADAPTOR for No. 271 and No. 271P carbide cutters. For use in S1045 quick change chuck.
S1041/38	QUICK CHANGE ADAPTOR designed to accept a No. 271/38 and No. 272 carbide cutter. (not shown) Use 912 Allen Wrench for tightening. (not shown)
S1043	1/8" QUICK CHANGE ADAPTOR permits use of tools with 1/8", 3mm shank to be adapted to S1045 chuck.
S1044	1/4" QUICK CHANGE ADAPTOR permits use of tools with 1/4", 6mm shank to be adapted to S1045 chuck.
S1046	QUICK CHANGE SHORT ADAPTOR 3/8", 24 thread. One flat washer, one nut included. 1/2", 13mm thread length.
S1046D	QUICK CHANGE ADAPTOR for RSB-3 brush. (not shown)
S1047	QUICK CHANGE LONG ADAPTOR 3/8", 24 thread. One flat washer, one nut included. 1", 25mm thread length.
S1047XL	QUICK CHANGE EXTRA LONG ADAPTOR 3/8", 24 thread. One flat washer, two nuts included. 1 3/4", 45mm thread length. For rasps, buffing wheels & brushes where extra length is required.
S1048	DRILL CHUCK SHORT ADAPTOR 3/8", 24 thread. 1 1/2", 40mm thread length. For use with S1010 drill chuck.
S1049	DRILL CHUCK LONG ADAPTOR 3/8", 24 thread. 2 3/4", 70mm thread length. Two nuts included. For use with S1010 drill chuck.



AIR TOOLS & ACCESSORIES

Cat. No.	Description
S990	RAPID ACTION AIR HAMMER recommended tool for agricultural, truck and OTR repair installation. Develops 3,700 strikes per minute at 90 psi. Comes with safety chuck holder.
S991	REPLACEMENT SAFETY CHUCK HOLDER
S992	REPAIR INSTALLATION HAMMER 1/2", 15mm diameter
S1032	LOW RPM GEAR HEAD REAR EXHAUST AIR BUFFER Ideal for preparing all rubber surfaces. Three gear head produces 2600 max. rpm at 90 psi. Complete with exhaust hose and quick change chuck.
*FP-708	HIGH RPM, REAR EXHAUST AIR BUFFER Excellent for preparing steel cables. 20,000 max. rpm at 90 psi. Complete with Jacobs chuck exhaust kit.
*FP-755	LOW RPM, GEAR HEAD REAR EXHAUST AIR BUFFER ideal for preparing all rubber surfaces. 4500 max. rpm at 90 psi. Threaded arbor 3/8", 24 thread. Optional S1037 rear exhaust kit available.

*DENOTES SPECIAL ORDER ITEM

TECH Carbide Cutters, Carbide Burrs & Grinding Stones for Steel Cables

Tech diamond-cut Carbide Cutters and Burrs are innovative skiving tools. They are used to remove damaged steel cables and loose wire in radial tires and are a quick and efficient way to minimize the size of the injury.

Sherbo buffing stones for steel constructed tires are used to remove all loose steel wire around a tire injury. Stones are aluminum oxide hardbound 60-grit, mounted on steel shafts.

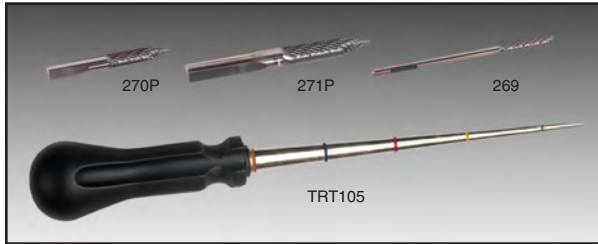

CAUTION: Always wear eye protection.

SMALL CARBIDE CUTTERS FOR SMALL PASSENGER AND LIGHT TRUCK TIRES ONLY

Cat. No.	Description
*269	CARBIDE CUTTER, 3", 75mm length, for 1/8", 3mm injuries
*270P	CARBIDE CUTTER, 2", 50mm length, for 1/4", 6mm injuries
*271P	CARBIDE CUTTER, 3", 75mm length, for 5/16", 8mm injuries
TRT105	COLOR CODED INJURY MEASURING TOOL

*1200 RPM maximum

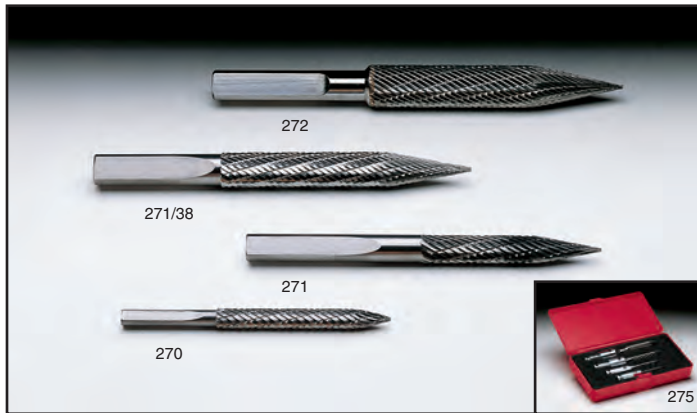

CAUTION: Always wear eye protection.

CARBIDE CUTTERS

Cat. No.	Description
*270	CARBIDE CUTTER, 3", 75mm length, for 1/4", 6mm injuries
*271	CARBIDE CUTTER, 4", 100mm length, for 5/16", 8mm injuries
*271/38	CARBIDE CUTTER, 4" 9/16", 120mm length, for 3/8", 10mm injuries
*272	CARBIDE CUTTER, 5", 125mm length, for 1/2", 13mm injuries

*1200 RPM maximum

CARBIDE CUTTER KIT

No. 275 CARBIDE CUTTER KIT contains:

- 1 – No. 270 Carbide Cutter with S1040 Adaptor. Cutter diameter 1/4", 6mm
 - 1 – No. 271 Carbide Cutter with S1041 Adaptor. Cutter diameter 5/16", 8mm
 - 1 – No. 271/38 Carbide Cutter with S1041/38 Adaptor. Cutter diameter 3/8", 10mm
 - 1 – No. 272 Carbide Cutter with S1041/38 Adaptor. Cutter diameter 1/2", 13mm
- Above adaptors to be used with S1045 Quick Change Chuck

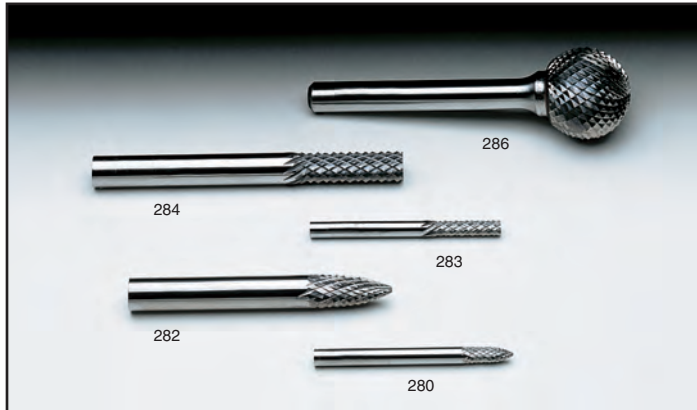

CAUTION: Always wear eye protection.

DIAMOND-CUT BURRS

Cat. No.	Description	Shaft Size
280	MINI POINTED CARBIDE BURR 1 1/4", 30mm length	1/8", 3mm
282	POINTED END CARBIDE BURR 2", 50mm length	1/4", 6mm
283	MINI-ROUTER CARBIDE BURR 1 1/2", 40mm length	1/8", 3mm
284	ROUTER CARBIDE BURR, 2 1/2", 65mm length	1/4", 6mm
284C	COARSE-CUT ROUTER CARBIDE BURR 2 1/2", 65mm length (not shown)	1/4", 6mm
286	BALL-SHAPED CARBIDE BURR 2 3/4", 70mm length, 3/4", 20mm diameter	1/4", 6mm

NOTE: When using Cat. Nos. 280, 282, 283, 274C and 286, a buffer achieving 20,000 to 30,000 RPM will produce the best results.

ALUMINUM OXIDE STONES

Cat. No.	Description	Max. RPM
S870	MINI-PENCIL STONE, 7/16", 10.5mm, mounted on a 1/8", 3mm shaft	30,000
S872	PENCIL STONE, 1 1/16", 25mm long 5/16", 8mm width	47,000
S872S	SMALL PENCIL STONE, 1 1/16", 25mm long 1/4", 6mm width (not shown)	47,000
S873	MUSHROOM STONE, 1 5/8", 40mm diameter, mounted on a 1/4", 6mm shaft	23,500
S874	MINI MUSHROOM STONE, 1/2", 13mm x 1/4", 6mm mounted on a 1/8", 3mm shaft	30,000
S875	CONICAL STONE, 1 1/8", 20mm x 3/4", 20mm wide mounted on a 1/4", 6mm shaft	33,500
S879	MUSHROOM STONE, 1 1/4", 30mm diameter, mounted on a 1/4", 6mm shaft	30,500



CAUTION: Always wear eye protection.

RUBBERHOG® Tire Repair Tools

RubberHog wheels and rasps feature SSG coatings which provide a uniform surface texture for maximum adhesion. Flared Contour Wheels are designed so that the technician can keep a large area of the tool in contact with the tire, resulting in a more even buffed surface. 5,000 RPM maximum.

- **Unique Profile**
Flared Contour Wheels properly match the shape of the tire.
- Provides wide, level contact with surface.
- Efficient use of the entire tool.
- Easier to use - less operator fatigue.
- Reduced buffing time.

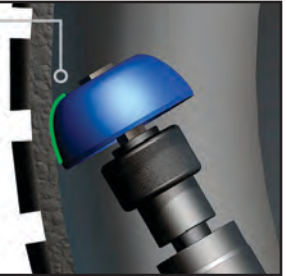



CAUTION: Always wear eye protection.

FLARED CONTOUR WHEELS

Proven RubberHog widely-flared shapes are versatile for both interior and exterior buffing. Flared contour wheels remove material quickly while providing a superior bonding surface, or exterior cosmetics.

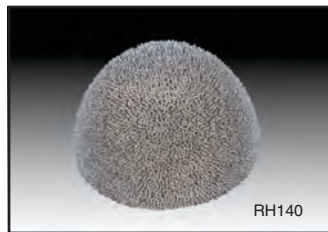
Cat. No.	Mfg. No.	Diameter	Width	Bore	Coating
RH100	100	1 3/4", 44.4mm	3/4", 19mm	3/8", 9.5mm	170 - Fine
RH102	130-170	2", 50.8mm	3/4", 19mm	3/8", 9.5mm	170 - Fine
RH104	130-230	2", 50.8mm	3/4", 19mm	3/8", 9.5mm	230 - Medium
RH107	107	2 1/2", 63.1mm	1 1/16", 26.9mm	3/8", 9.5mm	170 - Fine
RH109	109	2 1/2", 63.1mm	1 1/16", 26.9mm	3/8", 9.5mm	230 - Medium
RH111	111	2 1/2", 63.1mm	1 1/16", 26.9mm	3/8", 9.5mm	390 - Coarse
RH112	112	3", 76.2mm	1 1/4", 31.7mm	3/8", 9.5mm	170 - Fine
*OLVRH114	114	3", 76.2mm	1 1/4", 31.7mm	3/8", 9.5mm	230 - Medium
*OLVRH116	116	3", 76.2mm	1 1/4", 31.7mm	3/8", 9.5mm	390 - Coarse
RH118-3/8	118	3 1/2", 88.9mm	1 1/2", 38.1mm	3/8", 9.5mm	170 - Fine
RH120	120	3 1/2", 88.9mm	1 1/2", 38.1mm	3/8", 9.5mm	230 - Medium
RH122	122	3 1/2", 88.9mm	1 1/2", 38.1mm	3/8", 9.5mm	390 - Coarse
*RH129P	129	4", 101.6mm	1 1/2", 38.1mm	3/4", 19mm	390 - Coarse



CAUTION: Always wear eye protection.

LOW-PROFILE BUFFING WHEEL

Unique design allows buffing in low profile tires without risking sidewall damage.

Cat. No.	Mfg. No.	Diameter	Width	Bore	Coating
RH140	140	1 1/4", 31.7mm	3/4", 19mm	3/8"- 24 Thread	170 - Fine

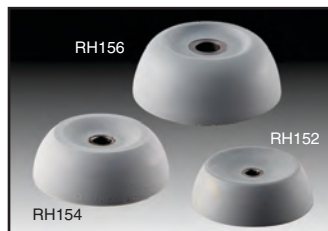

CAUTION: Always wear eye protection.

POLY PLUGS FOR FLARED CONTOUR WHEELS

Poly Plugs easily fit inside Contour Wheels, compensating for mounting inaccuracies. Reusable Poly Plugs improve wheel life and reduce vibration for smoother, quieter, more comfortable operation.

Cat. No.	Mfg. No.	Diameter	Bore
RH152	152	2 1/2", 63.1mm	3/8", 9.5mm
RH154	154	3", 76.2mm	3/8", 9.5mm
RH156	156	3 1/2", 88.9mm	3/8", 9.5mm

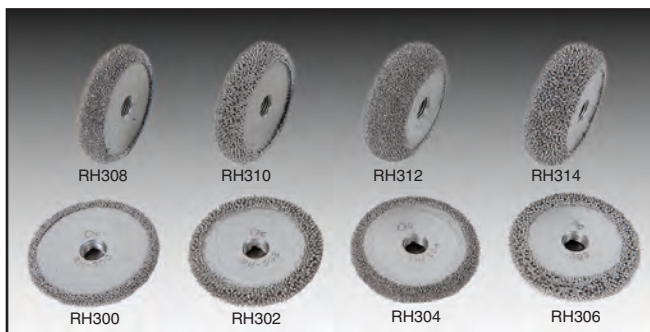

CAUTION: Always wear eye protection.

BUZZOUT WHEELS

With a fully-rounded profile, buzzout wheels are free cutting and long lasting. Buzzout wheels are excellent for bias tires, and used for skiving on high-tread radial tires. Not recommended for contact with steel cord.

Cat. No.	Mfg. No.	Diameter	Width	Bore	Coating
RH300	300	2", 51.8mm	1/4", 6.3mm	3/8"- 24 Thread	230 - Medium
RH302	302	2", 51.8mm	1/4", 6.3mm	3/8"- 24 Thread	390 - Coarse
RH304	304	2", 51.8mm	3/8", 9.5mm	3/8"- 24 Thread	230 - Medium
RH306	306	2", 51.8mm	3/8", 9.5mm	3/8"- 24 Thread	390 - Coarse
RH308	308	2", 51.8mm	1/2", 12.7mm	3/8"- 24 Thread	230 - Medium
RH310	310	2", 51.8mm	1/2", 12.7mm	3/8"- 24 Thread	390 - Coarse
RH312	312	2", 51.8mm	3/4", 19mm	3/8"- 24 Thread	230 - Medium
RH314	314	2", 51.8mm	3/4", 19mm	3/8"- 24 Thread	390 - Coarse

*DENOTES SPECIAL ORDER ITEM

RUBBERHOG® Tire Repair Tools

Rubberhog features innovations from the leader in the industry. The Rubberhog Original SSG coating uses the best technology to ensure peace of mind.

- Buffs cooler, no scorching
- Fantastic wear life, costing you less per repair
- Better surface texture for a safer bond
- Faster material removal, for a quicker repair

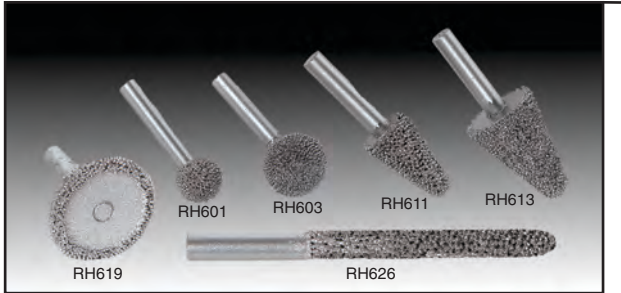
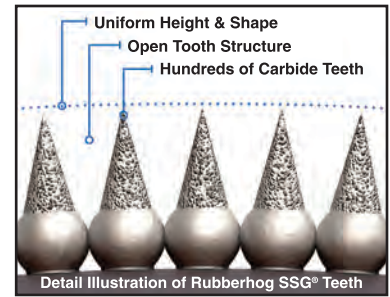

CAUTION: Always wear eye protection.

TAPERED CONES, BALLS, PENCIL RASP, ROTOR SAW, 1/4" SHAFT

Cat. No.	Mfg. No.	Shape	Diameter	Head Length	Coating
RH601	601	Sphere	5/8", 15.8mm	5/8", 15.8mm	330 - Coarse
RH603	603	Sphere	7/8", 22.2mm	7/8", 22.2mm	330 - Coarse
RH605	605	Sphere	1 1/8", 28.5mm	1 1/8", 28.5mm	330 - Coarse
RH611	611	Taper	5/8", 15.8mm	1", 25.4mm	330 - Coarse
RH613	613	Taper	7/8", 22.2mm	1 1/4", 31.7mm	330 - Coarse
RH619	619	Rotor Saw	1 3/8", 34.9mm	1/4", 6.3mm	330 - Coarse
RH626	626	Nail Hole Reamer	1/4", 6.3mm	3", 76.2mm	330 - Coarse

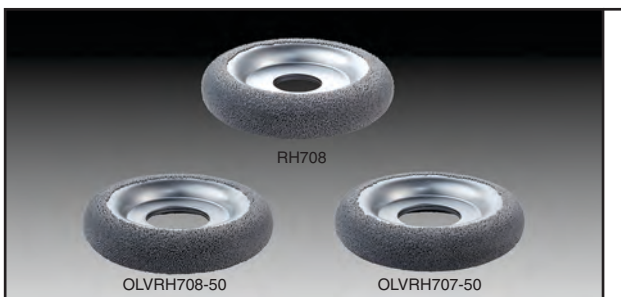

CAUTION: Always wear eye protection.

RETREADING SIDEWALL WHEELS

Cat. No.	Mfg. No.	Shape	Diameter	Width	I.D.	Coating
*OLVRH707-50	707-50	Donut Wheel	6", 152.4mm	1", 25.4mm	50mm	460 - Med. Coarse
RH708	708	Donut Wheel	6", 152.4mm	1", 25.4mm	1 1/2", 38.1mm	390 - Coarse
*OLVRH708-50	708-50	Donut Wheel	6", 152.4mm	1", 25.4mm	50mm	390 - Coarse



CAUTION: Always wear eye protection.

KUTZALL KIT, CAT. NO. RH635, 4-PIECE 1/8" SHAFT REPAIR KIT contains:

Cat. No.	Mfg. No.	Shape	Diameter	Head Length	Coating
RH635	635	Long Taper	1/8", 3.1mm	3/4", 19mm	170 - Fine
		Short Taper	1/4", 6.3mm	1/2", 12.7mm	170 - Fine
		Sphere	3/8", 9.5mm	3/8", 9.5mm	170 - Fine
		Rotor Saw	3/4", 19mm	1/8", 3.1mm	170 - Fine

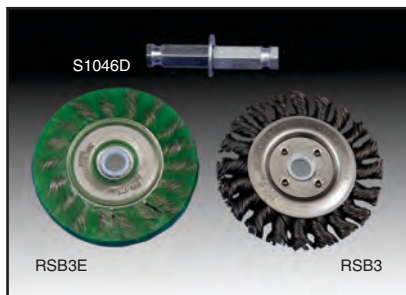

CAUTION: Always wear eye protection.

RADIAL SKIVE BRUSHES

Cat. No.	Description
RSB3	RADIAL SKIVE BRUSH, 3", 75mm diameter, fits 1/2", 13mm or 3/8", 10mm arbors
RSB3E	PLASTIC ENCAPSULATED BRUSH, same as RSB3
S1046D	DUAL QUICK CHANGE ADAPTOR, 3/8", 10mm diameter

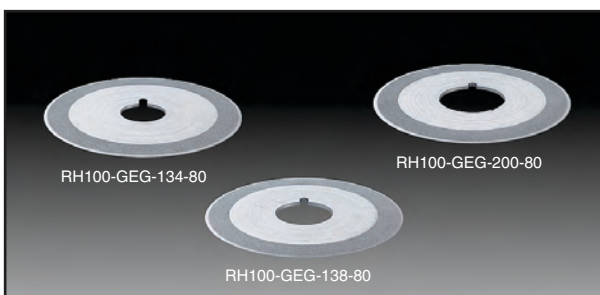

CAUTION: Always wear eye protection.

ROTARY KNIFE BLADES

Cat. No.	Mfg. No.	Shape	Diameter	Bore	Coating
*RH100-GEG-134-80	100-GEG-134-80	Rotary Knife	6", 152.4mm	1 3/4", 44.4mm	80 Grit
*RH100-GEG-138-80	100-GEG-138-80	Rotary Knife	6", 152.4mm	1 3/8", 34.9mm	80 Grit
*RH100-GEG-200-80	100-GEG-200-80	Rotary Knife	6", 152.4mm	2", 50.8mm	80 Grit

*DENOTES SPECIAL ORDER ITEM

TECH

Buffing Wheels, Tungsten Carbide Rasps & Cups

Sherbo tungsten carbide buffing wheels and cups have an air-cooled design which permits faster, cooler and cleaner buffing and helps eliminate the burning of rubber.



CAUTION: Always wear eye protection.

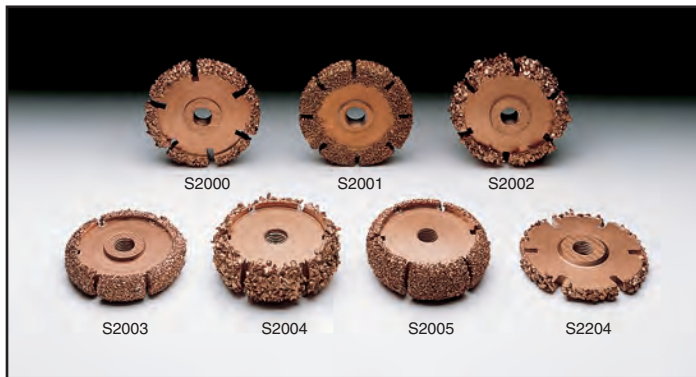

CAUTION: Always wear eye protection.



CAUTION: Always wear eye protection.

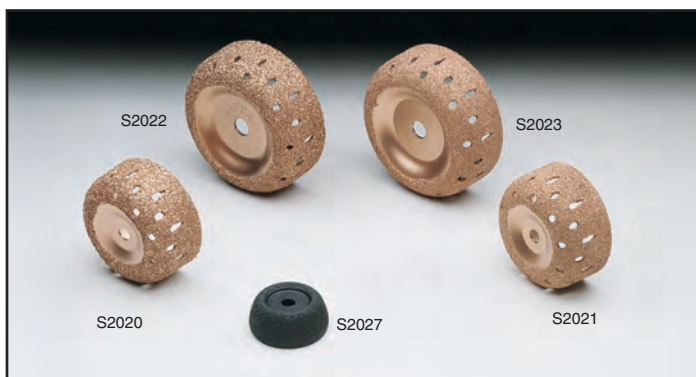

CAUTION: Always wear eye protection.

WHEELS

Cat. No.	Description
S1009	BC-2 WHEEL, a 2", 50mm diameter wheel for tube repairs and light work. 5000 RPM max.
S1011	BC-1 WHEEL, a 2½", 65mm diameter wheel for tube repairs and light work. 5000 RPM max.
S1011-1	TWO BC-1 WHEELS (S1011) placed back-to-back with S1049 threaded arbor adaptor. 5000 RPM max.
S2032	NO. 60 HB NICKEL CHROMIUM BUFFING WHEEL designed to outlast copper colored wheels. For texturizing of tubes and innerliners. 2½", 65mm diameter, ⅜", 10mm arbor hole. 5000 RPM max.

ROUND FACED RASPS

Cat. No.	Ø or Length	Width	Hole	Grit
S2000	2", 50mm	¼", 6mm	⅜", 24 thread	16
S2001	2", 50mm	¼", 6mm	⅜", 24 thread	36
S2002	2", 50mm	½", 13mm	⅜", 24 thread	16
S2003	2", 50mm	½", 13mm	⅜", 24 thread	36
S2004	2", 50mm	¾", 20mm	⅜", 24 thread	16
S2005	2", 50mm	¾", 20mm	⅜", 24 thread	36
S2204	2", 50mm	1/8", 3mm	⅜", 24 thread	16

The maximum speed for items S2000 through S2204 is 5000 RPM.

PENCIL RASPS, TAPERED CONE RASPS

Cat. No.	Ø or Length	Width	Hole	Grit
S2006	2½", 65mm	¼", 6mm	–	16
S2007	2½", 65mm	¼", 6mm	–	36
S2008	4", 100mm	¾", 20mm	⅜", 24 thread	16
S2009	4", 100mm	¾", 20mm	⅜", 24 thread	36
S2010	2", 50mm	1", 25mm	⅜", 24 thread	16
S2011	2", 50mm	1", 25mm	⅜", 24 thread	36

The maximum speed for items S2006 through S2011 is 5000 RPM.

CONTOUR CUPS

Cat. No.	Ø or Length	Width	Hole	Grit
S2020	3", 75mm	1½", 40mm	⅜", 10mm	36
S2021	3", 75mm	1½", 40mm	⅜", 10mm	60
S2022	4", 100mm	1½", 40mm	½", 13 mm	36
S2023	4", 100mm	1½", 40mm	½", 13 mm	60
S2027	2", 50mm	¾", 20mm	⅜", 10mm	60

The maximum speed for items S2020 through S2027 is 5000 RPM.

The use of an S2047 (page 41) is necessary when using S2022 and S2023 with quick change adaptors.

S2027 designed with non-aggressive grit for passenger tire inner liner and tube buffing.

TECH Wire Brushes

Tech's encapsulated wire brushes are a critical component to performing section repairs. These brushes can be used to remove rubber surrounding steel cables, allowing damaged steel to be removed without creating excess scorch.

Tech's S892 cleaning brush includes two 3", 75mm soft brushes to be configured between two 2", 50mm flat washers (also included), providing a durable and effective tool for cleaning buffed surfaces while leaving an excellent texture.

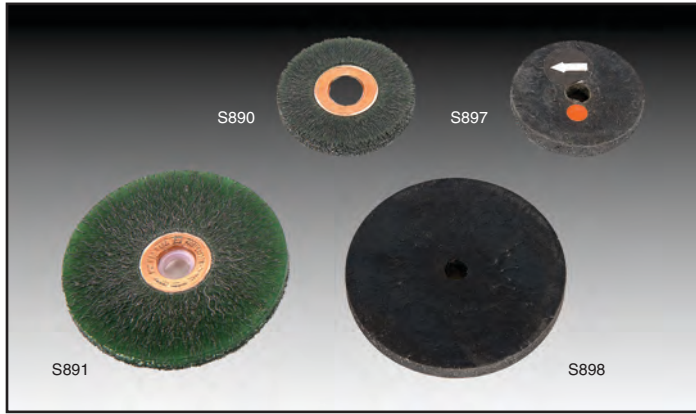

ENCAPSULATED WIRE BRUSHES

Cat. No.	Description
S890	POLYURETHANE ENCAPSULATED BRUSH to remove rubber around steel cables. 2", 50mm diameter, 5,000 rpm max. 1/2", 13mm arbor hole with 3/8", 10mm reducer.
S891	POLYURETHANE ENCAPSULATED BRUSH to remove rubber around steel cables. 3", 75mm diameter, 5,000 rpm max. 1/2", 13mm arbor hole with 3/8", 10mm reducer.
S897	RUBBER ENCAPSULATED BRUSH to remove rubber around steel cables. 2", 50mm diameter, 5,000 rpm max. 1/2", 13mm arbor hole with 3/8", 10mm reducer.
S898	RUBBER ENCAPSULATED BRUSH to remove rubber around steel cables. 3", 75mm diameter, 5,000 rpm max. 1/2", 13mm arbor hole with 3/8", 10mm reducer.



WIRE BRUSHES

Cat. No.	Description
S892	TEXTURE BRUSH, contains (2) 3", 75mm brushes and (2) 2", 50mm flat washers to keep bristles firm. 5,000 rpm max.
S893	SOFT WIRE TEXTURE BRUSH, 1 1/2", 40mm diameter. Ideal for cleaning buffed surfaces in passenger tire nailhole repairs and feathering loose inner liners. 5,000 rpm max.
S894	RIM CLEANING BRUSH, 2", 50mm. 5,000 rpm max.
S896	SKIVE BRUSH removes scorched rubber in injury channel. 1/2", 13mm, .005 wire. 5,000 rpm max.

TECH Buffing Stones

Buffing stones are recommended for buffing the inside of bias tube type tires with very little rubber covering body cord material. These stones produce the desired texture without damaging exposed fabric.

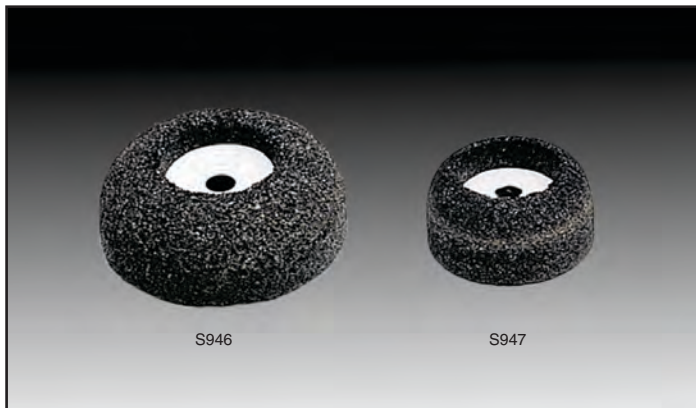

BUFFING STONES

Cat. No.	Description
S946	BUFFING STONE, 4" x 1 1/4", 100mm x 30mm, 46 grit, 1/2", 13mm arbor hole, 4,200 rpm max.
S947	BUFFING STONE, 3" x 1 1/4", 75mm x 30mm, 46 grit, 3/8", 10mm arbor hole, 5,000 rpm max.

CAUTION: Always wear eye protection.

B&J Rotary Gouges

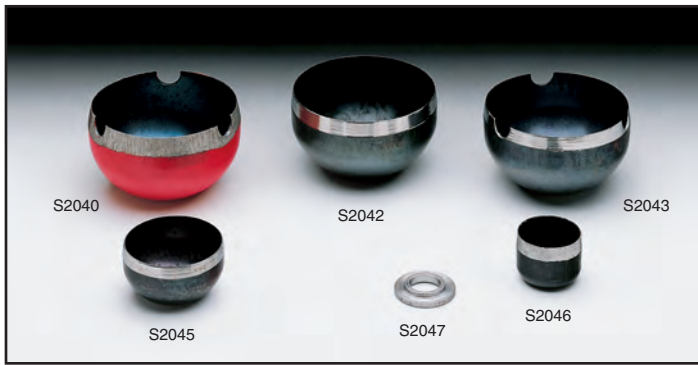

CAUTION: Always wear eye protection.

Lightweight construction and cooler running design enhances the performance and life of these B&J rubber cutting gouges. The razor-like surface quickly removes large quantities of rubber. Fast and easy rubber removal design minimizes operator fatigue and permits better control.

GOUGES

Cat. No.	Description
S2040	ROTARY GOUGE, 2", 50mm diameter, 1/2", 15mm arbor hole. 1 per box
S2042	THIN WALL ROTARY GOUGE, 2", 50mm diameter, 3/8", 10mm arbor hole, no notch. 2 per box
S2043	THIN WALL ROTARY GOUGE, 2", 50mm diameter, 3/8", 10mm arbor hole, with notch. 2 per box
S2045	ROTARY GOUGE, 1 1/4", 30mm diameter, 3/8", 10mm arbor hole. 3 per box
S2046	MICRO ROTARY GOUGE, 3/4", 20mm diameter, 3/8", 10mm threaded arbor hole. 4 per box
S2047	1/2", 15mm to 3/8", 9mm REDUCER

B&J Squiggly Tool



CAUTION: Always wear eye protection.

B&J Squiggly Tool replaces 2" x 3/8" and 1/2" carbide gritted wheels for fast rubber removal with less heat buildup, lighter weight and easier control.

SQUIGGLY TOOL

Cat. No.	Description
S2020-104	24 BLADES, 2 SUPPORT PLATES 2", 50mm with 3/8", 10mm bore
S2020-101	SUPPORT PLATES, each

Piranha Rasps



CUTCO PIRANHA BUFFING RASPS

Cat. No.	Description	Diameter	Width	Grit Size	Qty.
SP204/16	FLAT FACE RASP	2"	3/16"	16	Ea.
SP204/36	FLAT FACE RASP	2"	3/16"	36	Ea.
SP208/16	FANNED FACE RASP	2"	1/2"	16	Ea.
SP208/36	FANNED FACE RASP	2"	1/2"	36	Ea.

Cut Off Wheels

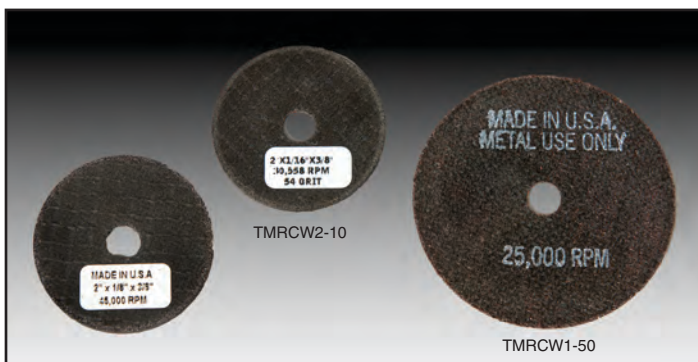

CUT OFF WHEELS

Cat. No.	Description	Size	Box Qty.
*TMRCW1-50	CUT OFF WHEEL	3" x 1/16" x 3/8"	50
*TMRCW2-10	CUT OFF WHEEL	2" x 1/16" x 3/8"	10
*TMRCW5-50	CUT OFF WHEEL	3" x 1/32" x 3/8"	50
*TMRCW10-50	CUT OFF WHEEL	3" x 3/32" x 3/8"	50
*TMRCW15-50	CUT OFF WHEEL	4" x 3/32" x 3/8"	50

*Denotes special order item

USE WITH THE FOLLOWING CHUCK ADAPTORS:

Cat. No.	Description
S1048	DRILL CHUCK SHORT ADAPTOR, 1 1/2", 40mm. 3/8", 24 thread
S1049	DRILL CHUCK LONG ADAPTOR, 2 3/4", 70mm. 3/8", 24 thread. Two nuts included.

TECH Monaflex Vulcanizing Systems

Monaflex vulcanizing systems for passenger, truck, agricultural, and OTR tires produce the ultimate tire repair when used with Tech tire repair units. Monaflex equipment is extremely portable, providing the option of distortion free section repairs in a repair facility or in the most remote job site. Monaflex systems utilize the combination of flexible rubber heat pads and air bags to provide the desired heat and pressure to vulcanize both rubber filler material in the damaged area of the tire and to the entire repair unit in one simple operation.

Tech International maintains a complete inventory of the most popular OTR and truck tire vulcanizing systems as well as replacement parts.
(Equipment requires 240 Volts AC unless specified.)

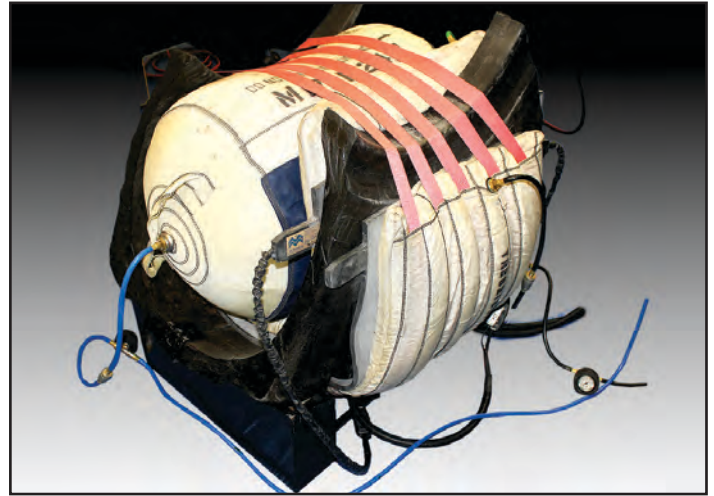
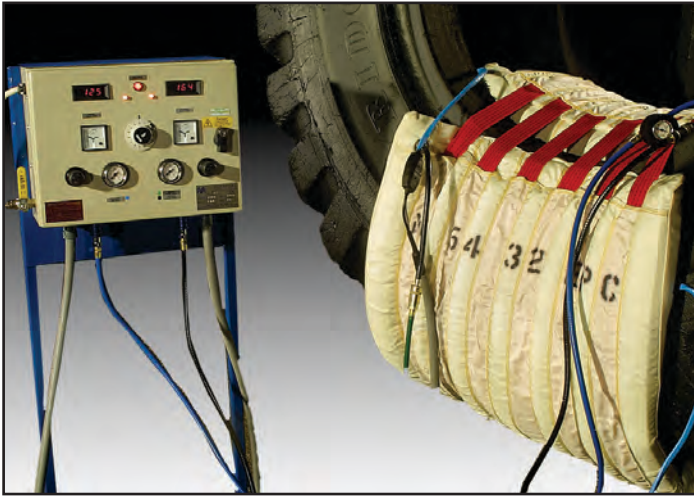

TECH Monaflex OTR System List

Monaflex OTR systems can be customized for specific tire size requirements and later expanded to cover additional tire sizes when needed.

This equipment vulcanizes the sidewall, crown, and shoulder areas of OTR tires from 13.00-24 to 55.5/85R63, Tractor and wide base tires from 14.4-24 to 45/65R45.

OTR SYSTEM FOR 14.00-24 TO 29.5-29 RADIAL AND BIAS TIRES

MONM100	1	Control Panel
MONTR1315/20W	1	Cylinder Air Bag with Window
MONM1721/24W	1	Cylinder Air Bag with Window
MONM4824W	1	Flat Air Bag with Window
MONM5432W	1	Flat Air Bag w/ window for 29.5 Radials
MONM2519H	1	Inside Heat Pad for Bias Tires
MONM2626H	1	Inside Heat Pad for Bias Tires
MONM3015H	1	Inside Heat Pad for Radial Tires
MONM4220H	1	Inside Heat Pad for Radial Tires
MONTR2621E	1	External Curing Pack
MONTR2621H	1	External Heat Pad
MONTR0CXL	5	Harness Straps (individual)

Monaflex

OTR Vulcanizing System

Radial/Bias Ply Application Chart

TIRE RANGE: OTR 13.00 TO 55.5/85-63 TRACTOR / OTR & WIDE BASE

CONTROL PANEL			M100				
Tractor/Wide Base	Tire Section	Cylinder Bag	Inside Flat Bag	Inside Heat Pad		Outside Heat Pad	External Pack With Flat Bag & Straps
				Bias	Radial		
14.4-24 to 16.9-38	13.00 to 17.5	TR1315/20W		M2519H	M3015H	TR2621H	TR2621E with TROCXL Straps
18.4-34 to 20.8-42	18.00 to 21.00	M1721/24W		M2519H OR M2626H	M3015H	TR2621H	TR2621E with TROCXL Straps
23.1-26 to 30.5-32	23.5 to 26.5	M1721/24W	M4824W	M2519H OR M2626H	M3015H	TR2621H	TR2621E with TROCXL Straps
25/65-25	27.00 to 29.5	M1721/24W	M4824W M5432W	M2519H OR M2626H	M3015H OR M4220H	TR2621H	TR2621E with TROCXL Straps
35/65-33 to 45/65-45	30.00 to 37.5	M2732/32W	M5432W	M2626H OR M3132H	M4220H OR M4224H	M2626H OR M3132H	M4832E with M45/6/7 (1HG) 6 Straps
49.5/85-57 to 50/65-51	40.00	M3842/32W		M3132H OR M2626H	M4220H OR M4224H OR M4824H OR M5224H	M2626H OR M3132H	M4832E with M45/6/7 (1HG) 6 Straps
46/90-57		M3842/32W	M5432W				
50/80-57 to 55/80-57		M4447/32W		M3132H OR M2626H	M4220H OR M4224H OR M4824H OR M5224H	M2626H OR M3132H	M4832E with M45/6/7 (1HG) 6 Straps
53.5/85-57 53.5/85-63 55.5/80-57 55.5/85-57 55.5/85-63		M4447/32W	M7532W OR M9032W	M3132H OR M2626H	M4220H OR M4224H OR M4824H OR M5224H	M2626H OR M3132H	M4832E with M45/6/7 (1HG) 6 Straps
60/60-57 70/70-57 80/70-57		M5054/32W		M3132H OR M2626H	M4220H OR M4224H OR M4824H OR M5224H	M2626H OR M3132H	M4832E with M45/6/7 (1HG) 6 Straps

TECH Monaflex Systems

Individual Components



MONAFLEX CONTROL PANEL

Monaflex OTR Control panels feature digital temperature controls, digital timers, inside and outside amp meters, air regulators and safety shut offs with an audible error alert.

Cat. No.	Description
MONM100	CONTROL PANEL, CAL9500 digital controls, 3 independent air lines, audible alarm
MONMX203	CONTROL PANEL, CAL3300 digital controls, inside/outside air lines, alarm
MONMX202	CONTROL PANEL, CAL 3300 digital controls, for small OTR and truck tire sizes

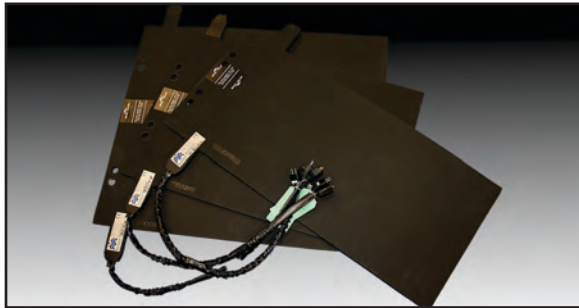

MONAFLEX HEAT PAD

Manufactured from a very durable and flexible rubber compound for long life. Pads are specifically designed for radial, bias, inside and outside tire applications. Refer to the OTR system application chart to determine proper system set up for the tire size and construction.

Cat. No.	Description
MONM2519H	HEAT PAD, Bias, 25" x 19" heated surface area
MONTR2621H	HEAT PAD, Outside, 26" x 21" heated surface area
MONM2626H	HEAT PAD, Bias or outside, 26" x 26" heated surface area
MONM3132H	HEAT PAD, Bias, 31" x 32" heated surface area
MONM3015H	HEAT PAD, Radial, 30" x 15" heated surface area
MONM4220H	HEAT PAD, Radial, 42" x 20" heated surface area
MONM4224H	HEAT PAD, Radial, 42" x 24" heated surface area
MONM4824H	HEAT PAD, Radial, 48" x 24" heated surface area
*MONM5224	HEAT PAD, Radial, 52" x 24" heated surface area



MONAFLEX CYLINDER AIR WINDOW BAG

Monaflex cylinder air bags inflate to fill out the inner cavity of the tire, providing even pressure without distortion. Cylinder Window bags are produced with a special blue elastic material that allows the bag to expand into the sidewall area of low profile and wide base tires. The bags covers are made of heat resistant nylon for strength and durability.

Cat. No.	Description
MONTR1315/20W	CYLINDER AIR BAG, 13" - 15" diameter, 20" barrel length
MONM1721/24W	CYLINDER AIR BAG, 17" - 21" diameter, 24" barrel length
MONM2732/32W	CYLINDER AIR BAG, 27" - 32" diameter, 32" barrel length
MONM3842/32W	CYLINDER AIR BAG, 38" - 42" diameter, 32" barrel length
*MONM5054/32W	CYLINDER AIR BAG, 50" - 54" diameter, 32" barrel length
MONMVS5001/202	AIR BAG HOSE, male, 16", 400mm

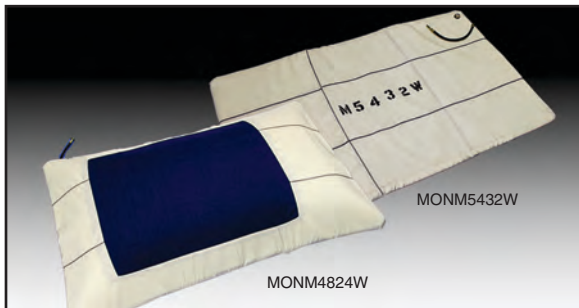

MONAFLEX FLAT AIR WINDOW BAG

Monaflex flat air bags are placed inside the tire with a cylinder air bag for certain tire sizes. This minimizes the number of cylinder air bags required to cover the full range of OTR tires.

Cat. No.	Description
MONM4824W	FLAT AIR WINDOW BAG, 48" x 24"
MONM5432W	FLAT AIR WINDOW BAG, 54" x 32"
MONM6732W	FLAT AIR WINDOW BAG, 67" x 32"
*MONM7532W	FLAT AIR WINDOW BAG, 75" x 32"



MONAFLEX EXTERNAL CURING PACK & HARNESS STRAPS

Monaflex external curing packs are produced with durable heat resistant nylon covers. The outer cover sleeve slots hold the harness straps in position and simplify equipment set up. The external curing pack provides even pressure on the outside of the tire for excellent filler rubber adhesion. **Straps sold separately.**

Cat. No.	External Curing Pack Description
MONTR2621E	26" x 21", 5 strap cover sleeve
MONM4832E	48" x 32", 6 strap cover sleeve
MONTR0CXL	Strap & buckle (5 required), used with TR2621E
MONM45/6/71HG	Harness strap set with guide, used with M4832E

*DENOTES SPECIAL ORDER ITEM

TECH Monaflex Complete OTR Vulcanizing Systems

A number of Monaflex Off-The-Road Vulcanizing Systems are available for radial and bias OTR tire ranges from 13.00-24 through 55/80 R 63, including standard, wide base and super wide base tires. The systems are assembled according to the tire size being repaired/cured. Monaflex systems may be used with chemical, cloth-backed or uncured Tech repair units.

MONOTRS SIDEWALL SYSTEM



The Monaflex OTRS sidewall system is ideal for bias and radial spot repairs and section repairs in OTR, AG, Skidder and Flotation tire sizes from 14.00-24 to 29.5-29. This system can be completely set up on the tire in less than 3 minutes. Includes the MONMX202 control panel.

OTRS REPLACEMENT PARTS

Cat. No.	Description
MONOSH2215	OUTSIDE HEAT PAD
MONOSH2815	INSIDE HEAT PAD
MONOS2117	OUTSIDE AIR BAG
MONOS2517	INSIDE AIR BAG

*MONXLOTRS SIDEWALL SYSTEM

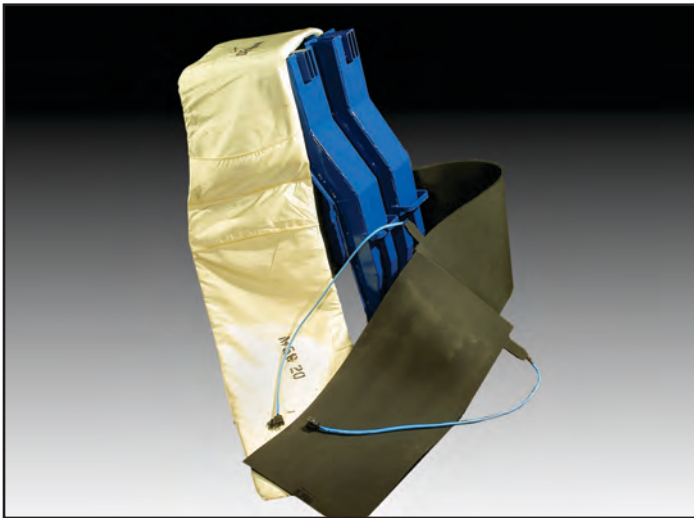

The Monaflex XLOTRS sidewall system vulcanizes spot repairs and radial section repairs in OTR tire sizes from 40.00R57 to 55.5/85R63. Steel framework allows for fast, easy set up on sidewall repairs.

*SPECIAL ORDER ITEM

*MONXLBRS BEAD REPAIR SYSTEM



The Monaflex XLBRS system vulcanizes bead repairs on 40.00R57 to 55.5/85R63 OTR tires.

*SPECIAL ORDER ITEM

TECH Monaflex Systems for Truck Tires



MONTRDD & TRRS SYSTEMS

The TRDD and TRRS systems vulcanize repairs in radial and bias truck tire range 8.25 to 12.00-24, including low profile and super single, and 9.5-32 to 12.4-38 tractor. The less expensive TRRS covers the same radial repair sizes but is limited to 7" x 7" bias repairs. The TRDD can be extended up to 23.5 OTR tires.



MONTRM SYSTEM

TRM Machine vulcanizes radial and bias tire repairs ranging from 8.25 to 12.00, 365/80 to 445/50 super singles, 13.00 to 17.5 OTR, and 9.5-32 to 16.9-28 tractor tires. This system utilizes a steel housing and fixed outside air bag for quick and easy set up.

TRM REPLACEMENT PARTS

Cat. No.	Description
MONTR911/13W	CYLINDER AIR BAG
*MONTRM4815	OUTSIDE AIR BAG
MONTR1315/15W	CYLINDER AIR BAG for Super Singles
MONTR2210H	HEAT PAD
MONTR2213H	HEAT PAD
MONM2519H	HEAT PAD

*SPECIAL ORDER ITEM

*MONSRS SIDEWALL SYSTEM



The SRS truck sidewall system vulcanizes sidewall injuries with repair units up to 6" (150mm) x 13" (330mm). Tire range is 8.25 to 445/50 super singles. Simple design requires 30 seconds to set up and operate.

*SPECIAL ORDER ITEM

*MONBRS SIDEWALL SYSTEM



The BRS truck tire bead repair system produces quick and easy bead repairs in truck tires ranging from 8.25 to 495/50 super singles. The BRS single piece design sets up and operates in less than 30 seconds.

*SPECIAL ORDER ITEM

*MONPTM SYSTEM



The PTM system vulcanizes radial and bias tire repairs in passenger, light truck and industrial tires. The steel framework and fixed outside air bag enable quick and easy operation while producing distortion free repairs. Vulcanizes the repair unit and fill rubber in one operation.

Passenger Tires: 135/70 to 245/50
Light Truck Tires: 6.50-16 to 245/70-17.5
Industrial Tires: 6.00-9 to 7.00-12

*SPECIAL ORDER ITEM

TECH Vulcanizing Equipment

The Lincoln line of products has been used by tire professionals for more than 30 years. These machines offer versatility to achieve any repair of most tires, big and small, on the market.

LINCOLN SPOTTERS

Cat. No.	Description	Shipping Weight	Optional Parts
*LINT003	TUBE PLATE SPOTTER model 200	27 lbs. / 12kg	N/A
*LINT148	ENVELOPE REPAIR SPOTTER model ERV	54 lbs. / 25kg	N/A
*LINT005	PASSENGER TIRE SPOTTER model 300	12 lbs. / 5kg	Plate Package LINT149
S1016	TRUCK TIRE SPOTTER model 400	14 lbs. / 6kg	Plate Package LINT150
S1016-220	TUBE PLATE SPOTTER model 400, 220 volt		Plate Package LINT150
*LINT009	TRACTOR TIRE SPOTTER model 500	22 lbs. / 10kg	Plate Package LINT151
*LINT011	LARGE TRUCK/TRACTOR SPOTTER, model 1000	30 lbs. / 14kg	Plate Package LINT152
*LINT018	TRACTOR/TRUCK AIR SPOTTER, model 1400	36 lbs. / 16kg	Plate Package LINT154
*LINT016	PASSENGER/LIGHT TRUCK SPOTTER, model LT	44 lbs. / 20kg	Plate Package LINT153, LINT031 Stand
*LINT029	TRUCK TIRE BEAD SPOTTER model 3100	38 lbs. / 17kg	N/A
*LINT022	MEDIUM TRUCK TIRE SPOTTER, model MT	52 lbs. / 23kg	Plate Package LINT155, LINT031 Stand
*LINT026-120	AIR OPERATED TRUCK SPOTTER, model 2000, 120 volt	74 lbs. / 30kg	Plate Package LINT156, LINT033 Stand
*LINT026-240	AIR OPERATED TRUCK SPOTTER, model 2000, 240 volt	74 lbs. / 30kg	Plate Package LINT156, LINT033 Stand

*DENOTES SPECIAL ORDER ITEM



TECH Mounting & Demounting Chemicals

Tech mounting and demounting lubricants provide excellent lubricity to make tire mounting and demounting easier when applied to the tire bead and rim mating surfaces. Tech lubricants are petroleum free with rust inhibitors to prevent rust or corrosion. These products are silicone free so they dry tacky preventing tire and rim slippage. Tech Rim Ease is a ready-to-use liquid, while Tech Mount-O-Matic is a concentrated liquid rubber lubricant. Tech Mounting Compound is a vegetable oil based lubricant which can be applied with a brush or mixed with water and applied with a swab. Tech Tire Mounting paste is a water based lubricant with rust inhibitors that goes on with a brush eliminating spills and slip hazards in the service area.



TECH MOUNTING & DEMOUNTING LUBRICANTS AND APPLICATORS

Cat. No.	Description
720	RIM EASE MOUNTING LUBRICANT, 1 gal., 3.8 liter jug
720-5G	RIM EASE MOUNTING LUBRICANT, 5 gal., 19 liter pail
720-55G	RIM EASE MOUNTING LUBRICANT, 55 gal., 209 liter drum
721	MOUNT-O-MATIC CONCENTRATE, 16 oz., 475ml
722	TECH TIRE & TUBE MOUNTING COMPOUND, 8 lb., 3.63kg
723	TECH TIRE & TUBE MOUNTING COMPOUND, 25 lb., 11.34kg
783	TECH TIRE MOUNTING PASTE, 8 lb., 3.7kg
783-5E	TECH TIRE MOUNTING PASTE, 11 lb., 5kg
963	PLASTIC FUNNEL, each
964	SWAB, each
971	ANGLED BRUSH, each



Murphy's Black Lube and Five Star Lube Rim Rust Retardant and Tire Lubricant is applied to all interior rim surfaces and to the tire beads to prevent corrosion and simplify tire mounting and demounting.

MOUNTING COMPOUNDS & PASTES

Cat. No.	Description
723M	MURPHY'S TIRE AND TUBE MOUNTING COMPOUND 25 lb., 11.34kg
725M	MURPHY'S BLACK LUBE, 35 lb., 15.9kg
NIA2539-8	FIVE STAR LUBE, 8 lb., 3.7kg
NIA2539-25	FIVE STAR LUBE, 25 lb., 11.34kg



Tech Bead Breaker is a penetrating rubber lubricant that frees stubborn beads from the rim and simplifies tire demounting.

TECH BEAD BREAKER

Cat. No.	Description
734Q	BEAD BREAKER, 1 qt., 945ml can
734	BEAD BREAKER, 1 gal., 3.8 liter can
734-5G	BEAD BREAKER, 5 gal., 19 liter
734-55G	BEAD BREAKER, 55 gal., 209 liter

CAUTION: Use in a well ventilated area away from sources of ignition.

TECH Tire & Wheel Service Lubricants

Tech service lubricants protect your investment by keeping the inner working parts of air tools and hydraulic equipment free and prolong normal wear.

Tech Precision Air Tool Oil is premium grade light weight oil used daily to keep air tools working to their full potential.

PB Blaster Air Tool Conditioner removes deposits and helps quickly restore power to air tools. PB Blaster Penetrating Catalyst is an all purpose penetrating lubricant that breaks down rust and corrosion on frozen metal fasteners and metal joints.

Markal EZ Break anti-seize prevents threads and metal moving parts from sticking in the most corrosive environments.

Five Star Super Blue Jack oil is a premium anti-wear hydraulic jack oil designed for long, trouble free operation in hydraulic jacks, car hoists, dump trucks and shock absorbers.



TECH TIRE & WHEEL SERVICE LUBRICANTS

Cat. No.	Description
753	TECH PRECISION AIR TOOL OIL, 32 oz, 945ml
PB-B	PB BLASTER PENETRATING CATALYST, 12 oz., 339g aerosol can
PB-ATC	PB BLASTER AIR TOOL CONDITIONER, CASE OF 12 12 oz, 339g aerosol cans
418-08907	MARKAL EZ BREAK ANTI-SEIZE COPPER GRADE 16 oz. 470ml, with brush cap
418-08910	MARKAL EZ BREAK ANTI-SEIZE, 10 oz. 294ml, with brush cap
NIA0422	FIVE STAR SUPER BLUE JACK OIL, 32 oz. 945ml

TECH Chemicals



TECH CHEMICALS

Cat. No.	Description
739	BUTYL RUBBER REPAIR SEALER, 16 oz, 470ml can with applicator
705C	CITRUS BASED RUBBER CLEANER, environmentally friendly rubber cleaner removes contaminants before buffing the inner liner. 32 oz, 945ml can

TECH Radio Frequency Identification Data Tags



Tech RFID Tags are perfect for commercial fleet tires, vehicle manufacturer tires, government fleet tires, aircraft and OTR tires.

Compatible with most RFID scanners and tire management software systems, Tech RFID Tags enable traceability from “cradle to grave” and also help to eliminate labels and hand written reports.

Tech RFID Tags install easily inside or outside of the tire. The cured after market style unit can be installed in hot or cold applications.

TECH RFID TAGS

Cat. No.	Description
RFAMT	CHEMICAL CURE RFID TAG for aftermarket
RFP	PRE-CAST RFID TAG for tire manufacturers
RFU	UNCURED RFID TAG for tire manufacturers

TECH Tools & Chemicals

For best results, use these products to install RFID units:



TECH TOOLS & CHEMICALS

Cat. No.	Description
760	CHEMICAL VULCANIZING FLUID Fast Dry Cement
704	RUB-O-MATIC Rubber Cleaner
738	SECURITY COAT Butyl Repair Sealer
933	RUBBER SCRAPER used with Rub-O-Matic
938	STITCHER, 1 1/2", 38mm x 1/32", 0.8mm
CP873K	LOW RPM AIR BUFFER for inner liner preparation
RH107	BUFFING WHEEL produces perfect texture for best repair adhesion
S892	TEXTURE BRUSH

TECH Tire Identification Logos

Tech Identification Logos provide a fast, simple way to identify sidewall bulge associated with radial truck repairs.

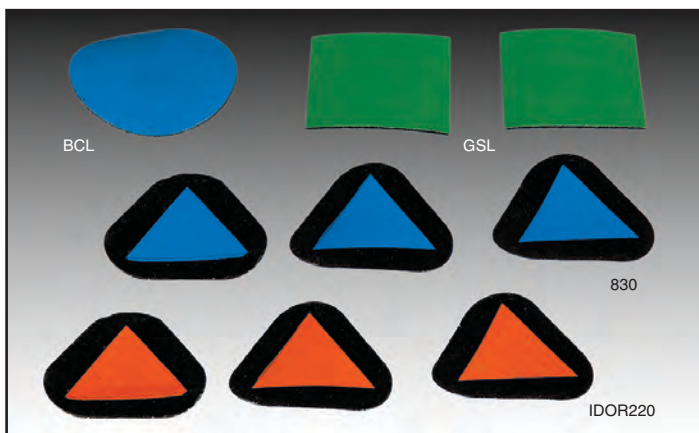

TIRE IDENTIFICATION LOGOS

Cat. No.	Description	Box Qty.
830	BLUE IDENTIFICATION TRIANGLE, 1½", 40mm	200
BCL	BLUE IDENTIFICATION CIRCLE (uncured), 1½", 40mm	200
GSL	GREEN IDENTIFICATION SQUARE (uncured), 1½", 40mm	200
IDOR220	ORANGE IDENTIFICATION TRIANGLE, 1½", 40mm	200

TECH Tire Spreaders

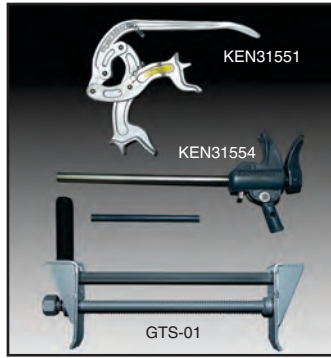

MANUAL TIRE SPREADERS

Cat. No.	Description
GTS-01	TRUCK TIRE SPREADER spread capacity 2"-15" (5cm-38cm)
KEN31551	MANUAL SPREADER WITH LOCK PIN spread capacity 4"-6" (10cm-15cm)
KEN31554	RATCHETING TIRE SPREADER spread capacity 4"-6" (10cm-15cm)

TECH PASSENGER TIRE SPREADERS

Cat. No.	Description
PS-1	Manual-operated PASSENGER/LIGHT TRUCK SPREADER WITH LIGHT. Can be adjusted to fit a whole range of passenger and light truck tires.
982	TIRE SPREADER
TMRWL98063	REPLACEMENT LIGHT ASSEMBLY



*AIR POWERED TIRE SPREADER WITH TIRE LIFT

Cat. No. BRALREF
For Passenger & Truck Tires from 13" thru 24.5" rim diameter. Spreads passenger, truck and bus tires for inspection or repair. Foot control valve conveniently located at base of machine. Adjustable light.

Shipping weight 245 lbs., 111.13kg

Optional Tire Spreader Without Tire Lift:
Order Model LR

Shipping weight 210 lbs.

***SPECIAL ORDER ITEM**



*AIR POWERED TIRE SPREADER

Cat. No. BRA5120
For Passenger & Truck Tires from 13" thru 24.5" rim diameter. Spreads passenger, truck and bus tires for inspection or repair. Foot control valve conveniently located at base of machine. Adjustable light. Convenient tool tray can be mounted on either side of the tire spreader. Spread hooks adjust with spring-loaded pins.

Shipping weight 150 lbs., 68.04kg

***SPECIAL ORDER ITEM**



*TIRE REPAIR STATION FOR PASSENGER & TRUCK TIRES

Cat. No. BRA5500
If you're looking for a stable, reliable tire repair station, the 5500 has all the features you're looking for at an affordable price. Tool tray pivots to either side on machine. Tire spread control conveniently located on both sides of platform top. Foot controls for raising/lowering platform are located on both sides of the machine. Tire ramp retracts automatically when platform is raised. 5 1/4" air cylinder lift platform using as little as 75 psi.

Shipping weight 375 lbs., 170.01kg

***SPECIAL ORDER ITEM**



TECH Lead Free Balance Pads

Tech lead free balance pads provide a "green" option of balancing the tire from the inside. In special tire service applications such as aircraft tires or large off road 4 X 4 tires, traditional exterior clip on wheel weights may not be enough to correct an out of balance condition or may become dislodged. Installation is performed using the combination of a spin balancer and the same procedures as installing a tire repair unit.

TECH BALANCE PADS – OUNCE



Cat. No.	Description	Qty.
1150	BALANCE PAD, .25 ounce	1
1151	BALANCE PAD, .5 ounce	1
1152	BALANCE PAD, .75 ounce	1
1153	BALANCE PAD, 1 ounce	1
1154	BALANCE PAD, 1.5 ounce	1
1155	BALANCE PAD, 2 ounce	1
1156	BALANCE PAD, 2.5 ounce	1
1157	BALANCE PAD, 3 ounce	1
1158	BALANCE PAD, 3.5 ounce	1
1159	BALANCE PAD, 4 ounce	1
1160	BALANCE PAD, 4.5 ounce	1
1161	BALANCE PAD, 5 ounce	1
1162	BALANCE PAD, 5.5 ounce	1
1163	BALANCE PAD, 6 ounce	1
1167	BALANCE PAD, 8 ounce	1

TECH BALANCE PADS – GRAM



Cat. No.	Description	Qty.
1181	BALANCE PAD, 30 gram	1
1182	BALANCE PAD, 50 gram	1
1183	BALANCE PAD, 75 gram	1
1184	BALANCE PAD, 100 gram	1
1185	BALANCE PAD, 125 gram	1
1186	BALANCE PAD, 150 gram	1
1187	BALANCE PAD, 175 gram	1
1188	BALANCE PAD, 200 gram	1

TECH Tools & Chemicals

For best results, use with these products:

TECH TOOLS & CHEMICALS



Cat. No.	Description
760	CHEMICAL VULCANIZING FLUID Fast Dry Cement
704	RUB-O-MATIC Rubber Cleaner
738	SECURITY COAT Butyl Repair Sealer
933	RUBBER SCRAPER used with Rub-O-Matic
938	STITCHER, 1 1/2", 38mm x 1/32", 0.8mm
CP873K	LOW RPM AIR BUFFER for inner liner preparation
RH107	BUFFING WHEEL produces perfect texture for best repair adhesion
S892	TEXTURE BRUSH

TECH PLUS Tire Balancing Compound

Tech is pleased to offer another “green” option to lead weights for improved driver comfort and extended tread life in all LT, Off Road 4x4 and Commercial Truck tire applications.

Tech Balancing compound was introduced in 1995 and is still the most durable and free flowing dry tire balancing additive, and is now TPMS compatible. Tech Plus microbeads are specially formulated to prevent static discharge which could potentially damage TPM sensors. Each Tech Plus bag includes a metal self-sealing valve cap.

An application chart is available. Ask your Tech representative or go to www.techtirerepairs.com. Click on “TRAINING”, then click on “Repair Manuals and Charts.”



TECH Tire Sealant



How Tech Plus Works

Thousands of specially coated microbeads reduce friction and maintain durability, giving you the option of reinstalling TECH PLUS in a retreaded truck tire for trailer applications.



TECH PLUS microbeads are spread evenly around interior of the tire through centrifugal force.

A tire with a heavy spot on the tread pulls the tire outwards, causing a force that results in vibration.

TECH PLUS microbeads are redistributed around the tire, creating compensating force and reducing vibration.

TECH PLUS TIRE BALANCING COMPOUND

Cat. No.	Description	Box Qty.
TLP60	TECH PLUS, 2 oz.	48
TL100	TECH PLUS, 3 oz.	36
TL150	TECH PLUS, 4.5 oz.	36
TL200	TECH PLUS, 6.5 oz.	24
TL250	TECH PLUS, 8.5 oz.	24
TM300	TECH PLUS, 10.5 oz.	20
TM400	TECH PLUS, 13 oz.	12
TM500	TECH PLUS, 16 oz.	12
TP6000	TECH PLUS, 21 oz.	8
TP7000	TECH PLUS, 23.5 oz.	8

Tech Tire Sealant effectively seals injuries caused by puncturing objects up to 3/16”, 5mm in all off-road applications. Works in tube type and tubeless tires. Remains effective for the life of the tire. Tech Tire Sealants are biodegradable and water soluble. Maintenance expenses caused by equipment downtime due to flats or hard-to-find leaks are reduced.

TECH TIRE SEALANT

Cat. No.	Description
707HD-5G	TECH PREMIUM TIRE SEALANT, 5 gal., 19L container, ea./case
708HD	TECH PREMIUM TIRE SEALANT, 32 oz., 950ml bottle, 12/case
709HD	TECH PREMIUM TIRE SEALANT, 16 oz., 470ml bottle, 12/case
711	HAND PUMP for 2½ gal., 9.5L and 5 gal., 19L containers

Application chart available. Ask your Tech representative or go to www.techtirerepairs.com. Click on “TRAINING”, then click on “Repair Manuals and Charts.”

NOTE: 708HD and 709HD are sold in case lots of 12 bottles only.

TECH TPMS Solutions Universal Sensors

Tech is pleased to offer two brands of universal Tire Pressure Monitoring System replacement sensors. Both types of sensors are produced by automotive O.E. suppliers. These Universal sensors provide over 90% vehicle coverage of the current North American automotive aftermarket, eliminating the need and cost of carrying hundreds of sensor SKU's.

Dill® Air Controls Products REDI-Sensors

Dill REDI-Sensors are preprogrammed with multiple vehicle protocols and can be used with any electronic TPMS scan tool. Three REDI-Sensors provide 90% aftermarket coverage. These sensors are ready to install with no programming required.

DILL REDI-SENSORS

Cat. No.	Description	Qty.
TPMS7001HP	REDI-SENSOR, 315 Mhz with adjustable clamp-in stem and hardware	1
TPMS7001HPR	REDI-SENSOR, 315 MHZ clamp adaptor with rubber snap-in valve	1
TPMS7002	REDI-SENSOR for Honda, Hyundai, Kia, Lexus, Toyota and others	1
TPMS7004	REDI-SENSOR, 433 Mhz with adjustable clamp-in stem and hardware	1
TPMS7020K	REDI-SENSOR service pack	1
TPMS1204A	VDO AFTERMARKET SENSOR for Lexus and Toyota, with adjustable clamp-in stem and hardware	1
TPMS1206A	VDO AFTERMARKET SENSOR for Hyundai, Kia and Toyota, with adjustable clamp-in stem and hardware	1



DILL REDI-SENSOR REPLACEMENT STEMS

Cat. No.	Description	Qty.
TPMSVS70	ALUMINUM STEM FOR DILL REDI-SENSOR	1
TPMSVS70B	BLACK ALUMINUM STEM FOR DILL REDI-SENSOR	1
TPMSVS80	RUBBER STEM FOR DILL REDI-SENSOR	1

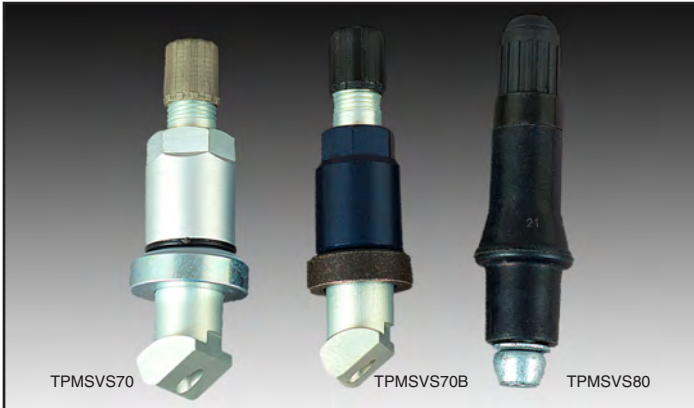

Schrader EZ-sensor programmable TPM sensors provide over 90% aftermarket coverage with only two SKU's. At the time of installation, the EZ-sensor is programmed with the exact O.E. vehicle protocol and sensor I.D. using a Bartec TPMS scan tool (EZ-sensor programming software sold separately).

SCHRADER EZ-SENSORS

Cat. No.	Description	Qty.
TPMS33000	EZ-SENSOR, 315 Mhz with rubber snap-in stem	1
TPMS33200	EZ-SENSOR, 433 Mhz with rubber snap-in stem	1
TPMS34000	ALUMINUM CLAMP-IN STYLE STEM for EZ-sensor	10
TPMS20014	SERVICE PACK FOR ALUMINUM CLAMP-IN STEM	25

EZ-sensor™



TECH TPMS Solutions Scan & Programming Tools

BARTEC

Bartec TPMS scan tools provide multiple quick, user friendly options to scan, diagnose, and report TPMS problems. Bartec Tools have EZ-sensor programming capabilities.

BARTEC 400SD SCAN TOOL



TECH400SD provides sensor PSI, temperature and battery life information, make, model, year look up, relearn procedures on the tool, OBD compatible, large backlit LCD screen, rugged design, long battery life, removable SD card or USB cable for software updates, test key fob or other RF signals.

Cat. No.	Description	Qty.
WRT400SD	TPMS SCAN TOOL with USB, OBD cables, plastic case, magnet, power supply & 1 year software updates	1
*BARWRT400SUL1	1 YEAR SOFTWARE UPDATE FOR 400 SERIES	1
*BARWRT400SUL2	2 YEAR SOFTWARE UPDATE FOR 400 SERIES	1
*BARWRT400SUL3	3 YEAR SOFTWARE UPDATE FOR 400 SERIES	1

* Denotes special order item.

BARTEC 300 SCAN TOOL SOFTWARE SUPPORT

Cat. No.	Description	Qty.
*WRT300PSDSUL1	1 YEAR SOFTWARE UPDATE FOR 300 SERIES (with OBD connect)	1
*WRT300PSDSUL2	2 YEAR SOFTWARE UPDATE FOR 300 SERIES (with OBD connect)	1
*WRT300PSDSUL3	3 YEAR SOFTWARE UPDATE FOR 300 SERIES (with OBD connect)	1

* Denotes special order item.

BARTEC TOYOTA LOOP RESET TOOL



Cat. No.	Description	Qty.
WRTRST50	BARTEC TOYOTA LOOP RESET TOOL, resets TPMS warning light stuck in "ON" position.	1

TECH

TPMS Solutions

Programming & Service Tools



BARTEC PROGRAMMING ACCESSORY PAD

Bartec TPMS PAD TPMS sensor Programming Accessory Pad connects to any PC to program the EZ-sensor. Internet connection is not required, easy to install software, USB connection. Also reads and copies mechanically damaged O.E. sensor IDs.

Cat. No.	Description	Qty.
WRTPAD1	TPMS PAD KIT includes programming pad, USB cable and software	1
*BARWRTPAD2	TPMS PAD STARTER KIT includes above items plus four 33000 and two 33100 EZ-sensors	1
*BARWRTPADSUL1	1 YEAR SOFTWARE UPDATE FOR TPMS PAD (for customers with multiple Bartec registered TPMS tools)	1
*BARWRTPADSUL2	1 YEAR SOFTWARE UPDATE (for Bartec registered accessory PAD ONLY)	1

* Denotes special order item.



DILL MASTER SERVICE KIT

Dill 8100 TPMS Master Service Kit includes all the recommended tools required to perform professional TPMS service.

Cat. No.	Description	Qty.
TPMS8100	DILL 8100 MASTER TOOL KIT includes: plastic carry case, 1/4"dr. torque wrench, 11mm, 12mm sockets, grommet tool, valve core torque tool, T-10 and T-20 Torque screwdrivers, BERU valve holding tool, 3-way fishing tool, 4-way valve nut removal wrench.	1
TPMS9700	DILL TPMS POINT OF SALE DISPLAY	1



TPMS SERVICE TOOLS

Cat. No.	Description	Qty.
TPMS5415	T-10 TORQUE SCREWDRIVER with Torx bit	1
TPMS5535	T-20 TORQUE SCREWDRIVER with Torx bit	1
TPMS55351	REPLACEMENT TORX BITS for T-20 Torque Screwdriver	5
VH609	VALVE CORE TORQUE TOOL	1
VH606	VALVE FISHING TOOL	1



KEN-TOOL RECORE TPMS SENSOR SAVER SYSTEM

Cat. No.	Description	Qty.
KEN29980	RECORE TPMS SENSOR SAVER KIT	1
KEN29981	RECORE TPMS 25 PIECE REFILL KIT	1
KEN29982	RECORE CUTTING TOOL	1
KEN29983	TAP HOLDER WITH T-HANDLE	1
KEN29984	RECORE TAP	1
KEN29985	KEN-LOK THREADLOCKER	1
KEN30060	TPMS VALVE TORQUE TOOL	1

TECH TPMS Solutions Service Packs

Tech recommends following TPMS service best practices as recommended by sensor manufacturers. Replace grommets, washers, valve cores and clamping nuts during tire replacement or whenever the sensor is removed from the wheel.

TPMS ACCESSORY KIT



7100 TPMS ACCESSORY KIT includes a full assortment of O.E. sensor service parts: valve caps and nickel plated cores, grommets, color coded application chart and packs for quick simplified selection.

Cat. No.	Description	Qty.
TPMS7100	7100 TPMS ACCESSORY KIT includes: 4-TPMS1030K, 6-TPMS1050K, 6-TPMS1060K, 6-TPMS1070K, 6-TPMS1080K, 4-TPMS1090K, 6-TPMS1100K, 6-TPMS1110K, 6-TPMS1130K, 6-TPMS2000K, 4-TPMS2010K, 4-TPMS2020K, 4-TPMS2030K, 4-TPMS2040K, 6-DILVS950-rubber stems, 4-TPMS950SC chrome sleeves, 1-valve fishing tool, 1- 4-way nut removal wrench, 20-valve cores, 20-plastic valve caps	1

REFILL SERVICE PACKS



Cat. No.	Qty.	Cat. No.	Qty.
TPMS1030K	1	TPMS1110K	1
TPMS1040K	1	TPMS1130K	1
TPMS1050K	1	TPMS2000K	1
TPMS1060K	1	TPMS2010K	1
TPMS1070K	1	TPMS2020K	1
TPMS1080K	1	TPMS2030K	1
TPMS1090K	1	TPMS2040K	1
TPMS1100K	1	TPMS7020K REDI-SENSOR	1

REPLACEMENT TPMS VALVE STEMS



Cat. No.	Description	Unit Qty.
TRI20008	RUBBER SNAP-IN STEM with torx head screw	1
TPMS925A	ALUMINUM VALVE STEM for GM, Ford, Dodge, Subaru & Suzuki	1
TPMS925B	ALUMINUM BLACK ANODIZED for GM, Ford, Dodge, Subaru & Suzuki	1
TPMS925C	CHROME VALVE STEM for GM, Ford, Dodge, Subaru & Suzuki	1
TPMS950S	SNAP IN VALVE STEM WITH CHROME SLEEVE AND CAP for GM, Subaru & Suzuki	1
TPMS950SC/4PK	SNAP IN CHROME SLEEVE AND CAP 4/PACK for TRI20008	each

TPMS TRAINING CHART



Cat. No.	Description	Qty.
TPMSRC	TPMS RELEARN CHART	1

ASK YOUR TECH REPRESENTATIVE ABOUT TPMS TRAINING PROGRAMS AND ADDITIONAL REFERENCE MATERIALS.

TECH

Valve Hardware

Tech International selects manufacturing partners who take quality as seriously as we do. Tire accessories and valve hardware manufactured by Baolong Automotive Corporation are certified according to the Quality Management System for TPMS and Tire Accessories, and have fulfilled the requirements for ISO/TS 16949:2002 certification by TUV SUD Management Services GmbH.



RUBBER SNAP-IN VALVES FOR PASSENGER & LIGHT TRUCK 65 PSI MAX

Cat. No.	TR No.	Description	Effective Length	Pkg. Qty.
TRI413/500	413	SNAP-IN TUBELESS TIRE VALVE for .453 rim hole	1¼", 32mm	500
TRI413CH/50	413	SNAP-IN TUBELESS TIRE VALVE for .453 rim hole. Chrome sleeve/cap	1¼", 32mm	50
TRI414/50	414	SNAP-IN TUBELESS TIRE VALVE for .453 rim hole	1½", 38mm	50
TRI415/50	415	SNAP-IN TUBELESS TIRE VALVE for .625 rim hole	1¼", 32mm	50
TRI418CH/100	418	SNAP-IN TUBELESS TIRE VALVE for .453 rim hole. Chrome sleeve/cap	2", 51mm	100
TRI418/500	418	SNAP-IN TUBELESS TIRE VALVE for .453 rim hole	2", 51mm	500
TRI423/50	423	SNAP-IN TUBELESS TIRE VALVE for .453 rim hole	2½", 63mm	50
TRI425	425	SNAP-IN TUBELESS TIRE VALVE for .625 rim hole	2", 51mm	1



Valves are fundamental to proper tire upkeep. It is recommended that valves be checked every three months and replaced every year or 20,000 km / 12,500 miles. Each Baolong rubber tire valve is etched with a Traceable ID so you can check the production dates without removing the valve from the rim, and manage your inventory easily on a first-in, first-out basis.

TPMS REPLACEMENT VALVE



Cat. No.	Description	Pkg. Qty.
TRI20008	RUBBER SNAP-IN STEM with T10 torx head screw	1

TECH

Valve Hardware



HIGH PRESSURE SNAP-IN VALVES – 100 PSI MAX

Cat. No.	TR No.	Description	Effective Length	Pkg. Qty.
VHI600HP	600HP	HIGH PRESSURE TUBELESS RUBBER VALVE for .453 rim hole	1¼", 32mm	1
VH602HP	602HP	HIGH PRESSURE TUBELESS RUBBER VALVE for .453 rim hole	2", 51mm	1
VHI801HP	801HP	HIGH PRESSURE TUBELESS RUBBER VALVE for .625 rim hole	1¼", 33mm	1

CLAMP-IN VALVES FOR PASSENGER & HIGH PERFORMANCE 150 PSI MAX

Cat. No.	TR No.	Description	Effective Length	Pkg. Qty.
VHI521MS	416	CLAMP-IN PASSENGER VALVE	1¼", 31mm	1
VHIV411		NICKEL PLATED VALVE with 8.3mm valve hole	1¼", 31mm	1
VHI638		ENKEI VALVE STRAIGHT	1½", 38mm	1
VHI651-45		ENKEI VALVE 45°	2", 50mm	1
VHI657		ENKEI VALVE STRAIGHT	2¼", 57mm	1
VHI662-90		ENKEI VALVE 90°	2½", 62mm	1
VHI407		METAL CLAMP-IN CHROME INNER MOUNT VALVE 6mm valve hole	1½", 39.5mm	1



CLAMP-IN VALVES FOR FORD LIGHT TRUCK – 150 PSI MAX

Cat. No.	Description	Effective Length	Pkg. Qty.
VHIV416-20/BG	FORD OE VALVE F-SERIES DUAL WHEEL	A = 1", 25mm B = 1.1", 28mm	10

HIGH PERFORMANCE TUBELESS TIRE VALVES

Cat. No.	Description	Total Length	Pkg. Qty.
VHIEV37NI-N	NICKEL PLATED VALVE, with special long nut, 11mm hex and 16mm length. Slotted flat bottom.	1½", 37mm	1
VHIEV42NI	NICKEL PLATED VALVE, with special long nut, 14mm hex and 16mm length.	1¾", 42mm	1
VHIEV42NI-N	NICKEL PLATED VALVE, with special long nut, 11mm hex and 16mm length. Improved version with nylon washer to protect rims.	1¾", 42mm	1
VHIEV42SNI	NICKEL PLATED VALVE, with special short nut, 14mm hex and 8mm length.	1¾", 42mm	1



TECH

Valve Hardware

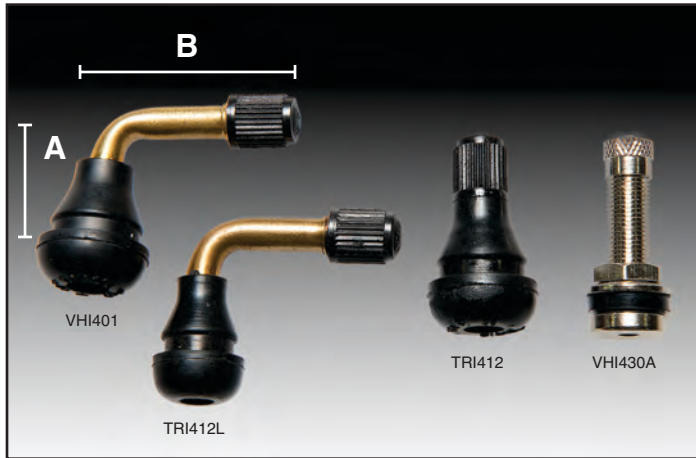

TUBELESS VALVES FOR MOTORCYCLES AND SCOOTERS

Cat. No.	Description	Effective Length	Pkg. Qty.
VHI401	SNAP-IN TUBELESS SCOOTER VALVE w/90° bend. For 8.8 rim hole	A = 1¼", 30mm B = 1¼", 30mm	1
TRI412	SNAP-IN VALVE FOR MOTORCYCLES, RALLY VEHICLES & INDUSTRIAL VEHICLES. For .453 rim hole	7/8", 25mm	1
TRI412L	SNAP-IN TUBELESS VALVE w/90° bend	A = 1¼", 31mm B = 1¼", 30mm	1
VHI430A	CLAMP-IN TUBELESS NICKEL-PLATED METAL VALVE for rim hole .327"-.339", 8.3mm-8.6mm	1¼", 30mm	1

CLAMP-IN BRASS TRUCK VALVES – 150 PSI MAX



Cat. No.	TR No.	Description	Effective Length	Pkg. Qty.
VHI722MS	575	TUBELESS BRASS STRAIGHT TRUCK VALVE	1¼", 30mm	1
VHI723MS/BG	501	TUBELESS BRASS STRAIGHT TRUCK VALVE	1½", 40mm	10
VHI724-23	500	TRUCK VALVE w/23° bend	A = 1", 26mm B = 1", 26mm	1
VHI724-23/BG	500	TRUCK VALVE w/23° bend	A = 1", 26mm B = 1", 26mm	10
VHI724MS/BG	500	TUBELESS BRASS STRAIGHT TRUCK VALVE	2", 50mm	10
VHI725MS	570	TUBELESS BRASS STRAIGHT TRUCK VALVE	3¼", 80mm	1
VHI725MS/BG	570	TUBELESS BRASS STRAIGHT TRUCK VALVE	3¼", 80mm	10
VHI72590	570	CLAMP-IN TUBELESS BRASS VALVE w/90° bend	A = 1¼", 33mm B = 2", 50mm	10
VHI726MS/BG	571	TUBELESS BRASS STRAIGHT TRUCK VALVE	3¾", 85mm	10
VHI72690	571C	CLAMP-IN TUBELESS BRASS VALVE w/90° bend	A = 1¼", 33mm B = 2¼", 58mm	1
VHI727MS/BG	572	TUBELESS BRASS STRAIGHT TRUCK VALVE	3¾", 95mm	10
VHI72790	572C	CLAMP-IN TUBELESS VALVE w/90° bend	A = 1¼", 33mm B = 2½", 67mm	1
VHI728MS/BG	573	TUBELESS BRASS STRAIGHT TRUCK VALVE	4¾", 110mm	10
VHI72890	573C	CLAMP-IN TUBELESS BRASS VALVE w/90° bend	A = 1¼", 33mm B = 3¼", 83mm	1
VHI729MS	574	TUBELESS BRASS STRAIGHT TRUCK VALVE	5", 128mm	1
VHI729MS/BG	574	TUBELESS BRASS STRAIGHT TRUCK VALVE	5", 128mm	10

TECH

Valve Hardware

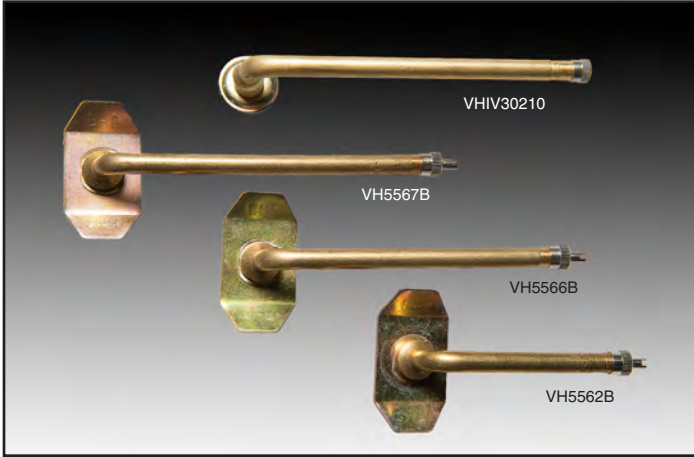

SCREW-ON BRASS VALVES

Cat. No.	TR No.	Description	Effective Length	Pkg. Qty.
VHIV30210		SINGLE BEND UNIVERSAL SCREW-ON VALVE w/94° bend	A = ¾", 20.5mm B = 4½", 115mm	1
VHIV30212		SINGLE BEND UNIVERSAL SCREW-ON VALVE w/94° bend	A = ¾", 20.5mm B = 5¼", 132mm	1
VH5562B	1075A	SCREW-ON TRUCK VALVE single bend with bridge washer	3", 75mm	1
VH5566B	1175A	SCREW-ON TRUCK VALVE single bend with bridge washer	4½", 115mm	1
VH5567B	1078A	SCREW-ON TRUCK VALVE single bend with bridge washer	5", 125mm	1

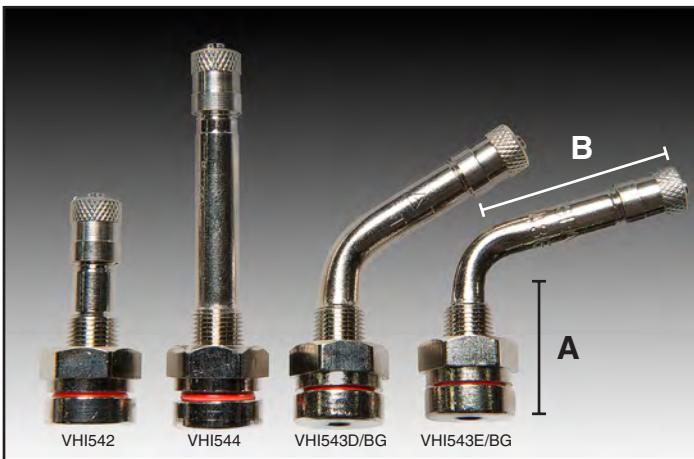

TR540 SERIES NICKEL PLATED TRUCK VALVES – 150 PSI MAX

Cat. No.	TR No.	Description	Effective Length	Pkg. Qty.
VHI542	542	STRAIGHT TRUCK VALVE	1¼", 32mm	1
VHI543/BG	543	STRAIGHT TRUCK VALVE	2¼", 59mm	10
VHI543C/BG	543C	TRUCK VALVE w/45° bend	A = 15/16", 24mm B = 13/8", 35mm	10
VHI543D/BG	543D	TRUCK VALVE w/60° bend	A = 1", 25 mm B = 13/8", 35 mm	10
VHI543E/BG	543E	TRUCK VALVE w/75° bend	A = 1", 25 mm B = 13/8", 35 mm	10
VHI544	544	STRAIGHT TRUCK VALVE	2¾", 73mm	1
VHI544/BG	544	STRAIGHT TRUCK VALVE	2¾", 73mm	10
VHI734/BG	544D	TRUCK VALVE w/60° bend	A = 1", 25 mm B = 2", 49 mm	10
VHI544E	544E	TRUCK VALVE w/75° bend	A = 1", 25 mm B = 2", 49 mm	1
VHI544E/BG	544E	TRUCK VALVE w/75° bend	A = 1", 25 mm B = 2", 49 mm	10
VHI545	545	STRAIGHT TRUCK VALVE	3½", 89mm	1
VHI545/BG	545	STRAIGHT TRUCK VALVE	3½", 89mm	10
VHI736/BG	545D	TRUCK VALVE w/60° bend	A = 1", 25 mm B = 2½", 66 mm	10
VHI545E/BG	545E	TRUCK VALVE w/75° bend	A = 1", 25 mm B = 2½", 66 mm	10
VHI546	546	STRAIGHT TRUCK VALVE	4¼", 108 mm	1
VHI546/BG	546	STRAIGHT TRUCK VALVE	4¼", 108mm	10
VHI546D	546D	TRUCK VALVE w/60° bend	A = 1", 25 mm B = 2½", 66 mm	1
VHI546D/BG	546D	TRUCK VALVE w/60° bend	A = 1", 25 mm B = 2½", 66 mm	10
VHI546E	546E	TRUCK VALVE w/75° bend	A = 1", 25 mm B = 3¼", 85 mm	1
VHI546E/BG	546E	TRUCK VALVE w/75° bend	A = 25 mm B = 3¼", 85 mm	10



TECH

Valve Hardware

VH550 SERIES VALVES for Aluminum Truck Wheels (9.7mm valve hole, 150 psi max).

Replaces VH540 series valve with a superior grommet seal design for longer sealing life, greater corrosion resistance, higher temperature range and greater tear resistance. Slotted hex base for easier installation.

VH550 SERIES VALVE STEMS – 150 PSI MAX

Cat. No.	TR No.	A	Bend	B	Nut	Pkg. Qty.
*VH552	552	1.26	–	–	HN-22	1
*VH553	553	2.4	–	–	HN-22	1
VH553C	553C	.93	45°	1.43	HN-22	1
VH553E	553E	.98	75°	1.38	HN-22	1
VH554D	554D	.98	60°	1.94	HN-22	1
VH555D	555D	.98	60°	2.6	HN-22	1
VH555E	555E	.98	75°	2.6	HN-22	1
*HALG-550	RG70	Fits .975 valve hole				1

*Replacement grommet Cat. No. HALG-550

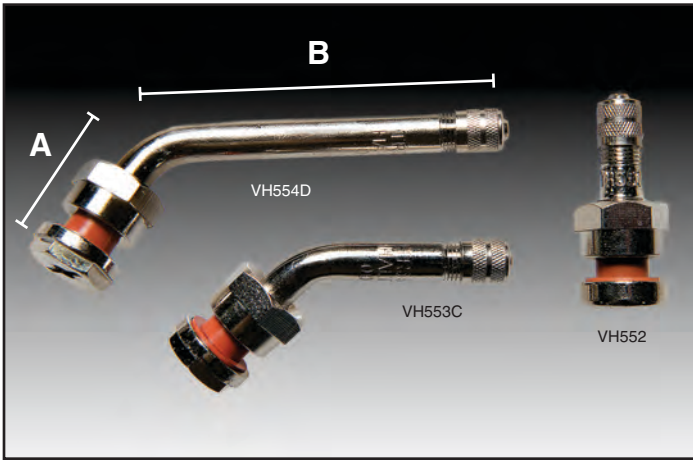

NICKEL PLATED TRUCK VALVE STEMS – 150 PSI MAX

Cat. No.	TR No.	Description	Effective Length	Pkg. Qty.
VHI755	511	TUBELESS ALUMINUM DISC VALVE STEM w/90° bend	4.25", 108 mm	1
VHI755/BG	511	TUBELESS ALUMINUM DISC VALVE STEM w/90° bend	4.25", 108 mm	10
VHI756/BG	509	TUBELESS ALUMINUM DISC VALVE STEM w/90° bend	4.75", 121 mm	10
VHI758	510	TUBELESS ALUMINUM DISC VALVE STEM w/90° bend	5.50", 140 mm	1
VHI758/BG	510	TUBELESS ALUMINUM DISC VALVE STEM w/90° bend	5.50", 140 mm	10

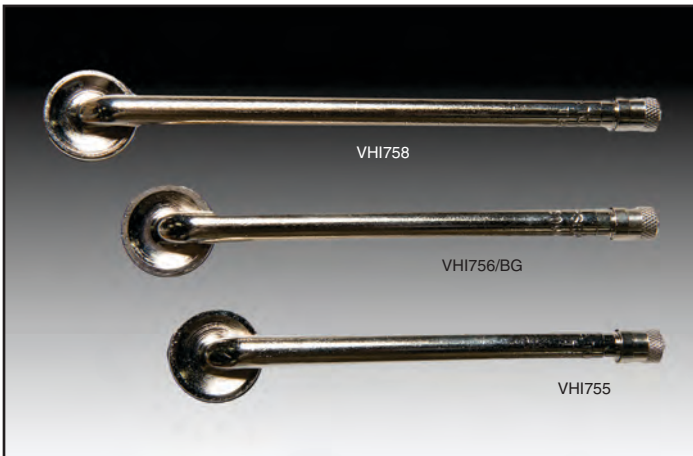

TECH

Valve Hardware

EUROPEAN STYLE NICKEL PLATED TRUCK VALVES – 150 PSI MAX



Cat. No.	Description	Effective Length	Pkg. Qty.
VHIN321	V3-20-1 NICKEL TRUCK VALVE	1½", 36mm	1
VHIN3221	V3-22-1-NICKEL O-RING SEAL CLAMP-IN w/45° bend	A = 1", 25 mm B = 1.1", 28 mm	1
VHIN323	V3-20-3 NICKEL TRUCK VALVE	¾", 82mm	1
VHIN324-27	V3-20-4 NICKEL TRUCK VALVE w/ 27° bend	A = 1", 25 mm B = 2½", 60 mm	1
VHIN325-27	V3-20-5 NICKEL TRUCK VALVE w/ 27° bend	A = 1", 25 mm B = 1½", 40 mm	1
VHIN326-27	V3-20-6 NICKEL TRUCK VALVE w/ 27° bend	A = 1", 25 mm B = 3¼", 85 mm	1
VHIN327-27	V3-20-7 NICKEL TRUCK VALVE w/ 27° bend	A = 1", 25 mm B = 2", 50 mm	1

EUROPEAN STYLE BRASS TRUCK VALVES – 150 PSI MAX



Cat. No.	Description	Effective Length	Pkg. Qty.
VHIE321	V3-20-1 BRASS TRUCK VALVE w/17.5° bend	1½", 36mm	1
VHIE32217	O-RING SEAL CLAMP-IN VALVE METRIC	A = 1¼", 30 mm B = 2½", 60 mm	1
VHIE323	V3-20-3 BRASS TRUCK VALVE	¾", 82mm	1
VHIE324-27	V3-20-4 BRASS TRUCK VALVE w/ 27° bend	A = 1", 25 mm B = 2½", 60 mm	1
VHIE325-27	V3-20-5 BRASS TRUCK VALVE w/ 27° bend	A = 1", 25 mm B = 1½", 40 mm	1
VHIE326-27	V3-20-6 BRASS TRUCK VALVE w/ 27° bend	A = 1", 25 mm B = 3¼", 85 mm	1
VHIE327-27	V3-20-7 BRASS TRUCK VALVE w/ 27° bend	A = 1", 25 mm B = 2", 50 mm	1
VHIE58MS9745	V3-22-1 METRIC O-RING SEAL CLAMP-IN VALVE w/45° bend	A = 1", 25 mm B = 1.1", 28 mm	1

EUROPEAN-STYLE CLAMP-IN VALVES FOR TRUCK AND BUS – 150 PSI MAX

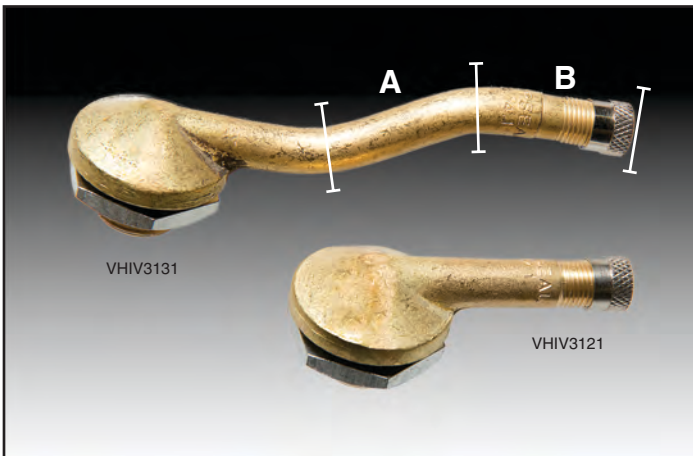

Cat. No.	Description	Effective Length	Pkg. Qty.
VHIV3121	EURO SINGLE BEND TUBELESS VALVE	A = 1½", 40 mm	1
VHIV3131	EURO DOUBLE BEND TUBELESS VALVE w/ 153° bend	A = 1¾", 46.5mm B = 1¾", 42.5 mm	1
VHIV3141	EURO TRIPLE BEND TUBELESS VALVE	B = 1", 26 mm	1

TECH

Valve Hardware



VALVE CAPS

Cat. No.	Description	Pkg. Qty.
VHCAPS	PLASTIC VALVE DUST CAPS, long version	100
VH153/1	NICKEL PLATED, LONG METAL DOME SEALING CAP	100
VH153/1S	SHORT METAL DOME SEALING CAP	1
VH60GRY	PLASTIC SEALING CAP GREY	100
VH656/58	ADAPTOR CAP to convert large bore to standard bore with cap	1
VHIVC2	NICKEL PLATED METAL SCREWDRIVER SEALING CAP	1
VHIVC8-G	LONG PLASTIC DUST CAP GREEN	1
VH82	DOUBLE SEAL VALVE CAP extends valve 1/2", 13mm OAL	100



VALVE CORES

Cat. No.	Description	Pkg. Qty.
VH430HT/1	TRC-1 HEAT RESISTANT VALVE CORE temperature range -40°F to 284°F (-40°C to 140°C)	100
VH430HT-F	FILTERED VALVE CORE high temp (shown above)	20
VHJ440	TRC-2 LONG LARGE BORE VALVE CORE	1
VHJ450	TRC-2 LARGE BORE VALVE CORE	1



GROMMETS

Cat. No.	TR No.	Description	Pkg. Qty.
VH822	TRG-46	REPLACEMENT GROMMET for VH755, VH756 and VH758 valves	1
VH823	RG-15	REPLACEMENT GROMMET for VH720 series tubeless truck tire valves	1
VH824	-	RUBBER GROMMET for Michelin replacement valve VH4567 and 6220	1
VH827	TRG-7	REPLACEMENT GROMMET for VH596, VH580, VH582 and VH584 tire valves	1
*HALG-550	RG-70	HIGHT TEMP REPLACEMENT GROMMET for 550 series valves	1
*HALG-170S	-	HIGH TEMP SILICONE REPLACEMENT GROMMET for VH720 series tubeless truck tire valves. Maximum temp. 400°F, 204°C.	1
VHJ829	RG-22	REPLACEMENT GROMMET for VHJSP2 tubeless spud	1

*Denotes special order item

TECH

Valve Hardware



PASSENGER PLASTIC VALVE EXTENSIONS

Cat. No.	Description	Length	Pkg. Qty.
VH34	PLASTIC VALVE EXTENSION	¾", 20mm	100
VH35	PLASTIC VALVE EXTENSION	1¼", 30mm	100
VH36	PLASTIC VALVE EXTENSION	1½", 40mm	100
VH37	PLASTIC VALVE EXTENSION	2", 50mm	50

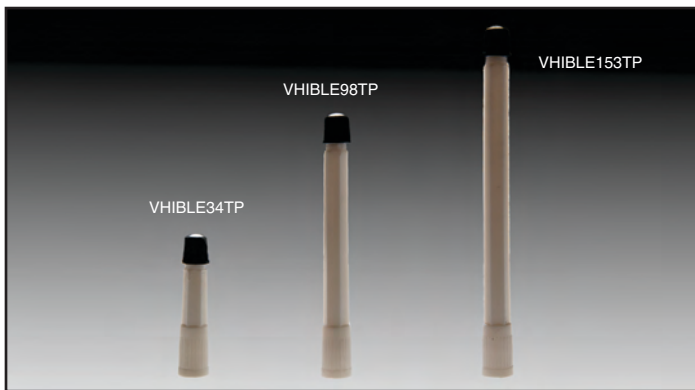

PLASTIC TRUCK VALVE EXTENSIONS

Cat. No.	Description	Length	Pkg. Qty.
VHIBLE34TP	PLASTIC TRUCK VALVE EXTENSION	1½", 33.5mm	1
VHIBLE78TP	PLASTIC TRUCK VALVE EXTENSION	3", 77mm	1
VHIBLE98TP	PLASTIC TRUCK VALVE EXTENSION	3¾", 97.5 mm	1
VHIBLE108TP	PLASTIC TRUCK VALVE EXTENSION	4¼", 107.5mm	1
VHIBLE133TP	PLASTIC TRUCK VALVE EXTENSION	5¼", 132.5mm	1
VHIBLE153TP	PLASTIC TRUCK VALVE EXTENSION	6", 152.5mm	1
VHIBLE163TP	PLASTIC TRUCK VALVE EXTENSION	6¾", 162.5mm	1



BRASS TRUCK VALVE EXTENSIONS

Cat. No.	Description	Length	Pkg. Qty.
VHIBLE29B45	BRASS TRUCK VALVE EXTENSION w/45° bend	1¼", 29mm	1
VHIBLE34B90	BRASS TRUCK VALVE EXTENSION w/90° bend	1½", 34mm	1



METAL VALVE & RIGID EXTENSIONS

Cat. No.	Description	Length	Pkg. Qty.
VH601	METAL VALVE EXTENSION	½", 13mm	1
VH602	METAL VALVE EXTENSION	¾", 20 mm	1
VH603	METAL VALVE EXTENSION	1 ¼", 30 mm	1
VH643	STRAIGHT METAL TRUCK VALVE EXTENSION	3", 75 mm	1
VH645	STRAIGHT METAL TRUCK VALVE EXTENSION	5", 125 mm	1
VH646	STRAIGHT METAL TRUCK VALVE EXTENSION	6", 150 mm	1

TECH

Valve Hardware



FLEXIBLE RUBBER VALVE EXTENSIONS

Cat. No.	Description	Length	Pkg. Qty.
VHIFVE125	RUBBER VALVE EXTENSION	4.92", 125mm	1
VHIFVE140	RUBBER VALVE EXTENSION	5.5", 140mm	1
VHIFVE160	RUBBER VALVE EXTENSION	6.3", 160mm	1
VHIFVE180	RUBBER VALVE EXTENSION	7.09", 180mm	1
VHIFVE210	RUBBER VALVE EXTENSION	8.25", 210mm	1
VHIFVE250	RUBBER VALVE EXTENSION	9.84", 250mm	1
VHIFVE280	RUBBER VALVE EXTENSION	11.03", 280mm	1



STAINLESS STEEL BRAIDED FLEXIBLE RUBBER VALVE EXTENSIONS

Cat. No.	Description	Length	Pkg. Qty.
VHIFVE160B	METAL BRAIDED FLEXIBLE VALVE EXTENSION	6.3", 160mm	1
VHIFVE180B	METAL BRAIDED FLEXIBLE VALVE EXTENSION	7", 180mm	1
VHIFVE210B	METAL BRAIDED FLEXIBLE VALVE EXTENSION	8.25", 210mm	1
VHIFVE250B	METAL BRAIDED FLEXIBLE VALVE EXTENSION	10", 250mm	1
VHIFVE270B	METAL BRAIDED FLEXIBLE VALVE EXTENSION	10.64", 270mm	1

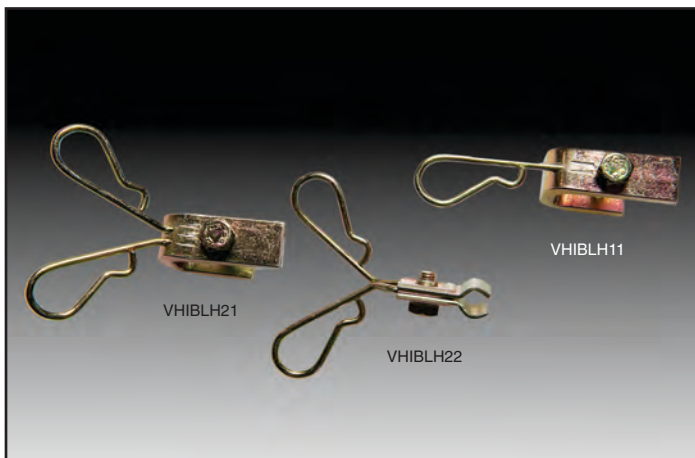

VALVE EXTENSION HOLDERS

Cat. No.	Description	Pkg. Qty.
VHIBLH11	SINGLE HOLDER FLEXIBLE VALVE EXTENSION	1
VHIBLH21	DOUBLE HOLDER FLEXIBLE VALVE EXTENSION	1
VHIBLH22	DOUBLE HOLDER FLEXIBLE VALVE EXTENSION	1

TECH

Tractor, Grader & Large Bore Valves

Tech offers a complete line of valves for agricultural, grading, material handling and earthmoving applications... anywhere liquid ballast is used. These high quality Tech products are designed to simplify air-liquid service and provide long, dependable life. Large Bore Valves are designed for when faster inflation times or air/liquid inflation are required. Air flow through Large Bore Valves is three time more than standard bore.

Mega bore and Z bore valves and hardware available by special order.



TRACTOR/GRADER VALVES/CORE HOUSINGS & EXTENSIONS

Cat. No.	TR No.	Description	Effective Length
VH580	621A	LARGE BORE TUBELESS AIR-LIQUID VALVE for .625 valve hole	4½", 115 mm with 65° bend
VH582	622A	LARGE BORE TUBELESS AIR-LIQUID VALVE for .625 valve hole	6¼", 155 mm with 90° bend
VH584	623A	LARGE BORE AIR-LIQUID VALVE for .625 valve hole	3¾", 95 mm with 65° bend
VHI594	CH-3	AGRI-CORE HOUSING for air-liquid valves	
VH595	CH-1	AGRI-CORE HOUSING, OLD TYPE	
VH597		AIR-LIQUID VALVE EXTENSION	2¾", 70 mm
VHI596	618A	LARGE BORE TUBELESS AIR-LIQUID VALVE for .625 valve hole	2", 50mm straight
VH936A	453	FRONT TUBELESS TRACTOR VALVE for .453 rim hole (not shown)	9/16", 14mm
VH936B	625	FRONT TUBELESS TRACTOR VALVE for .625 rim hole (not shown)	9/16", 14mm

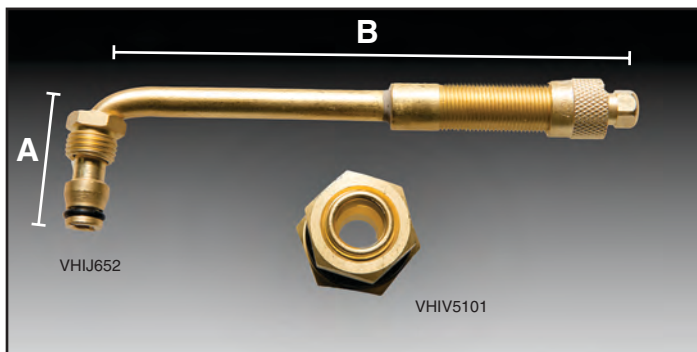

LARGE BORE SWIVEL VALVE STEMS & STRAIGHT VALVE STEMS FOR USE WITH VHJSP2 TUBELESS SPUD & VHJAD4 SWIVEL ADAPTOR

Cat. No.	TR No.	Description	Effective Length
VHIJ651		LARGE BORE SWIVEL TYPE VALVE STEM w/ Single 90° bend	A = 1¼", 32mm B = 4¾", 119mm
VHIJ652		LARGE BORE SWIVEL TYPE VALVE STEM w/ Single 86° bend	A = 1¹/₁₆", 27mm B = 5½", 140mm
VHIV5101		TUBELESS SPUD fits ¹³/₁₆", 20.5mm rim hole. Use with all large bore swivel valves.	



LARGE BORE SWIVEL VALVE STEMS FOR USE WITH VHJSP2 TUBELESS SPUD & VHJAD4 SWIVEL ADAPTOR

Cat. No.	TR No.	Bend Angle	Horizontal Length		Vertical Height	
			in.	mm	in.	mm
VHJ4450	J-4000-4½	90°	4½	115	1⁵/₆₄	27
VHJ4600	J-4000-6	90°	6	150	1⁵/₆₄	27
VHJ4750	J-4000-7½	90°	7½	190	1⁵/₆₄	27
VHJ4900	J-4000-9	90°	9	230	1⁵/₆₄	27



LARGE BORE TURRET VALVE STEM, TANK VALVE, SWIVEL VALVE ADAPTOR & TUBELESS SPUD

Cat. No.	TR No.	Description
VHB9A	B9A	Fits TR-218A and TR-220A valves to allow use of valve in the ¹³/₁₆" valve hole
VHJAD4	TRAD4	SWIVEL VALVE ADAPTOR converts tubes with SP-1000 type spud to accept large bore swivel valves
VHJSP2	SP-2	TUBELESS SPUD TR-SP2 fits ¹³/₁₆" rim hole, used with all swivel large bore valves
VHJ690	J-690	TURRET VALVE for planetary gear wheels

Tractor, Grader & Large Bore Valves

LARGE BORE EXTENSIONS



Cat. No.	Description	Length
VHJ7678	METAL VALVE EXTENSION, Large Bore	67/8", 175 mm
VHJ7734	METAL VALVE EXTENSION, Large Bore	73/4", 195 mm
VHJ7900	METAL VALVE EXTENSION, Large Bore	9", 230 mm

HAND BENDABLE EXTENSIONS



Cat. No.	Description	Length
*HAL753S-XXX	LARGE BORE HAND BENDABLE VALVE EXTENSION	Available in lengths 3.5" to 32"

CUSTOM BENT SWIVEL VALVES FOR CATERPILLAR (OE VALVES)

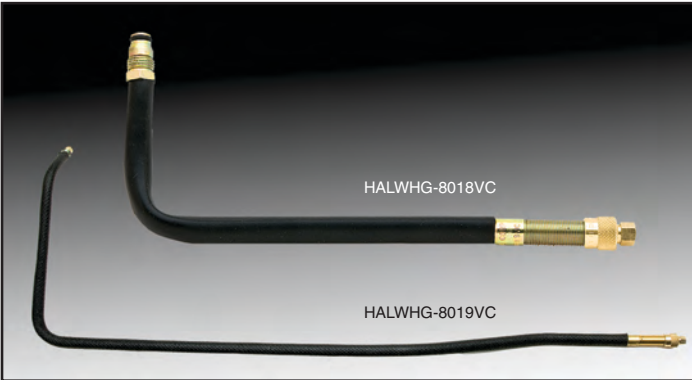

Cat. No.	Description	Length
*HALWHG-8018VC	SWIVEL VALVE with 4 bends	263/4"
*HALWHG-8019VC	SWIVEL VALVE with 1 bend	8"

*DENOTES SPECIAL ORDER ITEM

LARGE BORE VALVE CAPS AND ADAPTORS



Cat. No.	TR No.	Description	Pkg. Qty.
VHJ59	VC-6	VALVE CAP, large bore, screwdriver top	1
VHJ67	VC-7	HEX TOP for easy tightening and removal	1
VH65558	AD1	LARGE BORE HEXAGON ADAPTOR with cap (inside) converts large bore to standard bore	1
VH65658	-	LARGE BORE ROUND ADAPTOR with cap (outside) converts large bore to standard bore	1



Super Large Bore Valves & Accessories

Super Large Bore Valves are recommended for earthmover applications from 20" up to 57" when faster inflation/deflation times are required. Air flow through Super Large Bore Valves is four times faster than large bore valves. There are four key components to the SLB Valve and a unique inflator to maximize air flow.

SUPER LARGE BORE FLOW Ø .44" / 11.176mm



SLB SWIVEL VALVE AND COMPONENTS

COMPLETE SUPER LARGE BORE VALVES

Cat. No.	Description	Pkg. Qty.
*HALM-1950-8	COMPLETE SWIVEL VALVE ASSEMBLY including R-520 and T81	1
*HALM-1900-8	Same as M-1950-8 but without T-81 spud	

CLAMP-IN SPUDS

Cat. No.	Description	Pkg. Qty.
*HALT-81	TR No. SP8, 13/16" valve hole	1
*HALT-82	Same as T-81 with 1/4" additional length	1

SWIVEL ANGLE CONNECTOR

Cat. No.	Description	Pkg. Qty.
HALR-525	90° angle, screws on to spud	1
*HALR-660	60° angle (not shown)	1

FLEXIBLE EXTENSION

Cat. No.	Description	Pkg. Qty.
*HALMT-3000	FLEXIBLE EXTENSION WITH BRASS FITTINGS, 2 B-222 nuts, specify length when ordering. (MT3035 is 35" long) not shown	1

CORE HOUSING

Cat. No.	Description	Pkg. Qty.
*HALR-520	TR No. CH-8, includes cap and core	1

SUPER LARGE BORE INFLATOR ADAPTOR

Reduces inflation time by 60%, deflation time by 80%. Accepts 1/2" NPT for easy air hose connection, extracts valve core. Standard valve stem knob allows air pressure checks during inflation with a tire pressure gauge.

Cat. No.	Description	Pkg. Qty.
*HALIN-80A	SLB INFLATOR ADAPTOR	1

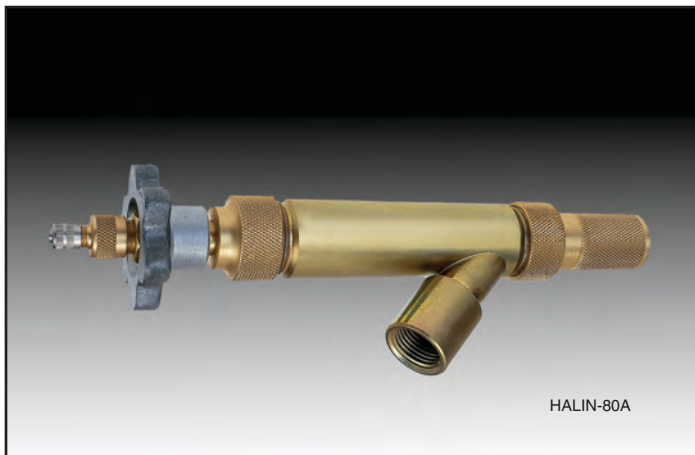

*DENOTES SPECIAL ORDER ITEM

Super Large Bore Valves & Accessories



SLB VALVE ASSEMBLY TOOLS

Cat. No.	Description	Pkg. Qty.
*HALT-620	SLB FIELD ASSEMBLY TOOL	1
*HALSLBHAT	SLB HYDRAULIC ASSEMBLY TOOL (pump not included)	1



SUPER LARGE BORE FIELD ASSEMBLY KITS

Kits include brass fittings needed to assemble one flexible SLB valve using the T-620 or SLBHAT with a hydraulic pump.

Cat. No.	Description	Pkg. Qty.
*HALR-969K-1	Includes 1 ea. R762S, R-763, 2 ea. R-764 and B-222	1
*HALR-969-K	Includes above plus 1 R-520 core housing	1
*HALR-760-50	Extension tubing 50' length	1
*HALR-760-100	Extension tubing 100' length	1



PT VALVE SYSTEM COMPONENTS

The PT Valve System allows user to monitor tire pressure with an easy to read, liquid filled dial gauge attached to the valve. Calibrated 0-160 psi.

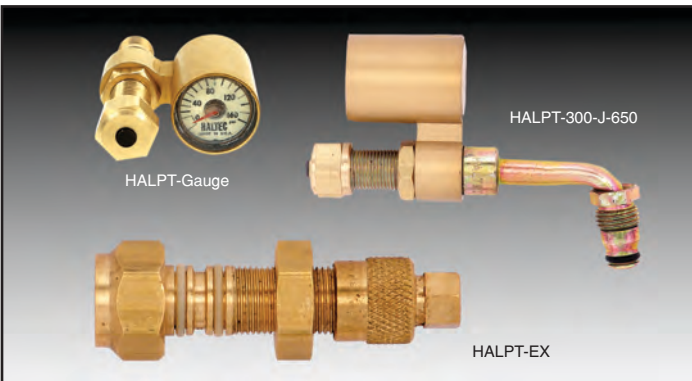

Cat. No.	Description	Pkg. Qty.
*HALPT-Gauge	LIQUID-FILLED DIAL GAUGE, easy to read	1
*HALPT-EX	LARGE BORE EXTENSION, allows for PT gauge installation on existing valves. Effective length 1 ⁵ / ₈ "	1
*HALPT-300-J-650	LARGE BORE SWIVEL VALVE with PT grooves and O-ring	1

*DENOTES SPECIAL ORDER ITEM



OTR Tire & Wheel Service Products

Haltec Standard and Arctic O-Rings for tubeless rims are manufactured to OEM specifications for a wide range of multi-piece rim O-ring grooves. O-rings are produced in a standard compound for -40°F to 180°F, and Arctic compound for -65°F to 180°F applications.

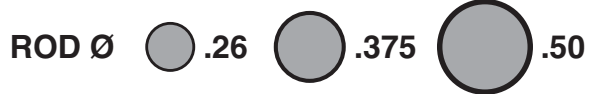

O-RINGS

Cat. No.	Application & Rim Ø	Rod Ø	Qty. Bag / Case
OR24JM	Highway (JM) 24"	.26	2 / 24
OR220TG	Grader 20"	.26	2 / 24
OR224TG	Grader 24"	.26	2 / 24
OR25T	Earthmover (small) 25"	.26	2 / 24
OR325T	Earthmover 25"	.375	2 / 24
OR329T	Earthmover 29"	.375	2 / 24
OR333T	Earthmover 33"	.375	2 / 24
OR335T	Earthmover 35"	.375	2 / 24
OR339T	Earthmover 39"	.375	2 / 24
OR345T	Earthmover 45"	.375	2 / 24
OR349T	Earthmover 49"	.375	2 / 24
OR451T	Earthmover 51"	.50	2 / 24
OR457T	Earthmover 57"	.50	2 / 24
*HALOR-215-H	Grader/Highway 15"	.28	2 / 24
*HALOR-463-T	Earthmover 63"	.50	2 / 24
*HALOR-469-T	Earthmover 69"	.50	2 / 24

*Indicates special order items.
Add suffix "A" to Cat. No. to order Arctic compound O-rings.

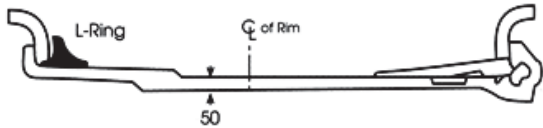
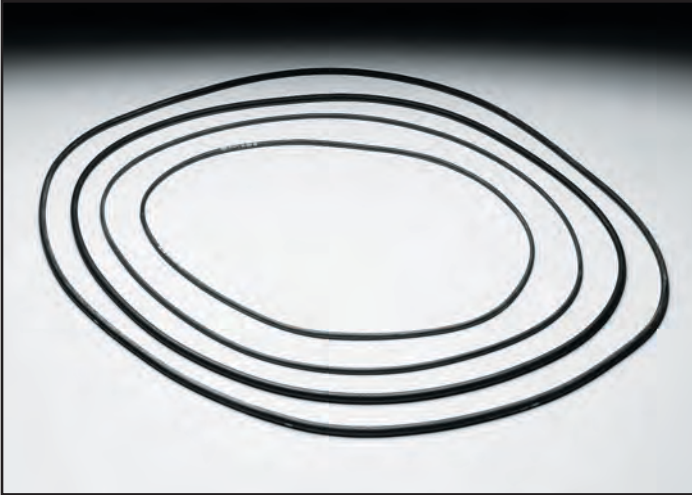

L-RING SEALS FOR EARTHMOVER RIMS

L-ring seals for earthmover rims help provide an airtight seal between the tire bead and rim bead seat area when the two components are not completely compatible.

Cat. No.	Description	Pkg. Qty.
*HALLR-25	25" L-RING SEAL	1
*HALLR-29	29" L-RING SEAL	1
*HALLR-33	33" L-RING SEAL	1
*HALLR-35	35" L-RING SEAL	1
*HALLR-39	39" L-RING SEAL	1
*HALLR-45	45" L-RING SEAL	1
*HALLR-49	49" L-RING SEAL	1
*HALLR-51	51" L-RING SEAL	1
*HALLR-57	57" L-RING SEAL	1
*HALLR-63	63" L-RING SEAL	1
*HALLR-69	69" L-RING SEAL	1

*Indicates special order items.



IMPORTANT INFORMATION

- L-ring seals are not a cure for damaged beads nor damaged wheels and rims. Caution should be used during all tire fitments. Do not install where broken bead is suspected.
- Always follow respective manufacturers' recommendation for proper bead-lubrication and initial air pressure to properly seat beads.
- If you have any questions regarding the use of the L-Ring Seals, contact Tech prior to attempting any installation.

TECH

Valve Repair Tools and Accessories

Tech valve repair tools and accessories are ideal for making valve installations, removal, and repairs easier, simpler and less time consuming. Tech has a complete line of valve installation, removal and repair tools to fit any repair person's need.

VALVE CORE REPAIR TOOLS

Cat. No.	Description
VH604	2-WAY VALVE REPAIR TOOL, combination valve core driver and deflating pin, deeply knurled for easy handling
VH605	4-WAY VALVE REPAIR TOOL, repairs and reconditions inside and outside valve threads, inserts and removes cores
VH608	HEAVY DUTY 4-WAY VALVE REPAIR TOOL, repairs and reconditions inside and outside valve threads, inserts and removes cores
VHJ608	4-WAY VALVE REPAIR TOOL, repairs and reconditions inside and outside valve threads, inserts and removes cores. Designed for large bore

VALVE CORE INSTALLATION/REMOVAL TOOLS

Cat. No.	Description
VH609	VALVE CORE TORQUE TOOL
VH670	EXTRA LONG VALVE CAP TOOL for hard to reach valve cap installation and removal (not shown)
VH673	RED HANDLE VALVE CORE TOOL for standard valve cores
VH674	HEX VALVE CORE TOOL designed for use with wrench while installing and removing valve cores
VH675	RED HANDLE VALVE CORE TOOL for large & standard valve cores
VALVEPAL	VALVE CAP REMOVER

VALVE INSTALLATION TOOLS

Cat. No.	Description
VH671	QUICK MOUNT/DEMOUNTING VALVE TOOL for snap-in tubeless tire valves
VH672	LEVER MOUNTING TOOL for snap-in tubeless tire valves
VH678	HEX NUT DRIVER with hollow shaft to accept and tighten metal valve stems

VALVE FISHING TOOLS & TUBE DEFLATORS

Cat. No.	Description
VH606	CABLE-TYPE VALVE FISHING TOOL aids in installation of tube type tires
VH607	CHAIN-TYPE VALVE FISHING TOOL aids in installation of tube type tires
VH3215	TUBE DEFLATOR – single piece screw-on deflator for rapid evacuation of air from tube
VH3216	CLIP-ON, HEAVY-DUTY TUBE DEFLATOR for rapid evacuation of air from tube

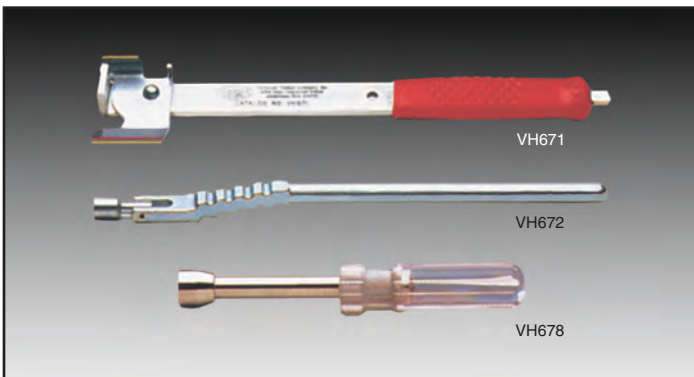
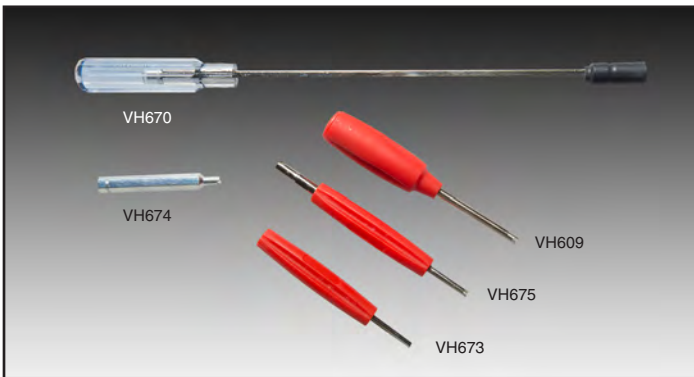

TECH

Valve Repair Tools and Accessories



VALVE CORE EJECTORS & LIQUID FILLING

Cat. No.	Description
VH598	AIR WATER ADAPTOR permits filling of tire with fluid or ballast from standard water hose
VH599	TIRE FILLING AND CORE EJECTOR for filling or evacuation of liquid from a tire. 1/2" female pipe thread will attach to calcium tire filling pumps. Adaptors included
VH599RK	REPAIR KIT FOR VH599
*HAL307	URETHANE FILL ADAPTOR attaches directly to the urethane pump discharge host with a 1/2" female pipe thread. (not shown)
*HALIN-20	PASSENGER TIRE CORE EJECTOR (shown on pg. 76)

*Denotes special order item

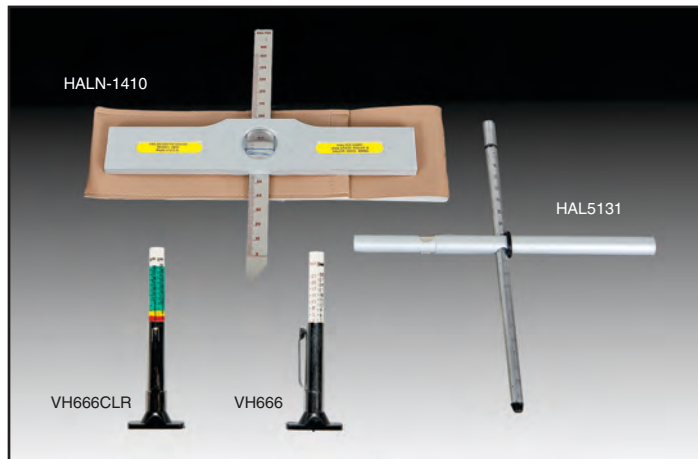

TREAD DEPTH GAUGES

Cat. No.	Description
VH666	TREAD DEPTH GAUGE, 3 sides calibrated 0-1" in 1/32" black markings. 3 sides calibrated mm in red markings.
VH666CLR	SAME AS VH666 WITH COLOR CODED SCALE
*HALN-1410	OFF-HIGHWAY TIRE TREAD DEPTH GAUGE calibrated with 32nds on one side, other side in mm. Magnified sight glass for easy readability. Includes carrying holster.
*HAL5131	OTR TREAD DEPTH GAUGE. 2 piece gauge made of slide tube and indicator. Calibrated 0-6" in 1/32" units and 7-152 mm units.

*Denotes special order item

TECH

Air/Inflating Gauges



MASTER SERVICE GAUGE & LARGE BORE GAUGES

Cat. No.	Description
VH667	MASTER SERVICE GAUGE, precision instrument for testing accuracy of tire gauges and meters. Calibrated 10–20 psi in 2 lb. units
*HALGA-255	SWIVEL GAUGE designed for large bore valves. Head adjusts to fit valves with shields, right angle or straight on. 2-sided nylon bar, one side calibrated 10–150 psi in 2 lb. units. Other side kPa 80–1040.
*HALGA-240	STRAIGHT-ON PENCIL GAUGE fits large and standard bore valves. Designed to clip in shirt pocket. 4-sided nylon bar, 2 sides calibrated 20–120 psi in 2 lb. units. Other 2 sides kPa 150–800.

*Denotes special order item

POCKET AIR GAUGES

Cat. No.	Description
VH660	AIR LIQUID TRACTOR GAUGE for air and liquid filled tires. 4-sided nylon bar, 2 sides calibrated 10–50 psi in 1 lb. units. Other 2 sides kPa 35–310.
VHI661	STANDARD PASSENGER GAUGE, 4-sided nylon bar, 2 sides calibrated 10–50 psi in 1 lb. units. Other 2 sides kPa 75–340.
VHI662	TRUCK PENCIL GAUGE, 4-sided nylon bar, 2 sides calibrated 20–120 psi in 2 lb. units. Other 2 sides kPa 150–810.
VH663	LOW-LOW PRESSURE GAUGE, 4-sided nylon bar, 2 sides calibrated 1–20 psi in ½ lb. units. Other 2 sides kPa 10–135.



DUAL FOOT AIR GAUGES

Cat. No.	Description
VHI664	DUAL FOOT TRUCK GAUGE, 4-sided nylon bar, 2 sides calibrated 20–120 psi in 2 lb. units. Other 2 sides kPa 150–810.
VHI665	DUAL FOOT SERVICE GAUGE, 2-sided nylon bar, one side calibrated 10–50 psi in 2 lb. units. Numbers at 10 lb. intervals. Other side kPa 80–1040.
VHI668	STRAIGHT PUSH-ON 30° REVERSE ANGLE SERVICE GAUGE for standard bore valves. 2-sided nylon bar, one side calibrated 10–50 psi in 2 lb. units. Numbers at 10 lb. intervals. Other side kPa 80–1040.
VHI669	STRAIGHT PUSH-ON 30° REVERSE ANGLE TRUCK GAUGE 4-sided nylon bar, 2 sides calibrated 20–120 psi in 2 lb. units. Other 2 sides kPa 150–810.



INFLATING GAUGES

Cat. No.	Description
VH651	HEAVY-DUTY INFLATING GAUGE, lightweight aluminum body with brass movement. 3-sided bar, 2 sides calibrated 10–120 psi in 2 lb. increments. One side kPa 70–800. 3 ft., .91m hose with clip-on air chuck. OSHA compliant.
VH651RH	REPLACEMENT HOSE for VH651, 3 ft., .91m (not shown)
VH652	HEAVY-DUTY INFLATING GAUGE, lightweight aluminum body with brass movement. 3-sided bar, 2 sides calibrated 10–120 psi in 2 lb. increments. One side kPa 70–800. 6 ft., 1.82m hose with clip-on air chuck. OSHA compliant.
VH652RH	REPLACEMENT HOSE for VH652, 6 ft., 1.82m (not shown)
VH653	HEAVY-DUTY INFLATING GAUGE, lightweight aluminum body with brass movement. 3-sided bar, 2 sides calibrated 10–120 psi in 2 lb. increments. One side kPa 70–800. 1 ft., .3048m hose with dual-foot chuck.

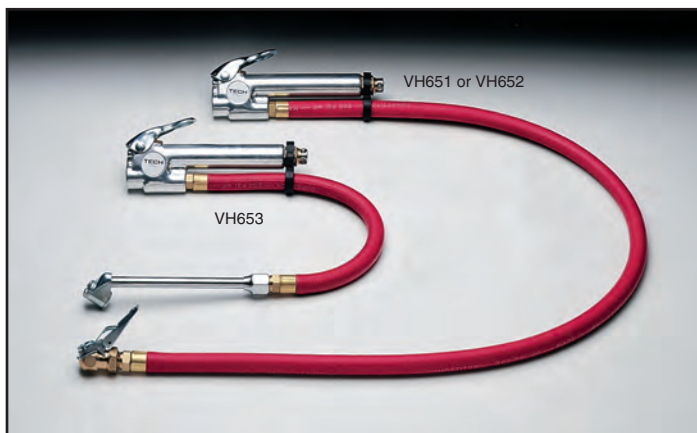

AIR SERVICE PRODUCTS

TECH

Premium Air/Inflating Gauges & Chucks

Each of Tech's premium pocket and dual foot air gauges has a high tech, epoxy coated black finish with silver trim that will withstand extended exposure to salt spray, harsh chemical environments, even petroleum products such as gasoline and oil.

Importantly, the premium dual foot design features a tapered head, which guides both the air chuck and gauge over the valve stem for a direct, positive contact seal. The tapered head reduces air seepage from around the valve for increased accuracy when inflating the tire or when gauging the tire's air pressure. The airtight seal will reduce labor time by eliminating the aggravation and time spent attempting to properly inflate tires or gauge air pressure.

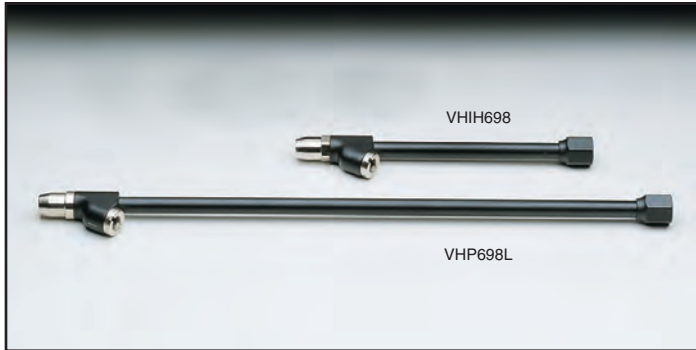

PREMIUM DUAL FOOT CHUCKS

Cat. No.	Description
VHIH698	PREMIUM DUAL FOOT STRAIGHT PUSH-ON 30° REVERSE ANGLE LOCK-ON CLOSED CHUCK, tapered head design for a positive valve contact. Straight-on/30° reverse angle closed chuck with threaded deep well lock nuts which lock onto valve when tilted. 1/4" female N.P.T., 6", 150mm length. Black and silver premium finish.
VHP698L	PREMIUM DUAL FOOT STRAIGHT PUSH-ON 30° REVERSE ANGLE EXTRA LONG LOCK-ON CLOSED CHUCK, tapered head design for a positive valve contact. Straight-on/30° reverse angle chuck with threaded deep well lock nuts which lock onto valve when tilted. Extra long 14", 355mm length for the difficult to reach tire valve. 1/4" female N.P.T. Black and silver premium finish.

PREMIUM DUAL FOOT AIR GAUGES

Cat. No.	Description
VHI665M	PREMIUM H.D. METAL BAR DUAL FOOT SERVICE GAUGE tapered head design to allow a precise fit when checking air pressure. 2-sided heavy-duty metal bar. One side calibrated in 10–150 psi in 2 lb. units. Numbers at 10 lb. intervals with 5 lb. marker between. Other side calibrated 80 to 1040 kPa. Metal and chrome finish.
VHIH668	PREMIUM STRAIGHT PUSH-ON 30° REVERSE ANGLE SERVICE GAUGE, tapered head design to allow a precise fit when using the straight chuck for inside dual wheels and a 30° reverse angle for outside wheels. 4-sided nylon bar. 2 sides calibrated 10–150 psi in 2 lb. units. Numbers at 10 lb. intervals with 5 lb. marker between. Other 2 sides calibrated 80–1040 kPa. Black and silver premium finish.



GAUGE CHECKING STATION

Cat. No.	Description
*HALGCS-A	LARGE 4" LIQUID-FILLED GAUGE, 2 lb. graduated increments, max operating pressure 160 psi. Accuracy +/- 1% full scale. Dimensions 8 ³ / ₈ " W x 7" H x 5" D. Includes in-line air filter and regulator. Works with standard and large bore air inflation gauges.

*Denotes special order item

TECH

Automatic Tire Inflators



AUTOMATIC TIRE INFLATOR & ACCESSORIES

Ideal for retail service centers and automobile dealerships.

Cat. No.	Description
*HAL89XDA	AUTOMATIC TIRE INFLATION SYSTEM, heavy duty, weatherproof. Self-calibrates every 6 minutes. Accurate to within .3 psi. 1/4" inlet and outlet.
*HAL89HKC-12	12' STRAIGHT HOSE with CH-360S AIR CHUCK
*HAL89HKC-24	24' STRAIGHT HOSE with CH-360S AIR CHUCK
*HAL89HKC-50	50' STRAIGHT HOSE with CH-360S AIR CHUCK
*HAL89HKC-25C	25' BLUE COIL HOSE with CH-360S AIR CHUCK
*HAL89HKC-50C	50' BLUE COIL HOSE with CH-360S AIR CHUCK
*HAL89HKT-12	12' STRAIGHT HOSE with COUPLER & CH-330 LO-OP AIR CHUCK
*HAL89HKT-24	24' STRAIGHT HOSE with COUPLER & CH-330 LO-OP AIR CHUCK
*HAL89HKT-50	50' STRAIGHT HOSE with COUPLER & CH-330 LO-OP AIR CHUCK
*HAL89HKT-25	25' STRAIGHT HOSE with COUPLER & IN-20 AIR CHUCK
*HAL89-2WASV	2-WAY AUTOMATIC SWITCHING VALVE (2 hoses)
*HAL89-3WASV	3-WAY AUTOMATIC SWITCHING VALVE (3 hoses)
*HAL89-3WTK	3-WAY AUTOMATIC SWITCHING VALVE KIT (tubing system)
*HALCH-360-OP-1	CLIP-ON STYLE AIR CHUCK (open)
*HALCH-330-LO-OP	LOCK ON STYLE AIR CHUCK (dual wheels)
*HALIN-20	CORE REMOVING AND INFLATION TOOL (car)
*HALSTAND-4	4' YELLOW MOUNTING STEEL STAND with SQUARE BASE

*Denotes special order item



MULTIPLE TIRE INFLATION SYSTEM & ACCESSORIES

Designed specifically for inflating large OTR tires or multiple truck tires. Ideal for fleet operations and commercial tire service centers

Cat. No.	Description
*HAL89XDB	HIGH VOLUME ELECTRONIC TIRE INFLATOR, accurate to within .3 psi. 1/2" inlet and outlet. Inflates 1-4 tire simultaneously.
*HAL89HKC-12M	12' STRAIGHT HOSE with CH-360S AIR CHUCK
*HAL89HKC-24M	24' STRAIGHT HOSE with CH-360S AIR CHUCK
*HAL89HKT-12M	12' STRAIGHT HOSE with CH-330-LO AIR CHUCK
*HAL89HKT-24M	24' STRAIGHT HOSE with CH-330-LO AIR CHUCK
*HAL89HVI-25	25' STRAIGHT HOSE with COUPLER & IN-20 AIR CHUCK (single tire application)
*HAL89-HMVN	4-WAY MANIFOLD
*HAL89-3W	AIR FLOW CONTROL VALVE
*HALCH-360S	CLIP ON STYLE CHUCK (closed) with SPRING
*HALCH-330-LO-OP	LOCK ON STYLE AIR CHUCK (dual wheels)
*HALSTAND-4	4' YELLOW MOUNTING STEEL STAND with square base

*Denotes special order item

TECH

Chucks & Chuck Repair Kits



EUROPEAN STYLE CLIP-ON AIR CHUCKS

Cat. No.	Description
VH686	CLOSED END EUROPEAN STYLE CLIP ON AIR CHUCK same as VH688 except has 1/4" N.P.T. female thread (not shown)
VH687	OPEN END EUROPEAN STYLE CLIP ON AIR CHUCK same as VH689 except has 1/4" N.P.T. female thread (not shown)
VH688	OPEN END EUROPEAN STYLE AIR CHUCK AND CLIP for use on in-line gauges, barbed end
VH689	CLOSED CHECK EUROPEAN STYLE AIR CHUCK AND CLIP, barbed end



AIR CHUCKS & CLIP

Cat. No.	Description
VHI690	BALL FOOT AIR CHUCK, 1/4" female N.P.T.
VHI691	BALL FOOT AIR CHUCK, 1/4" female N.P.T. clip firmly locks onto valve while inflating tire
VHI692	OPEN CHECK BALL FOOT AIR CHUCK AND CLIP for use on air-line gauges, 1/4" female N.P.T.
VHI693	AIR CHUCK CLIP, with heavy-duty spring, firmly holds chuck onto valve while inflating tire
VH694	OPEN CHECK LOCK-ON CHUCK securely locks onto valve when pushed forward. Released when sleeve is pulled back. For use on air-line gauges, 1/4" female N.P.T.
VH695	CLOSED CHECK LOCK-ON AIR CHUCK securely locks onto valve when pushed forward. Released when sleeve is pulled back. 1/4" female N.P.T.
VHJ6105	CLIP-ON AIR CHUCK for large bore. Locks on valve when clip is pushed forward. 1/4" female N.P.T.



DUAL FOOT CHUCKS

Cat. No.	Description
VHI696	DUAL FOOT EXTENSION CLOSED CHUCK, for hard-to-reach valves on tractor, dual-wheel truck and bus tires, 1/4" female N.P.T., nickel plated
VHI698	DUAL FOOT STRAIGHT-ON AND 30° REVERSE ANGLE LOCK-ON AIR CLOSED CHUCK, for hard-to-reach valves on tractor, dual-wheel truck and bus tires, 1/4" female N.P.T., nickel plated
VHJ6100	RIGHT ANGLE CHUCK accepts large and standard bore valves, 1/4" female N.P.T.
VHJ6102	LARGE BORE (LONG) LOCK-ON AIR CHUCK chuck locks on valve threads, 1/4" female N.P.T.

TECH

Rubber Air Hose



Tech's tough, durable EPDM rubber hose has a working pressure of 300 psi (2068 kPa). The recommended working temperature range is -40°F (-40°C) to +185°F (85°C).

RUBBER AIR HOSE

Cat. No.	Description
RAH1225	RUBBER AIR HOSE, 1/2", 15mm x 25', 7m, with fittings
RAH1250	RUBBER AIR HOSE, 1/2", 15mm x 50', 15m, with fittings
RAH12700	RUBBER AIR HOSE, 1/2", 15mm x 700', 213m
RAH14700	RUBBER AIR HOSE, 1/4", 6mm x 700', 213m
RAH3825	RUBBER AIR HOSE, 3/8", 10mm x 25', 7m, with fittings
RAH3850	RUBBER AIR HOSE, 3/8", 10mm x 50', 15m, with fittings
RAH38700	RUBBER AIR HOSE, 3/8", 10mm x 700', 213m
*AMF855	HOSE CRIMPER HEAVY DUTY, special order (not shown)
AH440	RUBBER AIR HOSE. Supply three air-operated air tools from a single hose. Aluminum manifold with 1/4" NPT threaded inlet, three 1/4" NPT threaded outlets.

*Denotes special order item

TECH Air Couplers



E-Z MATE COUPLERS

E-Z Mate Couplers eliminate back pressure during air tool connections.

Cat. No.	Description	Use With Industrial Fittings
VHCZ14	1/4" BODY, 1/4" N.P.T.	VHC27, VHC28
VHCZ12	1/2" BODY, 1/2" N.P.T.	VHC27, VHC28

TRIPLE INTERCHANGE COUPLER

Cat. No.	Description
VHC50	1/4" TRIPLE INTERCHANGE COUPLER for Industrial, Tru-flate and ARO-type nipples. Max. 150 psi.

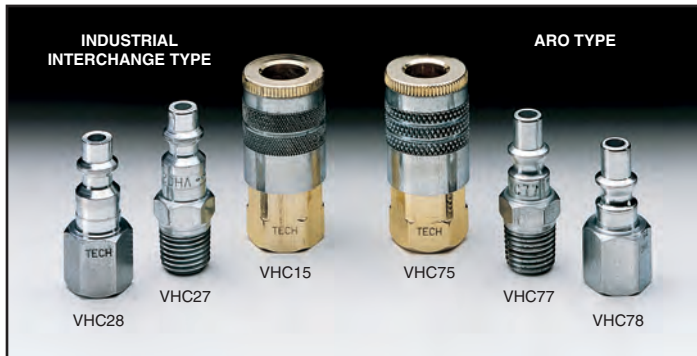

INDUSTRIAL INTERCHANGE TYPE

Cat. No.	Description
VHC15	1/4" BODY, 1/4" FEMALE N.P.T.
VHC27	1/4" NIPPLE, 1/4" MALE N.P.T.
VHC28	1/4" NIPPLE, 1/4" FEMALE N.P.T.

ARO TYPE

Cat. No.	Description
VHC75	1/4" BODY, 1/4" FEMALE N.P.T.
VHC77	1/4" NIPPLE, 1/4" MALE N.P.T.
VHC78	1/4" NIPPLE, 1/4" FEMALE N.P.T.

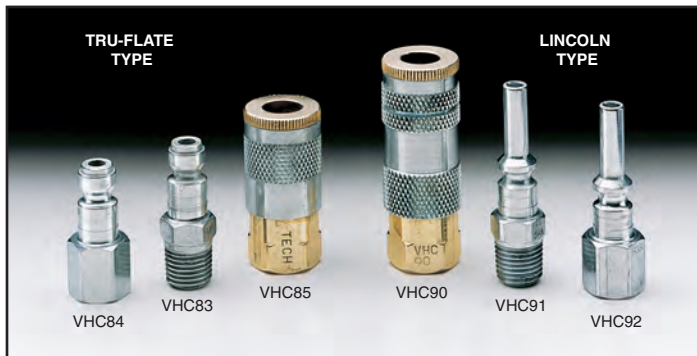

TRU-FLATE TYPE

Cat. No.	Description
VHC85	1/4" BODY, 1/4" FEMALE N.P.T.
VHC83	1/4" NIPPLE, 1/4" MALE N.P.T.
VHC84	1/4" NIPPLE, 1/4" FEMALE N.P.T.
*HALNI-106	1/4" NIPPLE, Fits 302" - 32 thread (screws directly onto truck valve system)

*Denotes special order item

LINCOLN TYPE

Cat. No.	Description
VHC90	1/4" BODY, 1/4" FEMALE N.P.T.
VHC91	1/4" NIPPLE, 1/4" MALE N.P.T.
VHC92	1/4" NIPPLE, 1/4" FEMALE N.P.T.



TRU-FLATE TYPE

Cat. No.	Description
VHC803	3/8" BODY, 1/4" FEMALE N.P.T.
VHC809	3/8" NIPPLE, 1/4" MALE N.P.T.
VHC810	3/8" NIPPLE, 1/4" FEMALE N.P.T.

TRU-FLATE TYPE

Cat. No.	Description
VHC805	3/8" BODY, 3/8" FEMALE N.P.T.
VHC807	3/8" NIPPLE, 3/8" MALE N.P.T.
VHC808	3/8" NIPPLE, 3/8" FEMALE N.P.T.

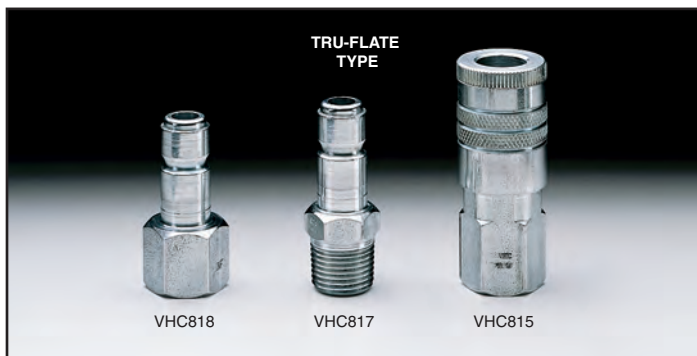

INDUSTRIAL TYPE

Cat. No.	Description
VHC37	3/8" NIPPLE, 3/8" MALE N.P.T.
VHC38	3/8" NIPPLE, 3/8" FEMALE N.P.T.

TRU-FLATE TYPE

Cat. No.	Description
VHC815	1/2" BODY, 1/2" FEMALE N.P.T.
VHC817	1/2" NIPPLE, 1/2" MALE N.P.T.
VHC818	1/4" NIPPLE, 1/2" FEMALE N.P.T.

AIR SERVICE PRODUCTS

TECH Impact Wrenches

Tech is pleased to offer a selection of high-performance impact wrenches and kits from Chicago Pneumatic. In keeping with Tech's adherence to quality, CP guarantees high performance through strict testing and quality inspections. All products are thoroughly tested in the CP Technocenter to pass EC certifications according to ISO Standards.

CHICAGO PNEUMATIC IMPACT WRENCHES

Cat. No.	Description
CP772H	HEAVY DUTY ¾" IMPACT WRENCH
CP797-6	SUPER DUTY 1" IMPACT WRENCH
*CP7729	HEAVY DUTY ½" IMPACT WRENCH
CP7733-2	HEAVY DUTY ½" IMPACT WRENCH WITH 2" (51mm) EXTENDED ANVIL
CP749-2	SUPER DUTY ½" IMPACT WRENCH
CP7782-6	1" IMPACT WRENCH WITH 6" ANVIL

*Denotes special order item



MODEL	PART NUMBER	OUTPUT DRIVE	FREE SPEED RPM	WORKING TORQUE (REV)		MAX TORQUE (FW)		AVERAGE AIR CONS.		AIR CONS. @ LOAD		OVERALL LENGTH		NET WEIGHT		AIR INLET
				FT. LB.	NM	FT. LB.	NM	CFM	L/S	CFM	L/S	IN.	MM	LB.	KG	NPTF
CP772H	T024351	¾"	4,200	150-700	203-949	1,000	1,356	6.0	2.8	24	11.3	9.6	245	10.5	4.8	¼"
CP797-6	T013901	1"	4,200	150-900	203-1,220	1,400	1,898	10.0	4.7	40	18.9	22.2	565	29.8	13.5	½"
CP7733-2	8941077332	½"	6,900	25-400	35-542	550	746	4.7	2.2	19	9.0	9.1	231	5.9	2.7	¼"
CP749-2	T024673	½"	6,400	50-450	68-610	625	827	5.5	2.6	22	10.4	9.0	229	5.8	2.6	¼"
CP7782-6	8941077B26		5,160	440-1850		2140		10								
CP871K	T025372		22,000					3.2	1.5	13	6.1	8.0	203	1.7	0.79	¼"
CP873K	T025374		2,800					3.2	1.5	13	6.1	8.3	210	2.2	1.02	¼"
CP9288	6151949288		600			14.8	20.0	6	2.8	24	11.3	9.9	251	3.3	1.51	¼"

Grey Pneumatic Impact Sockets



1/2" DRIVE FLIP SOCKETS

Cat. No.	Description	Hex Size
315-2146DT	EXTRA THIN WALL	3/4" x 13/16"
315-2192DT	EXTRA THIN WALL	19mm x 21mm
315-1504FW	THIN WALL FLIP SOCKET SET includes:	
	315-2346D	3/4" x 13/16"
	315-2349D	7/8" x 15/16"
	315-2392D	19mm x 21mm
	315-2351D	1" x 1 1/16"

315-1319 – 1/2" DRIVE FRACTIONAL IMPACT SOCKET 19 PIECE MASTER SET



19 PIECE MASTER SET includes:

Cat. No.	Size	Cat. No.	Size
315-2012R	3/8"	315-2032R	1"
315-2014R	7/16"	315-2034R	1 1/16"
315-2016R	1/2"	315-2036R	1 1/8"
315-2018R	9/16"	315-2038R	1 3/16"
315-2020R	5/8"	315-2040R	1 1/4"
315-2022R	11/16"	315-2042R	1 5/16"
315-2024R	3/4"	315-2044R	1 3/8"
315-2026R	13/16"	315-2046R	1 7/16"
315-2028R	7/8"	315-2048R	1 1/2"
315-2030R	15/16"		
315-1312	13 PIECE SET includes hex sizes 7/16" though 1 1/4"		

*Note: Replace suffix R with suffix D for Deep Well Sockets. Sockets may be ordered individually.

315-1326M – 1/2" DRIVE METRIC IMPACT SOCKET 26 PIECE MASTER SET



26 PIECE MASTER SET includes:

Cat. No.	Size	Cat. No.	Size
315-2010M	10mm	315-2023M	23mm
315-2011M	11mm	315-2024M	24mm
315-2012M	12mm	315-2025M	25mm
315-2013M	13mm	315-2026M	26mm
315-2014M	14mm	315-2027M	27mm
315-2015M	15mm	315-2028M	28mm
315-2016M	16mm	315-2029M	29mm
315-2017M	17mm	315-2030M	30mm
315-2018M	18mm	315-2032M	32mm
315-2019M	19mm	315-2033M	33mm
315-2020M	20mm	315-2034M	34mm
315-2021M	21mm	315-2035M	35mm
315-2022M	22mm	315-2036M	36mm
315-1412M	14 PIECE SET includes hex sizes 10mm through 19mm, 21mm, 22mm, 26mm and 27mm		

*Note: Use suffix MD for Deep Well Sockets. Sockets may be ordered individually.

Grey Pneumatic Impact Sockets

315-1719 – 1/2" DRIVE 12-POINT FRACTIONAL IMPACT SOCKET 19 PIECE MASTER SET



19 PIECE MASTER SET includes:

Cat. No.	Size	Cat. No.	Size
315-2112R	3/8"	315-2132R	1"
315-2114R	7/16"	315-2134R	1 1/16"
315-2116R	1/2"	315-2136R	1 1/8"
315-2118R	9/16"	315-2138R	1 3/16"
315-2120R	5/8"	315-2140R	1 1/4"
315-2122R	11/16"	315-2142R	1 5/16"
315-2124R	3/4"	315-2144R	1 3/8"
315-2126R	13/16"	315-2146R	1 7/16"
315-2128R	7/8"	315-2148R	1 1/2"
315-2130R	15/16"		

*Note: Replace suffix R with suffix D for Deep Well Sockets. Sockets may be ordered individually.

315-1726M – 1/2" DRIVE 12-POINT METRIC IMPACT SOCKET 26 PIECE MASTER SET



26 PIECE MASTER SET includes:

Cat. No.	Size	Cat. No.	Size
315-2110M	10mm	315-2123M	23mm
315-2111M	11mm	315-2124M	24mm
315-2112M	12mm	315-2125M	25mm
315-2113M	13mm	315-2126M	26mm
315-2114M	14mm	315-2127M	27mm
315-2115M	15mm	315-2128M	28mm
315-2116M	16mm	315-2129M	29mm
315-2117M	17mm	315-2130M	30mm
315-2118M	18mm	315-2132M	32mm
315-2119M	19mm	315-2133M	33mm
315-2120M	20mm	315-2134M	34mm
315-2121M	21mm	315-2135M	35mm
315-2122M	22mm	315-2136M	36mm

*Note: Use suffix MD for Deep Well Sockets. Sockets may be ordered individually.

1/2" DRIVE ADAPTORS AND EXTENSIONS



Cat. No.	Description
315-2228A	1/2" Female x 3/8" Male ADAPTOR
315-2238A	1/2" Female x 3/4" Male ADAPTOR
315-2229UJ	1/2" x 1/2" UNIVERSAL JOINT
315-2243E	3" EXTENSION
315-2243EH	3" HEAVY DUTY EXTENSION
315-2245E	5" EXTENSION
315-2245EH	5" HEAVY DUTY EXTENSION
315-2247E	7" EXTENSION

Grey Pneumatic Impact Sockets



315-8029 – 3/4" DRIVE FRACTIONAL IMPACT SOCKET 29 PIECE MASTER SET

29 PIECE MASTER SET includes:

Cat. No.	Size	Cat. No.	Size	Cat. No.	Size
315-3024R	3/4"	315-3044R	1 3/8"	315-3064R	2"
315-3026R	13/16"	315-3046R	1 7/16"	315-3066R	2 1/16"
315-3028R	7/8"	315-3048R	1 1/2"	315-3068R	2 1/8"
315-3030R	15/16"	315-3050R	1 9/16"	315-3070R	2 3/16"
315-3032R	1"	315-3052R	1 5/8"	315-3072R	2 1/4"
315-3034R	1 1/16"	315-3054R	1 11/16"	315-3074R	2 5/16"
315-3036R	1 1/8"	315-3056R	1 3/4"	315-3076R	2 3/8"
315-3038R	1 3/16"	315-3058R	1 13/16"	315-3078R	2 7/16"
315-3040R	1 1/4"	315-3060R	1 7/8"	315-3080R	2-12"
315-3042R	1 5/16"	315-3062R	1 15/16"		

*Note: Replace suffix R with suffix D for Deep Well Sockets. Sockets may be ordered individually.



315-8026M – 3/4" DRIVE METRIC IMPACT SOCKET 26 PIECE MASTER SET

26 PIECE MASTER SET includes:

Cat. No.	Size	Cat. No.	Size	Cat. No.	Size
315-3019M	19mm	315-2028M	28mm	315-3038M	38mm
315-3020M	20mm	315-3029M	29mm	315-3040M	40mm
315-3021M	21mm	315-3030M	30mm	315-3041M	41mm
315-3022M	22mm	315-3031M	31mm	315-3042M	42mm
315-3023M	23mm	315-3032M	32mm	315-3043M	43mm
315-3024M	24mm	315-3033M	33mm	315-3044M	44mm
315-3025M	25mm	315-3034M	34mm	315-3046M	46mm
315-3026M	26mm	315-3035M	35mm	315-3050M	50mm
315-3027M	27mm	315-3036M	36mm		

*Note: Use suffix MD for Deep Well Sockets. Sockets may be ordered individually.



3/4" DRIVE COMBINATION BUDD WHEEL SOCKETS

Cat. No.	Description	Hex Size	Square Size
315-3223C	COMB. BUDD WHEEL SOCKET	1 1/2"	13/16"
315-3235MC	COMB. BUDD WHEEL SOCKET	35mm	17mm
315-3241MC	COMB. BUDD WHEEL SOCKET	41mm	21mm



3/4" DRIVE ADAPTORS

Cat. No.	Socket Retention Description	Female End	Male End
315-3008A	FRICTION BALL ADAPTOR	3/4"	1/2"
315-3008AL	LOCKING PIN ADAPTOR	3/4"	1/2"
315-3009A	PIN HOLE ADAPTOR	3/4"	1"
315-3009AB	FRICTION BALL ADAPTOR	3/4"	1"
315-3009AL	LOCKING PIN ADAPTOR	3/4"	1"

Grey Pneumatic Impact Sockets



1" DRIVE FRACTIONAL SOCKETS

Cat. No.	Size	Cat. No.	Size
315-4024R	3/4"	315-4046R	1 7/16"
315-4026R	13/16"	315-4048R	1 1/2"
315-4028R	7/8"	315-4050R	1 9/16"
315-4030R	15/16"	315-4052R	1 5/8"
315-4032R	1"	315-4054R	1 11/16"
315-4034R	1 1/16"	315-4056R	1 3/4"
315-4036R	1 1/8"	315-4058R	1 13/16"
315-4038R	1 3/16"	315-4060R	1 7/8"
315-4040R	1 1/4"	315-4062R	1 15/16"
315-4042R	1 5/16"	315-4064R	2"
315-4044R	1 3/8"		

*Note: Replace suffix R with suffix D for Deep Well Sockets

1" DRIVE FRACTIONAL SOCKETS

Cat. No.	Size	Cat. No.	Size
315-4019M	19mm	315-4032M	32mm
315-4021M	21mm	315-4033M	33mm
315-4022M	22mm	315-4035M	35mm
315-4023M	23mm	315-4036M	36mm
315-4024M	24mm	315-4038M	38mm
315-4025M	25mm	315-4040M	40mm
315-4026M	26mm	315-4041M	41mm
315-4027M	27mm	315-4042M	42mm
315-4028M	28mm	315-4043M	43mm
315-4029M	29mm	315-4046M	46mm
315-4030M	30mm	315-4050M	50mm
315-4031M	31mm	315-4052M	52mm

*Note: Use suffix MD for Deep Well Sockets

1" DRIVE COMBINATION BUDD WHEEL SOCKETS

Cat. No.	Description	Hex Size	Square Size
315-4223C	COMB. BUDD WHEEL SOCKET	1 1/2"	1 3/16"
315-4235MC	COMB. BUDD WHEEL SOCKET	35mm	17mm
315-4238MC	COMB. BUDD WHEEL SOCKET	38mm	20mm
315-4241MC	COMB. BUDD WHEEL SOCKET	41mm	21mm



1" DRIVE 4-POINT (SQUARE) STANDARD LENGTH SOCKETS

Cat. No.	Description	Hex Size
315-4313S	SQUARE SOCKET	1 3/16"
315-4313SHD	HEAVY DUTY SQUARE SOCKET	1 3/16"
315-4315S	SQUARE SOCKET	1 5/16"
315-4317S	SQUARE SOCKET	17mm
315-4319S	SQUARE SOCKET	19mm
315-4320S	SQUARE SOCKET	20mm
315-4321S	SQUARE SOCKET	21mm



Grey Pneumatic Impact Sockets



1" DRIVE ADAPTORS

Cat. No.	Socket Retention Description	Female End	Male End
315-4008A	PIN HOLE ADAPTOR	1"	3/4"
315-4008AB	FRICTION BALL ADAPTOR	1"	3/4"
315-4008AL	LOCKING PIN ADAPTOR	1"	3/4"
315-4009A	PIN HOLE ADAPTOR	1"	1 1/2"



1" DRIVE EXTENSIONS

Cat. No.	Description	Retention Device
315-4003E	3" EXTENSION	PIN HOLE
315-4003EL	3" EXTENSION	LOCKING PIN
315-4007E	7" EXTENSION	PIN HOLE
315-4007EL	7" EXTENSION	LOCKING PIN
315-4010E	10" EXTENSION	PIN HOLE
315-4010EL	10" EXTENSION	LOCKING PIN
315-4013E	13" EXTENSION	PIN HOLE
315-4013EL	13" EXTENSION	LOCKING PIN



1" DRIVE UNIVERSAL JOINTS

Cat. No.	Description	Retention Device
315-4006UJ	1" X 1"	PIN HOLE
315-4006HUJ	1" X 1" HEAVY DUTY	PIN HOLE

DISMOUNT TOOL

Cat. No.	Description	Qty.
TNT-100-1	DISMOUNT TOOL - Demounts all tubeless tires 17.5" thru 24.5" and Super Singles up through 315, including most radial and bias ply tires.	Ea.
TNT-200-1	DISMOUNT TOOL FOR SUPER SINGLES Demounts tubeless tires 215 through 445, 17.5" to 24.5"	Ea.
TNT-200-M	MOUNT TOOL FOR ALL TUBELESS TIRES 17.5" to 24.5"	Ea.
TNT-100	SET INCLUDES TNT100-1 DISMOUNT AND TNT200-M MOUNT TOOLS	Ea.
TNT-200	SET INCLUDES TNT200-1 DISMOUNT AND TNT200-M MOUNT TOOLS	Ea.

DISMOUNT TOOL REPLACEMENT PARTS

Cat. No.	Description	Qty.
TNT-100-3	HANDLE GRIP	Ea.
TNT-100-8	ROLL PINS FOR TINE ROLLER	Ea.
TNT-100-9	TINE ROLLERS	Ea.
TNT-100-10	MAIN ROLLER	Ea.
TNT-100-11	ROLL PIN FOR MAIN ROLLER	Ea.

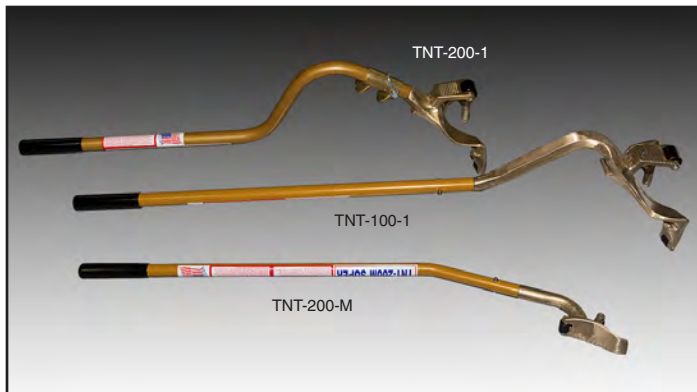

TECH

Wheel Fasteners & Service Tools

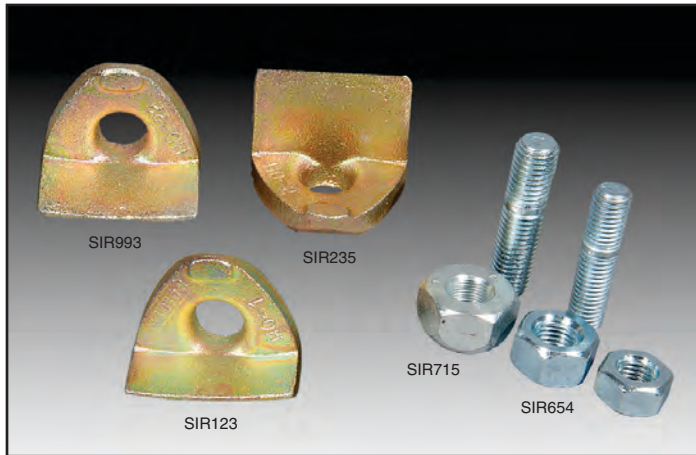

DAYTON DEMOUNTABLE FASTENERS

Cat. No.	Description	Box Qty.
SIR715	DAYTON WHEEL STUD, 3/4"	50
SIR716	DAYTON HEX NUT, 3/4"	50
SIR149	DAYTON HEX NUT, 5/8"	100
SIR654	DAYTON WHEEL STUD, 5/8"	50
SIR993	H22 RIM CLAMP, 1 1/2"	10
SIR123	H01 RIM CLAMP, 1 1/8"	10
SIR235	H02 RIM CLAMP, 1 3/4"	10

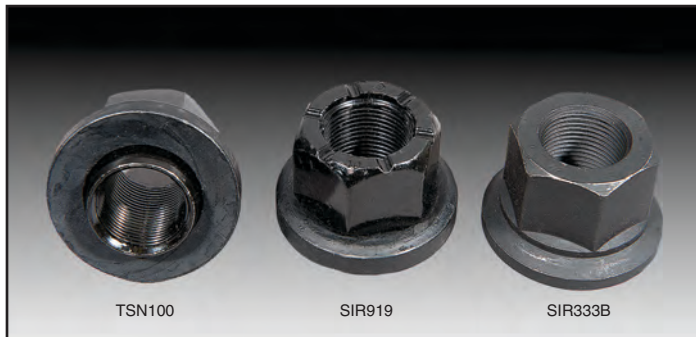

FLANGE NUTS FOR HUB PILOT WHEELS

Cat. No.	Description	Box Qty.
SIR333B	HEX FLANGE NUT, 33mm	25
SIR919	HEX FLANGE NUT, 30mm	10
TSN100	M22 HEX SKIRT FLANGE NUT, 33mm	10

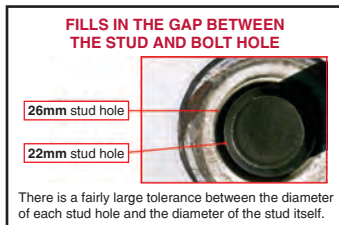

Skirt Nuts (left) reduce tolerances between studs and bolt holes in Hub Pilot wheels to reduce vibration and improve tread wear.



CAP NUTS FOR STUD PILOT WHEELS

Cat. No.	Description	Box Qty.
SIR304L	METRIC OUTER CAP NUT, left	10
SIR304R	METRIC OUTER CAP NUT, right	10
SIR306L	METRIC INNER CAP NUT, left	10
SIR306R	METRIC INNER CAP NUT, right	10
SIR708ARY	INNER CAP NUT, right, 27/32"	25
SIR709ALY	INNER CAP NUT, left, 27/32"	25
SIR888RZ	OUTER CAP NUT, right	25
SIR889LZ	OUTER CAP NUT, left	25
SIR892ALY	OUTER CAP NUT, left	25
SIR896RY	INNER CAP NUT, right, 29/16"	25
SIR896LY	INNER CAP NUT, left, 29/16"	25
SIR897RY	INNER CAP NUT, right, 31/16"	25
SIR897LY	INNER CAP NUT, left, 31/16"	25
SIR912R	EXTREME DUTY OUTER BUDD NUT, right	25
SIR913L	EXTREME DUTY OUTER BUDD NUT, left	25
SIR988LY	INNER CAP NUT, right, 31/16"	25
SIR988RY	INNER CAP NUT, left, 31/16"	25

TECH

Wheel Service Tools

Wheel and Rim manufacturers and OSHA regulations state that rim mating surfaces and threads of hub and wheel assemblies must be free from rust and corrosion. Tech is pleased to offer new stud cleaning tools that make the job quick and easy. These tools have replaceable brushes and can be used with an impact wrench or drill.

NOTE: ALWAYS WEAR EYE PROTECTION AND A MASK WHEN CLEANING CORRODED METAL SURFACES.

STUD CLEANING TOOLS



Cat. No.	Description	Box Qty.
SBCT16	STUD CLEANING TOOL, 5/8", 16mm	1
SCBR16	REPLACEMENT BRUSH, 5/8", 16mm	1
SBCT22	STUD CLEANING TOOL, 7/8", 22mm	1
SCBR22	REPLACEMENT BRUSH, 7/8", 22mm	1

RIM CLEANING BRUSHES

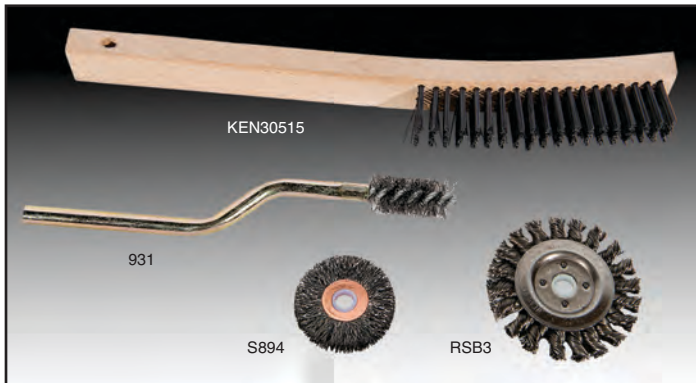

Cat. No.	Description	Box Qty.
S894	COARSE WIRE WHEEL, 2"	1
RSB3	TWISTED WIRE BRUSH, 3"	1
931	VALVE HOLE CLEANING BRUSH	1
KEN30515	HAND HELD WIRE BRUSH	1

KENTOOL CAP NUT WRENCHES



Cat. No.	Description	Box Qty.
KEN30165	DUAL WHEEL STUD REMOVER	1
KEN30618	TX241 HEAVY DUTY CAP NUT WRENCH, 41mm	1
KEN30620	TX50 COMBINATION CAP NUT WRENCH	1

ESCO NUT AND STUD REMOVERS

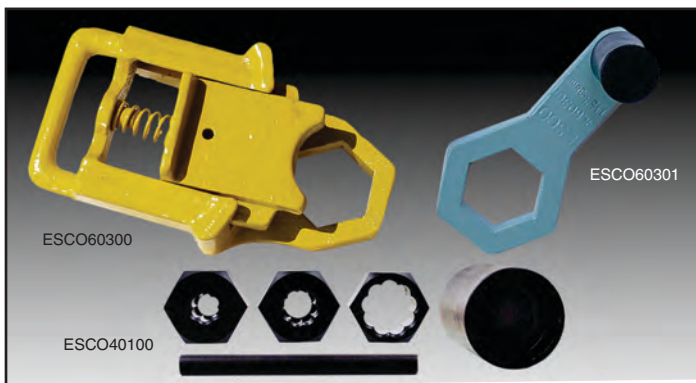

Cat. No.	Description	Box Qty.
*ESCO40100	5 PIECE KIT, removes 3/4" and 5/8" studs, and 1 1/8" inner cap nuts	1
*ESCO40107	BUDD INNER CAP NUT REMOVER, 1 1/8"	1
*ESCO60300	DELUXE BUDD NUT WRENCH	1
*ESCO60301	PORK CHOP STYLE CAP NUT WRENCH, 1 1/2", 38mm	1

*Denotes special order item

TECH

Wheel Service Tools

Save-a-Stud Kits repair damaged threads on wheel studs, saving time and money. Wheel protectors prevent steel or aluminum rims from being scratched during fastener installation and removal. Save-a-Stud Kits feature a patented hinged design threaded dyes. Lifetime guarantee.

E-Z Wheel Guards provide a thin barrier between wheel and hub mating surfaces or between dual wheels, preventing seized rims and galvanic corrosion from aluminum to steel contact.



SAVE-A-STUD KITS

Cat. No.	Description	Box Qty.
*ESCO30120	8 PIECE KIT includes sizes: 7/16"-20, 1/2"-20, 9/16"-18, 5/8"-18, 12mm-1.25, 12mm-1.50, 12mm-1.75, 14mm-1.50	1
*ESCO30125	3 PIECE KIT includes sizes: 3/4"-16 right, 3/4"-16 left, 22-1.5mm	1

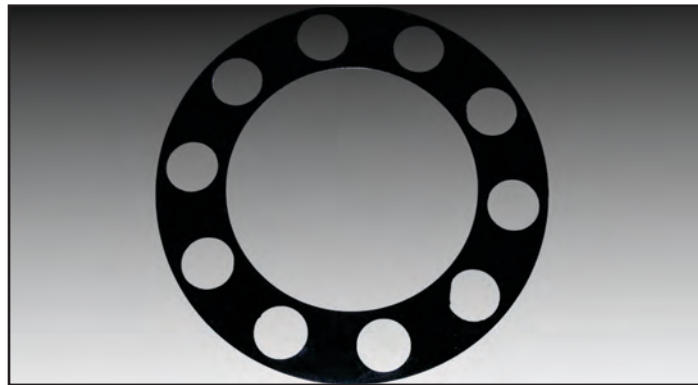

WHEEL PROTECTORS

Cat. No.	Description	Box Qty.
990	STANDARD TOUGH POLYMER MATERIAL	1
*ESCO50303	EXTRA TOUGH MATERIAL lasts 20 times longer than standard guard	1

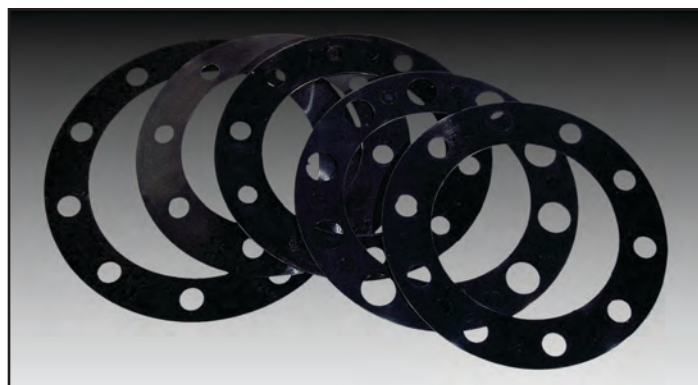

E-Z WHEEL GUARDS (SOLD INDIVIDUALLY)

Cat. No.	Hole Count	Bolt Circle	Stud Diameter	Wheel Application
*ESCO60100	10	11 1/4"	1 1/8", 7/8"	Stud Piloted
*ESCO60101	10	11 1/4"	3/4"	Stud Piloted
*ESCO60102	10	285.75mm	22mm	Hub Piloted
*ESCO60104	10	335mm	22mm	Hub Piloted
*ESCO60105	8	275mm	20mm	Hub Piloted
*ESCO60106	8	6 1/2"	4.82" ID, 5/8"	GM & Dodge
*ESCO60107	8	6 1/2"	5.25" ID, 5/8"	Oval Holes, Ford
*ESCO60108	8	225mm	6.75" ID, 5/8"	Locating Holes Ford 19.5"
*ESCO60109	10	335mm, 13.189"	22mm	Budd Axle: Bus Wheels



CHROME LUG NUT PLIERS

Cat. No.	Description	Box Qty.
KEN30606	STANDARD CHROME NUT PULLER	1
*ESCO50100	DELUXE CHROME NUT PLIERS	1

*Denotes special order item

ESCO Bead Breakers & OTR Tire Service Accessories



ESCO BEAD BREAKERS

Cat. No.	Description	Unit Weight
E10100	GIANT TIRE/EARTH MOVER BEAD BREAKER Use on 5-piece rims 25" to 51" with pry bar/bead loosening pockets.	31 lb.
E10101	COMBI BEAD BREAKER, works on single, two and three-piece truck tires/rims, including some new style wheels.	36 lb.
*ESCO10102	MAXI BEAD BREAKER, newly designed, works on all 3-piece wheels that replace older 5-piece wheels. Designed to work on front or back of wheel with no attachments or accessories.	38 lb.
E70160	MANUAL BEAD BREAKER	12 lb.



ESCO BREAKER KITS

Cat. No.	Description	Unit Weight
*ESCO10207	BEAD BREAKER KIT FOR E10100, contains E10100 bead breaker, ESCO10500 3.5 quart pump, hose, and all couplers and adaptors.	57 lb.
*ESCO10209	BEAD BREAKER KIT FOR E10100, contains E10100 bead breaker, ESCO10592 5 quart pump, hose, and all couplers and adaptors.	68 lb.
*ESCO10200	BEAD BREAKER KIT FOR E10101, contains E10101 bead breaker, ESCO10500 3.5 quart pump, hose, and all couplers and adaptors.	60 lb.
*ESCO10202	BEAD BREAKER KIT FOR E10101, contains E10101 bead breaker, ESCO10592 5 quart pump, hose, and all couplers and adaptors.	71 lb.



ESCO PUMPS

Cat. No.	Description	Unit Weight
E10500	TURBO II AIR/HYDRAULIC PUMP 3.5 quart oil capacity	18 lb.
*ESCO10543M	CALCIUM CHLORIDE PUMP, pumps 34 gallons of calcium chloride per minute. Newly designed valve will not leak. Double diaphragm pump, 1:1 ratio, 10 foot hoses.	44 lb.
*ESCO10592	AIR/HYDRAULIC PUMP, 5 quart oil capacity	27 lb.



ESCO JACKS

Cat. No.	Description	Unit Weight
E10312	LIGHTWEIGHT ALUMINUM JACK, 55 TON	33 lb.
*ESCO10300	ALUMINUM JACK, 100 TON	55 lb.



ESCO TIRE MOUNT & DEMOUNT TOOLS

Cat. No.	Description	Unit Weight
*ESCO70100	EASY-WAY™ TUBELESS TRUCK TIRE DEMOUNTING SYSTEM	37 lb.
E70150	QUALITY HEAVY DUTY SLIDE HAMMER handles all tubeless truck tires 16.5"-24.5" diameter	24 lb.

*Denotes special order item

TECH

Bead Breakers & OTR Tire Service Accessories

Tech International is pleased to offer AME, the world leader in tire changing and lifting equipment. AME offers a complete line of bead breakers, pumps and rams. AME also offers cylinders from 10 ton through 250 ton mining jacks and the cribbing to safely lift all sizes of equipment.

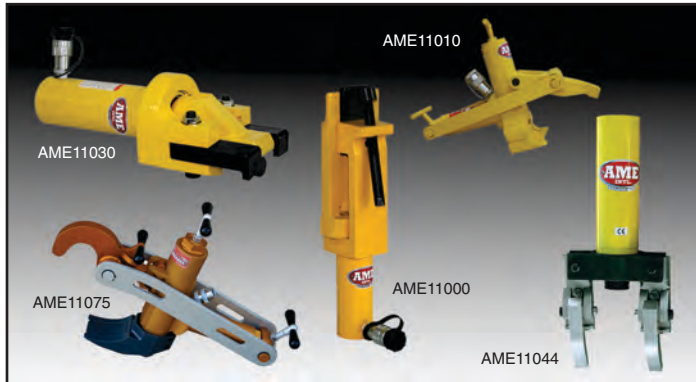

AME BEAD BREAKERS

Cat. No.	Description	Works on Wheel Sizes	Weight lbs. / kg
*AME11010	COMBI TIRE BEAD BREAKER	Single, 2 & 3 Piece up to 25"	34 / 15.42
*AME11000	OTR GIANT TIRE BEAD BREAKER	5 Piece Wheels 25" - 51"	33 / 14.96
*AME11075	DIAMONDBACK ALUMINUM BEAD BREAKER	3 Piece Wheels 25" & Larger	34 / 15.42
*AME11030	OTR 2000 GIANT TIRE BEAD BREAKER with 6" stroke	5 Piece Wheels 39" - 63"	52 / 23.58
*AME11044	OTR 3000 GIANT TIRE BEAD BREAKER with Universal Jaws Kit	5 Piece Wheels 51" - 63"	54 / 24.49

*Denotes special item



AME HYDRAULIC RAMS

Cat. No.	Description	Stroke in. / mm	Retracted Height in. / mm	Weight lbs. / kg
*AME13010	10 TON HYDRAULIC CYLINDER	2 1/8 / 53.98	4 3/4 / 120.65	6 / 2.72
*AME13030	10 TON HYDRAULIC CYLINDER	6 1/8 / 155.75	9 3/4 / 247.65	11 / 4.98
*AME13050	10 TON HYDRAULIC CYLINDER	10 1/8 / 257.17	13 3/4 / 349.25	14 / 6.35
*AME13060	30 TON HYDRAULIC CYLINDER	2 7/16 / 61.91	4 5/8 / 117.47	15 / 6.80
*AME13070	10 TON LOW PROFILE CYLINDER KIT, with 1", 2" & 3" Extensions	1 / 25	3.5 / 90	10 / 4.53
*AME13100	25 TON CYLINDER	6 3/4 / 158.75	10 3/4 / 273.05	23 / 10.43

*Denotes special item



HYDRAULIC PUMPS, HOSE & COUPLERS

Cat. No.	Description	Weight lbs. / kg
*AME15000	3.5 QT. TURBO II AIR HYDRAULIC PUMP 10,000 PSI / 700 Bar	16 / 7.25
*AME15920	5 QT. AIR HYDRAULIC PUMP w/ STEEL RESERVOIR, 10,000 PSI / 700 Bar	23 / 10.43
*AME16040	8', 2.5m HYDRAULIC HOSE w/ 16050 HOSE HALF COUPLER, 10,000 PSI / 700 Bar	6 / 2.72
*AME16050	HIGH FLOW HOSE HALF COUPLER 3/8" NPT 10,000 PSI / 700 Bar	1 / .045

*Denotes special item



LIFTING AND CRIBBING

Cat. No.	Description	Min. Height in. / mm	Max Height in. / mm	Weight lbs. / kg
*AME13121	55 TON ALUMINUM JACK 6" Stroke w/Saddle & Base	11 3/4 / 298	17 3/4 / 451	32 / 14.51
*AME13000	100 TON ALUMINUM JACK 6" Stroke	11 3/4 / 298	17 3/4 / 451	53 / 24.04
*AME15002	STEEL CRIBBING SET 3", 6", 9"	3 / 76.2	18 / 457	141 / 63.95
*AME15230	INDUSTRIAL CRIBBING BLOCK, 6"x7"x24" Black	6 / 152	7 / 178	26 / 11.79
*AME15260	12 PIECE INDUSTRIAL CRIBBING SET (15230)	6 / 152	24 / 610	312 / 141.52
*AME14465	TITAN JACK PLATE w/NON SKID SURFACE, 12"x12"x1.5"	1.5 / 38	1.5 / 38	8 / 3.62

*Denotes special item

KEN-TOOL

Tire & Rim Service Products



TUBELESS TRUCK MOUNT/DEMOUNT IRONS

Cat. No.	Model	Length in. / cm	Diameter in. / mm	Weight lbs. / kg
KEN34645	T45A	37 / 94	3/4 / 20	4.6 / 2.1
KEN34645C	T45AC (classic)	37 / 94	3/4 / 20	4.6 / 2.1
KEN34644	T45A-2000K	37 / 94	3/4 / 20	5 / 2.2
KEN34647	T45HD	41 / 104	7/8 / 22	7 / 3.2
KEN34747	T46A	36 / 91cm	3/4 / 20	4.5 / 2
KEN34748	T46B	36 / 91cm	3/4 / 20	4.5 / 2
KEN34749	T46C	22 / 56	3/4 / 20	3 / 1.4
KEN34847	T47A	52 / 132	1 / 25	11 / 5
KEN34848	T47B	49.5 / 126	1 / 25	11 / 5
*KEN34849	T47C	27 / 69	1 / 25	6.6 / 3



TIRE MOUNT/DEMOUNT SPOONS

STRAIGHT SPOONS

Cat. No.	Model	Length in. / cm	Diameter in. / mm	Weight lbs. / kg
KEN32101	T1X	18 / 46	11/16 / 18	1.8 / 8
KEN32119	T19	24 / 61	11/16 / 18	2.5 / 1.1
KEN33219	T19A	30 / 61	11/16 / 18	3 / 1.4
*KEN33238	T38	30 / 61	7/8 / 22	4.8 / 2.2

DROP-CENTER SPOONS

Cat. No.	Model	Length in. / cm	Diameter in. / mm	Weight lbs. / kg
KEN32121	T21R	18 / 46	11/16 / 18	1.8 / 8
*KEN34121	T21F	24 / 61	11/16 / 18	2.5 / 1.1
*KEN34122	T21HD	30 / 76	7/8 / 22	4.5 / 2

CURVED SPOONS

Cat. No.	Model	Length in. / cm	Diameter in. / mm	Weight lbs. / kg
KEN32102	T2X	18 / 46	11/16 / 18	1.8 / 8
KEN32120	T20	24 / 61	11/16 / 18	2.5 / 1.1
KEN33220	T20A	30 / 76	11/16 / 18	3 / 1.4
KEN33239	T39	30 / 76	7/8 / 22	4.5 / 2



BLUE COBRA AND 19.5" TIRE MOUNT/DEMOUNT TOOLS

Cat. No.	Model	Length in. / mm	Weight lbs. / kg
KEN35440	BLUE COBRA	54 /	22 / 10
*KEN33199	19.5 TIRE IRONS (SET OF 2)	38 /	7 / 3.2
*KEN33196	19.5 BEAD HOLDER for Aluminum Wheels		
*KEN31710	BRASS BEAD HOLDER for Steel Wheels		
KEN31810	LEATHER WHEEL PROTECTOR		
KEN33195	19.5 TOOL SET, includes: KEN33199, KEN33196, KEN31710, KEN31810		



DUCK-BILLED BEAD BREAKING WEDGES

WOOD HANDLED

Cat. No.	Model	Handle No.	Length in. / cm	Weight lbs. / kg
KEN35327	T11D	KEN35127	17 / 43	4.8 / 2.2
KEN35329	T11E	KEN35129	30 / 76	11 / 5

FIBERGLASS HANDLED

Cat. No.	Model	Handle No.	Length in. / cm	Weight lbs. / kg
KEN35427	TG11D	KEN35227	18 / 46	4.8 / 2.2
KEN35429	TG11E	KEN35229	32 / 81	11 / 5

*DENOTES SPECIAL ORDER ITEM

KEN-TOOL

Tire & Rim Service Products



HEAVY DUTY TIRE HAMMERS

WOOD HANDLED

Cat. No.	Model	Handle No.	Diameter in. / cm	Weight lbs. / kg
KEN35321	T34	KEN35119	17 / 43	5.4 / 2.4
KEN35323	T35	KEN35119	16.5 / 42	6.1 / 2.7
KEN35325	T36	KEN35119	16.5 / 42	5.3 / 2.4

FIBERGLASS HANDLED

Cat. No.	Model	Handle No.	Diameter in. / cm	Weight lbs. / kg
*KEN35421	TG34	KEN35219	18 / 46	6.1 / 2.7
KEN35423	TG35	KEN35219	18 / 46	6.6 / 3
KEN35425	TG36	KEN35219	18 / 46	6.1 / 2.7

REPLACEMENT RUBBER HEAD

Cat. No.	Model	Description
KEN35104	T11RH	RUBBER HEAD for T11R, TG11R, T33R, TG33R
KEN35105	T34R	RUBBER HEAD for T34, TG34, T35, TG35, T36, TG36

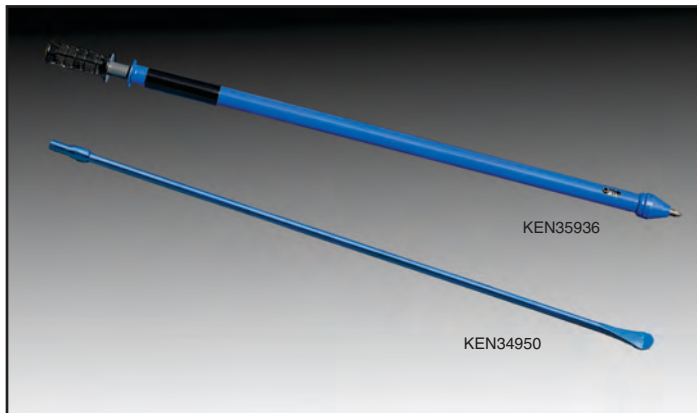

IMPACT BEAD BREAKER, VALVE BREAKER & IRON MAN LIFTING BAR

Cat. No.	Model	Description	Length in. / cm	Weight lbs. / kg
KEN35924	T24B	ECONOMY BEAD BREAKER	46 / 117	13.5 / 6.1
KEN35926	T26B	HEAVY-DUTY BEAD BREAKER	50 / 127	23 / 10.4
KEN35936	T36B	VALVE BREAKER	45 / 115	16 / 7.3
KEN34950	T950	IRON MAN WHEEL LIFTING BAR	58 / 147	10 / 4.5

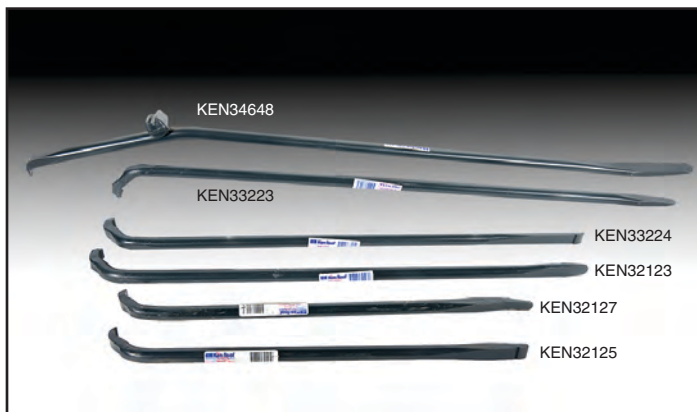

LOCK RING TOOLS

Cat. No.	Model	Description	Length in. / cm	Weight lbs. / kg
KEN32123	T23	TRUCK LOCK RING REMOVER	24 / 61	2.4 / 1
KEN33223	T23A	TRUCK LOCK RING TOOL	30 / 76	3.1 / 1.4
KEN33224	T23B	COMBINATION RIM/RING TOOL	23.5 / 60	2.4 / 1
KEN32125	T25	RIM LOCK TOOL	18 / 46	1.8 / 8
KEN32127	T27	SPECIAL LOCK RING TOOL	18 / 46	1.8 / 8
KEN32128	T28	LOCK RING TOOL	18 / 46	1.8 / 8
KEN34648	T48A	HEAVY-DUTY LOCK RING TOOL	37 / 94	4.6 / 2.1

*DENOTES SPECIAL ORDER ITEM

KEN-TOOL

Tire & Rim Service Products



KEN32109

SMALL TIRE MOUNT/DEMOUNT IRONS

Used in pairs to mount/demount passenger, motorcycle, industrial, ATV and other small tires.

Cat. No.	Model	Length in. / cm	Diameter in. / mm	Weight lbs. / kg
KEN39805	T43A	15 / 38	3/4 / 20	1.8 / 8
KEN32106	T6A	16.5 / 42	5/8 / 16	1.5 / 7
KEN32109	T9A	9 / 23	7/16 / 11	4 / 16
*KEN32116	T16A	16 / 41	7/16 / 11	7 / 3



KEN36002

KEN36001

TIRE INFLATION CAGES

PORTABLE 2-BAR CAGE

Cat. No.	Model	Height in. / cm	Width in. / cm	Base in. cm	Weight lbs. / kg
KEN36001	T101	41 / 104	16 / 41	7 x 21.5 18 x 55	60 / 27.2
*KEN36007	T101A	43.5 / 111	20.5 / 52	7 x 21.5 18 x 69	72 / 32.6

4-BAR CAGE

Cat. No.	Model	Height in. / cm	Width in. / cm	Base in. cm	Weight lbs. / kg
KEN36002	T102	43.5 / 111	20.5 / 52	31.5 x 26 80 x 66	146 / 66.2

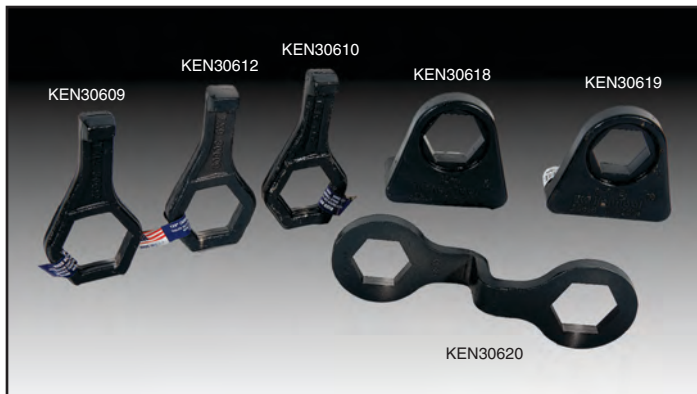

CAP NUT WRENCHES

Cat. No.	Model	Description	Size in. / cm	Weight lbs. / kg
KEN30609	TX9	SAE PORKCHOP™ CAP NUT WRENCH	1½ / 41	.73 / .3
*KEN30610	TX10	METRIC PORKCHOP™ CAP NUT WRENCH	/ 35	.4 / .1
KEN30612	TX12	METRIC PORKCHOP™ CAP NUT WRENCH	1½ / 41	.4 / .1
KEN30620	TX50	COMBINATION SAE & METRIC	1½ / 41	1.3 / .6
KEN30618	TX200	SAE HEAVY DUTY CAP NUT WRENCH	1½ / 41	2.6 / 1.2
KEN30619	TX241	METRIC HEAVY DUTY CAP NUT WRENCH	1½ / 41	2.6 / 1.2



BEAD-BREAKING TOOLS FOR TRUCK, FARM AND OTR

Cat. No.	Model	Description	Length in. / cm	Weight lbs. / kg
KEN33341	T41	SWAN NECK LEVERAGE BAR	30 / 76	5.3 / 2.4
KEN33342	T42	30" BEAD BREAKER	30 / 76	4.8 / 2.2
KEN34652	T52	BEAD BREAKER LEVERAGE BAR	33 / 84	5.5 / 2.5
KEN32126	T26A	BEAD-BREAKING TOOL/ DRIVING IRON	11¾ / 32	4.4 / 2

*DENOTES SPECIAL ORDER ITEM

KEN-TOOL

Tire & Rim Service Products



TIRE STANDS

Cat. No.	Model	Description	Weight lbs. / kg
KEN36015	T115	TRUCK TIRE CHANGING STAND	21 / 9.5
*KEN36016		EASY-LIFT BEAD SEATING STAND for 8-3/4" diameter hubs	36 / 16.4
*KEN36017		EASY-LIFT BEAD SEATING STAND for 11" diameter hubs	37 / 16.8

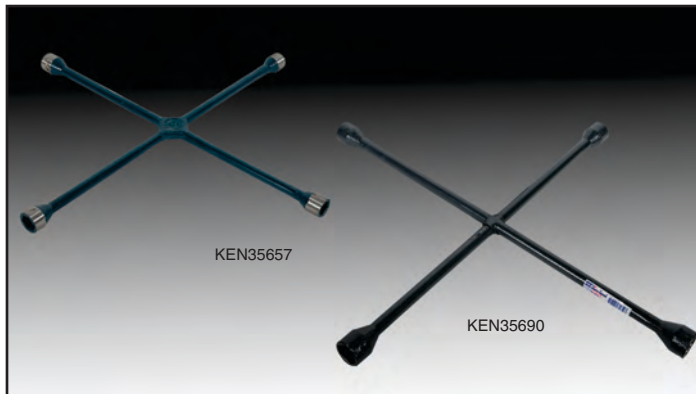

PASSENGER/ LIGHT TRUCK FOUR-WAY LUG WRENCHES

Cat. No.	Model	Socket Sizes	Length in. / cm	Weight lbs. / kg
*KEN35656	T56	17, 19, 21, 22mm	20 / 51	4 / 1.8
KEN35657	T57	3/4", 13/16", 7/8", 15/16"	23 / 58	4.5 / 2
KEN35659	T59	3/4", 13/16", 7/8", 15/16"	22 / 56	4.2 / 1.9
KEN35690	T90	LT 7/8" DW, 15/16", 1", 1 1/16"	25 / 64	7.2 / 3.2



ECONOMY FOUR-WAY LUG WRENCHES

Cat. No.	Model	Socket Sizes	Length in. / cm	Weight lbs. / kg
*KEN35620	T950	3/4", 13/16", 7/8", 17mm	20 / 51	3.41 / 1.5
*KEN35662	T62	3/4", 13/16", 7/8", 17mm	18 / 46	3.2 / 1.5
KEN35663	T63	17mm, 19mm, 21mm, 22mm	18 / 46	3.2 / 1.5
*KEN35630		17mm, 19mm (3/4"), 21mm (13/16"), 23mm (7/8")	20 / 51	3.7 / 1.7
*KEN35635		17mm, 19mm (3/4"), 21mm (13/16"), 23mm (7/8")	14 / 36	2.6 / 1.2



HEAVY-DUTY TRUCK LUG WRENCHES

Cat. No.	Model	Socket Sizes	Length in. / cm	Weight lbs. / kg
KEN35695	T95	1 1/16", 1 1/4", 1 1/2", 1 3/16" sq.	27.5 / 70	13.8 / 6.2
*KEN35795	TM95	24mm, 27mm, 30mm, 33mm	27.5", 70	13.5 / 6.1
KEN35595	TC95	1 1/2", 13/16sq., 30mm, 33mm	27.5", 70	14.2 / 6.4
KEN35697	T95A	1 1/4", 1 1/2", 1 3/16" sq., 3/4" SERVICE ARM	27.5 / 70	13.5 / 6.1
*KEN34401	TR10	1 3/4" HEX, 1 5/16" sq.	29.5", 75	12.2 / 5.5
*KEN34402	TR11	HANDLE FOR KEN34401	30", 76	6.5 / 2.9

*DENOTES SPECIAL ORDER ITEM

GAITHER Tire Inflation Products



Gaither's Bead Booster® is designed to assist in the inflation of tubeless tires by setting the bead with a quick release of air pressure. Gaither's Bead Bazooka™ combines the most powerful Automatic Rapid Air Release System and easiest-to-handle tank for seating tubeless tire beads.



TECH BOOSTER

ASME & CE certified—5 gallon tank with manual release. Powder coated inside and out.

Cat. No.	Description
GB-5Z	TECH BOOSTER
G12912	MANUAL RELEASE VALVE
G12913	DOUBLE BARREL WITH LOCK NUT
G12914	PRESSURE GAUGE
G12916	INTAKE VALVE
G12917	SAFETY POP-OFF VALVE



TECH AUTO BOOSTER

ASME & CE certified—5 gallon tank with push button release. Powder coated inside and out.

Cat. No.	Description
GB-5ZA	TECH AUTO BOOSTER
G12912A	AUTO RELEASE VALVE
G12913	DOUBLE BARREL WITH LOCK NUT
G12914	PRESSURE GAUGE
G12916	INTAKE VALVE
G12917	SAFETY POP-OFF VALVE
GAVTK	BEAD SEATER UPGRADE KIT
*GAIG12925	SWITCH VALVE
*GAIG12923	NYLON HOSE

* Denotes special order item.



BEAD BAZOOKA™ – 6 LITRE

ASME, CE, TUV certified—6 litre tank with Rapid Air Release System. Powder coated inside and out.

Cat. No.	Description
GBB6L	BEAD BAZOOKA™
G12913B	SLOTTED DOUBLE BARREL WITH LOCK NUT
G12914B	PRESSURE GAUGE
G12915B	Y CONNECTION
G12916B	INTAKE VALVE
G12917B	SAFETY VALVE
G12919B	SWITCH VALVE
GGB-55	WALL CLIP



BEAD BAZOOKA™ – XL 9 LITRE

ASME, CE, TUV certified—9 litre tank with Rapid Air Release System. Powder coated inside and out.

Cat. No.	Description
GBB9L	BEAD BAZOOKA™ XL
G12913B	SLOTTED DOUBLE BARREL WITH LOCK NUT
G12914B	PRESSURE GAUGE
G12915B	Y CONNECTION
G12916B	INTAKE VALVE
G12917B	SAFETY VALVE
G12919B	SWITCH VALVE

GAITHER Tire Changing Products



GAITHER TOOL-J1™

The J1 is a 2 piece system that mounts and dismounts all standard 19.5", 22.5" and 24.5" tubeless tires up to a 315/80R22.5, including those mounted on aluminum wheels without having to lift tire/wheel assembly.

Cat. No.	Description
J1	GAITHER TOOL-J1™

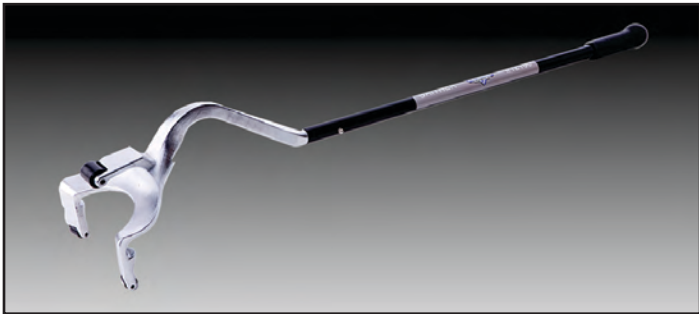

PLATINUM DEMOUNT TOOL

The Demounting Tool is a one piece tool that dismounts all standard 22.5" and 24.5" tubeless tires without having to lift the tire/wheel assembly. Includes Gaither's Handle Protector.

Cat. No.	Description
G12100	PLATINUM DEMOUNT TOOL
*GAI12100-1	HANDLE GRIP
G12100-7	LARGE ROLLER
G12100-8	PIN

* Denotes special order item.

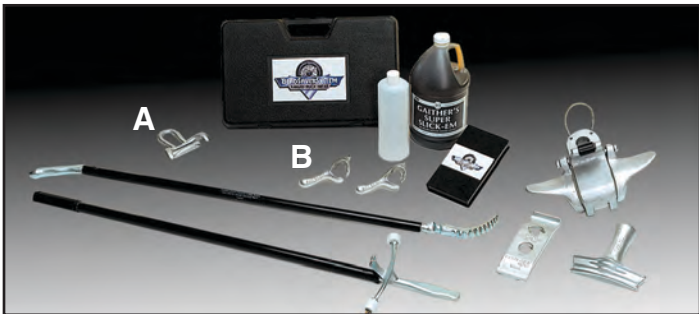

BEAD SAVER SYSTEM®

The Bead Saver System mounts and dismounts all tubeless truck tires from 17.5" up to 24.5", including all super singles.

Cat. No.	Description
*GAI12880	BEAD SAVER SYSTEM®
*GAI12880E	BEAD SAVER DELUXE SYSTEM® Clevis Asst (A) and Extra Beadkeeper (B) included with Deluxe "E" Kit

* Denotes special order item.



RUBBERHEAD®

Gaither's Beadkeeper is the original tool for assisting in the mounting process. Coated for protecting aluminum wheels from scratches. The blue Wide Mouth Rubberhead is available for wheels with larger flanges.

Cat. No.	Description
G12894-C	RUBBERHEAD
*GAI12894-CW	WIDE MOUTH RUBBERHEAD

* Denotes special order item.

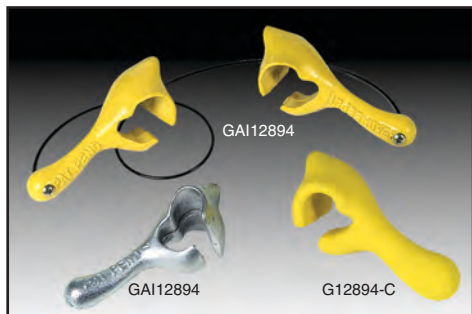

BEADKEEPER®

Gaither's Beadkeeper is the original tool for assisting in the mounting process. Made of drop-forged-steel.

Cat. No.	Description
*GAI12894	BEADKEEPER
G12894P	KEEPERS-ON-A-ROPE—pair connected by nylon rope

* Denotes special order item.

WINNTEC Bottle Jacks



BOTTLE JACKS

All models have a chrome main ram and a chrome pump piston. The extension screws have a pressed thread. These units can be used horizontally and vertically.

Cat. No.	Description
*GAIG411500	15 Ton Bottle Jack 250/9.84 490/19.29
G412000	20 Ton Bottle Jack 242/9.53 472/18.58
G412001	20 Ton Short Bottle Jack 168/6.61 285/11.22
*GAIG413000	30 Ton Bottle Jack 242/9.53 467/18.39

* Denotes special order item.

WINNTEC Pneumatic Jacks



PNEUMATIC JACKS

20 tons. This unit includes a welded base to prolong service. Chrome main ram and aluminum air motor guarantee optimum lifetime. Air filter and air regulator connected to hose are standard. G432003 comes on a cart.

Cat. No.	Description	Min. Ht. mm/in.	Max Ht. mm/in.
G432020	20 TON AIR/HYD. BOTTLE JACK	245/10	470/18.5

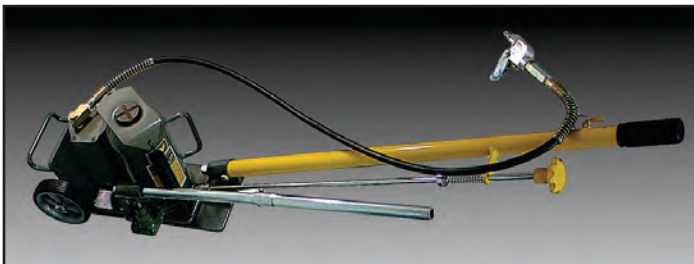

PNEUMATIC JACKS

Cat. No.	Description	Min. Ht. mm/in.	Max Ht. mm/in.
G432003	20 TON AIR/HYD. BOTTLE JACK ON CART	255/10.04	480/18.90

GAITHER Lifting Products



AIR SERVICE JACK

The perfect lifting choice for an extensive range of large vehicles. It carries a very wide hydraulic cylinder and three heavy duty wide adapters to give it stability when lifting loads that tend to shift. Extensively tested, certified and includes official recommendation for carrying out up to a minimum of 30,000 lifts without fail. Built in water separator. 3-year warranty.

Cat. No.	Description	Min. Ht. mm/in.	Max Ht. mm/in.
*GAIGT-3531	35 TON AIR SERVICE JACK	185/7.3	424/16.7

* Denotes special order item.

WINNTEC Floor Jacks & Jack Stands



FLOOR JACK

All stands have a heavy duty robot welded frame, and multiposition ductile ratchet bar.
451205—12 ton sturdy, welded construction. Nylon wheels and removable handle. Delivered per pair.

Cat. No.	Description	Min. Ht. mm/in.	Max Ht. mm/in.
G420300	3 TON DOUBLE PISTON GARAGE JACK	105.4/4.15	490.2/19.30
G420302	3 TON ECONOMY FLOOR JACK	130/5.12	490/19.29
G420300-25	POWER UNIT ASSEMBLY		

FLOOR JACK

2.5 Tons. This ultra low garage jack is equipped with a rubber saddle and handle bumper. Includes Gaither's handle protector.

Cat. No.	Description	Min. Ht. mm/in.	Max Ht. mm/in.
G422500	2.5 TON LOW PROFILE GARAGE JACK	85/3.35	465/18.31

HANDLE PROTECTOR

Protects your vehicle from unnecessary damage. Fits multiple jack manufacturers handles and popular tire tools.

Cat. No.	Description
*GAIGHP-01	BLACK HANDLE PROTECTOR
*GAIGHP-01Y	YELLOW HANDLE PROTECTOR
GHP-01R	RED HANDLE PROTECTOR

* Denotes special order item.

JACK STANDS

All stands have a heavy duty robot welded frame, and multiposition ductile ratchet bar.

451205—12 ton sturdy, welded construction. Nylon wheels and removable handle. Delivered per pair.

Cat. No.	Description	Min. Ht. mm/in.	Max Ht. mm/in.
*GAIG450301	3 TON JACK STANDS	268/10.55	425/16.73
*GAIG451600	6 TON JACK STANDS	394/15.51	597/23.50
*GAI451205	12 TON JACK STANDS WITH WHEELS	300/11.8	460/18

* Denotes special order item.

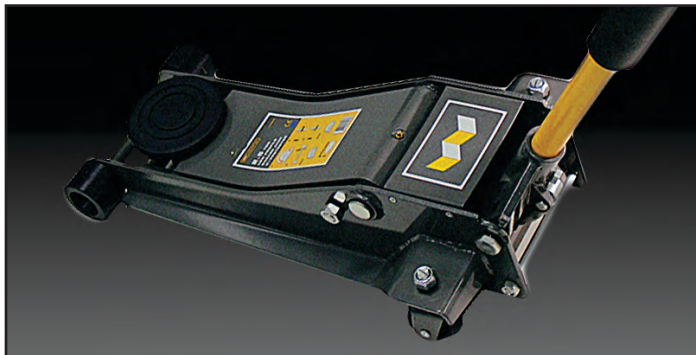

GAITHER Bead Breaking Products



SLIDE HAMMER

Protect your expensive wheels from swinging hammers by breaking the bead loose with Gaither's Slide Hammer. Includes Gaither's handle protector.

Cat. No.	Description
G12026B	SLIDE HAMMER



PNEUMATIC BEAD BREAKER

- For agricultural, ATV, passenger and truck tires
- Light weight, only 17 lbs.
- Includes blow case for storage

Cat. No.	Description
*GAIGTABB-01	PNEUMATIC BEAD BREAKER

* Denotes special order item

NON-FLAMMABLE!



SUPER SLICK 'EM™

Super Slick 'Em™ is a special non-water based lubricant that penetrates and aids in breaking the tire bead from the wheel. **Non-flammable.**

Cat. No.	Description
*GAI12904	SUPER SLICK 'EM™

* Denotes special order item

WINNTEC Specialty Items



O-LINE-ER

Makes it easy to line up wheel studs with holes in rim for easy installation, resulting in decreased installation time and reduced risk of injury from struggling with heavy tires and rims.

Cat. No.	Description
*GAIGTO-01TB	O-LINE-ER

* Denotes special order item



Passenger Car & Light Truck Clip-on Wheel Weights

Since 1939, Perfect Equipment has been a leader in innovation and quality, offering a comprehensive range of wheel balance weights including traditional, non-lead, knock-on and adhesive options. Perfect Equipment is a part of the WEGMANN automotive global wheel weight platform that supplies both OEM and aftermarket customers worldwide. The company is recognized for the broadest product offerings and the highest quality standings in the industry and has become a reputable name synonymous with quality, performance and fit.



LEAD FINISH

ZINC FINISH

STEEL FINISH

PERFECT WHEEL WEIGHTS PART NUMBER - DESCRIPTION - WEIGHT RANGE (when ordering, replace X.XX with required weight)				
SERIES	RIM PROFILE	LEAD	ZINC	STEEL
P		P - X.XX 0.25 oz. to 3 oz. / 50 per box 3.25 oz. to 6 oz. / 25 per box	PZU - X.XX 0.25 oz. to 3 oz. 50 per box	PST - X.XX 0.25 oz. to 3 oz. 50 per box
AW		AWN - X.XX 0.25 oz. to 3 oz. 25 per box	AWZ - X.XX 0.25 oz. to 3 oz. 25 per box	AWST - X.XX 0.25 oz. to 3 oz. 25 per box
MC		MCN - X.XX 0.25 oz. to 4 oz. 25 per box	MCZ - X.XX 0.25 oz. to 3 oz. 25 per box	MCST - X.XX 0.25 oz. to 3 oz. 25 per box
LH		H - X.XX 0.25 oz. to 3 oz. 25 per box	LHZ - X.XX 0.25 oz. to 3 oz. 25 per box	LHST - X.XX 0.25 oz. to 3 oz. 25 per box
IAW		IAW - X.XX 5 g to 60 g 25 per box	IAWZ - X.XX 5 g to 60 g 25 per box	IAWST - X.XX 5 g to 60 g 25 per box
EN		EN - X.XX 10 g to 60 g 25 per box	ENZ - X.XX 10 g to 60 g 25 per box	ENST - X.XX 10 g to 60 g 25 per box
FN		FN - X.XX 5 g to 80 g 25 per box	FNZ - X.XX 5 g to 80 g 25 per box	FNST - X.XX 5 g to 60 g 25 per box
TN		TN - X.XX 0.25 oz. to 5 oz. 25 per box	TZ - X.XX 0.25 oz. to 3 oz. 25 per box	TST - X.XX 0.25 oz. to 3 oz. 25 per box







Medium & Heavy Duty Truck Clip-on Wheel Weights



LEAD FINISH



ZINC FINISH

PERFECT WHEEL WEIGHTS PART NUMBER - DESCRIPTION - WEIGHT RANGE <small>(when ordering, replace X.XX with required weight)</small>			
SERIES	RIM PROFILE	LEAD	ZINC
CT		CT – X.XX 2 oz. to 8 oz. / 25 per box 10 to 12 oz. / 20 per box 14 to 16 oz. / 10 per box	n/a
17		17 – X.XX 1 oz. to 8 oz. / 25 per box 10 to 12 oz. / 20 per box 14 to 16 oz. / 10 per box	17Z – X.XX 1 oz. to 6 oz. 25 per box
19		19 – X.XX 2 oz. to 8 oz. / 25 per box 10 to 12 oz. / 20 per box	n/a
LT1		LT1 – X.XX 0.5 oz. to 6 oz. 25 per box	LT1Z – X.XX 0.50 oz. to 6 oz. 25 per box
RC		RC – X.XX 2 oz. to 8 oz. / 25 per box 10 to 12 oz. / 20 per box	n/a
TAL		TAL – X.XX 2 oz. to 8 oz. 25 per box	TALZ – X.XX 1 oz. to 6 oz. 25 per box

WHEEL WEIGHTS, KITS & TOOLS



QUIKSTIK® Adhesive Wheel Weights

Pre-cut and Pre-taped weights – no cutting, no pre-contouring, and no waste. Each segment is stamped with actual weight in ounces and grams.



LEAD ADHESIVE WHEEL WEIGHTS – PASSENGER CAR & MOTORCYCLE APPLICATIONS

Cat. No.	Increments	Width	Size	Profile	Box Qty.
PE100360C (Chrome)	0.25 oz. (7g)	½"	3 oz.	Standard	30
PE100360S (Silver)	0.25 oz. (7g)	½"	3 oz.	Standard	30
PE100360B (Black)	0.25 oz. (7g)	½"	3 oz.	Standard	30
PE100720	0.25 oz. (7g)	½"	3 oz.	Standard	60
PE200624	0.25 oz. (7g)	¾"	3 oz.	Low	52
PE300360	0.5 oz. (14g)	¾"	6 oz.	Standard	30
PECL6	1 oz. (28g)	¾"	6 oz.	Standard	30
PECL12	2 oz. (56g)	1¼"	12 oz.	Standard	8

LEAD ADHESIVE WHEEL WEIGHTS – TRUCK APPLICATIONS

Cat. No.	Increments	Width	Size	Profile	Box Qty.
PE300360	0.5 oz. (14g)	¾"	6 oz.	Standard	30
PECL6	1 oz. (28g)	¾"	6 oz.	Standard	30
PECL12	2 oz. (56g)	1¼"	12 oz.	Standard	8

STEEL ADHESIVE WHEEL WEIGHTS

Cat. No.	Increments	Width	Size	Profile	Box Qty.
PESSG060N	5g	¾"	60g	Low	25
PESST300N	0.25 oz. (7g)	¾"	3 oz.	Standard	25
PE200624ST	0.25 oz. (7g)	½"	3 oz.	Low	52
PESSM600N	0.25 oz. (7g)	1"	6 oz.	Standard	30
PE300360ST	0.5 oz. (14g)	1"	6 oz.	Standard	30

STEEL ADHESIVE WHEEL WEIGHT ROLLS

Cat. No.	Segments	Width	Size	Profile	Box Qty.
PE200624STR	0.25 oz. (7g)	½"	20 lb.	Low	1250
PESSG7500N	5g	¾"	16.5 lb.	Low	1500
PESST32000N	0.25 oz. (7g)	¾"	20 lb.	Standard	1280



QUIKSTIK® STARTER KITS & STANDS

Cat. No.	Description
PEK2000	QUIKSTIK® STARTER KIT with single roll stand
PEK3000	QUIKSTIK® STARTER KIT with dual roll stand
PEQS2000	QUIKSTIK® STAND, holds one steel QuikStik® roll
PEQS3000	QUIKSTIK® DUAL STAND, holds two steel QuikStik® rolls

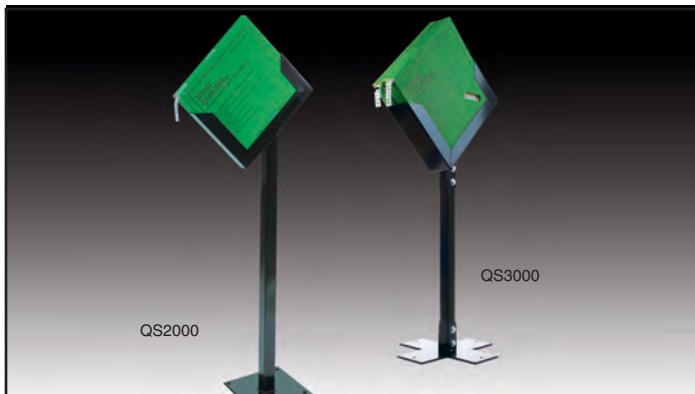

WHEEL WEIGHTS, KITS & TOOLS

Wheel Weight Assortments



LEAD WHEEL WEIGHT ASSORTMENTS

Cat. No.	Description	Total Qty.
PECWW060	COMPREHENSIVE HEAVY DUTY TRUCK ASSORTMENT – 28.5”w x 14”d x 22”h	300
PECWW150	MASTER ASSORTMENT, a practical starting kit 35.75”w x 8.25”d x 39”h	1026
PECWW074	MASTER ASSORTMENT PIECES 36”w x 14.5”d x 67” h	2000
PECWW075	COMPREHENSIVE MASTER ASSORTMENT 36”w x 14.5”d x 67” h	2625



STEEL WHEEL WEIGHT ASSORTMENTS









Cat. No.	Description	Total Qty.
PECWW075ST	NON-LEAD MASTER ASSORTMENT 36”w x 14.5”d x 67” h	2325
PECWW150ST	NON-LEAD TABLE TOP ASSORTMENT 35.75”w x 8.25”d x 39”h	836



ZINC WHEEL WEIGHT ASSORTMENTS

Cat. No.	Description	Total Qty.
PECWW075Z	ZINC MASTER ASSORTMENT 36”w x 14.5”d x 67” h	2325
PECWW150Z	ZINC TABLE TOP ASSORTMENT 36”w x 8.25”d x 38” h	732

Premium Passenger Car & Motorcycle Wheel Weights

ZINC CLIP-ON WEIGHTS FOR PASSENGER CARS				
TYPE	RIM PROFILE	DESCRIPTION	MATERIAL	WEIGHT RANGE
160		One-piece zinc clip-on wheel weight. Universal fit for slim flange steel rims.	Zinc	5g to 60g
161		One-piece zinc clip-on wheel weight. Universal fit for standard flange steel rims.	Zinc	5g to 60g
164		One-piece zinc clip-on wheel weight. Universal fit for wide flange steel rims.	Zinc	5g to 90g
660		One-piece zinc clip-on wheel weight. Ideally suited for European aluminum rims.	Zinc	5g to 60g
661		One-piece zinc clip-on wheel weight. Ideally suited for Japanese aluminum rims.	Zinc	5g to 60g
666		One-piece zinc clip-on wheel weight. Same as Type 660, but with a shorter clip, to better fit rims with a low bead seating area.	Zinc	5g to 60g
274		Type 274 with separate B3 clip, replaces BMZ series. Produced especially for BMW and aluminum rims. BMW steel rims: Type 274 with clip B1 BMW aluminum rims: Type 274 with clip B3	Zinc	5g to 60g
260		Two piece weights with separate clip for steel and aluminum rims applied by almost all German vehicle manufacturers. Weight sizes 5 and 10 g are made of polypropylene (PP). All other sizes are made of premium zinc alloy.	Polypropylene, Zinc	5g to 60g
261		Weight with separate clip especially for Daimler steel and aluminum rims. Daimler steel rims: Weights type 261 combined with clip M1 Daimler aluminum rims: Weights type 261 combined with clip MA	Polypropylene, Zinc	5g to 60g

ZINC ADHESIVE WEIGHTS FOR MOTORCYCLES				
TYPE	RIM PROFILE	DESCRIPTION	MATERIAL	WEIGHT RANGE
799		Dimensions: Varying lengths x 0.43" (width) Total height including adhesive tape: 0.27"	Zinc	5g to 30g

Premium Adhesive Wheel Weights & Wheel Weight Tools



ZINC ADHESIVE WEIGHTS FOR PASSENGER CARS

Type	Description	Weight Range
360	Dimensions: Varying lengths x 0.59" (width) Total height including adhesive tape: 0.23"	5g to 75g
361	Dimensions: Varying lengths x 0.75" (width) Total height including adhesive tape: 0.15"	5g to 60g
380	Dimensions: 6.75" (length) x 0.75" (width) Total height including adhesive tape: 0.16" Available colors: white, silver, chrome, anthracite, black, blue, yellow, orange, red.	60g
390	Dimensions: Varying lengths x 0.59" (width) Total height including adhesive tape: 0.23" Weights of 25 g and higher feature a single segment, weights of 45 g and higher feature two segments.	5g to 60g

HOFMANN WHEEL WEIGHT TOOLS & ACCESSORIES

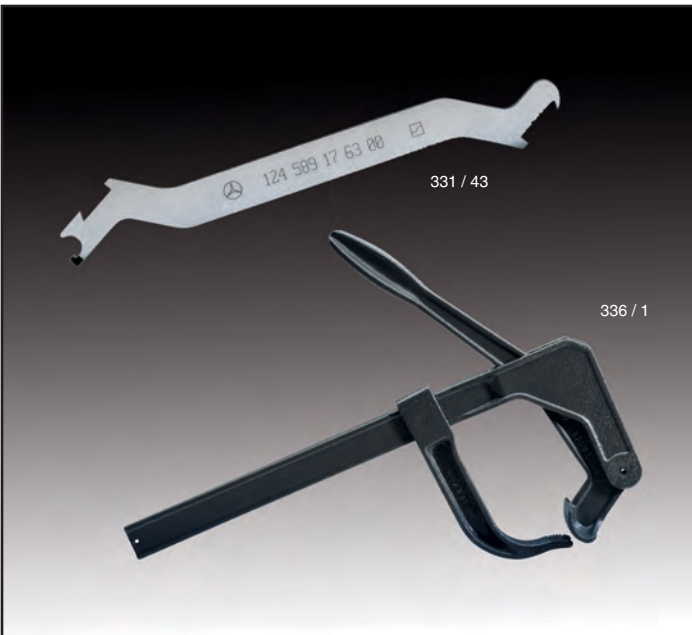

Type	Description	Qty.
Type 331 / 43	CLIP FITTING TOOL – a simple and effective auxiliary tool for the fitting and removal of HOFMANN passenger car weights with separate clip. Opening: 0.61" and 0.75"	1
Type 336 / 1	TIRE COMPRESSION TOOL – For manual bead unseating without auxiliary energy. Allows for safe and quick application of HOFMANN passenger car weights with separate clip. Maximum opening: 13.2"	1

U.W.T. Ultimate Wheel Weight Tools

U.W.T. Tools are the “ultimate tools” for removal and application of all wheel weights. With the U.W.T. design the process of removing wheel weights is now fast, easy and safe. No more struggling, pinching fingers or hands, or scratching rims. U.W.T. tools work off leverage on the weight itself, not the rim. All U.W.T. tools are high quality, made in the USA and economical with replacement parts. Best of all they are simple to use.

U.W.T. WHEEL WEIGHT TOOLS



Cat. No.	Description	Qty.
*UWT1200HP	WHEEL WEIGHT HAMMER & REMOVER WITH HEEL PLATE Comes with replaceable 9000-53 & 9000-73 hooks in the head and UWT1200-1 replaceable cap and 9000-4 replaceable grip. Includes 9000-3 heel plate, used for leverage to remove “clip-only” style weights with no body.	1
UWT2200HP	WHEEL WEIGHT REMOVER WITH HEEL PLATE Heavy duty tool comes with replaceable double 53 & 73 hooks and replaceable 9000-4 grip. Includes 9000-3 heel plate, used for leverage to remove “clip-only” style weights with no body.	1

* Denotes special order item.

U.W.T. REPLACEMENT PARTS

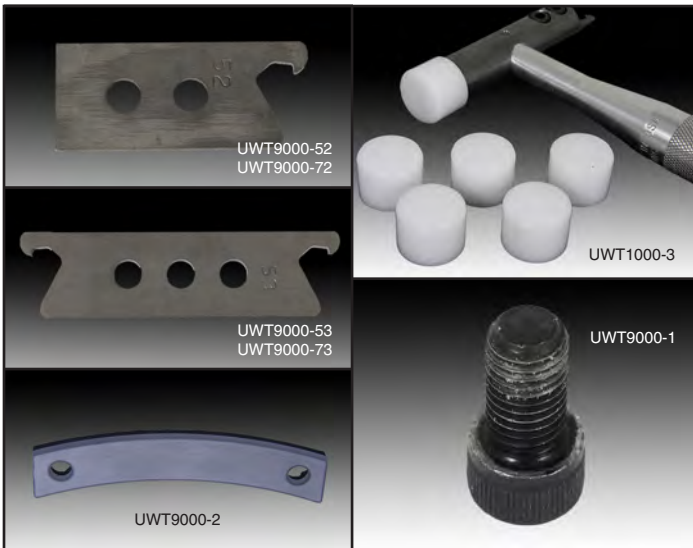

Cat. No.	Description	Qty.
UWT1000-3	REPLACEMENT PROTECTOR CAP for use with UWT1000HP	1
*UWT1200-1	REPLACEMENT PROTECTOR CAP for use with UWT1200HP	1
UWT9000-1	REPLACEMENT SOCKET HEAD CAP SCREW, ¼ - 28 x ½ , for use with UWT1000HP, UWT1200HP, 2000 & 3000	1
UWT9000-2	HEEL PLATE, used with tools for leverage to remove “clip-only” weights with no body	1
UWT9000-4	REPLACEMENT GRIP for use with UWT1000HP, UWT1200HP & UWT2200HP	1
*UWT9000-5	REPLACEMENT SOCKET HEAD CAP SCREW, ¼ - 28 x ¼ , for use with UWT2200HP	1
UWT9000-52	#5 TWO HOLE HOOK, removes most wheel weights, for use with UWT1000HP & UWT1200HP	1
UWT9000-53	#5 THREE HOLE HOOK, removes most wheel weights, for use with UWT2200HP & UWT2000 & 3000	1
UWT9000-72	#7 TWO HOLE HOOK, removes import O.E. weights (with tiny hole) and import after market wheel weights, for use with UWT1200HP	1
UWT9000-73	#7 THREE HOLE HOOK, removes import O.E. weights (with tiny hole) and import after market wheel weights, for use with UWT1000HP, UWT2200HP & UWT2000	1

* Denotes special order item.

TECH WHEEL WEIGHT HAMMERS



Cat. No.	Description
976	SOFT HEAD PASSENGER WHEEL WEIGHT HAMMER for installation/removal of coated wheel weights
977	SOFT HEAD WHEEL WEIGHT HAMMER for installation/removal of coated wheel weights, wood handle
978	PASSENGER WHEEL WEIGHT HAMMER

TECH

Tire Changer Mount/Demount Heads

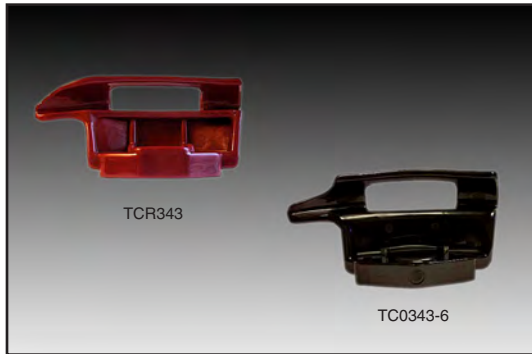

*TMRTC0343-6 NYLON MOUNT AND DEMOUNT HEAD (6 PACK)

O.E.M.	Part Number	Tire Changer
Accuturn	SM102529	220A, All Other Models Require 102765 Adapter
Hunter	RP6 0343B	TC250 • TC300 • TC325 • TC350 TC2000 • TC3250 • TC3500 TC3000 And TC 3100 Series (Require Adapter)
Ranger		Most Models Except R980A, R980E (Some Require Adapters)

*TMRTCR343 RED NYLON MOUNT AND DEMOUNT HEAD (EACH) *TMRTCR343-6 RED NYLON MOUNT AND DEMOUNT HEAD (6 PACK)

O.E.M.	Part Number	Tire Changer
Hunter	221-675-2	TC 250 • TC 300 • TC325
	221-675-2-B	TC250 • TC300 • TC325 • TC350 TC2000 • TC3250 • TC3500 TC3000 And TC 3100 Series (Require Adapter)

*TMRTC183061 NYLON MOUNT / DEMOUNT HEAD KIT WITH TAPERED HOLE

Use With Tapered Shaft 182767 or 182812



O.E.M.	Part Number	Tire Changer
Coats	8183061	5030 • 5040 • 5050 • 5060 • 5065 6050 • 6060 • 6065 • 7050 • 7055 7060 • 7065 • 7655 • 7660 • 7665

*TMRTC182960

Coats	8182960	
Ranger	5150524	For R980A And R980E (Requires 5150523 Mounting Flange)

*TMRTC184432 LOW PROFILE GREY NYLON MOUNT / DEMOUNT HEAD KIT

For Use With Low Profile Tires

O.E.M.	Part Number	Tire Changer
Coats	8184432	5030 • 5040 • 5050 • 5060 • 5065 6050 • 6060 • 6065 • 7050 • 7055 7060 • 7065 • 7655 • 7660 • 7665

*TMRTC250309 NYLON MOUNT / DEMOUNT HEAD KIT WITH ROUND HOLE

Not For Use On Hofmann 1550, 1620 and 1625



O.E.M.	Part Number	Tire Changer
All Tool	G2008401	All Models
Coats	82008402	RC 1 • 5 • 10 • 15 • 20 • Early 5060 9010 • 9024 • APX90
Corghi	250309	All Rim Clamp (Optional Accessory)
Hofmann	2200981	All Earlier Models Except 1550 • 1620 • 1625
Sice	2200981	M39, S40, S41, S42, S43, S45, S408MAXI, S435, S436, S436TC

*TMRTC450310 NYLON MOUNT / DEMOUNT HEAD WITH ROUND HOLE **HEAD ONLY**

For TC 250309 Mount / Demount Head Kit

O.E.M.	Part Number	Tire Changer
All Tool	G3008403	All Models
Coats	83008403	RC 1 • 5 • 10 • 15 • 20 • Early 5060 9010 • 9024 • APX90
Corghi	450310	All Rim Clamp (Optional Accessory)
Giuliano	3008403	Shaft needs to be turned 180° for this Head to work
Hofmann	8314813	All Earlier Models Except 1550 • 1620 • 1625
Hunter	RP11-8314813	Fits All TCX Series (Earlier TCX500 Requires Upgrade Shaft And Adapter Kit RP11-8-114-00091)
Sice	8314813	M39, S40, S41, S42, S43, S45, S408MAXI, S435, S436, S436TOP

*TMRTC14024784 NYLON MOUNT/DEMOUNT HEAD KIT



O.E.M.	Part Number	Tire Changer
Accuturn	14024784	3602 • 3602HP • 4260 • 4560MR • 4602 • 5602 • 5602 HP
Hofmann	4024784	1520 • 1565 • 1620 • 1625 • 1625EM • 3300 • 3300EM Monty 1270, 2300, 3000, 3000GP
John Bean	EAA 0247G20A	EHP System IVE • IV • III • IIE
Snap On	EAA 0247G20A	All Models

*TMRTC20024335 NYLON MOUNT/DEMOUNT HEAD FOR TMRTC14024784 MOUNT / DEMOUNT HEAD KIT **HEAD ONLY**

O.E.M.	Part Number	Tire Changer
Accuturn	20024335	3602 • 3602HP • 4260 • 4560MR • 4602 • 5602 • 5602 HP
Hofmann	24335	1520 • 1565 • 1620 • 1625 • 1625EM • 3300 • 3300EM Monty 1270, 2300, 3000, 3000GP
John Bean	24335	EHP System IVE • IV • III • IIE
Snap On	24335	All Models

*Denotes special order item

TECH Tire Changer Stainless Steel Mount/Demount Heads & Inserts



*TMRTC182788 STAINLESS STEEL MOUNT & DEMOUNT HEAD WITH TAPERED HOLE

O.E.M.	Part Number	Tire Changer
Coats	8182788	5030 • 5040 • 5050 • 5060 • 5065 • 5070 6050 • 6060 • 6065 • 7050 • 7055 7060 • 7065 • 7655 • 7660 • 7665

*TMRTI182961 (2 PK) – TI182963 (12 PK) PLASTIC INSERT FOR TC182788 & TC183429 STAINLESS STEEL MOUNT/DEMOUNT HEADS

O.E.M.	Part Number	Tire Changer
Coats	8182961 (2Pk) 8182963 (12Pk)	RC 1 • 5 • 10 • 15 • 20 • Early 5060 5030 • 5040 • 5050 • 5060 • 5065 • 5070 6050 • 6060 • 6065 • 7050 • 7055 7060 • 7065 • 7655 • 7660 • 7665

*TMRTC101608 PLASTIC INSERT FOR SICAM TIRE CHANGER (5 PK)

O.E.M.	Part Number	Tire Changer
Sicam	SM101608	Accuturn, Bosch, Sicam

*TMRTI254341A PLASTIC INSERTS FOR MOUNT & DEMOUNT HEAD (10 PK) Includes Allen Wrench

O.E.M.	Part Number	Tire Changer
Coats	89209611	RC 1 • 5 • 10 • 20 • 9010 • 9024
Corghi	254341A	2024 • 9220 • 9824

*TMRTI20011064 PLASTIC INSERTS FOR MOUNT AND DEMOUNT HEAD Bulk – Does Not Include Pin

O.E.M.	Part Number	Tire Changer
Accuturn	20011064	3402 • 3450 • 3602 • 4602
Accuturn	24016079	5802HP • 5850HP • 5602

*TMRTI4096-10 HUNTER NOSE INSERTS FROM TI11400096 KIT FOR STEEL MOUNT HEADS (10 PK)

O.E.M.	Part Number	Tire Changer
Hunter		TCX Series

*TMRTI4636-10 HUNTER BACK INSERTS FROM TI11400096 KIT FOR STEEL MOUNT HEADS (10 PK)

O.E.M.	Part Number	Tire Changer
Hunter		TCX Series

*TMRTI11400096 INSERT KIT FOR HUNTER STEEL MOUNTHEADS 10 Pcs Each Of TI4096 and TI4636

O.E.M.	Part Number	Tire Changer
Hunter	RP11-8-11400096	TCX Series

*TMRTC247G15A-10 PLASTIC LONG INSERTS FOR STAINLESS MOUNT & DEMOUNT HEAD (10 PK)

O.E.M.	Part Number	Tire Changer
Hofmann	ST4024181	All Models
Snap-On	EAA0247G15A	All Models

TECH Jaws & Clamping Kits



*TMRTC113125C 3-POSITION EXTENDED X-CLAMP KIT

For Coats X-Models With Adjustable Carriers
External (outside/in) Wheel Clamping 6" - 22" Wheels

Kit Includes:		TC 182250 Position Push Buttons (4 Pc) TC 184126 3 Position X-Clamp (4 Pc)
O.E.M.	Part Number	Tire Changer
Coats	8113125C	50X • 60X • 70X (ONLY Works With Upgraded Carriage System. Does Not Work With 5030, 5040, 5045. Must Use TC182247.)

*TMRTC183604 QUILTED CLAMP SOCK (10 PK)

For Jaws And Coats Rim Clamp Tire Changers

O.E.M.	Part Number	Tire Changer
Coats	8183604	All Tire Changers (Except 9010 and 9024E)

*Denotes special order item

TECH

Tire Changer Products



BEAD LIFT AND COMBO TOOLS

Cat. No.	Description
*TMRCT768	COMBO TOOL, specifically designed to mount and demount tires. Use with TI 30 Demount & TI 55 Mount Booties.
*TMRTI30	LARGE WHITE DEMOUNT BOOTIE PROTECTOR for demount end of CT768/TC66679 Combo Tool
*TMRTC181354	20 BEAD LIFTING TOOL for all rim clamp tire changers
*TMRTI55	SMALL WHITE MOUNT BOOTIE PROTECTOR for mount end of CT768/TC66679 Combo Tool
*TMRCT2505	BEAD LIFT "WAVE" TOOL BAR, specially shaped for difficult tire beads

TIRE SPREADERS & ACCESSORIES

Cat. No.	Description
*TMRWL98063	WORK LAMP FOR TIRE SPREADERS



AIR GAUGES AND LENS COVER

Cat. No.	Description
*TMRAG107518	AIR GAUGE for Coats old style tire changers, bolts on back with clips
O.E.M.	Part Number Tire Changer
Coats	8107518 1010 • 2020 • 2020A
*TMRAG107985	AIR GAUGE for Coats tire changers, flange mount
O.E.M.	Part Number Tire Changer
Coats	8107985 4040 • 4040A • 4040SA • 4050A

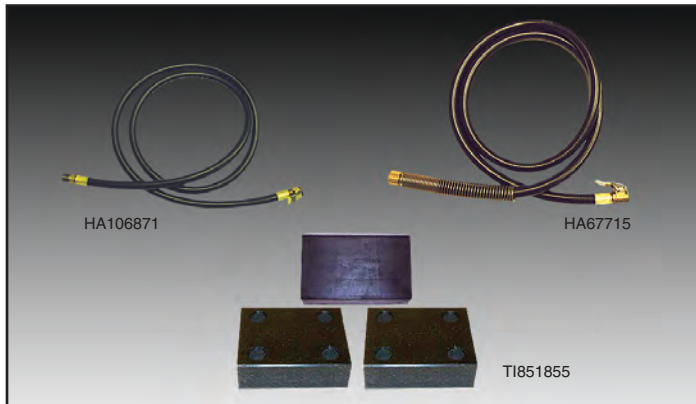

INFLATOR HOSE ASSEMBLIES

Cat. No.	Description
*TMRHA67715	INFLATOR HOSE ASSEMBLY with open end barbed style euro chuck, 52" long. All brass connectors (1/4" I.D. - 19 BSP) hose includes euro chuck.
O.E.M.	Part Number
FMC/John Bean	67715
*TMRHA106871	INFLATOR HOSE ASSEMBLY with open end barbed style euro chuck, 60" long. All brass connectors (1/4" I.D. - 19 BSP) hose includes euro chuck
O.E.M.	Part Number
Coats	106871

RUBBER & NYLON PADS

Cat. No.	Description
*TMRTI851855	LARGE PAD KIT FOR COATS TIRE CHANGERS Kit Includes: 2 - TI181851 and 1 - TI181855



TIRE LUBE SUPPLIES

Cat. No.	Description
*TMRLB106259	LUBE BUCKET FOR TIRE CHANGERS (straight)
O.E.M.	Part Number Tire Changer
Coats	8106259 RC 15 • 20 • 5060 • 5070
*TMRLB106572	LUBE BUCKET FOR TIRE CHANGERS (angled)
O.E.M.	Part Number Tire Changer
Coats	8106572 4040 • 4040SA • 4050
*TMRLB66006	LUBE BUCKET FOR TIRE CHANGERS (straight)
O.E.M.	Part Number
Accuturn	0014466
FMC / John Bean	66006
Hunter	116-35-2

*Denotes special order item

TECH

Wheel Balancer Products



WHEEL BALANCER CONES & SPACER

Cat. No.	Description
*TMRWB720-28 • 36 • 38 • 40	2.95 - 3.63 RANGE
*TMRWB725-28 • 36 • 38 • 40	3.375 - 5.25 RANGE
*TMRWB730-28 • 36 • 38 • 40	3.375 - 5.88 RANGE
*TMRWB735-28 • 36 • 38 • 40	5.03 - 6.88 RANGE
*TMRWB740-28 • 36 • 38 • 40	5.875 - 7.315 RANGE
*TMRWB750-28 • 36 • 38 • 40	SPACER / BACKING PLATE

HAWEKA 40MM / 4MM PITCH PROGRAM NUT KIT

Cat. No.	Description
*TMRWB440	Kit Includes: • Quick Nut • Clamping Hood • Rubber Sleeve • Pressure Ring

WHEEL BALANCER CALIPERS & GAUGE

Cat. No.	Description	Part Number
*TMRWB309011	WHEEL CALIPER measures wheel width ½" and 1" increments (up to 14")	
	O.E.M.	
	Accuturn	525010
	Coats	8309011
	John Bean	061123
	Hunter	221-563-1
	Snap-On	EAA0247G21A

TECH

Brake Lathe Products

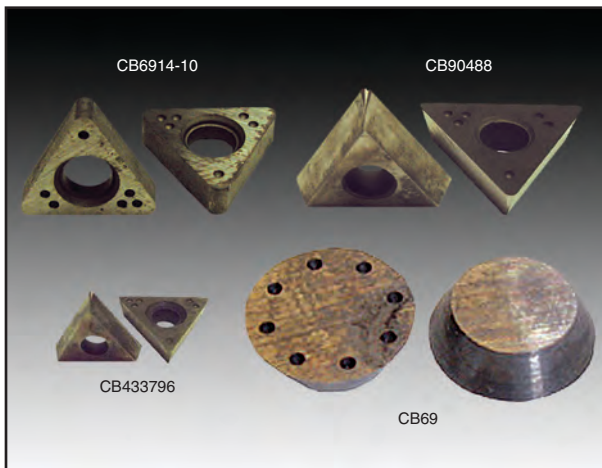

CARBIDE BITS

Cat. No.	Description	Part Number	Brake Lathes
*TMRCB69	ROUND POSITIVE RAKE CARBIDE BIT		
	O.E.M.		
	Ammco	40610	Application based on preference of insert
	Kwikway	109-6900-20	Application based on preference of insert
*TMRCB6914-10	NEGATIVE RAKE CARBIDE BIT .030 RADIUS (10 PK)		
	O.E.M.		
	Ammco	691410	1000 2002 3000 4000 4100 7000 7700 • 40420 • 40430
	FMC/John Bean	90817 (10 Pk)	505 on the Car
	Hunter	221-580-2 (6 Pk)	BL300 BL500 BL505
		221-617-2 (24 Pk)	OCL360 OCL400 OCL430MD
	Kwikway	109-6900-00	Not for use on a Kwikway Lathe. Kwikway Part Number for other brands reference.
*TMRCB90488	POSITIVE RAKE CARBIDE BIT .20 RADIUS 15° ANGLE (10 PK)		
	O.E.M.		
	Ammco	40410	Not for use on Ammco Lathes. Ammco Part Number for other brands reference.
	FMC/John Bean	90488	600 700
	Hofmann	W139 (5 Pk)	Trucut 400 401 on the Car 201 Standard 1115 HD Brake Lathes
*TMRCB433796	POSITIVE RAKE CARBIDE BIT 11° ANGLE • 1/64" RADIUS (10 PK)		
	O.E.M.		
	Accuturn	433796	7700 8910 8911 8922 8944 8989
	Ammco	40435	Not for use on Ammco Lathes. Ammco Part Number for other brands reference.

*Denotes special order item

TECH

Brake Lathe Products

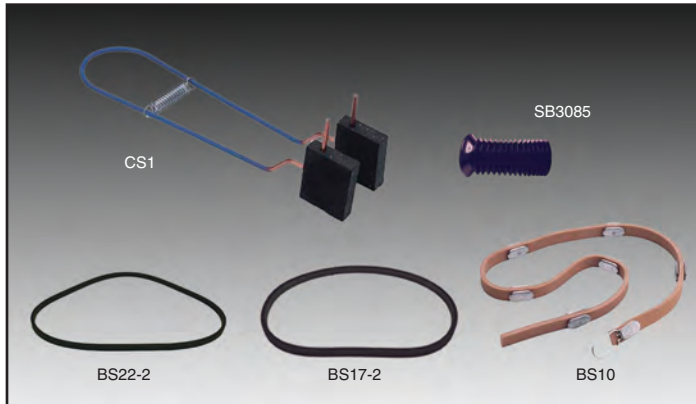

BOOTS & ACCESSORIES

Cat. No.	Description
*TMRSB3085	SPINDLE PROTECTIVE BOOT
O.E.M.	Part Number
Ammco	3085
	Brake Lathe
	3000 • 4000
	4100 • 7700

SILENCERS

Cat. No.	Description
*TMRBS10	ADJUSTABLE VENTILATED ROTOR SILENCER BAND
*TMRBS17-2	SMALL BLACK SOLID ROTOR SILENCER BAND 6-9" Diameter (2 Pack)
*TMRBS22-2	LARGE BLACK SOLID ROTOR SILENCER BAND 10-12" Diameter (2 Pack)
*TMRCS1	CLIP ON SILENCER

TECH

Lift Pads

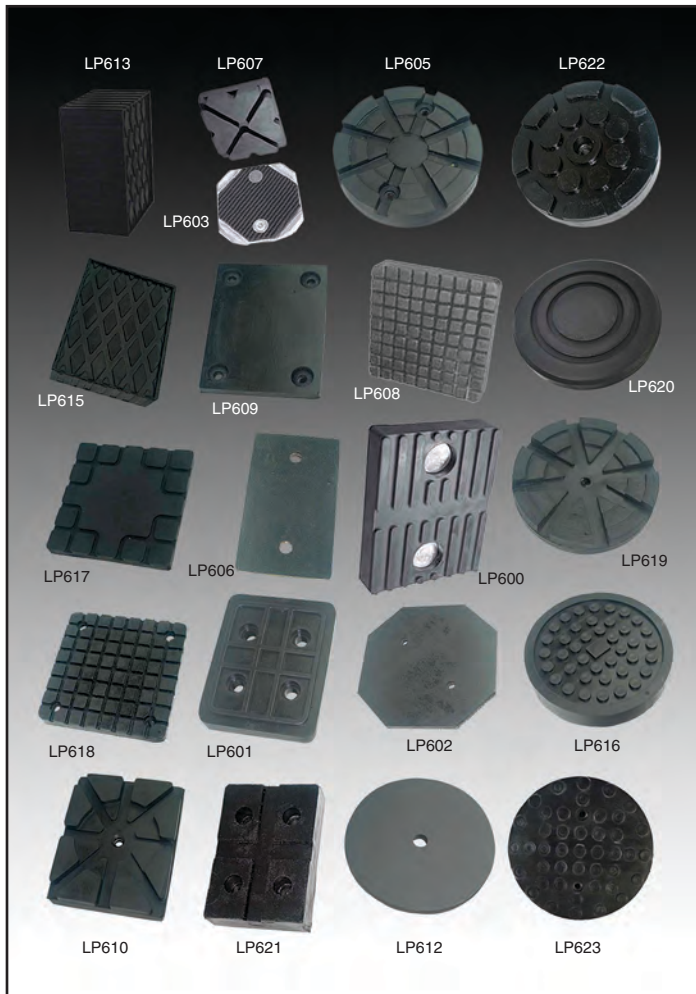

LIFT PADS – 4-PIECE KITS

Cat. No.	Description
*TMRLP600	MOLDED RUBBER PAD for Ammco, Ben Pearson, Challenger & Weaver. 3 $\frac{3}{4}$ " x 5 $\frac{3}{4}$ " x $\frac{3}{4}$ ". 3 $\frac{1}{4}$ " between bolt holes. 4 piece kit.
*TMRLP601	MOLDED RUBBER PAD for Benwil & Bishamon. 4 $\frac{1}{2}$ " x 3 $\frac{5}{8}$ " x $\frac{3}{4}$ ". 1 $\frac{7}{8}$ " (W) between bolt holes. 1 $\frac{5}{8}$ " (L) between bolt holes. 4 piece kit.
*TMRLP602	HEAVY DIE CUT MATERIAL for Challenger. VBM Round. 5 $\frac{7}{8}$ " x 5 $\frac{7}{8}$ " x $\frac{1}{4}$ ". 3" between bolt holes. 4 piece kit.
*TMRLP603	ROUGH HEAVY DIE CUT MATERIAL (8 Sided) for Forward, Eagle, Gemini, Worth & American. Pad only 5" x 5" x $\frac{1}{4}$ ". 3 $\frac{3}{4}$ " between bolt holes. 4 piece kit.
*TMRLP605	MOLDED RUBBER PAD For Nussbaum, Phoenix & Force (old). 5" x 1". 3 $\frac{1}{2}$ " between bolt holes. 4 piece kit.
*TMRLP606	HEAVY DIE CUT for flip up height extensions. Pad only 5 $\frac{1}{2}$ " x 3" x $\frac{1}{4}$ ". 3 $\frac{1}{8}$ " between bolt holes. 4 piece kit.
*TMRLP607	MOLDED RUBBER PAD for Western & American. Slip on, 4 $\frac{1}{2}$ " x 4" x 1". 4 piece kit.
*TMRLP608	BEND PAK SQUARE, SLIP ON, MOLDED RUBBER PAD 5 $\frac{1}{2}$ " x 5 $\frac{1}{2}$ " x 1". 4 piece kit.
*TMRLP609	HEAVY DUTY CUT MATERIAL FOR ROTARY SPO 12 4" x 3 $\frac{1}{4}$ " x $\frac{1}{4}$ ". 3" (W) between bolt holes. 2 $\frac{3}{8}$ " (L) between bolt holes. 4 piece kit.
*TMRLP610	MOLDED RUBBER PAD, SQUARE, for Wheeltronics, Snap-On & Ammco. 5 $\frac{1}{4}$ " x 4 $\frac{1}{2}$ " x 1". 4 piece kit.
*TMRLP612	LIFT PADS, HEAVY DIE CUT MATERIAL, for Globe. 4 $\frac{1}{2}$ " x 3 $\frac{3}{8}$ ". 4 piece kit.
*TMRLP613	SOLID MOLDED RUBBER BLOCK PAD, 6" x 4 $\frac{3}{4}$ " x 3". 4 piece kit.
*TMRLP615	SOLID MOLDED RUBBER BLOCK PAD, 6 $\frac{1}{4}$ " x 4 $\frac{3}{4}$ " x 1 $\frac{1}{2}$ ". 4 piece kit.
*TMRLP616	ALM LIFT PADS MOLDED RUBBER PAD (Like OEM) 6 $\frac{1}{4}$ " x 1 $\frac{1}{8}$ ". 4 piece kit.
*TMRLP617	RUBBER PAD FOR CHALLENGER CL9 & CL10 (Like OEM) 4" x 4" x $\frac{7}{16}$ ". 4 piece kit.
*TMRLP618	BEND PAK SQUARE BOLT-ON MOLDED RUBBER PAD 5 $\frac{1}{2}$ " x 5 $\frac{1}{2}$ " x 1". 3 $\frac{3}{8}$ " (W) between bolt holes. 3 $\frac{5}{8}$ " (L) between bolt holes. 4 piece kit.
*TMRLP619	MOLDED RUBBER PAD for Wheeltronics, Snap-On & Ammco round bolt on. 4.812" x 1.125". 4 piece kit.
*TMRLP620	ROUND RUBBER PAD for Challenger. 5 $\frac{1}{2}$ " x $\frac{3}{4}$ ". 4 piece kit.
*TMRLP621	MOLDED RUBBER PAD for Globe. 3" x 4 $\frac{1}{2}$ " x 1". 2 $\frac{3}{8}$ " (W) between bolt holes. 1 $\frac{5}{8}$ " (L) between bolt holes. 4 piece kit.
*TMRLP622	MOLDED RUBBER PAD for Quality. 4 $\frac{3}{4}$ " round. 4 piece kit.
*TMRLP623	VBM ROUND HEAVY MOLDED MATERIAL for Challenger. $\frac{3}{8}$ " Round. 3" between bolt holes. 4 piece kit.

*Denotes special order item

ADDITIONAL LIFT PADS, UPRIGHTS & EXTENSIONS AVAILABLE.

TECH

Automotive Tire Service



BULGE STYLE ACORN LUG NUTS

Cat. No.	Description	Thread Size	Hex	Height
*TMRT1145	BULGE STYLE ACORN CHROME LUG NUT	7/16"	3/4"	1.38"
*TMRT1146	BULGE STYLE ACORN CHROME LUG NUT	1/2"	3/4"	1.38"
*TMRT1147	BULGE STYLE ACORN CHROME LUG NUT	12mm - 1.25	3/4"	1.38"
*TMRT1148	BULGE STYLE ACORN CHROME LUG NUT	12mm - 1.50	3/4"	1.38"
*TMRT1149	BULGE STYLE ACORN CHROME LUG NUT	14mm - 1.50	3/4"	1.38"
*TMRT1150	BULGE STYLE ACORN CHROME LUG NUT	12mm - 1.75	3/4"	1.38"
*TMRT1310	BULGE STYLE ACORN CHROME LUG NUT	12mm - 1.50	3/4"	1.01"
*TMRT1151	LONG BULGE STYLE ACORN CHROME LUG NUT	1/2"	13/16"	1.75"
*TMRT1152	LONG BULGE STYLE ACORN CHROME LUG NUT	12mm - 1.50	13/16"	1.75"
*TMRT1153	LONG BULGE STYLE ACORN CHROME LUG NUT	12mm - 1.75	13/16"	1.75"
*TMRT1154	LONG BULGE STYLE ACORN CHROME LUG NUT	14mm - 1.50	13/16"	1.75"
*TMRT1155	LONG BULGE STYLE ACORN CHROME LUG NUT	14mm - 2.00	13/16"	1.75"

ELECTRICAL CABLE TIES

Cat. No.	Description	Pkg. Qty.
*TMRBL4	BLACK CABLE TIE 4" 18 lb.	100
*TMRBL6	BLACK CABLE TIE 6" 40 lb.	100
*TMRBL8	BLACK CABLE TIE 8" 50 lb.	100
*TMRBL8-18	BLACK THIN CABLE TIE 8" 18 lb.	100
*TMRBL8W	BLACK WIDE CABLE TIE 8" 120 lb.	100
*TMRBL11	BLACK CABLE TIE 11" 50 lb.	100
*TMRBL14	BLACK CABLE TIE 14" 50 lb.	100
*TMRBL14MT	BLACK MOUNTING CABLE TIE 14" 50 lb.	100
*TMRBL14W	BLACK WIDE CABLE TIE 14" 120 lb.	100
*TMRBL17W	BLACK EXTRA WIDE CABLE TIE 17" 175 lb.	100
*TMRBL24	BLACK EXTRA WIDE CABLE TIE 24" 175 lb.	50
*TMRBL36	BLACK EXTRA WIDE CABLE TIE 36" 175 lb.	50
*TMRBL48	BLACK EXTRA WIDE CABLE TIE 48" 175 lb.	50
*TMRCL4	NATURAL CABLE TIE 4" 18 lb.	100
*TMRCL6	NATURAL CABLE TIE 6" 40 lb.	100
*TMRCL8	NATURAL CABLE TIE 8" 50 lb.	100
*TMRCL11	NATURAL CABLE TIE 11" 50 lb.	100
*TMRCL14	NATURAL CABLE TIE 14" 50 lb.	100
*TMRCL14W	NATURAL WIDE CABLE TIE 14" 120 lb.	100
*TMRCL17W	NATURAL EXTRA WIDE CABLE TIE 17" 175 lb.	100
*TMRCL24	NATURAL CABLE TIE 24" 175 lb.	50
*TMRCL36	NATURAL CABLE TIE 36" 175 lb.	50

SPARE TIRE REMOVAL KIT & KEYS

Cat. No.	Description
*TMRT18435	SPARE TIRE REMOVAL KIT, includes: T18410 - Blue Pin Head T18430 - Green 12mm Square Head T18460 - Black Slotted Square Head T18400 - Red Flat Head T18420 - Yellow Hex Head T18440 - Orange Std. Square Head T18480 - Purple 3/8" Square Head T18470 - Hanging Rack



*Denotes special order item

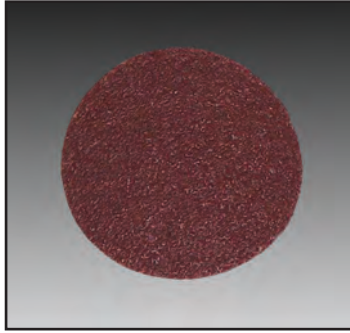

ALUMINUM OXIDE DISC – SANDPAPER

Cat. No.	Description	Pkg. Qty.
*TMRMI215-100	2" ALUMINUM OXIDE DISC - 36 GRIT	100
*TMRMI225-100	2" ALUMINUM OXIDE DISC - 50 GRIT	100
*TMRMI235-100	2" ALUMINUM OXIDE DISC - 80 GRIT	100
*TMRMI245-100	2" ALUMINUM OXIDE DISC - 120 GRIT	100
*TMRMI315-100	3" ALUMINUM OXIDE DISC - 36 GRIT	100
*TMRMI325-100	3" ALUMINUM OXIDE DISC - 50 GRIT	100
*TMRMI335-100	3" ALUMINUM OXIDE DISC - 80 GRIT	100
*TMRMI345-100	3" ALUMINUM OXIDE DISC - 120 GRIT	100

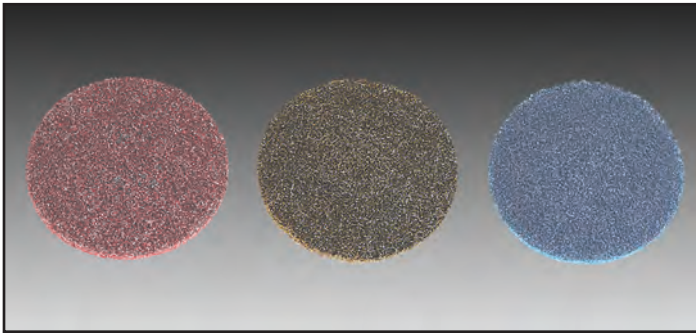

SURFACE CONDITIONING DISCS – RESIN FIBER

Cat. No.	Description	Pkg. Qty.
*TMRMI197-100	2" SURFACE CONDITIONING DISC coarse grit, brown	100
*TMRMI297-100	2" SURFACE CONDITIONING DISC medium grit, maroon	100
*TMRMI397-100	2" SURFACE CONDITIONING DISC fine grit, blue	100
*TMRMI17-100	3" SURFACE CONDITIONING DISC coarse grit, brown	100
*TMRMI27-100	3" SURFACE CONDITIONING DISC medium grit, maroon	100
*TMRMI37-100	3" SURFACE CONDITIONING DISC fine grit, blue	100

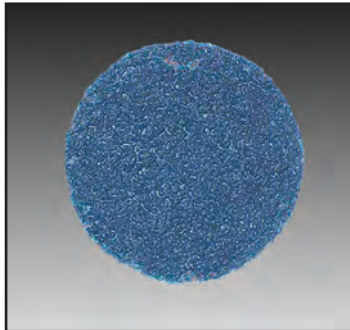

BLUE ZIRCONIA DISCS

Cat. No.	Description	Pkg. Qty.
*TMRMI202-50	2" BLUE ZIRCONIA DISC - 24 GRIT	50
*TMRMI203-50	2" BLUE ZIRCONIA DISC - 36 GRIT	50
*TMRMI204-50	2" BLUE ZIRCONIA DISC - 50 GRIT	50
*TMRMI302-25	3" BLUE ZIRCONIA DISC - 24 GRIT	25
*TMRMI303-25	3" BLUE ZIRCONIA DISC - 36 GRIT	25
*TMRMI304-25	3" BLUE ZIRCONIA DISC - 50 GRIT	25

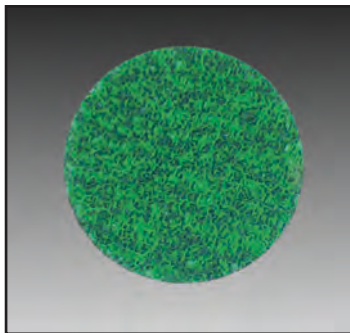

GREEN ZIRCONIA DISCS

Cat. No.	Description	Pkg. Qty.
*TMRMI305-50	2" GREEN ZIRCONIA DISC - 24 GRIT	50
*TMRMI306-50	2" GREEN ZIRCONIA DISC - 36 GRIT	50
*TMRMI307-50	2" GREEN ZIRCONIA DISC - 50 GRIT	50
*TMRMI308-25	3" GREEN ZIRCONIA DISC - 24 GRIT	25
*TMRMI309-25	3" GREEN ZIRCONIA DISC - 36 GRIT	25
*TMRMI310-25	3" GREEN ZIRCONIA DISC - 50 GRIT	25



ARBORS

Cat. No.	Description
*TMRMI20	3" ARBOR ROLOC TYPE HOLDER
*TMRMI200	2" ARBOR ROLOC TYPE HOLDER

*Denotes special order item

Regroovers, Blades & Accessories



TECH REGROOVERS, BLADES & ACCESSORIES

Cat. No.	Description
S145A (110V)	REGROOVER for cutting tread design into repaired tire. Complete with heat adjustable transformer for reliable cutting speed and control, 110 volts.
S145B (220V)	Same as S145A except 220 volts.
BLADES	S145A & S145B REGROOVER BLADES
S145/R-1	ROUND $\frac{5}{64}$ ", 2mm cutting width
S145/R-2	ROUND $\frac{1}{8}$ ", 3mm cutting width
S145/R-3	ROUND $\frac{13}{64}$ ", 5mm cutting width
S145/R-4	ROUND $\frac{9}{32}$ ", 7mm cutting width
S145/R-5	ROUND $\frac{23}{64}$ ", 9mm cutting width
S145/W-1	WIDE $\frac{5}{64}$ ", 2mm cutting width
S145/W-2	WIDE $\frac{5}{32}$ ", 4mm cutting width
S145/W-3	WIDE $\frac{1}{4}$ ", 6mm cutting width
S145/W-4	WIDE $\frac{5}{16}$ ", 8mm cutting width
S145/W-5	WIDE $\frac{13}{32}$ ", 11mm cutting width
S145/W-6	WIDE $\frac{7}{8}$ ", 22mm cutting width

Repair parts available for S145A and S145B.
NOTE: Safety feature, S145 Regroovers are pressure activated.



RILLFIT REGROOVERS, BLADES & ACCESSORIES

Cat. No.	Description
S146A	RILLFIT REGROOVER, 110 volt
S146B	RILLFIT REGROOVER, 220 volt
S146/R-1	ROUND BLADE, $\frac{5}{64}$ ", 2mm cutting width, 20/pk.
S146/R-2	ROUND BLADE, $\frac{1}{8}$ ", 3mm cutting width, 20/pk.
S146/R-3	ROUND BLADE, $\frac{13}{64}$ ", 5mm cutting width, 20/pk.
S146/R-4	ROUND BLADE, $\frac{9}{32}$ ", 7mm cutting width, 20/pk.
S146/R-5	ROUND BLADE, $\frac{23}{64}$ ", 9mm cutting width, 20/pk.
S146/W-1	ANGLE BLADE, $\frac{5}{64}$ ", 2mm cutting width, 20/pk.
S146/W-2	ANGLE BLADE, $\frac{5}{32}$ ", 4mm cutting width, 20/pk.
S146/W-3	ANGLE BLADE, $\frac{1}{4}$ ", 6mm cutting width, 20/pk.
S146/W-4	ANGLE BLADE, $\frac{5}{16}$ ", 8mm cutting width, 20/pk.
S146/W-5	ANGLE BLADE, $\frac{13}{32}$ " cutting width, 20/pk.
S146/W-6	ANGLE BLADE, $\frac{7}{8}$ ", 22mm cutting width, 20/pk.

Product Index

Item Number	Page				
09	25	198	8	315-2013MD	80
10	25	199	8	315-2014D	80
10T	25	203	27	315-2014M	80
11	25	204	27	315-2014MD	80
11T	25	206	27	315-2014R	80
12	25	208	27	315-2015M	80
12T	25	209	27	315-2015MD	80
13	25	211	27	315-2016D	80
13T	25	212	27	315-2016M	80
14	25	215	26	315-2016MD	80
15	25	216	26	315-2016R	80
16	25	217	27	315-2017M	80
16T	25	220	26	315-2017MD	80
17	25	222	26	315-2018D	80
17T	25	224	26	315-2018M	80
18	25	226	26	315-2018MD	80
19	25	249UL	3	315-2018R	80
20	25	250-1UL	5	315-2019M	80
100	29	250UL	3	315-2019MD	80
111	25	250UL/24	3	315-2020D	80
111R	9	251-1UL	5	315-2020M	80
111TM	9	251UL	3	315-2020MD	80
112R	5, 9	251UL/24	3	315-2020R	80
115	25	252	4	315-2021M	80
116	25	252-1	5	315-2021MD	80
117NB	25	253	4	315-2022D	80
164	6	253-1	5	315-2022M	80
164R	9	254-1	5	315-2022MD	80
165T	6	262	4, 5	315-2022R	80
165TM	9	269	3, 36	315-2024D	80
165	6	270	3, 5, 26, 36	315-2024R	80
166	6	270P	3, 5, 36	315-2026D	80
166R	9	271	3, 5, 36	315-2026R	80
167	6	271/38	3, 5, 36	315-2028D	80
167T	6	271P	36	315-2028R	80
167TM	9	272	3, 5, 36	315-2030D	80
169	6	275	36	315-2030R	80
169R	9	280	36	315-2110M	81
170	6	282	36	315-2110MD	81
170R	9	283	36	315-2111M	81
170TM	9	284	36	315-2111MD	81
172	6	284C	36	315-2112D	81
172R	9	286	36	315-2112M	81
172TM	9	290UL	3	315-2112MD	81
174	6	291-1UL	5	315-2112R	81
174R	9	291UL	3	315-2113M	81
174TM	9	292UL	3	315-2113MD	81
176	8	315-1312	80	315-2114D	81
176TM	9	315-1312D	80	315-2114M	81
177	8	315-1319	80	315-2114R	81
177R	9	315-1319D	80	315-2115M	81
177TM	9	315-1326M	80	315-2115MD	81
178	8	315-1326MD	80	315-2116D	81
178R	9	315-1412M	80	315-2116M	81
178TM	9	315-1412MD	80	315-2116MD	81
179	8	315-1504FW	80	315-2116R	81
179R	9	315-1719	81	315-2117M	81
179TM	9	315-1719D	81	315-2117MD	81
180	8	315-1726M	81	315-2118D	81
180R	9	315-1726MD	81	315-2118M	81
180TM	9	315-2010M	80	315-2118MD	81
182	8	315-2010MD	80	315-2118R	81
182R	9	315-2010UMD	80	315-2119M	81
182TM	9	315-2011M	80	315-2119MD	81
184	8	315-2011MD	80	315-2120D	81
184R	9	315-2012D	80	315-2120M	81
184TM	9	315-2012M	80	315-2120MD	81
196	8	315-2012MD	80	315-2120R	81
197	8	315-2012R	80	315-2121M	81
		315-2013M	80	315-2121MD	81
				315-2122D	81
				315-2122M	81
				315-2122MD	81
				315-2122R	81
				315-2124D	81
				315-2124R	81
				315-2126D	81
				315-2126R	81
				315-2128D	81
				315-2128R	81
				315-2130D	81
				315-2130R	81
				315-2146DT	80
				315-2192DT	80
				315-2214MD	81
				315-2228A	81
				315-2238A	81
				315-2239UJ	81
				315-2243E	81
				315-2243EH	81
				315-2245E	81
				315-2245EH	81
				315-2247E	81
				315-3008A	82
				315-3008AL	82
				315-3009A	82
				315-3009AB	82
				315-3009AL	82
				315-3019M	82
				315-3019MD	82
				315-3020M	82
				315-3020MD	82
				315-3021M	82
				315-3021MD	82
				315-3022M	82
				315-3022MD	82
				315-3023M	82
				315-3023MD	82
				315-3024D	82
				315-3024M	82
				315-3024MD	82
				315-3024R	82
				315-3025M	82
				315-3025MD	82
				315-3026D	82
				315-3026M	82
				315-3026MD	82
				315-3026R	82
				315-3027M	82
				315-3027MD	82
				315-3028D	82
				315-3028R	82
				315-3030D	82
				315-3030R	82
				315-3032D	82
				315-3032R	82
				315-3034D	82
				315-3034R	82
				315-3036D	82
				315-3036R	82
				315-3038D	82
				315-3038R	82
				315-3040D	82
				315-3040R	82
				315-3042D	82
				315-3042R	82
				315-3223C	82
				315-3235MC	82
				315-3241MC	82
				315-4003E	84

Product Index

315-4003EL	84	315-8026MD	82	751-5G	24	939	30
315-4006HUJ	84	315-8029	82	751-55G	24	940	31
315-4006UJ	84	410SV	29	753	49	941	31
315-4007E	84	418-08907	33, 49	760	6, 24, 50, 52	942	31
315-4007EL	84	418-08910	33, 49	761	24	946W	32
315-4008A	84	500	29	762	24	946Y	32
315-4008AB	84	600	5	765	24	947W	32
315-4008AL	84	600T	5	766	24	947Y	32
315-4009A	84	601	5	767	24	948	33
315-4010E	84	602	5	768	24	948Y	33
315-4010EL	84	603	11	770	24, 26	949	30
315-4013E	84	603R	12	772	31	950W	33
315-4013EL	84	604	11	775	24	950	33
315-4019M	83	604R	12	776	24	951	33
315-4019MD	83	605	11	777	24	951Y	33
315-4021M	83	605R	12	783	48	963	48
315-4021MD	83	606	11	783-5E	48	964	48
315-4022M	83	606R	12	830	50	966	30
315-4022MD	83	607	11	848	23	968LB	24
315-4023M	83	607R	12	849	22	968RLB	24
315-4023MD	83	608	11	850	22	969	24
315-4024D	83	608R	12	854	23	971	48
315-4024M	83	609	11	855	22	973	30
315-4024MD	83	609R	12	858	23	974	30
315-4024R	83	610	11	859	23	975	24
315-4025M	83	610R	12	861	22	976	105
315-4025MD	83	620	11	862	22	977	105
315-4026D	83	621	11	863	22	978	105
315-4026M	83	622	11	864	22	982	51
315-4026MD	83	623	11	865	22	985	30
315-4026R	83	624	11	866	22	986	30
315-4027M	83	625	11	867	22	990	87
315-4027MD	83	626	11	868	22	1082	24
315-4028D	83	627	11	869	22	1082G	24
315-4028M	83	672	31	870	22	1082-5G	24
315-4028MD	83	704	6, 24, 50, 52	872	28	1082-55G	24
315-4028R	83	704A	6, 24	880	28	1150	52
315-4029M	83	704G	24	883	28	1151	52
315-4029MD	83	704-5G	24	885	28	1152	52
315-4030D	83	704-55G	24	896	28	1153	52
315-4030M	83	705C	24, 49	896NHTK	28	1154	52
315-4030MD	83	706-1	24	898	28	1155	52
315-4030R	83	707HD-5G	53	900	30	1156	52
315-4031M	83	708HD	53	901	30	1157	52
315-4031MD	83	709HD	53	903	27	1158	52
315-4032D	83	711	53	903RC	27	1159	52
315-4032R	83	720	48	905	27, 30	1160	52
315-4034D	83	720-5G	48	910	30	1161	52
315-4034R	83	720-55G	48	911	3, 5, 26	1162	52
315-4036D	83	721	48	912	3, 5	1163	52
315-4036R	83	722	48	913	30	1167	52
315-4038D	83	723	48	915	26, 27, 30	1181	52
315-4038R	83	723M	48	916	26, 27	1182	52
315-4040D	83	725M	48	918	30	1183	52
315-4040R	83	730	34	919	30	1184	52
315-4042D	83	730C	34	920	27, 30	1185	52
315-4042R	83	731	34	921	27, 30	1186	52
315-4044D	83	732	34	923	27, 30	1187	52
315-4044R	83	732C	34	925	26	1188	52
315-4223C	83	734	48	925E	26	1612	31
315-4235MC	83	734-5G	48	925T	26	6213	25
315-4238MC	83	734-55G	48	926	26	6214	25
315-4241MC	83	734Q	48	927	26	6218	25
315-4313S	83	735	6	928	26	6220	25
315-4313SHD	83	738	6, 24, 50, 52	928B	?	6230	25
315-4315S	83	738G	24	931	30, 86	96010	33
315-4317S	83	739	24, 49	933	30, 50, 52	AH440	77
315-4319S	83	743	34	935	30	AME11000	89
315-4320S	83	743SP	34	936	30	AME11010	89
315-4321S	83	751	6, 24	938	30, 50, 52	AME11030	89

Product Index

AME11044	89	CHART - Tech	ESC060301	86	HAL753S-181/2	68
AME11075	89	Off Road (TOR) &	ESC070100	88	HAL753S-19	68
AME13000	89	Bias Skidder Repair . .	FP-708	35	HAL753S-201/2	68
AME13010	89	CHART - Tech	FP-755	35	HAL753S-21	68
AME13030	89	Off Road (TOR)	G12026B	98	HAL753S-211/2	68
AME13050	89	Bias OTR Repair	G12100	95	HAL753S-221/2	68
AME13060	89	CHART - Tech Radial	G12100-7	95	HAL753S-23	68
AME13070	89	OTR Repair Chart	G12100-8	95	HAL753S-231/2	68
AME13100	89	Centech Aramid	G12894-C	95	HAL753S-241/2	68
AME13121	89	Reinforced Repair . . .	G12894P	95	HAL753S-25	68
AME14465	89	CHART - Tech	G12912	94	HAL753S-291/2	68
AME15000	89	Uni-Seal Ultra, Uni-Seal	G12912A	94	HAL753S-31/2	68
AME15002	89	Ultra Max & Bias	G12913	94	HAL753S-32	68
AME15230	89	Uni-Seal Repair	G12913B	94	HAL753S-4	68
AME15260	89	Limitations for Radial &	G12914	94	HAL753S-41/2	68
AME15920	89	Bias Crown Injuries . . .	G12914B	94	HAL753S-6	68
AME16040	89	CP749-2	G12915B	94	HAL753S-8	68
AME16050	89	CP772H	G12916	94	HAL753S-9	68
AMF855	77	CP7729	G12916B	94	HAL89-2WASV	76
AX80U	50	CP7733-2	G12917	94	HAL89-3W	76
B-2	50	CP7782-6	G12917B	94	HAL89-3WASV	76
B-2PR	50	CP797-6	G12919B	94	HAL89-3WTK	76
BARWRT400SUL1	55	CP871	G412000	96	HAL89HKC-12	76
BARWRT400SUL2	55	CP871K	G412001	96	HAL89HKC-12M	76
BARWRT400SUL3	55	CP873	G420300	97	HAL89HKC-24	76
BARWRTPAD2	56	CP873K	G420300-25	97	HAL89HKC-24M	76
BARWRTPADSUL1	56	CP9288	G420302	97	HAL89HKC-25C	76
BARWRTPADSUL2	56	CT46A	G422500	97	HAL89HKC-50	76
BCL	50	CT46AR	G432003	96	HAL89HKC-50C	76
BN18	23	E10100	G432020	96	HAL89HKI-25	76
BRA5120	51	E10101	GAI12880	95	HAL89HKT-12	76
BRA5500	51	E10312	GAI12880E	95	HAL89HKT-12M	76
BRALR	51	E10500	GAI12894	95	HAL89HKT-24	76
BRALREF	51	E70150	GAI12894-CW	95	HAL89HKT-24M	76
BT18	23	E70160	GAI12904	98	HAL89HKT-50	76
BTLG-125/10#	23	EP10044	GAI451205	97	HAL89HMTVN	76
CHART- AX Aramid		EP10045	GAIG12100-1	95	HAL89HVI-25	76
Reinforced Radial		EP2244	GAIG12923	94	HAL89XDA	76
OTR Severe		EP2245	GAIG12925	94	HAL89XDB	76
Service Repair	18	EP5644	GAIG411500	96	HALCH-330-LO-OP	76
CHART - Bias		EP5645	GAIG413000	96	HALCH-330-OP-1	76
2-Piece Nail		EP6644	GAIG450301	97	HALCH-360-OP-1	76
Hole Repair		EP6645	GAIG451600	97	HALCH-360S	76
Limitations	7	EP8544	GAIGHP-01	97	HALG-170S	64
CHART - BP		EP8545	GAIGHP-01Y	97	HALG-550	62, 64
Bias Repair	13	ESCO10102	GAIGT-3531	96	HALGA-240	74
CHART - Centech		ESCO10200	GAIGTABB-01	98	HALGA-255	74
& Thermacure		ESCO10202	GAITO-01TB	98	HALGCS-A	75
Radial Repair	10	ESCO10207	GAVTK	94	HALIN-20	73, 76
CHART - Centech		ESCO10209	GB-5Z	94	HALIN-80A	69
Aramid Reinforced		ESCO10300	GB-5ZA	94	HALLR-25	71
Radial OTR		ESCO10543M	GBB6L	94	HALLR-29	71
Repair	15	ESCO10592	GBB9L	94	HALLR-33	71
CHART - Centech		ESCO10806	GGB-55	94	HALLR-35	71
OTR Repair		ESCO30120	GH100	23	HALLR-39	71
Recommendations:		ESCO30125	GH200	23	HALLR-45	71
Chemical, Thermacure,		ESCO40100	GH218	23	HALLR-49	71
Cloth Backed &		ESCO40107	GHP-01R	97	HALLR-51	71
Heat Cure	14	ESCO50100	GSL	50	HALLR-57	71
CHART - OTR Vulcanizing		ESCO50303	GTS-01	51	HALLR-63	71
System Radial/Bias Ply		ESCO60100	HAL307	73	HALLR-69	71
Application Chart	43	ESCO60101	HAL5131	73	HALM-1900-8	69
CHART - Radial		ESCO60102	HAL753S-10	68	HALM-1950-8	69
2-Piece Nail Hole		ESCO60104	HAL753S-111/2	68	HALMT-3000	69
Repair Limitations	7	ESCO60105	HAL753S-12	68	HALN-1410	73
CHART - Tech AX Severe		ESCO60106	HAL753S-131/2	68	HALNI-106	78
Service		ESCO60107	HAL753S-16	68	HALOR-215-H	71
Radial Repair	16	ESCO60108	HAL753S-17	68	HALOR-463-T	71
CHART - Tech Bias		ESCO60109	HAL753S-171/2	68	HALOR-469-T	71
Skidder Tire Repair . . .	12	ESCO60300	HAL753S-18	68	HALPT-300-J-650	70

Product Index

HALPT-EX	70	KEN34645	90	MONM4220H	42, 44	PECWW075	102
HALPT-GAUGE	70	KEN34645C	90	MONM4224H	44	PECWW075ST	102
HALR-520	69	KEN34647	90	MONM45/6/71HG	44	PECWW075Z	102
HALR-525	69	KEN34648	91	MONM4824H	44	PECWW150	102
HALR-660	69	KEN34652	92	MONM4824W	42, 44	PECWW150ST	102
HALR-760-100	70	KEN34747	90	MONM4832E	44	PECWW150Z	102
HALR-760-50	70	KEN34748	90	MONM5054/32W	44	PEQS2000	101
HALR-969-K	70	KEN34749	90	MONM5224	44	PEQS3000	101
HALR-969K-1	70	KEN34847	90	MONM5432W	42, 44	Perfect	
HALSLBHAT	70	KEN34848	90	MONM6732W	44	Wheel Weights	99 - 102
HALSTAND-4	76	KEN34849	90	MONM7532W	44	PESK2000	101
HALT-620	70	KEN34950	91	MONMVS5001/202	44	PESK3000	101
HALT-81	69	KEN35104	91	MONMX202	44	PESSG060N	101
HALT-82	69	KEN35105	91	MONMX203	44	PESSG7500N	101
HALWHG-8018VC	68	KEN35321	91	MONOS2117	45	PESSM600N	101
HALWHG-8019VC	68	KEN35323	91	MONOS2517	45	PESST300N	101
HN8	31	KEN35325	91	MONOSH2215	45	PESST32000N	101
Hofmann Wheel		KEN35327	90	MONOSH2815	45	PS-1	51
Weights	103, 104	KEN35329	90	MONPTM	46	RAH1225	77
IDOR220	50	KEN35421	91	MONSRS	46	RAH1250	77
J1	95	KEN35423	91	MONTR1315/15W	46	RAH12700	77
KEN29980	56	KEN35425	91	MONTR1315/20W	42, 44	RAH14700	77
KEN29981	56	KEN35427	90	MONTR2210H	46	RAH3825	77
KEN29982	56	KEN35429	90	MONTR2213H	46	RAH3850	77
KEN29983	56	KEN35440	90	MONTR2621E	42, 44	RAH38700	77
KEN29984	56	KEN35595	93	MONTR2621H	42, 44	RFAMT	50
KEN29985	56	KEN35620	93	MONTR911/13W	46	RFP	50
KEN30060	56	KEN35630	93	MONTRDD	46	RFU	50
KEN30165	86	KEN35635	93	MONTRM	46	RH100	37
KEN30515	86	KEN35656	93	MONTRM4815	46	RH100GEG-134-80	38
KEN30606	87	KEN35657	93	MONTRM4815	46	RH100GEG-138-80	38
KEN30609	92	KEN35659	93	MONTROCXL	42, 44	RH100GEG-200-80	38
KEN30610	92	KEN35662	93	MONTRRS	46	RH102	37
KEN30612	92	KEN35663	93	MONXLBRS	45	RH104	37
KEN30618	86, 92	KEN35663	93	MONXLOTRS	45	RH107	37, 50, 52
KEN30619	92	KEN35690	93	NIA0422	49	RH109	37
KEN30620	86, 92	KEN35695	93	NIA2539-25	48	RH111	37
KEN31551	51	KEN35697	93	NIA2539-8	48	RH112	37
KEN31554	51	KEN35795	93	OLVRH114	37	RH118-3/8	37
KEN31710	90	KEN35924	91	OLVRH116	37	RH120	37
KEN31810	90	KEN35926	91	OLVRH707-50	38	RH122	37
KEN32101	90	KEN35936	91	OLVRH708-50	38	RH129P	37
KEN32102	90	KEN36001	92	OR220TG	71	RH140	37
KEN32106	92	KEN36002	92	OR224TG	71	RH152	37
KEN32109	92	KEN36007	92	OR24JM	71	RH154	37
KEN32116	92	KEN36015	93	OR25T	71	RH156	37
KEN32119	90	KEN36016	93	OR325T	71	RH300	37
KEN32120	90	KEN36017	93	OR329T	71	RH302	37
KEN32121	90	KEN39805	92	OR333T	71	RH304	37
KEN32123	91	LINT003	47	OR335T	71	RH306	37
KEN32125	91	LINT005	47	OR339T	71	RH308	37
KEN32126	92	LINT009	47	OR345T	71	RH310	37
KEN32127	91	LINT011	47	OR349T	71	RH312	37
KEN32128	91	LINT016	47	OR451T	71	RH314	37
KEN33195	90	LINT018	47	OR457T	71	RH601	38
KEN33196	90	LINT022	47	PB-ATC	49	RH603	38
KEN33199	90	LINT026-120	47	PB-B	49	RH605	38
KEN33219	90	LINT026-240	47	PE100360	101	RH611	38
KEN33220	90	LINT029	47	PE100360B	101	RH613	38
KEN33223	91	LINT148	47	PE100360C	101	RH619	38
KEN33224	91	LRR	22	PE100360S	101	RH626	38
KEN33238	90	MH26470	31	PE100720	101	RH635	38
KEN33239	90	MONBRS	46	PE200624	101	RH708	38
KEN33341	92	MONM100	42, 44	PE200624ST	101	RSB3	38, 86
KEN33342	92	MONM1721/24W	42, 44	PE200624STR	101	RSB3E	38
KEN34121	90	MONM2519H	42, 44, 46	PE300360	101	RTMS	9
KEN34122	90	MONM2626H	42, 44, 46	PE300360ST	101	S1009	39
KEN34401	93	MONM2732/32W	44	PECL12	101	S1010C	35
KEN34402	93	MONM3015H	42, 44	PECL6	101	S1010K	35
KEN34644	90	MONM3132H	44	PECWW060	102	S1011	39
		MONM3842/32W	44	PECWW074	102		

Product Index

S1011-1	39	S2043	41	SP208/16	41	TMRTCR343-6	106
S1016	47	S2045	41	SP208/36	41	TMRTI11400096	107
S1016-220	47	S2046	41	SS10	31	TMRTI30	108
S1035	35	S2047	41	TCG	23	TMRTI155	108
S1036	35	S2204	39	TL100	53	TMRTI182961	107
S1037	35	S3/M10/291TM	9	TL150	53	TMRTI20011064	107
S1039	35	S870	36	TL200	53	TMRTI254341A	107
S1040	3, 5, 35	S872	36	TL250	53	TMRTI4096-10	107
S1041	3, 5, 35	S872S	36	TLP60	53	TMRTI4636-10	107
S1041/38	3, 5, 35	S873	36	TM300	53	TMRTI851855	108
S1043	3, 35	S874	36	TM400	53	TMRWL98063	51, 108
S1044	35	S875	36	TM500	53	TNT-100-1	84
S1046	35	S879	36	TMRAG107518	108	TNT-200-1	84
S1046D	35	S890	40	TMRAG107985	108	TNT-200-M	84
S1047	35	S891	40	TMRCT768	108	TNT-100	84
S1047XL	35	S892	40, 50, 52	TMRCW10-50	41	TNT-200	84
S1048	35, 41	S893	40	TMRCW15	41	TNT-100-3	84
S1049	35, 41	S894	40, 86	TMRCW1-50	41	TNT-100-8	84
S1055N	34	S896	40	TMRCW15-50	41	TNT-100-9	84
S1056	34	S897	40	TMRCW2-10	41	TNT-100-10	84
S145A	113	S898	40	TMRCW5-50	41	TNT-100-11	84
S145B	113	S918	34	TMRHA106871	108	TP6000	53
S145/R-1	113	S920	34	TMRHA67715	108	TP7000	53
S145/R-2	113	S923	34	TMRLB106259	108	TPMS1030K	57
S145/R-3	113	S924	34	TMRLB106572	108	TPMS1040K	57
S145/R-4	113	S925	34	TMRMI215-100	112	TPMS1050K	57
S145/R-5	113	S946	40	TMRMI225-100	112	TPMS1060K	57
S145/W-1	113	S947	40	TMRMI235-100	112	TPMS1070K	57
S145/W-2	113	S990	35	TMRMI245-100	112	TPMS1080K	57
S145/W-3	113	S991	35	TMRMI315-100	112	TPMS1090K	57
S145/W-4	113	S992	35	TMRMI325-100	112	TPMS1100K	57
S145/W-5	113	S999	29	TMRMI335-100	112	TPMS1110K	57
S145/W-6	113	SBCT16	86	TMRMI345-100	112	TPMS1130K	57
S146A	113	SBCT22	86	TMRMI197-100	112	TPMS1204A	54
S146B	113	SCBR16	86	TMRMI297-100	112	TPMS1206A	54
S146/R-1	113	SCBR22	86	TMRMI397-100	112	TPMS2000K	57
S146/R-2	113	SIP	30	TMRMI17-100	112	TPMS20014	54
S146/R-3	113	SIR123	85	TMRMI27-100	112	TPMS2010K	57
S146/R-4	113	SIR149	85	TMRMI37-100	112	TPMS2020K	57
S146/R-5	113	SIR235	85	TMRMI202-50	112	TPMS2030K	57
S146/W-1	113	SIR304L	85	TMRMI203-50	112	TPMS2040K	57
S146/W-2	113	SIR304R	85	TMRMI204-50	112	TPMS33000	54
S146/W-3	113	SIR306L	85	TMRMI302-25	112	TPMS33200	54
S146/W-4	113	SIR306R	85	TMRMI303-25	112	TPMS34000	54
S146/W-5	113	SIR333B	85	TMRMI304-25	112	TPMS5415	56
S146/W-6	113	SIR654	85	TMRMI305-50	112	TPMS5535	56
S180	31	SIR708ARY	85	TMRMI306-50	112	TPMS55351	56
S182	22, 31	SIR709ALY	85	TMRMI307-50	112	TPMS7001HP	54
S2000	39	SIR715	85	TMRMI308-25	112	TPMS7001HPR	54
S2001	39	SIR716	85	TMRMI309-25	112	TPMS7002	54
S2002	39	SIR888RZ	85	TMRMI310-25	112	TPMS7004	54
S2003	39	SIR889LZ	85	TMRMI20	112	TPMS7020K	54, 57
S2004	39	SIR892ALY	85	TMRMI200	112	TPMS7100	57
S2005	39	SIR896LY	85	TMRTC0343-6	106	TPMS8100	56
S2006	39	SIR896RY	85	TMRTC101608	107	TPMS925A	57
S2007	39	SIR897LY	85	TMRTC113125C	107	TPMS925B	57
S2008	39	SIR897RY	85	TMRTC14024784	106	TPMS925C	57
S2009	39	SIR912R	85	TMRTC181354	108	TPMS950S	57
S2010	39	SIR913L	85	TMRTC182788	107	TPMS950SC/4PK	57
S2011	39	SIR919	85	TMRTC182960	106	TPMS9700	56
S2020	39	SIR988LY	85	TMRTC183061	106	TPMSRC	57
S2020-101	41	SIR988RY	85	TMRTC183604	107	TPMSVS70	54
S2020-104	41	SIR993	85	TMRTC184432	106	TPMSVS70B	54
S2021	39	SK12R	12	TMRTC20024335	106	TPMSVS80	54
S2022	39	SK16R	12	TMRTC247G15A-10	107	TR413CH/50	58
S2023	39	SK20R	12	TMRTC250309	106	TR418CH/100	58
S2027	39	SK24R	12	TMRTC2505	108	TRI20008	57, 58
S2032	39	SLP6550	35	TMRTC450310	106	TRI412	60
S2040	41	SP204/16	41	TMRTCR343	106	TRI412L	60
S2042	41	SP204/36	41			TRI413/500	58

Product Index

TRI414/50	58	VH660	74	VHI545E/BG	61	VHIE327-27	63
TRI415/50	58	VH663	74	VHI546	61	VHIE58MS9745	63
TRI418/500	58	VH666	73	VHI546/BG	61	VHIEV37NI-N	59
TRI423/50	58	VH666CLR	73	VHI546D	61	VHIEV42NI	59
TRI425	58	VH667	74	VHI546D/BG	61	VHIEV42NI-N	59
TRR	22	VH670	72	VHI546E	61	VHIEV42SNI	59
TRT105	30, 36	VH671	72	VHI546E/BG	61	VHIFVE125	66
TSN100	85	VH672	72	VHI594	67	VHIFVE140	66
UWT1000-3	105	VH673	72	VHI596	67	VHIFVE160	66
UWT1200-1	105	VH674	72	VHI600HP	59	VHIFVE160B	66
UWT1200HP	105	VH675	72	VHI638	59	VHIFVE180	66
UWT2200HP	105	VH678	72	VHI651-45	59	VHIFVE180B	66
UWT9000-1	105	VH686	77	VHI657	59	VHIFVE210	66
UWT9000-2	105	VH687	77	VHI661	74	VHIFVE210B	66
UWT9000-4	105	VH688	77	VHI662	74	VHIFVE250	66
UWT9000-5	105	VH689	77	VHI662-90	59	VHIFVE250B	66
UWT9000-52	105	VH694	77	VHI664	74	VHIFVE270B	66
UWT9000-53	105	VH695	77	VHI665	74	VHIFVE280	66
UWT9000-72	105	VH82	64	VHI665M	75	VHIH668	75
UWT9000-73	105	VH822	64	VHI668	74	VHIH698	75
VALVEPAL	72	VH823	64	VHI669	74	VHIJ651	67
VH3215	72	VH824	64	VHI690	77	VHIJ652	67
VH3216	72	VH827	64	VHI691	77	VHIN321	63
VH34	65	VH936A	67	VHI692	77	VHIN3221	63
VH35	65	VH936B	67	VHI693	77	VHIN323	63
VH36	65	VHB9A	67	VHI696	77	VHIN324-27	63
VH37	65	VHC15	78	VHI698	77	VHIN325-27	63
VH430HT-F	64	VHC27	78	VHI722MS	60	VHIN326-27	63
VH552	62	VHC28	78	VHI723MS/BG	60	VHIN327-27	63
VH553	62	VHC37	78	VHI724-23	60	VHIV30210	61
VH553C	62	VHC38	78	VHI724-23/BG	60	VHIV30212	61
VH553E	62	VHC50	78	VHI724MS/BG	60	VHIV3121	63
VH554D	62	VHC75	78	VHI72590	60	VHIV3131	63
VH555D	62	VHC77	78	VHI725MS	60	VHIV3141	63
VH555E	62	VHC78	78	VHI725MS/BG	60	VHIV411	59
VH5562B	61	VHC803	78	VHI72690	60	VHIV416-20/BG	59
VH5566B	61	VHC805	78	VHI726MS/BG	60	VHIV5101	67
VH5567B	61	VHC807	78	VHI72790	60	VHIVC2	64
VH580	67	VHC808	78	VHI727MS/BG	60	VHIVC8-G	64
VH582	67	VHC809	78	VHI72890	60	VHJ440	64
VH584	67	VHC810	78	VHI728MS/BG	60	VHJ4450	67
VH591	25	VHC815	78	VHI729MS	60	VHJ450	64
VH592	25	VHC817	78	VHI729MS/BG	60	VHJ4600	67
VH595	67	VHC818	78	VHI734/BG	61	VHJ4750	67
VH597	67	VHC83	78	VHI736/BG	61	VHJ4900	67
VH598	73	VHC84	78	VHI755	62	VHJ59	68
VH599	73	VHC85	78	VHI755/BG	62	VHJ608	72
VH599RK	73	VHC90	78	VHI756/BG	62	VHJ6100	77
VH60GRY	64	VHC91	78	VHI758	62	VHJ6102	77
VH601	65	VHC92	78	VHI758/BG	62	VHJ6105	77
VH602	65	VHCEZ12	78	VHI801HP	59	VHJ67	68
VH602HP	59	VHCEZ14	78	VHIBL108TP	65	VHJ690	67
VH603	65	VHI401	60	VHIBL133TP	65	VHJ7678	68
VH604	72	VHI407	59	VHIBL153TP	65	VHJ7734	68
VH605	72	VHI430A	60	VHIBL163TP	65	VHJ7900	68
VH606	56, 72	VHI430HT/1	64	VHIBL29B45	65	VHJ829	64
VH607	72	VHI521MS	59	VHIBL34B90	65	VHJAD4	67
VH608	72	VHI53/1	64	VHIBL34TP	65	VHJSP2	67
VH609	56, 72	VHI53/1S	64	VHIBL78TP	65	VHP698L	75
VH643	65	VHI542	61	VHIBL98TP	65	Wheel Weights,	
VH645	65	VHI543/BG	61	VHIBLH11	66	Hofmann	103 - 104
VH646	65	VHI543C/BG	61	VHIBLH21	66	Wheel Weights,	
VH651	74	VHI543D/BG	61	VHIBLH22	66	Perfect	99 - 102
VH651RH	74	VHI543E/BG	61	VHICAPS	64	WRT300PSDSUL1	55
VH652	74	VHI544	61	VHIE321	63	WRT300PSDSUL2	55
VH652RH	74	VHI544/BG	61	VHIE32217	63	WRT300PSDSUL3	55
VH653	74	VHI544E	61	VHIE323	63	WRT400SD	55
VH65558	68	VHI544E/BG	61	VHIE324-27	63	WRTPAD1	56
VH656/58	64	VHI545	61	VHIE325-27	63	WRTRST50	55
VH65658	68	VHI545/BG	61	VHIE326-27	63		

TECH

Training & Support Materials

Tech offers an extensive array of step-by-step “How to Repair” information. Our “How to Repair” manuals are designed to simply and effectively demonstrate correct, proven methods to properly repair all types of tires. Tech wall charts clearly and quickly communicate “How to Repair” procedures and provide detailed instructions on selecting the correct repair unit for the job.

Repair Hot Line for continental United States and Canada, 1-800-433-TECH or 1-800-336-TECH.

TECH “HOW TO REPAIR” MANUALS

Cat. No.	Description
RM-1	TUBE REPAIR
RM-2	VALVE REPAIR
RM-4	250UL & 251UL UNI-SEAL ULTRA REPAIR on a Speed Rated Tire
RM-5	2-PIECE REPAIR
RDVD1	UNI-SEAL & TWO-PIECE NAILHOLE REPAIR DVD

RM-1 through RM-5 also available in Spanish.
Add suffix “S” to catalog number when ordering. Example: RM-1S.



TECH WALL CHARTS

Cat. No.	Title	Description
BP	BP Bias Ply Size of Injury	Large wall chart contains complete information on proper selection of BP bias ply repair units
CT	Centech Size of Injury/Repair Selection Chart	Large wall chart contains complete information on selecting the proper Centech radial repair units for passenger, light truck, medium truck & tractor tires
CTOR	Centech Off Road Repair Selection Chart	Large wall chart contains complete information on selecting the proper Centech radial OTR repair units
PTC	Uni-Seal Ultra Repair Chart	Large wall chart featuring the application of Uni-Seal Ultras in passenger, light truck and truck tires.
2PC	Two-Piece Wall Chart	Large wall chart featuring the application of Two-Piece style repairs in passenger, light truck and truck tires.
TOR	TOR Wall Chart	Large wall chart contains complete information on selecting the proper Tech TOR repair unit for off-road tires.
VHSC	Tech Valve Hardware Selection Chart	Large wall chart contains complete information on selecting proper valve hardware for passenger, light truck and medium truck applications.



TECH INTERNATIONAL

Authorized Tire Repair Technician Training Programs

**Teach
Each
Customer
How**



Profit From Tire Repair Education

Tech International began factory training of our sales force and customers in 1970. Today, Tech offers specific tire repair courses that incorporate the latest tire repair techniques recommended by the major tire manufacturers, as well as the most cost effective methods of tire repairing. All of these courses include classroom instruction on today's most current construction, tire size and inspection information. Tech's Authorized Repair Technician Programs are available at Tech's Corporate Headquarters, at one of our regional training centers around the world, or at your location. Training at any of Tech's training facilities is highly recommended because of the superior hands-on training.

What good does specialized training do? It lets you...

- Improve customer satisfaction
- Make proper tire repairs
- Increase profitability
- Decrease repair liability
- Decrease costs

Automotive Tire Dealer Seminar



This two day seminar is designed specifically for automotive technicians with the focus on passenger tire service. Tech stresses the importance of proper repair procedures for standard passenger, high performance and run-flat tires. The second portion of the seminar includes the Tire Industry Association (TIA) Basic ATS Program. Basic ATS meets the need for documented training of new and experienced automotive technicians. This section includes basic principles of tires and wheels, mounting and demounting using center post and rim clamp machines, balancing, using a lift, and proper torque procedures. The final portion of the seminar covers the servicing of tires with Tire Pressure Monitoring Systems (TPMS). Students who meet Tech's hands-on requirements and pass the written exam will receive the Tech Authorized Nailhole Repair Technician certificate and arm patches. Basic ATS training certificates will be issued from TIA for those who pass the written TIA exam.

Commercial Tire Service Seminar



This two day seminar is the general tire repair course covering construction, inspection and basic repair of commercial truck tires. The repair methods taught in this course are the most current industry recommended procedures utilizing both one-piece and two-piece style nailhole repairs. The second portion of the course includes the Tire Industry Association's (TIA) Basic CTS program. This classroom training covers OSHA Regulation 29CFR Part 1910.177 servicing single piece and multi-piece rim wheels. Students who meet the requirements will receive the TIA Basic CTS certificate and Tech Authorized Nailhole Repair Technician certificate and arm patches.

TECH INTERNATIONAL

Authorized Tire Repair Technician Training Programs

OTR Section Repair Seminar

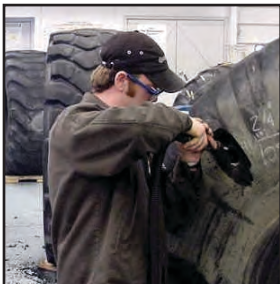

The OTR tire repair course is a specialty course conducted at Tech's Johnstown, Ohio training center. In this course, the student learns the latest techniques used in the section repair of bias and radial off road tires. The course also covers the latest OTR tire construction, tire storage requirements and tire inspection techniques. All students are required to complete hands-on demonstrations and a written exam. When the attending students pass the written exam and complete all of the hands-on requirements, they will receive Tech's Authorized OTR Tire Repair Technician certificate and arm patches.

Commercial & Ag Tire Repair Seminar



This two day seminar covers the proper repair of passenger, light , medium, and heavy truck tires, and agricultural tires. Over the course of two days, the participants will learn about tube repairs, Permacure and Flow Seal inserts, and proper nail hole repair methods in passenger through heavy truck tires. Additional larger repairs in Truck and agricultural tires will be explained and demonstrated. All students are required to complete hands-on demonstrations and a written exam. Students who meet Tech's hands-on requirements and pass the written exam will receive the Tech Authorized Nailhole Repair Technician certificate and arm patches.

On-Site Nail Hole Repair Training



Tech International has a knowledgeable training staff, along with fully trained regional managers and a network of Tech distributors to satisfy all of your training needs. Tech has conducted training programs to train and authorize our entire distributor network. In the United States and Canada, nailhole repair training courses are also conducted by our well-trained distributors. We have over 40 years experience in training repair personnel using the latest tire repair techniques. Please contact Tech International or your local Tech Distributor for a factory training course schedule or to set up an in-house training seminar.

For more information, contact the Training Department at Tech International

Phone (800) 433-8324 | (800) 336-8324 | (740) 967-9015

Fax (740) 967-7203 | Visit our website at: www.tech-international.com





Are You Getting Your Share of TPMS Business?

If you aren't, you're missing out on a huge revenue opportunity.

The U.S. government requires that all passenger cars, light trucks and vans be equipped with a Tire Pressure Monitoring System, starting in model year 2008. Due to a phase-in of the requirements, 20 percent of model year 2006 and 70 percent of model year 2007 vehicles are equipped with TPMS. That's a lot of TPMS valves on the road!

It is estimated that 14,000,000 sensors will begin to fail this year due to worn out battery life. TRUST TECH to help make sure you're educated and equipped to take advantage of this service revenue opportunity. Tech carries a full line of TPMS sensors, service packs, workshop and diagnostic tools, and TPMS starter kits tailored to suit YOUR business.

Go directly to our web site:

www.techtpms.com

or click the TPMS links on
www.techtirerepairs.com

- **Access to on-line make, model & year sensor lookup**
- **Relearn charts for each model**
- **Download our Brochure**



"We turn this off"



TRUST TECH

TECH EUROPE

15 Ballinderry Road
Lisburn
Co. Antrim
BT28 2SA
Northern Ireland, U.K.
TEL: 44-2892-665721
FAX: 44-2892-601611
info@eurotyrerepair.com

TECH EUROPE BVBA

Bremheidelaan 6
2300 Turnhout
Belgium
TEL: 32-1-442-3103
FAX: 32-1-441-7003
Mobile: 32-4772-066-56
tech.europe@skynet.be

TECH MEXICO

MOBILE: 786-493-8260
rivera@techtirerepairs.com

**TECH INTERNATIONAL
(SHANGHAI) CO., LTD.**

1536 Rongle(E) Road
Songjiang Industrial Zone
Shanghai
P.R. China 201613
TEL: 86-21-5774-0748-3200
FAX: 86-21-5774-5560
www.tech-cn.com

NIPPON TECH, INC.

YCC Takanawa Bldg, 5F, 2-21-43
Takanawa, Minato-Ku
Tokyo 108-0074
Japan
TEL: 81-3-5462-7321
FAX: 81-3-5462-7323
www.tech-jp.co.jp

TECH CANADA

TEL: 647-526-0843
akhanna@techtirerepairs.com

TECH LATIN AMERICA

Av. Boyacá No. 55-63
Bogota D.C.
Colombia
TEL: 57-1-416-8666
FAX: 57-1-263-0689
www.techlatinamerica.com

TECH OCEANIA

67 B Munson St.
Mosman 2088
NSW Australia
TEL: 61-2-9969-1096
MOBILE: 61-4-1701-8625
www.tech-international.com

TECH ASIA PACIFIC

36th Floor, Menara Maxis
Kuala Lumpur City Centre
50088 Kuala Lumpur
Malaysia
TEL: 601-2319-4040
FAX: 603-5882-5680
francis.siaw@techtirerepairs.com

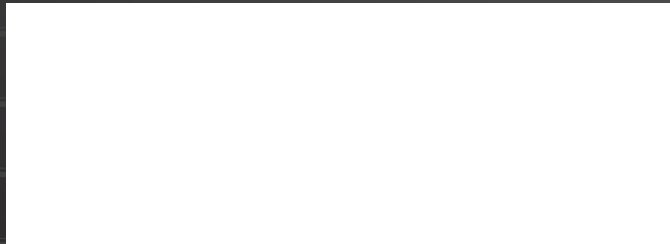
**TECH INTERNATIONAL**

200 East Coshocton Street
Johnstown, OH 43031
TEL: 740-967-9015
FAX: 740-967-1039
www.tech-international.com

