

TUBING, HOSES, & CLAMPS

- Air Brake Tubing
- Tubing Clamps & Clips
- Hose Spacers & Support Springs
- Air Brake Hose
- Air Brake Hose Assemblies
- Air Shift Transmission Hose
- Nose Box Hose Assemblies

- Slider Hose Assemblies
- Discharge Hose
- Cab Hoses & Accessories
- Tire Inflation Hose
- Brake Lines
- General Hose & Tubing
- Heater Hose

- Silicone Hose
- Connector Hose
- Hose Clamps
- Muffler Clamps
- Exhaust Clamps





AIR BRAKE TUBING

- Superior cold weather flexibility and abrasion resistance
- UV and ozone resistant nylon
- Conforms to our own rigorous qualification and inspection testing which exceed SAE & DOT requirements
- Designed to operate at up to 150 psi in air brake systems
- Resistant to exposure by gasoline, diesel fuel and commonly used road and cleaning chemicals
- Air Brake Tubing available on bulk spools or by using suffix for packages
- Operating range: -40°F- 200°F
- Not made for fuel
- Meets or exceeds SAEJ844 (Type A - non-reinforced & Type B - reinforced)
- Air Brake Tubing identified per SAE J844 & FMVSS No. 106 Brake Hoses, 49 CFR 571.106 Meets or exceeds DOT requirements for use with compression fittings

NOTE: SAE does not recognize 1/8", 5/32" or 3/16" O.D. tubing for use with air brake systems



AVAILABLE IN BAGS - 50 FT & 100 FT



AVAILABLE ON REELS - 250 FT+



TUBING REEL HUB

Part No. 08-P4122R
Stk. Code 99981

Hub is designed to reinforce the core of TECTRAN's corrugated spools which are used to house our air brake tubing

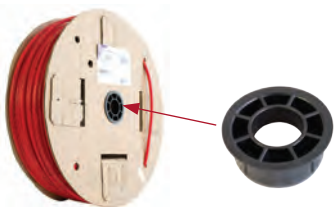

| Nominal O.D. | Nominal Wall | Color | Part No. | Stk. Code | Length | |
|--------------|--------------|-----------|-----------|-----------|---------|---------|
| 1/8" | 0.023" | Black | 1922-01 | 26001 | 2000 ft | |
| | | | 1922-01-1 | 26002 | 100 ft | |
| | | | 1922-01-T | 26003 | 50 ft | |
| 5/32" | 0.032" | Black | 19225-01 | 26008 | 1000 ft | |
| | | | 19225-011 | 26009 | 100 ft | |
| | | | 19225-01T | 26011 | 50 ft | |
| | | Blue | 19225-02 | 26391 | 1000 ft | |
| | | Green | 19225-04 | 26392 | 1000 ft | |
| Red | 19225-05 | 26390 | 1000 ft | | | |
| 3/16" | 0.035" | Black | 1923-01 | 26013 | 1000 ft | |
| | | | 1923-01-1 | 26014 | 100 ft | |
| | | | 1923-01-T | 26015 | 50 ft | |
| 1/4" | 0.040" | Black | 1924-01 | 26016 | 1000 ft | |
| | | | 1924-01-1 | 26017 | 100 ft | |
| | | | 1924-01-T | 26020 | 50 ft | |
| | | Blue | 1924-02 | 26021 | 1000 ft | |
| | | | 1924-02-1 | 26022 | 100 ft | |
| | | 1924-02-T | 26024 | 50 ft | | |
| | | Orange | 1924-03 | 26025 | 1000 ft | |
| | | | 1924-03-1 | 26026 | 100 ft | |
| | | | 1924-03-T | 26028 | 50 ft | |
| | | Green | 1924-04 | 26029 | 1000 ft | |
| | | | 1924-04-1 | 26030 | 100 ft | |
| | | | 1924-04-T | 26032 | 50 ft | |
| | | | Red | 1924-05 | 26033 | 1000 ft |
| | | | | 1924-05-1 | 26034 | 100 ft |
| 1924-05-T | 26036 | 50 ft | | | | |
| Yellow | 1924-07 | 26037 | 1000 ft | | | |
| | 1924-07-1 | 26038 | 100 ft | | | |
| | 1924-07-T | 26040 | 50 ft | | | |
| 5/16" | 0.040" | Black | 1925-01 | 26041 | 500 ft | |
| | | | 1925-01-1 | 26042 | 100 ft | |
| | | | 1925-01-T | 26043 | 50 ft | |
| 3/8" | 0.062" | Blue | 1926-01 | 26044 | 500 ft | |
| | | | 1926-01-1 | 26045 | 100 ft | |
| | | | 1926-01-T | 26049 | 50 ft | |
| | | | 1926-02 | 26050 | 500 ft | |
| | | | 1926-02-1 | 26051 | 100 ft | |
| | | | 1926-02-T | 26052 | 50 ft | |

AIR BRAKE TUBING

| Nominal O.D. | Nominal Wall | Color | Part No. | Stk. Code | Length | |
|--------------|--------------|--------|-----------|-----------|--------|--------|
| 3/8" | 0.062" | Orange | 1926-03 | 26053 | 500 ft | |
| | | | 1926-03-1 | 26054 | 100 ft | |
| | | | 1926-03-T | 26055 | 50 ft | |
| | | Green | 1926-04 | 26056 | 500 ft | |
| | | | 1926-04-1 | 26057 | 100 ft | |
| | | | 1926-04-T | 26058 | 50 ft | |
| | | Red | 1926-05 | 26059 | 500 ft | |
| | | | 1926-05-1 | 26060 | 100 ft | |
| | | | 1926-05-T | 26062 | 50 ft | |
| | | White | 1926-06-T | 26389 | 50 ft | |
| | | | Yellow | 1926-07 | 26063 | 500 ft |
| | | | | 1926-07-1 | 26064 | 100 ft |
| 1926-07-T | 26065 | 50 ft | | | | |
| 1/2" | 0.062" | Black | 1928-01 | 26068 | 500 ft | |
| | | | 1928-01-1 | 26069 | 100 ft | |
| | | | 1928-01-T | 26073 | 50 ft | |
| | | Blue | 1928-02 | 26074 | 500 ft | |
| | | | 1928-02-1 | 26075 | 100 ft | |
| | | | 1928-02-T | 26076 | 50 ft | |
| | | Orange | 1928-03 | 26077 | 500 ft | |
| | | | 1928-03-1 | 26078 | 100 ft | |
| | | | 1928-03-T | 26079 | 50 ft | |
| | | Green | 1928-04 | 26080 | 500 ft | |
| | | | 1928-04-1 | 26081 | 100 ft | |
| | | | 1928-04-T | 26082 | 50 ft | |
| | | Red | 1928-05 | 26083 | 500 ft | |
| | | | 1928-05-1 | 26084 | 100 ft | |
| | | | 1928-05-T | 26086 | 50 ft | |
| | | Yellow | 1928-07 | 26088 | 500 ft | |
| | | | 1928-07-1 | 26089 | 100 ft | |
| | | | 1928-07-T | 26090 | 50 ft | |
| 5/8" | 0.092" | Black | 1930-01 | 26095 | 250 ft | |
| | | | 1930-01-1 | 26096 | 100 ft | |
| | | | 1930-01-T | 26098 | 50 ft | |
| | | Green | 1930-04 | 26102 | 250 ft | |
| | | | 1930-04-1 | 26103 | 100 ft | |
| | | | 1930-04-T | 26104 | 50 ft | |
| | | Red | 1930-05 | 26105 | 250 ft | |
| | | | 1930-05-1 | 26106 | 100 ft | |
| | | | 1930-05-T | 26107 | 50 ft | |
| 3/4" | 0.092" | Black | 1932-01 | 26108 | 250 ft | |
| | | | 1932-01-1 | 26109 | 100 ft | |
| | | | 1932-01-T | 26110 | 50 ft | |
| | | Green | 1932-04 | 26386 | 250 ft | |
| | | | 1932-04-1 | 26387 | 100 ft | |
| | | | 1932-04-T | 26388 | 50 ft | |

NYLON TUBING REPAIR KIT

Part No. CAB28
Stk. Code 99097

Convenient kit contains 12" pieces of nylon tubing along with union fittings, a handy tube cutter, cable ties and tube clamps all in one place, providing everything needed for the repair of 1/8" through 5/8" OD nylon tubing.



HOSE & TUBE CUTTER

Part No. 5035
Stk. Code 51180



Part No. 5035-1
Stk. Code 51181



NYLON TUBING CUTTER

Part No. SC-1
Stk. Code 26111





AIR BRAKE FITTINGS

UNION



FERRULE

BRASS
PUSH-LOCK

COMPOSITE
PUSH-LOCK

| Tube Size | Part No. | Stk. Code | Part No. | Stk. Code | Part No. | Stk. Code |
|-----------|----------|-----------|----------|-----------|----------|-----------|
| 3/8" | 1362-6 | 85017 | PL1362-6 | 87036 | QL1362-6 | 87506 |
| 1/2" | 1362-8 | 85018 | PL1362-8 | 87037 | QL1362-8 | 87508 |

UNION TEE



FERRULE

BRASS
PUSH-LOCK

COMPOSITE
PUSH-LOCK

| Tube Size | Part No. | Stk. Code | Part No. | Stk. Code | Part No. | Stk. Code |
|-----------|----------|-----------|----------|-----------|----------|-----------|
| 3/8" | 1364-6 | 85025 | PL1364-6 | 87040 | QL1364-6 | 87515 |
| 1/2" | 1364-8 | 85027 | PL1364-8 | 87041 | QL1364-8 | 87517 |

MALE 45° ELBOW



FERRULE

BRASS
PUSH-LOCK

COMPOSITE
PUSH-LOCK

| Tube Size | Pipe Thd | Part No. | Stk. Code | Part No. | Stk. Code | Part No. | Stk. Code |
|-----------|----------|----------|-----------|-----------|-----------|-----------|-----------|
| 3/8" | 1/8" | 1374-6A | 85104 | PL1374-6A | 87131 | QL1374-6A | 85488 |
| 3/8" | 1/4" | 1374-6B | 85105 | PL1374-6B | 87105 | QL1374-6B | 87599 |
| 3/8" | 3/8" | 1374-6C | 85106 | PL1374-6C | 87106 | QL1374-6C | 87601 |
| 3/8" | 1/2" | 1374-6D | 85107 | PL1374-6D | 87122 | QL1374-6D | 87602 |
| 1/2" | 1/4" | 1374-8B | 85108 | PL1374-8B | 87137 | QL1374-8B | 87211 |
| 1/2" | 3/8" | 1374-8C | 85109 | PL1374-8C | 87121 | QL1374-8C | 87619 |
| 1/2" | 1/2" | 1374-8D | 85110 | PL1374-8D | 87132 | QL1374-8D | 87616 |
| 5/8" | 3/8" | 1374-10C | 87199 | - | - | QL137410C | 87615 |
| 5/8" | 1/2" | 1374-10D | 85101 | PL137410D | 87102 | QL137410D | 87603 |
| 3/4" | 1/2" | 1374-12D | 85260 | - | - | QL137412D | 87212 |

MALE 90° ELBOW



FERRULE

BRASS
PUSH-LOCK

COMPOSITE
PUSH-LOCK

| Tube Size | Pipe Thrd | Part No. | Stk. Code | Part No. | Stk. Code | Part No. | Stk. Code |
|-----------|-----------|----------|-----------|-----------|-----------|-----------|-----------|
| 1/4" | 3/8" | 1369-4C | 85070 | PL1369-4C | 87078 | QL1369-4C | 87561 |
| 3/8" | 1/8" | 1369-6A | 85071 | PL1369-6A | 87079 | QL1369-6A | 87562 |
| 3/8" | 1/4" | 1369-6B | 85072 | PL1369-6B | 87080 | QL1369-6B | 87564 |
| 3/8" | 3/8" | 1369-6C | 85073 | PL1369-6C | 87081 | QL1369-6C | 87566 |
| 3/8" | 1/2" | 1369-6D | 85074 | PL1369-6D | 87082 | QL1369-6D | 87568 |
| 1/2" | 1/4" | 1369-8B | 85075 | PL1369-8B | 87083 | QL1369-8B | 87569 |
| 1/2" | 3/8" | 1369-8C | 85076 | PL1369-8C | 87084 | QL1369-8C | 87570 |
| 1/2" | 1/2" | 1369-8D | 85077 | PL1369-8D | 87085 | QL1369-8D | 87572 |
| 5/8" | 3/8" | 1369-10C | 85063 | PL136910C | 87070 | QL136910C | 87573 |
| 5/8" | 1/2" | 1369-10D | 85064 | PL136910D | 87071 | QL136910D | 87574 |
| 3/4" | 1/2" | 1369-12D | 85066 | PL136912D | 85453 | QL136912D | 85469 |

MALE RUN TEE



FERRULE

BRASS
PUSH-LOCK

COMPOSITE
PUSH-LOCK

| Tube Size | Pipe Thrd | Part No. | Stk. Code | Part No. | Stk. Code | Part No. | Stk. Code |
|-----------|-----------|----------|-----------|-----------|-----------|-----------|-----------|
| 3/8" | 1/4" | 1371-6B | 85089 | PL1371-6B | 87092 | QL1371-6B | 87581 |
| 3/8" | 3/8" | 1371-6C | 85090 | PL1371-6C | 87093 | QL1371-6C | 87582 |
| 1/2" | 1/4" | 1371-8B | 90175 | - | - | QL1371-8B | 85484 |
| 1/2" | 3/8" | 1371-8C | 85091 | PL1371-8C | 87094 | QL1371-8C | 87583 |
| 1/2" | 1/2" | 1371-8D | 85092 | PL1371-8D | 87129 | QL1371-8D | 87645 |
| 5/8" | 1/2" | 1371-10D | 85086 | - | - | QL137110D | 87646 |

FULL BRASS PRODUCT LINE CAN BE FOUND IN THE FITTINGS SECTION OF THIS CATALOG, OR ON OUR WEBSITE www.TECTRAN.com

MALE BRANCH TEE



FERRULE

BRASS
PUSH-LOCK

COMPOSITE
PUSH-LOCK

| Tube Size | Pipe Thd | Part No. | Stk. Code | Part No. | Stk. Code | Part No. | Stk. Code |
|-----------|----------|----------|-----------|-----------|-----------|-----------|-----------|
| 3/8" | 1/8" | 1372-6A | 85096 | PL1372-6A | 87130 | QL1372-6A | 85486 |
| 3/8" | 1/4" | 1372-6B | 85097 | PL1372-6B | 87098 | QL1372-6B | 87589 |
| 3/8" | 3/8" | 1372-6C | 85098 | PL1372-6C | 87099 | QL1372-6C | 87591 |
| 1/2" | 1/4" | 1372-8B | 85344 | PL1372-8B | 89910 | QL1372-8B | 85487 |
| 1/2" | 3/8" | 1372-8C | 85099 | PL1372-8C | 87100 | QL1372-8C | 87593 |
| 1/2" | 1/2" | 1372-8D | 85100 | PL1372-8D | 87101 | QL1372-8D | 87648 |
| 5/8" | 1/2" | 1372-10D | 85093 | - | - | QL137210D | 87649 |

MALE CONNECTOR



FERRULE

BRASS
PUSH-LOCK

COMPOSITE
PUSH-LOCK

| Tube Size | Pipe Thd | Part No. | Stk. Code | Part No. | Stk. Code | Part No. | Stk. Code |
|-----------|----------|----------|-----------|-----------|-----------|-----------|-----------|
| 1/4" | 3/8" | 1368-4C | 85051 | PL1368-4C | 87062 | QL1368-4C | 87537 |
| 3/8" | 1/8" | 1368-6A | 85052 | PL1368-6A | 87063 | QL1368-6A | 87539 |
| 3/8" | 1/4" | 1368-6B | 85053 | PL1368-6B | 87064 | QL1368-6B | 87541 |
| 3/8" | 3/8" | 1368-6C | 85054 | PL1368-6C | 87065 | QL1368-6C | 87543 |
| 3/8" | 1/2" | 1368-6D | 85055 | PL1368-6D | 87066 | QL1368-6D | 87545 |
| 1/2" | 1/4" | 1368-8B | 85056 | PL1368-8B | 87067 | QL1368-8B | 87546 |
| 1/2" | 3/8" | 1368-8C | 85057 | PL1368-8C | 87068 | QL1368-8C | 87548 |
| 1/2" | 1/2" | 1368-8D | 85058 | PL1368-8D | 87069 | QL1368-8D | 87550 |
| 1/2" | 3/4" | 1368-8E | 85059 | - | - | QL1368-8E | 85475 |
| 5/8" | 3/8" | 1368-10C | 85043 | PL136810C | 87050 | QL136810C | 87552 |
| 5/8" | 1/2" | 1368-10D | 85044 | PL136810D | 87051 | QL136810D | 87553 |
| 3/4" | 1/2" | 1368-12D | 85047 | PL136812D | 87052 | QL136812D | 87215 |

BULK HEAD UNION



FERRULE

BRASS
PUSH-LOCK

COMPOSITE
PUSH-LOCK

| Tube Size | Part No. | Stk. Code | Part No. | Stk. Code | Part No. | Stk. Code |
|-----------|----------|-----------|----------|-----------|----------|-----------|
| 3/8" | 1377-6 | 85112 | PL1377-6 | 87110 | QL1377-6 | 87605 |
| 1/2" | 1377-8 | 85113 | PL1377-8 | 87111 | QL1377-8 | 87606 |

TUBE CLAMPS & CLIPS

RUBBER COVERED



| Clamping Diameter | 5/8" Wide Part No. | Stk. Code | Mounting Screw | 1/2" Wide Part No. | Stk. Code | Mounting Screw |
|-------------------|--------------------|-----------|----------------|--------------------|-----------|----------------|
| 3/16" | 900R | 46463 | 3/8" | 900RA | 46454 | 1/4" |
| 1/4" | 901R | 46017 | 3/8" | 901RA | 46018 | 1/4" |
| 5/16" | 902R | 46464 | 3/8" | 902RA | 46455 | 1/4" |
| 3/8" | 903R | 46028 | 3/8" | 903RA | 46029 | 1/4" |
| 7/16" | 903R-716 | 46465 | 3/8" | 903RA-716 | 46456 | 1/4" |
| 1/2" | 904R | 46036 | 3/8" | 904RA | 46037 | 1/4" |
| 9/16" | 904R-916 | 46466 | 3/8" | 904RA-916 | 46457 | 1/4" |
| 5/8" | 905R | 46044 | 3/8" | 905RA | 46045 | 1/4" |
| 3/4" | 906R | 46051 | 3/8" | 906RA | 46052 | 1/4" |
| 7/8" | 906R-78 | 46467 | 3/8" | 906RA-78 | 46458 | 1/4" |
| 1" | 907R | 46058 | 3/8" | 907RA | 46059 | 1/4" |
| 1 1/8" | 907R-118 | 46468 | 3/8" | 908RA | 46459 | 1/4" |
| 1 1/4" | 908R | 46063 | 3/8" | 909RA | 46460 | 1/4" |
| 1 3/8" | 909R | 46469 | 3/8" | 910RA | 46461 | 1/4" |
| 1 7/16" | 911R | 46470 | 3/8" | 911RA | 46462 | 1/4" |
| 1 1/2" | 900R-24 | 46001 | 3/8" | - | - | - |
| 2" | 900R-32 | 46003 | 3/8" | - | - | - |
| 2 1/2" | 900R-40 | 46005 | 3/8" | - | - | - |
| 3" | 900R-48 | 46007 | 3/8" | - | - | - |
| 4" | 900R-64 | 46008 | 3/8" | - | - | - |
| 4 1/2" | 900R-72 | 46009 | 3/8" | - | - | - |
| 5" | 900R-80 | 46010 | 3/8" | - | - | - |

PLASTISOL DIPPED



| Clamping Diameter | Part No. | Stk. Code | Mounting Screw |
|-------------------|----------|-----------|----------------|
| 1/4" | 901 | 46013 | 1/4" |
| 5/16" | 902 | 46022 | 1/4" |
| 3/8" | 903 | 46024 | 1/4" |
| 1/2" | 904 | 46033 | 1/4" |
| 5/8" | 905 | 46041 | 1/4" |
| 3/4" | 906 | 46049 | 5/16" |
| 1" | 907 | 46056 | 5/16" |
| 1 1/4" | 908 | 46062 | 5/16" |

NYLON

- #10 mounting screw



| Clamping Diameter | White Part No. | Stk. Code | Black Part No. | Stk. Code |
|-------------------|----------------|-----------|----------------|-----------|
| 1/4" | 901N | 46014 | 901NB | 46015 |
| 5/16" | 902N | 46023 | 902NB | 46447 |
| 3/8" | 903N | 46025 | 903NB | 46026 |
| 1/2" | 904N | 46034 | 904NB | 46035 |
| 5/8" | 905N | 46042 | 905NB | 46043 |
| 3/4" | 906N | 46050 | - | - |
| 1" | 907N | 46057 | - | - |



TUBE CLAMPS & CLIPS

FRAME CLIPS - ZINC PLATED



| Clamping Diameter | Part No. | Stk. Code | Mounting Screw |
|-------------------|----------|-----------|----------------|
| 1/4" | 930-4 | 46075 | #10 |
| 3/8" | 930-6 | 46076 | #10 |
| 1/2" | 930-8 | 46077 | #10 |
| 5/8" | 930-10 | 46071 | 1/4" |
| 3/4" | 930-12 | 46073 | 1/4" |
| 1" | 930-16 | 46074 | 1/4" |

FRAME CLIPS

Part No. 920-F3
Stk. Code 46067
 1/2"W x 1 1/2" L
 Panel Thickness - 1/8" - 5/16"
 Dia. Range - 1/8 - 3/8"



Part No. 920-F4
Stk. Code 46069
 1/2"W x 1 1/2" L
 Panel Thickness - 1/8" - 3/16"
 Dia. Range - 1/8" - 1/4"



BEAM CLIP

Part No. 94-0108
Stk. Code 47129



ABS SENSOR TO HOSE CLIP



| Part No. | Stk. Code | Sensor Cable Dia. |
|----------|-----------|-------------------|
| 940-49 | 47131 | .180" |
| 940-50 | 47203 | .250" |

HOSE SPACERS

- Made of high-impact nylon
- Can be mounted by means of a cable tie or suspended from a hose support spring



Part No. 940-5
Stk. Code 47075



Part No. 940-52
Stk. Code 47076



Part No. 940-585
Stk. Code 47188

| Part No. | Stk. Code | Description |
|----------|-----------|---------------------------------|
| 940-5 | 47075 | Two - 3/8" I.D hoses |
| 940-52 | 47076 | Four - 3/8" I.D hoses |
| 940-58 | 47077 | Two - 1/2" I.D. hoses |
| 940-582 | 47078 | Four - 1/2" I.D. hoses |
| 940-584 | 47231 | 3/8" I.D. hose & 1/4" I.D. hose |
| 940-585 | 47188 | 1/2" I.D. hose & 3/8" I.D. hose |

HOSE SUPPORT SPRINGS

- Springs have double-looped ends for easy attachment and to prevent opening
- Springs are plated for corrosion protection



| Part No. | Stk. Code | Length | O.D. | Application |
|----------|-----------|---------|---------|-------------------------------------|
| 915 | 47273 | 8" | 1 1/8" | Heavy duty |
| 916 | 47325 | 11" | 1" | Heavy duty |
| 911 | 47002 | 13" | 3/4" | Regular duty |
| 912 | 47004 | 13" | 1" | Heavy duty |
| 913 | 47006 | 16" | 1 1/16" | Extra heavy duty |
| 910U | 47224 | 24" | 1 1/8" | Heavy duty (undercarriage) |
| 910 | 47001 | 25 1/2" | 1 1/8" | Extra heavy duty (for hookup lines) |
| 914 | 47142 | 25 1/2" | 1 5/16" | Super duty (hydraulic grade) |



AIR BRAKE HOSE

- The uniform design consists of interwoven spirals providing greater flexibility and improved twist resistance compared to other spiral designs
- Layers of the hose wall are fully bonded to enhance kink resistance, enabling tighter bends
- The rugged elastomeric hose cover is resistant to gasoline, diesel fuel, oil and commonly used road and cleaning chemicals
- The hose cover may be perforated in some sizes to allow moisture to escape from the reinforcement layer
- UV and ozone resistant
- Designed for operating pressures up to 225 psi
- Operating temperature of -40°F to +200°F (-40°C to +93°C)
- Designed to provide flexible air-connection from frame to axle or between tractor and trailer where exposed to flexing, pulling or impact
- Suitable for use with factory-assembled, permanently attached fittings or with field-attachable, reusable fittings
- Meets or exceeds SAE J1402 - Type A
- Meets or exceeds DOT FMVSS No. 106 - Brake Hoses, 49 CFR 571.106
- Consult our complete Brass section of this catalog for a wide range of compatible end-fittings.



BLACK HOSE

| Part No. | Stk. Code | Nominal I.D. | Nominal O.D. | Working Pressure | Min. Bend Radius | Length |
|----------|-----------|--------------|--------------|------------------|------------------|---------------|
| 1921-4-T | 21414 | 1/4" | 5/8" | 225 | 2 1/2" | 50 ft Carton |
| 1921-6 | 21415 | 3/8" | 3/4" | 225 | 3 1/2" | 250 ft Spool |
| 1921-6-1 | 21416 | 3/8" | 3/4" | 225 | 3 1/2" | 100 ft Carton |
| 1921-6-T | 21418 | 3/8" | 3/4" | 225 | 3 1/2" | 50 ft Carton |
| 1921-8 | 21419 | 1/2" | 7/8" | 225 | 4" | 250 ft Spool |
| 1921-8-1 | 21420 | 1/2" | 7/8" | 225 | 4" | 100 ft Carton |
| 1921-8-T | 21422 | 1/2" | 7/8" | 225 | 4" | 50 ft Carton |

The values listed under "Minimum Bend Radius" are SAE recommended minimums. The fully-bonded Tectran hose is capable of tighter bends in certain circumstances. Please consult the factory for application suggestions.

RED/BLUE HOSE

- Color-coded hose helps minimize incorrect tractor/trailer connections



| Part No. | Stk. Code | Nominal I.D. | Nominal O.D. | Working Pressure | Min. Bend Radius | Length | Color |
|----------|-----------|--------------|--------------|------------------|------------------|---------------|-------|
| 13HB6-1 | 22339 | 3/8" | 3/4" | 225 | 3 1/2" | 100 ft Carton | Blue |
| 13HB6-T | 22340 | 3/8" | 3/4" | 225 | 3 1/2" | 50 ft Carton | Blue |
| 13HR6-1 | 22341 | 3/8" | 3/4" | 225 | 3 1/2" | 100 ft Carton | Red |
| 13HR6-T | 22342 | 3/8" | 3/4" | 225 | 3 1/2" | 50 ft Carton | Red |

ARTICFLEX HOSE

- Cold temperature performance air brake hose
- Rated at -65°F
- Meets SAE J1402 Type A
- Meets or exceeds DOT FMVSS No. 106 - Brake Hoses, 49 CFR 571.106



| Part No. | Stk. Code | Hose I.D. | Length |
|-----------|-----------|-----------|---------------|
| 1921A-6 | 21423 | 3/8" | 250 ft Spool |
| 1921A-6-1 | 21424 | 3/8" | 100 ft Carton |
| 1921A-6-T | 21426 | 3/8" | 50 ft Carton |
| 1921A-8 | 21427 | 1/2" | 250 ft Spool |
| 1921A-8-1 | 21460 | 1/2" | 100 ft Carton |
| 1921A-8-T | 21461 | 1/2" | 50 ft Carton |

REUSABLE HOSE FITTINGS

FULL BRASS PRODUCT LINE CAN BE FOUND IN THE FITTINGS SECTION OF THIS CATALOG, OR ON OUR WEBSITE www.TECTRAN.com

ASSEMBLY (W/ SPRING GUARD) - D.O.T



| Part No. | Stk. Code | I.D./ Hose Size | Pipe Thread |
|----------|-----------|-----------------|-------------|
| 102 | 84001 | 3/8 | 1/4 |
| 103 | 84014 | 3/8 | 3/8 |
| 104 | 84019 | 3/8 | 1/2 |
| 103-8 | 84017 | 1/2 | 3/8 |
| 104-8 | 84022 | 1/2 | 1/2 |

SPRING

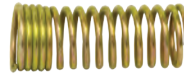

| Part No. | Stk. Code | I.D./ Hose Size |
|----------|-----------|-----------------|
| 1024 | 84009 | 3/8 |
| 1024-8 | 84010 | 1/2 |

ASSEMBLY (W/O SPRING GUARD) - D.O.T



| Part No. | Stk. Code | I.D./ Hose Size | Pipe Thread |
|----------|-----------|-----------------|-------------|
| 105 | 84024 | 3/8 | 1/4 |
| 106 | 84027 | 3/8 | 3/8 |
| 107 | 84030 | 3/8 | 1/2 |
| 106-8 | 84028 | 1/2 | 3/8 |
| 107-8 | 84033 | 1/2 | 1/2 |

FERRULE



| Part No. | Stk. Code | I.D./ Hose Size |
|----------|-----------|-----------------|
| 1022 | 84003 | 3/8 |
| 1022-8 | 84004 | 1/2 |

HOSE END KITS

- For 3/8" ID J1402 type A, AI and All hose with a minimum of 3/4" O.D.

FIX-IT PACK



BAG OF 10



BOX OF 100



| Part No. | Stk. Code | Thread | Description |
|-----------|-----------|---------|---|
| 70-31402 | 34274 | 3/8 NPT | FIX-IT Pack - includes 2 Swivel Ends & 1 Hex Wrench |
| 70-31403 | 34275 | 1/2 NPT | FIX-IT Pack - includes 2 Swivel Ends & 1 Hex Wrench |
| 70-31404 | 34461 | 3/8 NPT | Bag of 10 Swivel Ends & 1 Hex Wrench |
| 70-31405 | 34462 | 1/2 NPT | Bag of 10 Swivel Ends & 1 Hex Wrench |
| 70-31406 | 35710 | 3/8 NPT | Case of 5 - 3/8 FIX-IT Packs |
| 70-31407 | 35711 | 1/2 NPT | Case of 5 - 1/2 FIX-IT Packs |
| 70-31408* | 34463 | 3/8 NPT | Box of 100 Swivel Ends |
| 70-31409* | 34464 | 1/2 NPT | Box of 100 Swivel Ends |
| 70-31422 | 35622 | 3/8 NPT | FIX-IT Pack - includes 2 Swivel Ends & 1 Hex Wrench & 2 Springs |

* NOTE: Hex wrench not included

TEFLON PIPE TAPE

Part No. TT1/2
Stk. Code 88617

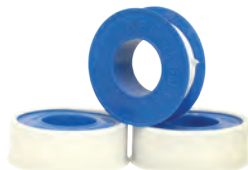



DUAL LIFESWIVEL™ AIR BRAKE HOSE ASSEMBLIES

BLACK HOSE



- **LIFESwivel™** - a live swivel design featuring all brass construction to eliminate corrosion
- **LIFESwivel™** ends allow for movement without binding
- Double O-ring leak free "life" design
- Barbed hose inserts on both ends provide added durability when crimped
- Quick & easy single wrench installs
- Rugged hose construction resistant to UV, ozone, fuels, and other commonly used road chemicals
- Operating temperature: -40°F to 200°F
- Meets or exceeds SAE J1402 - Type A - DOT FMVSS - No. 106 Brake Hoses, 49 CFR 571.10

Cross section of **LIFESwivel™** fitting

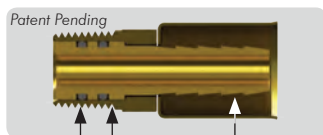

Double O-ring seal

Barbed hose inserts on both ends when crimped provide added durability



Dual Swivel Ends

| Length | 3/8" HOSE I.D. | | | | 1/2" HOSE I.D. | |
|--------|---------------------------|-----------|---------------------------|-----------|---------------------------|-----------|
| | Dual 3/8" LIFESwivel Ends | | Dual 1/2" LIFESwivel Ends | | Dual 3/8" LIFESwivel Ends | |
| | Part No. | Stk. Code | Part No. | Stk. Code | Part No. | Stk. Code |
| 16" | 651666 | 21761 | 651688 | 22781 | 681666 | 22833 |
| 18" | 651866 | 22451 | 651888 | 22782 | 681866 | 22834 |
| 20" | 652066 | 21762 | 652088 | 22783 | 682066 | 22835 |
| 22" | 652266 | 21763 | 652288 | 22784 | 682266 | 22836 |
| 24" | 652466 | 21764 | 652488 | 22785 | 682466 | 22837 |
| 26" | 652666 | 21765 | 652688 | 22786 | 682666 | 22838 |
| 28" | 652866 | 21766 | 652888 | 22787 | 682866 | 22839 |
| 30" | 653066 | 21767 | 653088 | 22788 | 683066 | 22840 |
| 32" | 653266 | 21768 | 653288 | 22789 | 683266 | 22841 |
| 34" | 653466 | 21769 | 653488 | 22790 | 683466 | 22842 |
| 36" | 653666 | 21770 | 653688 | 22791 | 683666 | 22843 |
| 38" | 653866 | 21771 | 653888 | 22792 | 683866 | 22844 |
| 40" | 654066 | 21772 | 654088 | 22793 | 684066 | 22845 |
| 42" | 654266 | 21773 | 654288 | 22794 | 684266 | 22846 |
| 44" | 654466 | 21774 | 654488 | 22795 | 684466 | 22847 |
| 46" | 654666 | 22512 | 654688 | 22796 | 684666 | 22848 |
| 48" | 654866 | 21775 | 654888 | 22797 | 684866 | 22849 |
| 50" | 655066 | 21776 | 655088 | 22798 | 685066 | 22850 |
| 52" | 655266 | 22472 | 655288 | 22799 | 685266 | 22851 |
| 54" | 655466 | 22861 | 655488 | 22912 | 685466 | 22897 |
| 56" | 655666 | 23073 | 655688 | 23074 | 685666 | 22875 |
| 58" | 655866 | 22473 | 655888 | 22800 | 685866 | 22852 |
| 60" | 656066 | 21777 | 656088 | 22801 | 686066 | 22853 |
| 72" | 657266 | 22913 | 657288 | 23075 | 687266 | 22876 |
| 84" | 658466 | 22914 | 658488 | 23076 | 688466 | 22877 |

For Lengths not listed in chart, or assemblies with sealant applied, consult price list. Contact Tectran for other end configurations.

For complete Tectran Patent & Trademark information, see www.tectran.com/patents

DUAL LIFESWIVEL™ AIR BRAKE HOSE ASSEMBLIES

RED/BLUE HOSE

- **LIFESwivel™** - a live swivel design featuring all brass construction to eliminate corrosion
- **LIFESwivel™** ends allow for movement without binding
- Double O-ring leak free "life" design
- Barbed hose inserts on both ends provide added durability when crimped
- Quick & easy single wrench installs
- Rugged hose construction resistant to UV, ozone, fuels, and other commonly used road chemicals
- Operating temperature: -40°F to 200°F
- Meets or exceeds SAE J1402 - Type A - DOT FMVSS - No. 106 Brake Hoses, 49 CFR 571.10

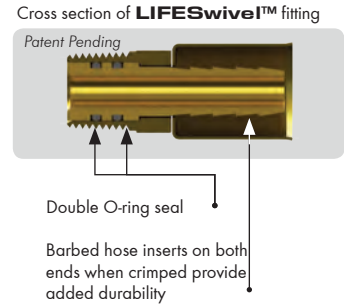
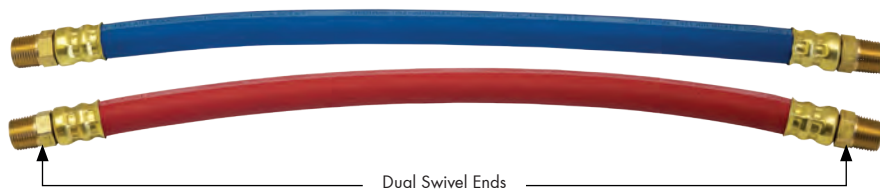

| Length | RED HOSE | | | | | | BLUE HOSE | | | | | |
|--------|---------------------------|---------------------------|---------------------------|---------------------------|---------------------------|---------------------------|---------------------------|---------------------------|---------------------------|---------------------------|---------------------------|---------------------------|
| | 3/8" HOSE I.D. | | 1/2" HOSE I.D. | | 3/8" HOSE I.D. | | 1/2" HOSE I.D. | | 3/8" HOSE I.D. | | 1/2" HOSE I.D. | |
| | Dual 3/8" LIFESwivel Ends | Dual 1/2" LIFESwivel Ends | Dual 3/8" LIFESwivel Ends | Dual 1/2" LIFESwivel Ends | Dual 3/8" LIFESwivel Ends | Dual 1/2" LIFESwivel Ends | Dual 3/8" LIFESwivel Ends | Dual 1/2" LIFESwivel Ends | Dual 3/8" LIFESwivel Ends | Dual 1/2" LIFESwivel Ends | Dual 3/8" LIFESwivel Ends | Dual 1/2" LIFESwivel Ends |
| | Part No. | Stk. Code | Part No. | Stk. Code | Part No. | Stk. Code | Part No. | Stk. Code | Part No. | Stk. Code | Part No. | Stk. Code |
| 16" | 13R61666 | 22599 | 13R61688 | 22651 | 13R81666 | 22703 | 13B61666 | 22573 | 13B61688 | 22625 | 13B81666 | 22677 |
| 18" | 13R61866 | 22600 | 13R61888 | 22652 | 13R81866 | 22704 | 13B61866 | 22574 | 13B61888 | 22626 | 13B81866 | 22678 |
| 20" | 13R62066 | 22601 | 13R62088 | 22653 | 13R82066 | 22705 | 13B62066 | 22575 | 13B62088 | 22627 | 13B82066 | 22679 |
| 22" | 13R62266 | 22602 | 13R62288 | 22654 | 13R82266 | 22706 | 13B62266 | 22576 | 13B62288 | 22628 | 13B82266 | 22680 |
| 24" | 13R62466 | 22603 | 13R62488 | 22655 | 13R82466 | 22707 | 13B62466 | 22577 | 13B62488 | 22629 | 13B82466 | 22681 |
| 26" | 13R62666 | 22604 | 13R62688 | 22656 | 13R82666 | 22708 | 13B62666 | 22578 | 13B62688 | 22630 | 13B82666 | 22682 |
| 28" | 13R62866 | 22605 | 13R62888 | 22657 | 13R82866 | 22709 | 13B62866 | 22579 | 13B62888 | 22631 | 13B82866 | 22683 |
| 30" | 13R63066 | 22606 | 13R63088 | 22658 | 13R83066 | 22710 | 13B63066 | 22580 | 13B63088 | 22632 | 13B83066 | 22684 |
| 32" | 13R63266 | 22607 | 13R63288 | 22659 | 13R83266 | 22711 | 13B63266 | 22581 | 13B63288 | 22633 | 13B83266 | 22685 |
| 34" | 13R63466 | 22608 | 13R63488 | 22660 | 13R83466 | 22712 | 13B63466 | 22582 | 13B63488 | 22634 | 13B83466 | 22686 |
| 36" | 13R63666 | 22609 | 13R63688 | 22661 | 13R83666 | 22713 | 13B63666 | 22583 | 13B63688 | 22635 | 13B83666 | 22687 |
| 38" | 13R63866 | 22610 | 13R63888 | 22662 | 13R83866 | 22714 | 13B63866 | 22584 | 13B63888 | 22636 | 13B83866 | 22688 |
| 40" | 13R64066 | 22611 | 13R64088 | 22663 | 13R84066 | 22715 | 13B64066 | 22585 | 13B64088 | 22637 | 13B84066 | 22689 |
| 42" | 13R64266 | 22612 | 13R64288 | 22664 | 13R84266 | 22716 | 13B64266 | 22586 | 13B64288 | 22638 | 13B84266 | 22690 |
| 44" | 13R64466 | 22613 | 13R64488 | 22665 | 13R84466 | 22717 | 13B64466 | 22587 | 13B64488 | 22639 | 13B84466 | 22691 |
| 46" | 13R64666 | 22614 | 13R64688 | 22666 | 13R84666 | 22718 | 13B64666 | 22588 | 13B64688 | 22640 | 13B84666 | 22692 |
| 48" | 13R64866 | 22615 | 13R64888 | 22667 | 13R84866 | 22719 | 13B64866 | 22589 | 13B64888 | 22641 | 13B84866 | 22693 |
| 50" | 13R65066 | 22616 | 13R65088 | 22668 | 13R85066 | 22720 | 13B65066 | 22590 | 13B65088 | 22642 | 13B85066 | 22694 |
| 52" | 13R65266 | 22617 | 13R65288 | 22669 | 13R85266 | 22721 | 13B65266 | 22591 | 13B65288 | 22643 | 13B85266 | 22695 |
| 54" | 13R65466 | 22919 | 13R65488 | 23213 | 13R85466 | 22922 | 13B65466 | 23083 | 13B65488 | 23085 | 13B85466 | 22917 |
| 56" | 13R65666 | 23077 | 13R65688 | 23078 | 13R85666 | 23081 | 13B65666 | 23084 | 13B65688 | 23086 | 13B85666 | 23087 |
| 58" | 13R65866 | 22618 | 13R65888 | 22670 | 13R85866 | 22722 | 13B65866 | 22592 | 13B65888 | 22644 | 13B85866 | 22696 |
| 60" | 13R66066 | 22619 | 13R66088 | 22671 | 13R86066 | 22723 | 13B66066 | 22593 | 13B66088 | 22645 | 13B86066 | 22697 |
| 72" | 13R67266 | 22920 | 13R67288 | 23079 | 13R87266 | 22923 | 13B67266 | 22915 | 13B67288 | 23162 | 13B87266 | 22918 |
| 84" | 13R68466 | 22921 | 13R68488 | 23080 | 13R88466 | 23082 | 13B68466 | 22924 | 13B68488 | 23163 | 13B88466 | 23164 |

For Lengths not listed in chart, or assemblies with sealant applied, consult price list. Contact Tectran for other end configurations.



AIR BRAKE HOSE ASSEMBLIES

SINGLE SWIVEL END

- Rugged hose construction resistant to UV, ozone, fuels, and other commonly used road chemicals
- Operating temperature: -40 °F to 200 °F
- Meets or exceeds SAE J1402 - Type A - DOT FMVSS No. 106 - Brake Hoses, 49 CFR 571.106
- Available from stock in a wide selection of lengths and end-configurations



Single Swivel End

| Length | 3/8" HOSE I.D. | | | | 1/2" HOSE I.D. | | | |
|--------|--------------------------|-----------|--------------------------|-----------|--------------------------|-----------|--------------------------|-----------|
| | 1/4" Fixed x 1/4" Swivel | | 3/8" Fixed x 3/8" Swivel | | 3/8" Fixed x 3/8" Swivel | | 3/8" Fixed x 1/2" Swivel | |
| | Part No. | Stk. Code | Part No. | Stk. Code | Part No. | Stk. Code | Part No. | Stk. Code |
| 16" | 16116 | 21030 | 16116-66 | 21031 | 18116 | 21263 | 18116-68 | 23066 |
| 18" | 16118 | 21033 | 16118-66 | 21034 | 18118 | 21264 | 18118-68 | 21266 |
| 20" | 16120 | 21040 | 16120-66 | 21042 | 18120 | 21269 | 18120-68 | 21270 |
| 22" | 16122 | 21045 | 16122-66 | 21046 | 18122 | 21272 | 18122-68 | 21273 |
| 24" | 16124 | 21049 | 16124-66 | 21051 | 18124 | 21276 | 18124-68 | 21278 |
| 26" | 16126 | 21055 | 16126-66 | 21056 | 18126 | 21283 | 18126-68 | 21284 |
| 28" | 16128 | 21059 | 16128-66 | 21061 | 18128 | 21286 | 18128-68 | 21287 |
| 30" | 16130 | 21064 | 16130-66 | 21065 | 18130 | 21289 | 18130-68 | 21290 |
| 32" | 16132 | 21068 | 16132-66 | 21069 | 18132 | 21293 | 18132-68 | 21294 |
| 34" | 16134 | 21072 | 16134-66 | 21073 | 18134 | 21296 | 18134-68 | 21297 |
| 36" | 16136 | 21076 | 16136-66 | 21079 | 18136 | 21299 | 18136-68 | 21300 |
| 38" | 16138 | 21082 | 16138-66 | 21083 | 18138 | 21302 | 18138-68 | 21303 |
| 40" | 16140 | 21086 | 16140-66 | 21087 | 18140 | 21305 | 18140-68 | 21306 |
| 42" | 16142 | 21090 | 16142-66 | 21092 | 18142 | 21308 | 18142-68 | 21309 |
| 44" | 16144 | 21160 | 16144-66 | 21095 | 18144 | 21311 | 18144-68 | 21312 |
| 46" | 16146 | 21098 | 16146-66 | 21099 | 18146 | 21314 | 18146-68 | 21315 |
| 48" | 16148 | 21102 | 16148-66 | 21104 | 18148 | 21317 | 18148-68 | 21318 |
| 50" | 16150 | 21166 | 16150-66 | 21168 | 18150 | 21320 | 18150-68 | 21321 |
| 52" | 16152 | 21173 | 16152-66 | 21177 | 18152 | 21323 | 18152-68 | 21324 |
| 54" | 16154 | 21109 | 16154-66 | 21111 | 18154 | 21326 | 18154-68 | 21327 |
| 56" | 16156 | 21180 | 16156-66 | 21113 | 18156 | 21329 | 18156-68 | 21330 |
| 58" | 16158 | 21115 | 16158-66 | 21480 | 18158 | 21332 | 18158-68 | 21333 |
| 60" | 16160 | 21116 | 16160-66 | 21118 | 18160 | 21334 | 18160-68 | 21335 |
| 72" | 16172 | 21133 | 16172-66 | 21135 | 18172 | 21349 | 18172-68 | 21350 |
| 84" | 16184 | 22143 | 16184-66 | 21145 | 18184 | 21361 | 18184-68 | 21362 |

For Lengths not listed in chart, or assemblies with sealant applied, consult price list. Contact Tectran for other end configurations.

AIR BRAKE HOSE ASSEMBLIES

DUAL SWIVEL ENDS

- Provides the convenience of a second swivel fitting making installation much easier
- Heavy duty metal to metal seal
- Removable adapters allow for easy conversion to various port sizes
- Rugged hose construction resistant to UV, ozone, fuels, and other commonly used road chemicals
- Operating temperature: -40°F to 200°F
- Meets or exceeds SAE J1402 - Type A - DOT FMVSS No. 106 - Brake Hoses, 49 CFR 571.106
- Available from stock in a wide selection of lengths and end-configurations



| Length | 3/8" HOSE I.D. | | | | 1/2" HOSE I.D. | |
|--------|-----------------------|-----------|-----------------------|-----------|-----------------------|-----------|
| | Dual 1/4" Swivel Ends | | Dual 3/8" Swivel Ends | | Dual 3/8" Swivel Ends | |
| | Part No. | Stk. Code | Part No. | Stk. Code | Part No. | Stk. Code |
| 16" | 161SW16 | 23067 | 161SW1666 | 21163 | 181SW16 | 21369 |
| 18" | 161SW18 | 21164 | 161SW1866 | 21165 | 181SW18 | 21370 |
| 20" | 161SW20 | 22178 | 161SW2066 | 21167 | 181SW20 | 21371 |
| 22" | 161SW22 | 21169 | 161SW2266 | 21170 | 181SW22 | 21372 |
| 24" | 161SW24 | 21171 | 161SW2466 | 21172 | 181SW24 | 21373 |
| 26" | 161SW26 | 22179 | 161SW2666 | 21174 | 181SW26 | 21375 |
| 28" | 161SW28 | 21175 | 161SW2866 | 21176 | 181SW28 | 21378 |
| 30" | 161SW30 | 21178 | 161SW3066 | 21179 | 181SW30 | 21379 |
| 32" | 161SW32 | 22180 | 161SW3266 | 21181 | 181SW32 | 21380 |
| 34" | 161SW34 | 21182 | 161SW3466 | 21183 | 181SW34 | 21381 |
| 36" | 161SW36 | 21185 | 161SW3666 | 21186 | 181SW36 | 21382 |
| 38" | 161SW38 | 22182 | 161SW3866 | 21188 | 181SW38 | 21384 |
| 40" | 161SW40 | 22181 | 161SW4066 | 22190 | 181SW40 | 21385 |
| 42" | 161SW42 | 21192 | 161SW4266 | 21193 | 181SW42 | 21386 |
| 44" | 161SW44 | 22183 | 161SW4466 | 21195 | 181SW44 | 21207 |
| 46" | 161SW46 | 22184 | 161SW4666 | 21196 | 181SW46 | 21212 |
| 48" | 161SW48 | 21197 | 161SW4866 | 21198 | 181SW48 | 21387 |
| 50" | 161SW50 | 23068 | 161SW5066 | 21602 | 181SW50 | 21388 |
| 52" | 161SW52 | 21936 | 161SW5266 | 21200 | 181SW52 | 21462 |
| 54" | 161SW54 | 23069 | 161SW5466 | 21201 | 181SW54 | 21389 |
| 56" | 161SW56 | 23070 | 161SW5666 | 21603 | 181SW56 | 21390 |
| 58" | 161SW58 | 23071 | 161SW5866 | 23072 | 181SW58 | 22253 |
| 60" | 161SW60 | 21203 | 161SW6066 | 21204 | 181SW60 | 21391 |
| 72" | 161SW72 | 21208 | 161SW7266 | 21209 | 181SW72 | 21394 |
| 84" | 161SW84 | 22898 | 161SW8466 | 21211 | 181SW84 | 21395 |

For Lengths not listed in chart, or assemblies with sealant applied, consult price list. Contact Tectran for other end configurations.



HOSE ASSEMBLIES & BULK HOSE ALSO AVAILABLE
IN ARTICFLEX HOSE RATED TO -65°F
See page 76 & 82 or visit WWW.TECTRAN.COM



AIR BRAKE HOSE ASSEMBLIES

ARTICFLEX HOSE ASSEMBLIES



- **ArticFlex** - the name is assurance of a flexible, long-lasting, cold temperature performance, hose assembly
- Made using special SAE J1402 hose rated for -65°F
- Meets or exceeds SAE J1402 - Type A - DOT FMVSS No. 106 - Brake Hoses, 49 CFR 571.106



| Length | SINGLE SWIVEL END | | | | | | DUAL SWIVEL ENDS | | | |
|--------|------------------------|-----------|------------------------|-----------|------------------------|-----------|-----------------------|-----------|-----------------------|-----------|
| | 3/8" HOSE I.D. | | | | 1/2" HOSE | | 3/8" HOSE I.D. | | 1/2" HOSE | |
| | 1/4" Fixed x 1/4" Swvl | | 3/8" Fixed x 3/8" Swvl | | 3/8" Fixed x 3/8" Swvl | | Dual 3/8" Swivel Ends | | Dual 3/8" Swivel Ends | |
| | Part No. | Stk. Code | Part No. | Stk. Code | Part No. | Stk. Code | Part No. | Stk. Code | Part No. | Stk. Code |
| 16" | 16A16 | 23088 | 16A16-66 | 23101 | 18A16 | 23108 | 16ASW1666 | 23117 | 18ASW16 | 23129 |
| 18" | 16A18 | 23089 | 16A18-66 | 21214 | 18A18 | 21396 | 16ASW1866 | 21706 | 18ASW18 | 23130 |
| 20" | 16A20 | 21559 | 16A20-66 | 21215 | 18A20 | 21397 | 16ASW2066 | 21464 | 18ASW20 | 21469 |
| 22" | 16A22 | 23090 | 16A22-66 | 23102 | 18A22 | 21938 | 16ASW2266 | 23118 | 18ASW22 | 23131 |
| 24" | 16A24 | 21216 | 16A24-66 | 21217 | 18A24 | 21398 | 16ASW2466 | 21465 | 18ASW24 | 21470 |
| 26" | 16A26 | 21218 | 16A26-66 | 21219 | 18A26 | 21399 | 16ASW2666 | 21707 | 18ASW26 | 23132 |
| 28" | 16A28 | 21220 | 16A28-66 | 21221 | 18A28 | 21400 | 16ASW2866 | 21487 | 18ASW28 | 21471 |
| 30" | 16A30 | 21222 | 16A30-66 | 21223 | 18A30 | 21401 | 16ASW3066 | 21466 | 18ASW30 | 21472 |
| 32" | 16A32 | 21224 | 16A32-66 | 21225 | 18A32 | 21402 | 16ASW3266 | 21488 | 18ASW32 | 21490 |
| 34" | 16A34 | 23091 | 16A34-66 | 21246 | 18A34 | 23109 | 16ASW3466 | 21708 | 18ASW34 | 23133 |
| 36" | 16A36 | 21226 | 16A36-66 | 21227 | 18A36 | 21403 | 16ASW3666 | 21467 | 18ASW36 | 21473 |
| 38" | 16A38 | 23092 | 16A38-66 | 21228 | 18A38 | 23110 | 16ASW3866 | 23119 | 18ASW38 | 23134 |
| 40" | 16A40 | 23093 | 16A40-66 | 21229 | 18A40 | 21404 | 16ASW4066 | 21959 | 18ASW40 | 23135 |
| 42" | 16A42 | 21230 | 16A42-66 | 21231 | 18A42 | 21405 | 16ASW4266 | 21709 | 18ASW42 | 23136 |
| 44" | 16A44 | 23094 | 16A44-66 | 21232 | 18A44 | 21406 | 16ASW4466 | 23120 | 18ASW44 | 23137 |
| 46" | 16A46 | 23095 | 16A46-66 | 23103 | 18A46 | 23111 | 16ASW4666 | 23121 | 18ASW46 | 23138 |
| 48" | 16A48 | 21233 | 16A48-66 | 21234 | 18A48 | 21407 | 16ASW4866 | 21468 | 18ASW48 | 21474 |
| 50" | 16A50 | 23096 | 16A50-66 | 23104 | 18A50 | 23112 | 16ASW5066 | 23122 | 18ASW50 | 23139 |
| 52" | 16A52 | 21235 | 16A52-66 | 21236 | 18A52 | 21408 | 16ASW5266 | 23123 | 18ASW52 | 23140 |
| 54" | 16A54 | 23097 | 16A54-66 | 23105 | 18A54 | 23113 | 16ASW5466 | 23124 | 18ASW54 | 23141 |
| 56" | 16A56 | 23098 | 16A56-66 | 21237 | 18A56 | 21409 | 16ASW5666 | 23125 | 18ASW56 | 23142 |
| 58" | 16A58 | 23099 | 16A58-66 | 23106 | 18A58 | 23114 | 16ASW5866 | 23126 | 18ASW58 | 23143 |
| 60" | 16A60 | 21238 | 16A60-66 | 21239 | 18A60 | 21410 | 16ASW6066 | 21489 | 18ASW60 | 21491 |
| 72" | 16A72 | 21240 | 16A72-66 | 21241 | 18A72 | 23115 | 16ASW7266 | 23127 | 18ASW72 | 23144 |
| 84" | 16A84 | 23100 | 16A84-66 | 23107 | 18A84 | 23116 | 16ASW8466 | 23128 | 18ASW84 | 23145 |

For Lengths not listed in chart, or assemblies with sealant applied, consult price list. Contact Tectran for other end configurations.

AIR BRAKE HOSE ASSEMBLIES

45° FEMALE DUAL SWIVEL

- Direct replacement hoses for all late model PACCAR, Peterbilt and Kenworth
- 45° female swivel fittings on both ends
- Rugged hose construction resistant to UV, ozone, fuels, and other commonly used road chemicals
- Operating temperature: -40°F to 200°F
- Meets or exceeds SAE J1402 - Type A - DOT FMVSS No. 106 - Brake Hoses, 49 CFR 571.106



| Length | 3/8" HOSE I.D. | | 1/2" HOSE I.D. | |
|--------|-----------------------|-----------|-----------------------|-----------|
| | Dual 3/8" Swivel Ends | | Dual 3/8" Swivel Ends | |
| | Part No. | Stk. Code | Part No. | Stk. Code |
| 16" | 16145SW16 | 23146 | 18145SW16 | 23154 |
| 18" | 16145SW18 | 21678 | 18145SW18 | 21983 |
| 20" | 16145SW20 | 21679 | 18145SW20 | 21984 |
| 22" | 16145SW22 | 23147 | 18145SW22 | 21975 |
| 24" | 16145SW24 | 21680 | 18145SW24 | 21939 |
| 26" | 16145SW26 | 21681 | 18145SW26 | 21976 |
| 28" | 16145SW28 | 21682 | 18145SW28 | 21977 |
| 30" | 16145SW30 | 21683 | 18145SW30 | 21978 |
| 32" | 16145SW32 | 21684 | 18145SW32 | 21940 |
| 34" | 16145SW34 | 21685 | 18145SW34 | 21979 |
| 36" | 16145SW36 | 21686 | 18145SW36 | 21941 |
| 38" | 16145SW38 | 23148 | 18145SW38 | 23155 |
| 40" | 16145SW40 | 21687 | 18145SW40 | 22199 |
| 42" | 16145SW42 | 21971 | 18145SW42 | 21981 |
| 44" | 16145SW44 | 21688 | 18145SW44 | 22200 |
| 46" | 16145SW46 | 23149 | 18145SW46 | 23156 |
| 48" | 16145SW48 | 21689 | 18145SW48 | 21982 |
| 50" | 16145SW50 | 23150 | 18145SW50 | 23157 |
| 52" | 16145SW52 | 23151 | 18145SW52 | 23158 |
| 54" | 16145SW54 | 21690 | 18145SW54 | 23159 |
| 56" | 16145SW56 | 23152 | 18145SW56 | 23160 |
| 58" | 16145SW58 | 23153 | 18145SW58 | 23161 |
| 60" | 16145SW60 | 21691 | 18145SW60 | 22218 |
| 72" | 16145SW72 | 21694 | 18145SW72 | 22377 |
| 84" | 16145SW84 | 21696 | 18145SW84 | 22379 |

**SEE FITTING SECTION FOR SAE 45°
FLARE FITTINGS**
Starting on page 114





AIR SHIFT TRANSMISSION HOSE ASSEMBLIES

- Live swivel end ensures easy installation & allows for movement without binding
- Wide selection of lengths & custom sizes available
- Steel retaining ring securely locks barbed insert into fitting housing
- Barbed hose inserts on both ends when crimped provide added durability
- Rugged hose construction resistant to UV, ozone, fuels, and other commonly used road chemicals
- Operating temperature: -40° F to 200° F

Cross section of Live Swivel fitting

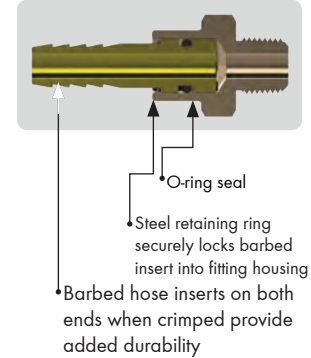

| Length | 1/4" HOSE I.D. | |
|--------|-------------------------------|-----------|
| | 1/8" Fixed X 1/8" Live Swivel | |
| | Part No. | Stk. Code |
| 12" | 14T12 | 22234 |
| 15" | 14T15 | 22235 |
| 16" | 14T16 | 22236 |
| 17" | 14T17 | 22237 |
| 18" | 14T18 | 22238 |
| 20" | 14T20 | 22239 |
| 24" | 14T24 | 22240 |
| 26" | 14T26 | 22241 |
| 27" | 14T27 | 22242 |
| 28" | 14T28 | 22243 |
| 29" | 14T29 | 22244 |
| 30" | 14T30 | 22245 |
| 32" | 14T32 | 22246 |
| 34" | 14T34 | 22247 |
| 36" | 14T36 | 22248 |

NOSE BOX HOSE ASSEMBLIES

- 3/8" hose I.D.
- 6" long

Part No. 16G06-88

Stk. Code 21917

1/2" NPT ends



Part No. 16G06-88F

Stk. Code 21918

1/2" NPT end to 1/2"-14 Female end

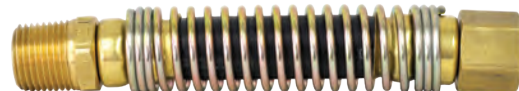

SLIDER HOSE ASSEMBLIES

- 3/8" hose I.D. with factory crimped swivel hose fittings & adapters
- Detachable frame fittings with 7/8"-20 mounting threads
- Integral NT air brake fittings for nylon tubing
- Rugged hose construction resistant to UV, ozone, fuels, and other commonly used road chemicals
- Operating temperature: -40°F to 200°F
- Meets or exceeds SAE J1402 - Type A - DOT FMVSS No. 106 - Brake Hoses, 49 CFR 571.106



| Length | Dual 3/8" O.D Tube Fittings | | Dual 1/2" O.D Tube Fittings | |
|--------|-----------------------------|-----------|-----------------------------|-----------|
| | Part No. | Stk. Code | Part No. | Stk. Code |
| 72" | 16SL7262 | 21249 | 16SL7282 | 21250 |
| 78" | 16SL7862 | 21477 | - | - |
| 88" | - | - | 16SL8882 | 21251 |
| 96" | 16SL9662 | 21252 | 16SL9682 | 21253 |
| 102" | 16SL10262 | 21478 | 16SL10282 | 21479 |
| 108" | 16SL10862 | 21243 | 16SL10882 | 21244 |
| 112" | 16SL11262 | 21530 | 16SL11282 | 21532 |
| 120" | 16SL12062 | 21245 | 16SL12082 | 21247 |
| 138" | 16SL13862 | 21527 | 16SL13882 | 21528 |



ADDITIONAL RESOURCES

Additional information about TECTRAN's Product Line can be found in the Resource Center Library on WWW.TECTRAN.COM



AIR COMPRESSOR DISCHARGE HOSE ASSEMBLIES

- Teflon inner tube
- Durable stainless steel outer braid
- Maximum working pressure of 1000 psi
- Hose Diameters: 1/2"
- Operating temperatures from -65°F to 450°F



DUAL 5/8" 45° FEMALE SWIVEL

| Part No. | Stk. Code | Length |
|----------|-----------|--------|
| 19DSW318 | 21430 | 18" |
| 19DSW324 | 21431 | 24" |
| 19DSW330 | 21432 | 30" |
| 19DSW336 | 21433 | 36" |
| 19DSW342 | 21933 | 42" |
| 19DSW348 | 21434 | 48" |
| 19DSW352 | 21435 | 52" |
| 19DSW354 | 21436 | 54" |
| 19DSW360 | 21521 | 60" |
| 19DSW372 | 21437 | 72" |
| 19DSW384 | 21438 | 84" |
| 19DSW396 | 21439 | 96" |



5/8" STRAIGHT TUBE & 5/8" COMPRESSION AIR BRAKE BODY

| Part No. | Stk. Code | Length |
|----------|-----------|--------|
| 19DY018 | 21447 | 18" |
| 19DY024 | 21448 | 24" |
| 19DY030 | 21449 | 30" |
| 19DY036 | 21450 | 36" |



DUAL 5/8" STRAIGHT TUBE

| Part No. | Stk. Code | Length |
|----------|-----------|--------|
| 19DT024 | 21441 | 24" |
| 19DT038 | 22450 | 38" |
| 19DT036 | 21442 | 36" |



DUAL 5/8" COMPRESSION AIR BRAKE BODY

| Part No. | Stk. Code | Length |
|----------|-----------|--------|
| 19DC318 | 21428 | 18" |
| 19DC324 | 21429 | 24" |

BULK DISCHARGE HOSE

- Bulk Hose can be assembled with fittings to desired lengths
- Extruded smooth inner PTFE core tube prevents carbon accumulation
- Stainless steel braided outer reinforcement
- Operating temperature range of -65° F to 450° F



| Part No. | Stk. Code | Nominal I.D. | Nominal O.D. | Working Press. | Min. Burst Pres.(psi) | Min. Bend Radius | Length |
|-----------|-----------|--------------|--------------|----------------|-----------------------|------------------|-------------|
| HR14-10-Q | 21493 | 1/2" | 5/8" | 1750 | 7000 | 6 1/2" | 25 ft Coil |
| HR14-10-1 | 21494 | 1/2" | 5/8" | 1750 | 7000 | 6 1/2" | 100 ft Coil |
| HR14-12-Q | 21495 | 5/8" | 3/4" | 1500 | 6000 | 7 1/2" | 25 ft Coil |
| HR14-12-1 | 21496 | 5/8" | 3/4" | 1500 | 6000 | 7 1/2" | 100 ft Coil |

REUSABLE FITTINGS FOR DISCHARGE HOSE



STRAIGHT TUBE

| Part No. | Stk. Code | Hose O.D. |
|-----------|-----------|-----------|
| 19DS-1010 | 21497 | 5/8" |
| 19DS-1212 | 21498 | 3/4" |



FEMALE SWIVEL

| Part No. | Stk. Code | Hose O.D. | Pipe Thrd |
|-----------|-----------|-----------|------------|
| 19DF-1010 | 21500 | 5/8" | 7/8"-14 |
| 19DF-1212 | 21501 | 3/4" | 1 1/16"-12 |



STEEL NUT

| Part No. | Stk. Code | Hose O.D. |
|----------|-----------|-----------|
| 19CN-10 | 21506 | 5/8" |
| 19CN-12 | 21507 | 3/4" |



COMPRESSION

| Part No. | Stk. Code | Hose O.D. | Pipe Thrd |
|-----------|-----------|-----------|-----------|
| 19DC-1010 | 21502 | 5/8" | 13/16"-18 |
| 19DC-1212 | 21503 | 3/4" | 1"-18 |



BRASS SLEEVE

| Part No. | Stk. Code | Hose O.D. |
|----------|-----------|-----------|
| 19DCS-10 | 21504 | 5/8" |
| 19DCS-12 | 21505 | 3/4" |



MALE PIPE

| Part No. | Stk. Code | Hose O.D. | Pipe Thrd |
|-----------|-----------|-----------|-----------|
| 19DM-0810 | 21499 | 5/8" | 1/2"-14 |

CAB HOSES

SHOP COILS

- 1/4" coiled air hose for air tool or other low pressure pneumatic applications
- Self-storing, adjustable length
- 2 x 1/4" NPT male swivel fittings with spring guards are included
- 200 psi is maximum recommended operating pressure at 78 °F
- Dual kit is OSHA compliant (STD 1-13-001) when used with (included) safety tip only

| Part No. | Stk. Code | Description | Extended Length | Coil Only Part No. |
|----------|-----------|-----------------|-----------------|--------------------|
| 14504 | 23013 | Single tool kit | 25 ft | SC254 |
| 14506 | 23015 | Single tool kit | 50 ft | SC504 |
| 14505 | 23014 | Dual tool kit | 25 ft | SC254 |
| 14507 | 23016 | Dual tool kit | 50 ft | SC504 |



SINGLE TOOL KIT

- Includes coil assembly along with parts shown below:



DUAL TOOL KIT

- Includes coil assembly along with parts shown below:

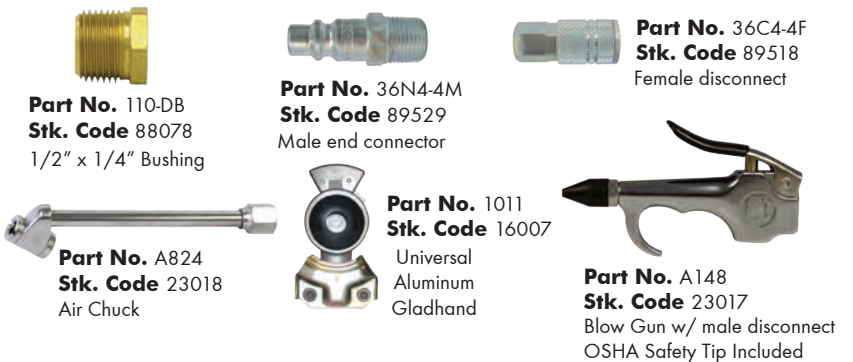

CAB BLOWER KIT

- Mounts under seat
- 1/4" tee fitting
- 72" coil with spring guards
- Coil 1/4" diameter tube
- Air Blow Gun A148
- OSHA compliant (STD 1-13-001) when used with (included) safety tip only

| Part No. | Stk. Code | Description |
|----------|-----------|--|
| 14501 | 23012 | Cab blower kit - includes OSHA tip loose in bag |
| 14501-1 | 23030 | Cab blower kit - w/OSHA tip installed in A148 blow gun |



Part No. A148OSHA
Stk. Code 23033



VALVE EXTENSION

Part No. AV-06
Stk. Code 23029

- 6" tire inflation valve extension with clamp
- Allows for easy access to check air pressure
- Easy installation





TIRE INFLATION SYSTEM REPLACEMENT HOSES

DIAMONDGUARD HOSES

The unique **DIAMONDGUARD** hoses consist of:

- ← Large diameter bent tube design for outer hoses
- ← Permanent crimped on shell design
- ← Rugged stainless steel braided armor
Flexible, chemical-resistant EPDM core
 - Extreme cut-through & abrasion resistance
 - Superior kink resistance
 - Excellent low temperature properties
- ← Knurled fitting nuts for easy hand-tight installation
- ← Superior check valve design
 - Unsurpassed durability
 - Improved air flow

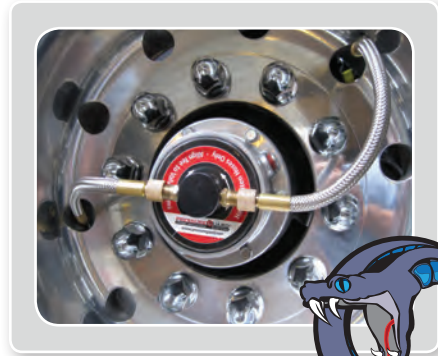

Part No. P37000
Stk. Code 76031



Part No. P37002
Stk. Code 76035



Part No. P37001
Stk. Code 76033



Part No. P37004
Stk. Code 76267



| Part No. | Stk. Code | Description | Rim Diameter | Interchange |
|----------|-----------|----------------------------------|---|----------------------------------|
| P37000 | 76031 | Inner for Dual Wheels | 19.5" or Larger | 31373-00 |
| P37001 | 76033 | Outer for Dual Wheels | 19.5" or Larger | 31363-00 |
| P37002 | 76035 | Super Single Wheels & Dual Inner | Single 22.5" or 24.5", Dual Inner 17.5" or Smaller | 31374-00 |
| P37003 | 76266 | Inner for Dual Wheels | 17.5" or Smaller | n/a |
| P37004 | 76267 | Outer for Dual Wheels | 17.5" or Smaller | 31364-00 |
| P38000 | 76036 | Inner for Dual Wheels | 19.5" or Larger | PressureGuard direct replacement |
| P38001 | 76037 | Outer for Dual Wheels | 19.5" or Larger | PressureGuard direct replacement |
| P38002 | 76038 | Super Single Wheels | 22.5" or 24.5" | PressureGuard direct replacement |
| P38003 | 76039 | Inner for Dual Wheels | 17.5" or Smaller | PressureGuard direct replacement |
| P38004 | 76040 | Outer for Dual Wheels | 17.5" or Smaller | PressureGuard direct replacement |
| P39000 | 76342 | Inner for Dual Wheels | Any Size | VS-29003-1 (EC/CP System) |
| P39001 | 76343 | Outer for Dual Wheels | 22.5" or Larger | VS-29004-2 (EC/CP System) |
| P39002 | 76344 | Super Single Wheels | 22.5" or 24.5" | VS-29003-1 (EC/CP System) |
| P39004 | 76345 | Outer for Dual Wheels | 19.5" or Smaller | VS-29004-1 (EC/CP System) |

BRAKE LINES

HYDRAULIC BRAKE LINES

- *"SA" suffix - Used for armored brake lines (which have spiral wire winding to protect line from damage by flying materials and allows tubing to be bent without kinking)



| Length | 3/16" Tubing O.D | | 1/4" Tubing O.D | | 5/16" Tubing O.D | | 3/8" Tubing O.D | |
|--------|------------------|-----------|-----------------|-----------|------------------|-----------|-----------------|-----------|
| | Part No. | Stk. Code | Part No. | Stk. Code | Part No. | Stk. Code | Part No. | Stk. Code |
| 8" | BL308 | 24001 | BL408 | 24011 | BL508 | 24019 | - | - |
| 12" | BL312 | 24002 | BL412 | 24012 | BL512 | 24020 | B612 | 24031 |
| 12" | BL312SA* | 24003 | - | - | - | - | - | - |
| 20" | BL320 | 24004 | BL420 | 24013 | BL520 | 24022 | BL620 | 24032 |
| 30" | BL330 | 24005 | BL430 | 24014 | BL530 | 24024 | BL630 | 24033 |
| 20" | BL320SA | 24077 | - | - | - | - | - | - |
| 30" | BL330SA* | 24078 | - | - | - | - | - | - |
| 40" | BL340 | 24006 | BL440 | 24015 | BL540 | 24026 | BL640 | 24035 |
| 40" | BL340SA* | 24079 | - | - | - | - | - | - |
| 51" | BL351 | 24007 | BL451 | 24016 | BL551 | 24028 | BL651 | 24036 |
| 51" | BL351SA* | 24080 | - | - | - | - | - | - |
| 60" | BL360 | 24008 | BL460 | 24017 | BL560 | 24030 | BL660 | 24037 |
| 60" | BL360SA* | 24081 | - | - | - | - | - | - |
| 72" | BL372 | 24009 | BL472 | 24018 | - | - | - | - |
| 72" | BL372SA* | 24010 | - | - | - | - | - | - |

SEE FITTING SECTION FOR GREASE FITTING SELECTION
Starting on page 123

STEEL BRAKE LINE TUBING



| Part No. | Stk. Code | O.D. | Length |
|----------|-----------|-------|--------|
| BLT3X25 | 24038 | 3/16" | 25 ft |
| BLT4X25 | 24039 | 1/4" | 25 ft |
| BLT5X25 | 24040 | 5/16" | 25 ft |
| BLT6X25 | 24041 | 3/8" | 25 ft |

CROSSOVER TUBE

Part No. BLXX412
Stk. Code 24042

- Crossover tube for hydraulic brakes
- (2) 1/4" inverted flare nuts





HOSE & TUBING

POLYETHYLENE TUBING

- Applications: air, water, most acids, and alkalis
- Low density
- Tubing is used to vapor proof wiring on trucks and trailers
- Accepts standard brass fittings of the type used on copper tubing, without requiring the use of an insert to support the wall
- Barb type nylon fittings may also be used
- Temperature Range: -40°F to 160°F
- Rated at maximum 75 psi working pressure
- Available in natural color (semi-transparent white) and in sunlight resistant black



| Part No. | Stk. Code | Inside Dia. | Outside Dia. | Color | Length |
|----------|-----------|-------------|--------------|---------|--------|
| 844 | 27110 | 11/64 | 1/4" | Natural | 500 ft |
| 845B | 21934 | 3/16" | 5/16" | Black | 100 ft |
| 846 | 27112 | 1/4" | 3/8" | Natural | 500 ft |
| 846B | 27113 | 1/4" | 3/8" | Black | 500 ft |
| 848 | 27115 | 3/8" | 1/2" | Natural | 500 ft |
| 848B | 27116 | 3/8" | 1/2" | Black | 500 ft |
| 850 | 27119 | 1/2" | 5/8" | Natural | 500 ft |
| 850B | 27121 | 1/2" | 5/8" | Black | 500 ft |
| 852 | 27123 | 5/8" | 3/4" | Natural | 100 ft |

FUEL LINE HOSE

- Braided - reinforced
- Automotive and farm equipment fuel lines
- Temperature Range: -25°F to 180°F
- Working pressure 50 psi



| Part No. | Stk. Code | Inside Dia. | Outside Dia. | Length |
|----------|-----------|-------------|--------------|--------|
| FLH-4 | 27140 | 1/4" | 1/2" | 250 ft |
| FLH-4-Q | 27172 | 1/4" | 1/2" | 25 ft |
| FLH-5 | 27141 | 5/16" | 9/16" | 250 ft |
| FLH-5-Q | 27173 | 5/16" | 9/16" | 25 ft |
| FLH-6 | 27142 | 3/8" | 5/8" | 250 ft |
| FLH-6-Q | 27174 | 3/8" | 5/8" | 25 ft |

WIRE HOSE CLAMP

- Zinc-plated carbon steel spring wire
- For use with fuel line hose only



| Part No. | Stk. Code | Hose I.D. |
|-----------|-----------|-------------|
| 41538-WHD | 90248 | 3/16", 1/4" |
| 41539-WHD | 90249 | 5/16" |
| 41540-WHD | 90250 | 3/8" |

HOSE & TUBING

GENERAL PURPOSE HOSE

- For push on fittings
- Hydraulic oil, mineral oil, antifreeze
- Temperature Range: -40°F to 200°F
- Working pressure 250 psi



| Part No. | Stk. Code | Inside Dia. | Outside Dia. | Length |
|----------|-----------|-------------|--------------|--------|
| 761-4 | 27166 | 1/4" | 1/2" | 250 ft |
| 761-4-T | 27167 | 1/4" | 1/2" | 50 ft |
| 761-6 | 27168 | 3/8" | 5/8" | 250 ft |
| 761-6-T | 27169 | 3/8" | 5/8" | 50 ft |
| 761-8 | 27170 | 1/2" | 3/4" | 250 ft |
| 761-8-T | 27171 | 1/2" | 3/4" | 50 ft |
| 761-10 | 27164 | 5/8" | 29/32" | 250 ft |
| 761-10-T | 27165 | 5/8" | 29/32" | 50 ft |

CLEAR VINYL TUBING

- Water or anti-freeze only. No fuel
- Temperature Range: -20°F to 160°F



| Part No. | Stk. Code | Inside Dia. | Outside Dia. | Working Press | Length |
|----------|-----------|-------------|--------------|---------------|--------|
| JFT-42 | 27145 | 1/8" | 1/4" | 65 psi | 100 ft |
| JFT-64 | 27147 | 1/4" | 3/8" | 55 psi | 100 ft |
| JFT-86 | 27148 | 3/8" | 1/2" | 45 psi | 100 ft |
| JFT-108 | 27143 | 1/2" | 5/8" | 30 psi | 100 ft |

HEATER HOSE

- Recommended for temperatures -40°F to 275°F
- Elastomer polyester reinforced
- Meets performance requirements of SAE J20 R3 Class D2, SAE J2387
- Made in the USA

STANDARD OEM HOSE - BLACK



| Part No. | Stk. Code | Inside Dia. | Length |
|-----------|-----------|-------------|--------|
| H11-062 | 27184 | .625" | 50 ft |
| H11-075 | 27185 | .750" | 50 ft |
| H11-075-2 | 27429 | .750" | 250 ft |

PREMIUM HOSE - RED



| Part No. | Stk. Code | Inside Dia. | Length |
|----------|-----------|-------------|--------|
| H14-050 | 27186 | .500" | 50 ft |
| H14-062 | 27187 | .625" | 50 ft |
| H14-075 | 27188 | .750" | 50 ft |
| H14-100 | 27189 | 1" | 50 ft |



SILICONE HOSE

SILICONE HEATER HOSE

- Silicone polyester reinforced wall
- Recommended for temperatures -65°F to 350°F
- High burst strength and excellent heat resistance
- Resistant to coolants, cold leaks, cracking, peeling, aging, and ozone
- Meets performance requirements of SAE J20 R3 Class 4.1.4
- Made in the USA



| | | | MATCHING CLAMP | | |
|----------|-----------|------------------|----------------|-----------|------------------|
| Part No. | Stk. Code | ID x Length | Part No. | Stk. Code | Description |
| H21-038 | 27190 | .375 ID x 50 ft | SHC8 | 46138 | 1/2" - 29/32" |
| H21-050 | 27191 | .500 ID x 50 ft | SHC8 | 46138 | 1/2" - 29/32" |
| H21-062 | 27192 | .625 ID x 50 ft | SHC10 | 46127 | 5/8" - 1 1/16" |
| H21-075 | 27193 | .750 ID x 50 ft | SHC10 | 46127 | 5/8" - 1 1/16" |
| H21-100 | 27194 | 1.000 ID x 50 ft | SHC12 | 46128 | 1 1/16" - 1 1/4" |

SILICONE COOLANT (RAD) HOSE

- Silicone polyester reinforced wall
- Recommended for temperatures -65°F to 350°F
- Meets performance requirements of SAE J20R1 & TMC RP 303B Class 1 and Class 2
- Resistant to oil splash and petrochemical exposure
- Made in the USA



| | | | | MATCHING CLAMP | | |
|----------|-----------|-----------------|---------------|----------------|-----------|------------------|
| Part No. | Stk. Code | ID x Length | Max Burst psi | Part No. | Stk. Code | Description |
| H42-075 | 27195 | .750 ID x 3 ft | 459 | HK12 | 46176 | 1 1/16" - 1 1/4" |
| H42-100 | 27196 | 1.000 ID x 3 ft | 412 | HK20 | 46178 | 13/16" - 1 3/4" |
| H42-125 | 27197 | 1.250 ID x 3 ft | 355 | HK20 | 46178 | 13/16" - 1 3/4" |
| H42-138 | 27198 | 1.375 ID x 3 ft | 328 | HK24 | 46179 | 1 1/16" - 2" |
| H42-150 | 27199 | 1.500 ID x 3 ft | 313 | HK200 | 46180 | 1 1/4" - 2 1/8" |
| H42-162 | 27241 | 1.625 ID x 3 ft | 248 | HK200 | 46180 | 1 1/4" - 2 1/8" |
| H42-175 | 27200 | 1.750 ID x 3 ft | 293 | HK200 | 46180 | 1 1/4" - 2 1/8" |
| H42-187 | 27201 | 1.875 ID x 3 ft | 280 | HK200 | 46180 | 1 1/4" - 2 1/8" |
| H42-200 | 27202 | 2.000 ID x 3 ft | 271 | HK250 | 46181 | 1 3/4" - 2 5/8" |
| H42-212 | 27203 | 2.125 ID x 3 ft | 266 | HK250 | 46181 | 1 3/4" - 2 5/8" |
| H42-225 | 27204 | 2.250 ID x 3 ft | 256 | HK250 | 46181 | 1 3/4" - 2 5/8" |
| H42-250 | 27205 | 2.500 ID x 3 ft | 244 | HK300 | 46182 | 2 1/4" - 3 1/8" |
| H42-275 | 27206 | 2.750 ID x 3 ft | 233 | HK350 | 46183 | 2 3/4" - 3 5/8" |
| H42-300 | 27207 | 3.000 ID x 3 ft | 180 | HK350 | 46183 | 2 3/4" - 3 5/8" |

SILICONE TURBOCHARGER HOSE

- Silicone fiberglass reinforced wall
- Recommended for temperatures -65°F to 550°F
- Rigid non-kinking
- Resistant to oil splash and petrochemical exposure
- Made in the USA

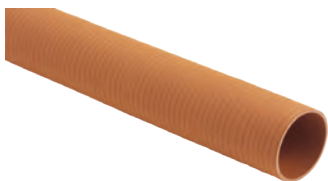

| | | | MATCHING CLAMP | | |
|----------|-----------|----------------|----------------|-----------|------------------|
| Part No. | Stk. Code | ID x Length | Part No. | Stk. Code | Description |
| H46-200 | 27208 | 2.00 ID x 3 ft | HTS206 | 46403 | 2.06" - 2.37" |
| H46-250 | 27209 | 2.50 ID x 3 ft | HTS225 | 46187 | 2 1/4" - 2 9/16" |
| H46-300 | 27210 | 3.00 ID x 3 ft | HTS306 | 46189 | 3 1/16" - 3 3/8" |
| H46-350 | 27211 | 3.50 ID x 3 ft | HTS344 | 46190 | 3 7/16" - 3 3/4" |
| H46-400 | 27212 | 4.00 ID x 3 ft | HTS388 | 46192 | 3 7/8" - 4 3/16" |

CONNECTOR HOSES - SILICONE

**All Connector Hose lengths can be cut shorter to fit requirements*

HUMP HOSE

- Compensates for misalignment and offset
- Vibration isolation
- Aramid reinforced
- Recommended for temperatures -65° to 500°F
- Resistant to oil splash and petrochemical exposure
- Hot or cold side compatible
- Made in the USA



MATCHING CLAMPS

| Part No. | Stk. Code | ID x Length | Part No. | Stk. Code | Description |
|----------|-----------|-------------|----------|-----------|-------------|
| H51-500 | 27214 | 5.00" x 6" | HP4 | 46205 | 4 1/4" - 6" |
| H51-600 | 27215 | 6.00" x 6" | HP5 | 46206 | 6 1/4" - 9" |

CAC HOSE - CHARGE AIR COOLER

- Compensates for misalignment and offset
- Aramid reinforced 4 ply silicone
- Convolutions increase flexibility in high vibration situations
- Type 316 stainless steel restraining rings reduce swell and increase hoop strength
- Recommended for temperatures -65° to 500°F
- Hot or cold side compatible
- Made in the USA



MATCHING CLAMPS

| Part No. | Stk. Code | ID x Length | Part No. | Stk. Code | Description |
|----------|-----------|--------------------|----------|-----------|------------------|
| H71-250 | 27216 | 2.50" x 6" | HTS225 | 46187 | 2 1/4" - 2 9/16" |
| H71-300 | 27217 | 3.00" x 6" | HTS306 | 46189 | 3 1/16" - 3 3/8" |
| H71-350 | 27218 | 3.50" x 6" | HTS344 | 46190 | 3 7/16" - 3 3/4" |
| H71-351 | 27219 | 3.50" / 4.00" x 6" | HTS306 | 46189 | 3 1/16" - 3 3/8" |
| | | | HTS344 | 46190 | 3 7/16" - 3 3/4" |
| H71-400 | 27220 | 4.00" x 6" | HTS406 | 46193 | 4 1/16" - 4 3/8" |
| H71-407 | 27221 | 4.00" x 7.5" | HTS406 | 46193 | 4 1/16" - 4 3/8" |
| H71-408 | 27222 | 4.00" x 8" | HTS406 | 46193 | 4 1/16" - 4 3/8" |
| H71-458 | 27223 | 4.50" x 8" | HTS456 | 46195 | 4 9/16" - 4 7/8" |

ELBOW CONNECTORS

- 4-Ply silicone polyester reinforced
- Silicone liner creates barrier to isolate medium
- Recommended for temperatures -65°F to 350°F
- Meets performance requirements of SAE J20R1 & TMC RP 303B Class 1 and Class 2
- Hot or cold side compatible
- Leg length is measure from the center line of the elbow or 45°/90°
- Made in the USA



MATCHING CLAMPS

| Part No. | Stk. Code | Elbow | ID x Length | Part No. | Stk. Code | Description |
|----------|-----------|-----------|--------------------|----------|-----------|-----------------|
| H86-250 | 27224 | 45° Elbow | 2.50" legs 6" x 6" | HK300 | 46182 | 2 1/4" - 3 1/8" |
| H86-275 | 27225 | 45° Elbow | 2.75" legs 6" x 6" | HK350 | 46183 | 2 3/4" - 3 5/8" |
| H86-300 | 27226 | 45° Elbow | 3.00" legs 6" x 6" | HK350 | 46183 | 2 3/4" - 3 5/8" |
| H86-350 | 27227 | 45° Elbow | 3.50" legs 6" x 6" | HK400 | 46184 | 3 1/4" - 4 1/8" |
| H86-400 | 27228 | 45° Elbow | 4.00" legs 6" x 6" | HK400 | 46184 | 3 1/4" - 4 1/8" |
| H96-200 | 27229 | 90° Elbow | 2.00" legs 6" x 6" | HK200 | 46180 | 1 1/4" - 2 1/8" |
| H96-225 | 27230 | 90° Elbow | 2.25" legs 6" x 6" | HK250 | 46181 | 1 3/4" - 2 5/8" |
| H96-250 | 27231 | 90° Elbow | 2.50" legs 6" x 6" | HK300 | 46182 | 2 1/4" - 3 1/8" |
| H96-275 | 27232 | 90° Elbow | 2.75" legs 6" x 6" | HK350 | 46183 | 2 3/4" - 3 5/8" |
| H96-300 | 27233 | 90° Elbow | 3.00" legs 6" x 6" | HK350 | 46183 | 2 3/4" - 3 5/8" |
| H96-350 | 27234 | 90° Elbow | 3.50" legs 6" x 6" | HK400 | 46184 | 3 1/4" - 4 1/8" |
| H96-400 | 27235 | 90° Elbow | 4.00" legs 6" x 6" | HK400 | 46184 | 3 1/4" - 4 1/8" |



HOSE CLAMPS

WORM GEAR

- Hose clamps are constructed of a stainless steel band and screw housing
- Zinc-plated carbon steel screw
- HP Series features a stainless steel screw

- 1/4" slotted head hex screw
- Band width 5/16"
- Torque: 15 in-lb



| Part No. | Stk. Code | Clamp Range |
|----------|-----------|----------------|
| MHC4 | 46100 | 1/4" - 5/8" |
| MHC6 | 46101 | 5/16" - 29/32" |
| MHC8 | 46102 | 1/2" - 1 1/16" |

- 5/16" slotted head hex screw
- Band width 9/16"
- Torque: 45 in-lb



| Part No. | Stk. Code | Clamp Range |
|----------|-----------|-------------------|
| SHC8 | 46138 | 1/2" - 29/32" |
| SHC10 | 46127 | 5/8" - 1 1/16" |
| SHC12 | 46128 | 11/16" - 1 1/4" |
| SHC16 | 46129 | 13/16" - 1 1/2" |
| SHC20 | 46130 | 13/16" - 1 3/4" |
| SHC24 | 46131 | 1 1/16" - 2" |
| SHC28 | 46132 | 1 5/16" - 2 1/4" |
| SHC32 | 46133 | 1 9/16" - 2 1/2" |
| SHC36 | 46134 | 1 13/16" - 2 3/4" |
| SHC40 | 46135 | 2 1/16" - 3" |
| SHC44 | 46136 | 2 5/16" - 3 1/4" |
| SHC48 | 46137 | 2 9/16" - 3 1/2" |

- Hi-Torque
- 5/16" 410 stainless steel slotted head hex screw
- Band width 5/8"
- Torque: 90 in-lb



| Part No. | Stk. Code | Clamp Range |
|----------|-----------|-----------------|
| HP2 | 46203 | 1 1/4" - 2 1/2" |
| HP3 | 46204 | 2 1/2" - 3 1/2" |
| HP4 | 46205 | 4 1/4" - 6" |
| HP5 | 46206 | 6 1/4" - 9" |

- 5/16" slotted head hex screw
- Band width 9/16"
- Torque: 45 in-lb



| Part No. | Stk. Code | Clamp Range |
|----------|-----------|------------------|
| HC6 | 46093 | 7/16" - 25/32" |
| HC8 | 46096 | 7/16" - 29/32" |
| HC10 | 46079 | 9/16" - 1 1/16" |
| HC12 | 46081 | 11/16" - 1 1/4" |
| HC16 | 46082 | 3/4" - 1 1/2" |
| HC20 | 46083 | 13/16" - 1 3/4" |
| HC24 | 46084 | 1 1/16" - 2" |
| HC28 | 46085 | 1 5/16" - 2 1/4" |
| HC32 | 46086 | 1 9/16" - 2 1/2" |
| HC36 | 46087 | 1 1/2" - 2 3/4" |
| HC40 | 46088 | 1 3/4" - 3" |
| HC44 | 46089 | 2" - 3 1/4" |
| HC48 | 46090 | 2 1/4" - 3 1/2" |
| HC52 | 46091 | 2 1/2" - 3 3/4" |
| HC56 | 46092 | 2 3/4" - 4" |
| HC64 | 46094 | 3 1/4" - 4 1/2" |
| HC72 | 46095 | 3 3/4" - 5" |
| HC80 | 46097 | 4 9/16" - 5 1/2" |
| HC88 | 46098 | 4 3/4" - 6" |
| HC96 | 46099 | 5 1/4" - 6 1/2" |
| HC104 | 46080 | 6" - 7" |

CONSTANT TORQUE

- 5/16" 410 stainless steel slotted head hex screw
- Band width 9/16"
- Torque: 45 in-lb



| Part No. | Stk. Code | Clamp Range |
|----------|-----------|-----------------|
| HK10 | 46175 | 9/16" - 1 1/16" |
| HK12 | 46176 | 11/16" - 1 1/4" |
| HK16 | 46177 | 13/16" - 1 1/2" |
| HK20 | 46178 | 13/16" - 1 3/4" |
| HK24 | 46179 | 1 1/16" - 2" |

HOSE CLAMPS

CONSTANT TORQUE T-BOLT

- Stainless steel
- Band width 3/4"
- Torque: 60 in-lb



| Part No. | Stk. Code | Clamp Range |
|----------|-----------|-----------------|
| HT250 | 46162 | 2 1/2" - 2 7/8" |
| HT275 | 46163 | 2 3/4" - 3" |
| HT288 | 46164 | 3" - 3 3/8" |
| HT325 | 46165 | 3 1/4" - 3 1/2" |
| HT344 | 46166 | 3 3/8" - 3 3/4" |
| HT375 | 46167 | 3 3/4" - 4" |
| HT425 | 46168 | 4 1/4" - 4 1/2" |
| HT475 | 46169 | 4 3/4" - 5" |
| HT525 | 46170 | 5 1/4" - 5 3/4" |
| HT575 | 46171 | 5 3/4" - 6 1/4" |
| HT625 | 46172 | 6 1/4" - 6 3/4" |
| HT725 | 46173 | 7 1/4" - 7 3/4" |
| HT850 | 46174 | 8 1/2" - 9" |

TURBO V-BAND

- Band width 7/8"
- Torque: 60 in-lb



| Part No. | Stk. Code | Nom. Dia. |
|----------|-----------|-----------|
| HV382 | 46196 | 3.82" |
| HV388 | 46197 | 3.88" |
| HV450 | 46198 | 4.5" |
| HV461 | 46199 | 4.61" |
| HV475 | 46200 | 4.75" |
| HV525 | 46201 | 5.25" |
| HV588 | 46202 | 5.88" |

CONSTANT TORQUE HEAVY DUTY

- 3/8" 410 stainless steel slotted head hex screw
- Band width 5/8"
- Torque: 90 in-lb



| Part No. | Stk. Code | Clamp Range |
|----------|-----------|-----------------|
| HK200 | 46180 | 1 1/4" - 2 1/8" |
| HK250 | 46181 | 1 3/4" - 2 5/8" |
| HK300 | 46182 | 2 1/4" - 3 1/8" |
| HK350 | 46183 | 2 3/4" - 3 5/8" |
| HK400 | 46184 | 3 1/4" - 4 1/8" |
| HK450 | 46185 | 3 3/4" - 4 5/8" |
| HK500 | 46186 | 4 1/4" - 5 1/8" |

SPRING LOADED T-BOLT

- T-Bolt spring load clamps have a stainless band, trunnion and liner
- Heavy duty large spring on spring-loaded T-Bolt clamp
- Special application sizes for charge-air-after cooled engine systems
- 1/2" plated hex nut
- Band width 3/4"
- Torque 150 in-lb



| Part No. | Stk. Code | Clamp Range |
|----------|-----------|------------------|
| HTS206 | 46403 | 2.06" - 2.37" |
| HTS213 | 46404 | 2.13" - 2.44" |
| HTS219 | 46405 | 2.19" - 2.50" |
| HTS225 | 46187 | 2 1/4" - 2 9/16" |
| HTS275 | 46188 | 2 3/4" - 3 1/16" |
| HTS306 | 46189 | 3 1/16" - 3 3/8" |
| HTS344 | 46190 | 3 7/16" - 3 3/4" |
| HTS356 | 46191 | 3 9/16" - 3 7/8" |
| HTS388 | 46192 | 3 7/8" - 4 3/16" |
| HTS406 | 46193 | 4 1/16" - 4 3/8" |
| HTS419 | 46194 | 4 3/16" - 4 1/2" |
| HTS456 | 46195 | 4 9/16" - 4 7/8" |



MUFFLER CLAMPS

- Muffler clamps are zinc plated for superior corrosion resistance
- Heavy duty U-Bolt and band construction

SADDLE CLAMPS

Tectran Saddle Muffler Clamps are designed with elongated and tapered holes that pull the legs around the pipe as the nuts tighten, making a tight seal. Other clamps' legs do not wrap around the pipe, they stay straight and the clamp only connects at two points

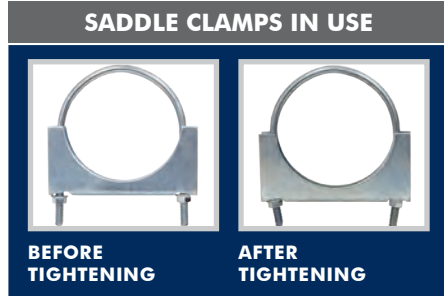

| Part No. | Stk. Code | Nominal Dia. |
|----------|-----------|--------------|
| MUC125R | 46327 | 1 1/4" |
| MUC175R | 46103 | 1 3/4" |
| MUC187R | 46104 | 1 7/8" |
| MUC2R | 46110 | 2" |
| MUC225R | 46106 | 2 1/4" |
| MUC25R | 46108 | 2 1/2" |
| MUC275R | 46109 | 2 3/4" |
| MUC3R | 46113 | 3" |
| MUC35R | 46112 | 3 1/2" |
| MUC4R | 46121 | 4" |
| MUC45R | 46116 | 4 1/2" |
| MUC5R | 46126 | 5" |

FLAT BAND CLAMPS



| Part No. | Stk. Code | Nominal Dia. |
|----------|-----------|--------------|
| MUC4F | 46117 | 4" |
| MUC5F | 46122 | 5" |
| MUC6F | 46328 | 6" |
| MUC7F | 46415 | 7" |

GUILLOTINE CLAMPS



| Part No. | Stk. Code | Nominal Dia. |
|----------|-----------|--------------|
| MUC35G | 46111 | 3 1/2" |
| MUC4G | 46118 | 4" |
| MUC45G | 46114 | 4 1/2" |
| MUC5G | 46123 | 5" |

EXHAUST CLAMPS

Each clamp includes:

- Metal band
- Spacer
- Two bolts
- Two reaction blocks

BUTT



| Part No. | Stk. Code | Description |
|----------|-----------|------------------------|
| HJ200 | 46408 | 2" Aluminized/Steel |
| HJ300 | 46409 | 3" Aluminized/Steel |
| HJ350 | 46410 | 3.50" Aluminized/Steel |
| HJ400 | 46411 | 4" Aluminized/Steel |
| HJ500 | 46412 | 5" Aluminized/Steel |
| HJ600 | 46413 | 6" Aluminized/Steel |
| HJS500 | 46414 | 5" Stainless Steel |

LAP



| Part No. | Stk. Code | Description |
|----------|-----------|------------------------|
| HL200 | 46350 | 2" Aluminized/Steel |
| HL250 | 46352 | 2.5" Aluminized/Steel |
| HL275 | 46353 | 2.75" Aluminized/Steel |
| HL300 | 46354 | 3" Aluminized/Steel |
| HL350 | 46355 | 3.50 Aluminized/Steel |
| HL400 | 46356 | 4" Aluminized/Steel |
| HL500 | 46358 | 5" Aluminized/Steel |
| HLS200 | 46360 | 2" Stainless Steel |
| HLS250 | 46362 | 2.50" Stainless Steel |
| HLS275 | 46363 | 2.75" Stainless Steel |
| HLS300 | 46364 | 3" Stainless Steel |
| HLS350 | 46365 | 3.50" Stainless Steel |
| HLS400 | 46366 | 4" Stainless Steel |
| HLS500 | 46368 | 5" Stainless Steel |
| HLS600 | 46369 | 6" Stainless Steel |

EASY-FORM

- Clamp wraps around an exhaust joint and is tightened with supplied nuts & bolts



| Part No. | Stk. Code | Description |
|----------|-----------|-----------------------|
| HNS200 | 46390 | 2" Stainless Steel |
| HNS225 | 46391 | 2.25" Stainless Steel |
| HNS250 | 46392 | 2.5" Stainless Steel |
| HNS275 | 46393 | 2.75" Stainless Steel |
| HNS300 | 46394 | 3" Stainless Steel |
| HNS350 | 46395 | 3.5" Stainless Steel |
| HNS400 | 46396 | 4" Stainless Steel |
| HNS500 | 46398 | 5" Stainless Steel |
| HNS600 | 46399 | 6" Stainless Steel |
| HNS700 | 46402 | 7" Stainless Steel |