

# TRUX

ACCESSORIES®

VOLUME 11  
CATALOG



HEADLIGHTS | WORK LAMPS | LIGHTING  
UNIVERSAL & WHEEL ACCESSORIES | FENDERS | EXHAUST | TRIMS



# ADD A **WOW** FACTOR TO YOUR SHOWROOM

WITH ONE OF OUR EXCITING CUSTOM DISPLAYS



**SLOTWALL**

**GONDOLA**

**MRD**



# WALL DISPLAYS

## WANT TO ADD A WOW FACTOR TO YOUR SHOWROOM?

Trux has developed a questionnaire that identifies your every need. With this questionnaire your account manager will create a custom wall display tailored to your answers. From there, Trux will build a product diagram and a suggested order for you to approve.

FOR MORE INFORMATION SEE PAGE 324!

# MRD DISPLAYS

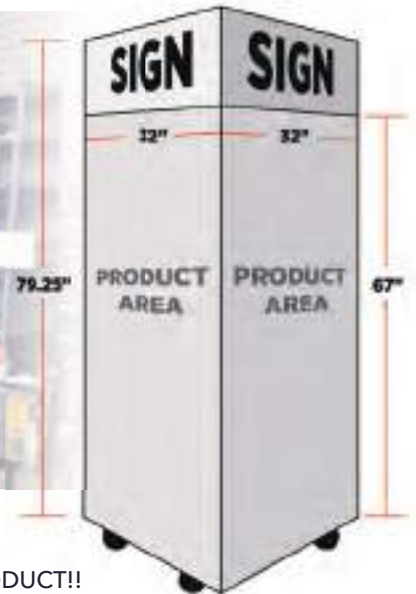

## WANT TO SHOWCASE ALL YOUR ACCESSORIES BUT HAVE LIMITED SPACE?

Our Mobile Retail Display only takes 32" x 32" of floor space BUT provides 60 SQUARE FEET OF PRODUCT!!

FOR MORE INFORMATION SEE PAGE 322!

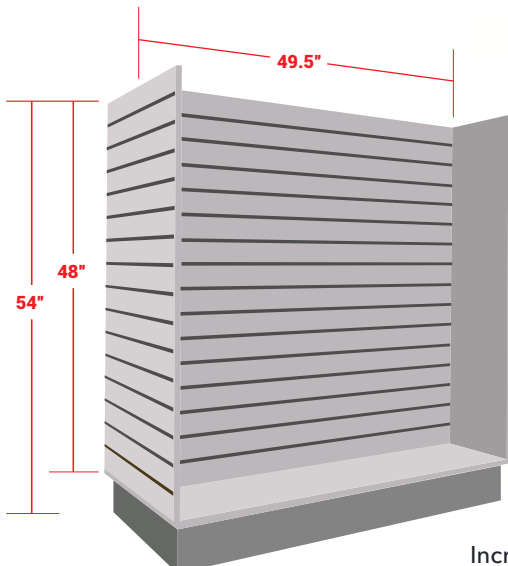

# GONDOLA DISPLAYS



## OPTIMIZE & INCREASE YOUR SALES

Increase your sales and optimize your retail space with Trux four-sided free-standing display by creating aisles of product and increasing exposure.

FOR MORE INFORMATION SEE PAGE 323!

**TRUX'S**

**HEAT**

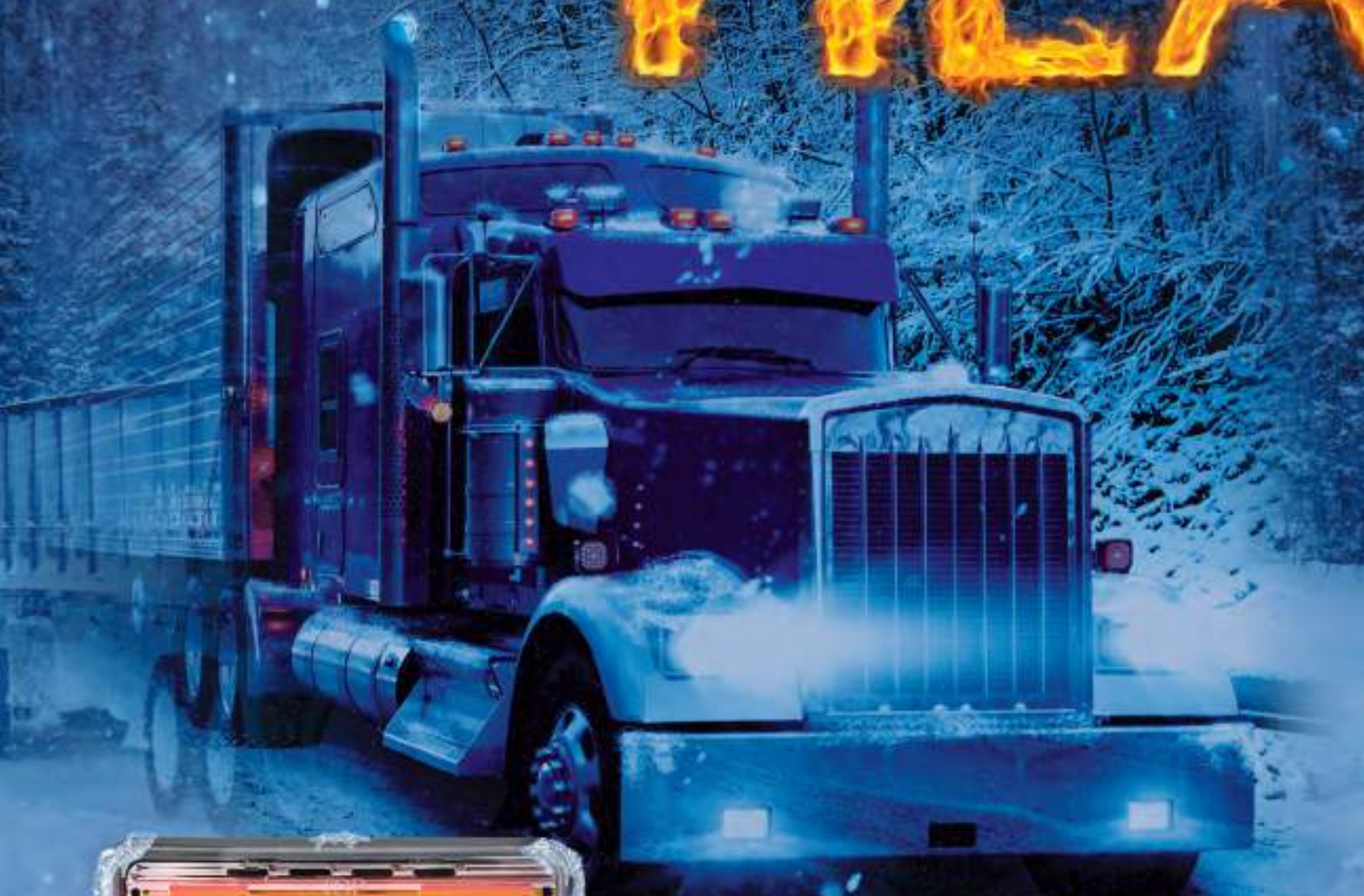

**4" x 6" LED PROJECTOR  
HEADLIGHTS WITH  
HEATED LENS**

**TLED-H12**  
LOW BEAM

**TLED-H11**  
HIGH BEAM

**DOT COMPLIANT** ✓

**QUICK HEAT TECHNOLOGY** ✓  
ACTIVATES AT 3°C (37.4° F)

**7 YEAR WARRANTY** ✓

**SEE PAGE 11**  
FOR MORE INFORMATION

# HEATED SERIES



**BREATHABLE MATERIAL**  
WATER & WIND RESISTANT



**MULTI-ZONE HEATING**  
UP TO 11\* HOURS OF HEAT  
\*HEAT DURATION VARIES BASED ON JACKET MODEL



**POWER BANK**  
RECHARGEABLE WITH USB



**INCLUDED**



**STYLES & SIZES**  
UP TO 3 STYLES  
BOMBER, SOFT SHELL, SAFETY PARKA



SIZES: M, L, XL, XXL

# HEATED APPAREL

**JACKETS**  
BOMBER, SOFT SHELL  
& SAFETY PARKA

**VEST**  
LINER

**GLOVES & MITTS**



**SEE PAGE 293**  
FOR MORE INFORMATION

**FOR MORE  
INFORMATION  
SEE PAGE 27**

**TLED-U118**

**TLED-U114**

**TLED-U112**

# **LED WORK WITH**



**AGRICULTURAL**



**DELIVERY VEHICLES**

**PERFECT FOR A WIDE RA**

# CUTTING EDGE TECHNOLOGY

WORK SMARTER, NOT HARDER



TLED-U106

TLED-W4

# WORK LAMPS STROBE



SERVICE VEHICLES



WRECKERS

## RANGE OF APPLICATIONS

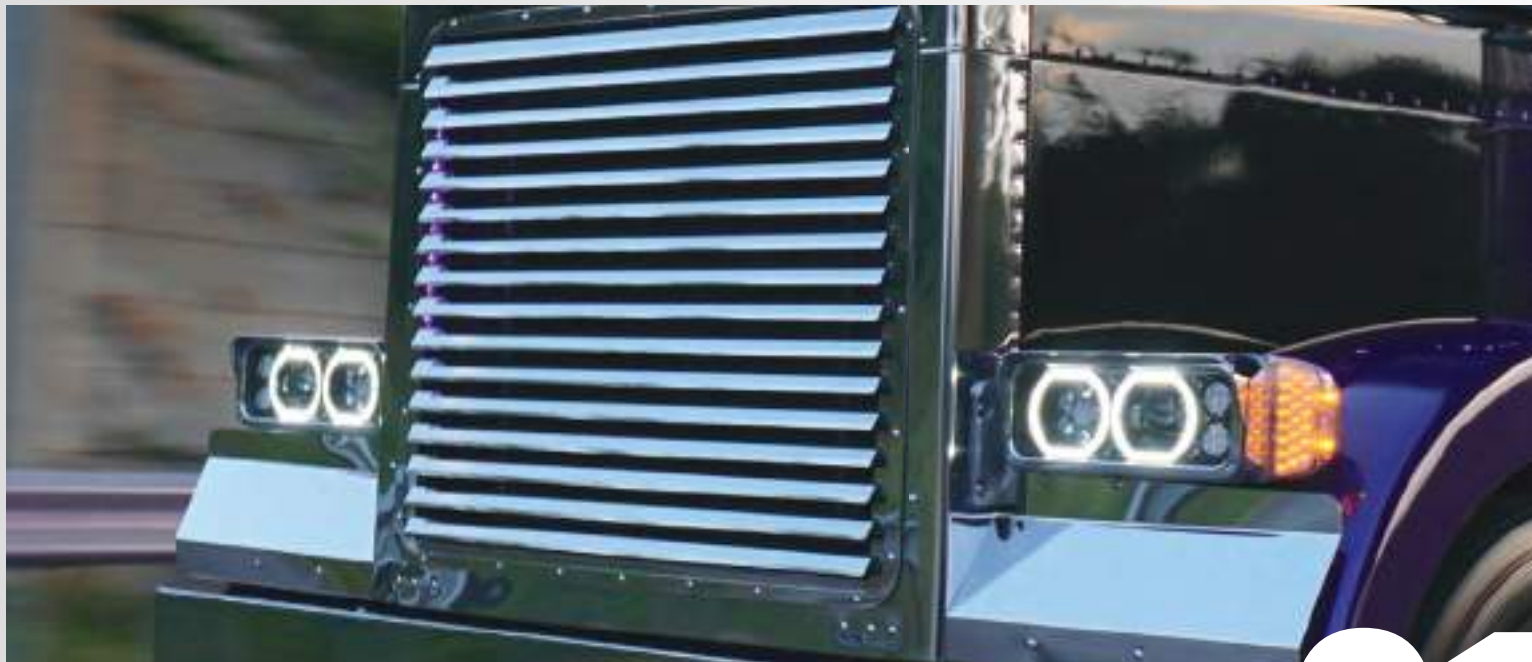

**UNIVERSAL LED PROJECTOR  
HEADLIGHT ASSEMBLIES**

**01**



**FTL. CASCADIA LED PROJECTOR  
HEADLIGHT ASSEMBLIES**

**05**



**4" X 6" HEATED LENS  
LED PROJECTOR HEADLIGHTS**

**11**



**RADIANT SERIES  
LED WORK LAMPS**

**23**



**STROBE SERIES  
LED WORK LAMPS**

**27**





**2" MINI LED WORK LAMP  
POS DISPLAY**

**31**



**CLASS 1  
LED WARNING LIGHTS**

**47**



**S,T&T TO BACK UP  
DUAL REVOLUTION**

**55**



**3/4" ROUND  
LED LIGHTING**

**82**



**GENERATION  
MARKER LEDS**

**89**



**ALL-IN-ONE WHEEL ACCESSORY KITS  
UNIVERSAL ACCESSORIES**

**119**



**30" MUD FLAP HANGERS**  
UNIVERSAL ACCESSORIES

**140**



**24" QUARTER FENDER KIT**  
FENDERS

**155**



**60" SMOOTH FLANGED**  
HALF FENDER

**159**



**STACK KITS**  
EXHAUST

**181**



**14" BOWTIE SUN VISOR**  
PETERBILT - STAINLESS

**199**



**ANGLED GRILLE BARS**  
KENWORTH - STAINLESS

**257**



**17" RAISED ROOF SUN VISOR**  
VOLVO - STAINLESS

**277**



**HEATED JACKETS**

**293**



**SLOTWALL DISPLAYS**

**324**

	<b>TABLE OF CONTENTS</b>
<b>01</b>	<b>HEADLIGHTS</b>
<b>23</b>	<b>WORK LAMPS</b>
<b>53</b>	<b>DUAL REVOLUTION</b>
<b>75</b>	<b>LED LIGHTING</b>
<b>113</b>	<b>LIGHTING ACCESSORIES</b>
<b>119</b>	<b>UNIVERSAL ACCESSORIES</b>
<b>155</b>	<b>FENDERS</b>
<b>181</b>	<b>EXHAUST</b>
<b>199</b>	<b>PETERBILT</b>
<b>235</b>	<b>KENWORTH</b>
<b>263</b>	<b>FREIGHTLINER</b>
<b>277</b>	<b>VOLVO</b>
<b>281</b>	<b>INTERNATIONAL</b>
<b>285</b>	<b>MACK</b>
<b>289</b>	<b>WESTERN STAR</b>
<b>293</b>	<b>MERCHANDISING</b>
<b>326</b>	<b>POLICIES</b>

# HEADLIGHT ASSEMBLIES

**REDESIGNED**

## UNIVERSAL LED PROJECTOR HEADLIGHT ASSEMBLIES

[ PATENTED DESIGN ]

### DESIGNED TO FIT

#### PETERBILT

379 1987-2007 378 1988-2007  
365 2008-2009 357 1986-2008

#### KENWORTH

W900 1984+  
T800 1987+  
T600 1986-2007

#### FREIGHTLINER CLASSIC 1988-2007

#### WESTERN STAR

6900 Series  
4900 Series  
4800 Series

**TOP  
SELLER**



▲  
CHROME  
LED PROJECTOR  
**TLED-H120** Driver Side  
**TLED-H121** Passenger Side



▲  
BLACK  
LED PROJECTOR  
**TLED-H122** Driver Side  
**TLED-H123** Passenger Side

### TECHNICAL SPECIFICATIONS

RAW LUMENS	Low: 2400 Lumens High: 1400 Lumens
EFFECTIVE LUMENS	Low: 520 Lumens High: 710 Lumens
OPERATING VOLTAGE	9-24 Volts (DRL Compatible)
LED POWER (W)	Low: 42 Watts High: 30 Watts
CURRENT DRAW	Low: 2.25 Amps @ 12 Volts High: 2.1 Amps @ 12 Volts

DAYTIME (A)	0.16 Amps
MARKER (A)	0.44 Amps
LENS MATERIAL	Polycarbonate Lens with Waterborne NLS Curable Coating for UV Protection
HOUSING MATERIAL	Polypropylene
WATERPROOF RATING	IP66 Rating
COMPLIANCE	DOT SAE   FMVSS-108   CMVSS-108
WARRANTY	3 Years

### FEATURES & BENEFITS

- DOT Compliant
- Meets FMVSS-108 & CMVSS-108 Standards
- Projector Technology for a Wider Beam
- Patented Design
- Halo Accents
- Integrated Traditional Visor
- Sold Individually
- 3 Year Warranty

### FUNCTIONS



### WIRING



Wiring configurations for both Marker & Daytime Running Functions can be viewed online or in the provided Installation Guides that are found in the Retail Box.

### INCLUDED ACCESSORIES



**HOUSING BUCKET**  
Included for installation on Kenworth, Freightliner & Western Star Models.



**TOP VIEW**  
Integrated traditional visor for added style. Replacement visor **TU-1043** is now available, see pg 114.

### OEM REPLACEMENT



Replaces current OEM  
4" x 6" Headlight  
Configuration

⚠ WARNING: Cancer and Reproductive Harm - [www.p65warnings.ca.gov](http://www.p65warnings.ca.gov)

**SAFETY** NEVER HAD  
**THIS MUCH STYLE**



# HEADLIGHT ASSEMBLIES

## "RETRO SERIES" LED PROJECTOR HEADLIGHT ASSEMBLIES

### DESIGNED TO FIT

#### PETERBILT

**379** All Years **389** All Years **388** All Years  
**378** All Years **367** All Years **365** All Years  
**357** All Years **359** All Years



▲ CHROME  
**WITH HOUSING**  
**TLED-H104** Driver Side  
**TLED-H105** Passenger Side

#### CUSTOM

DOUBLE ROUND 5.75"  
 HEADLIGHT CONFIGURATIONS



▲ CHROME  
**WITH HOUSING & MOUNTING BRACKET**  
**TLED-H106** Driver Side  
**TLED-H107** Passenger Side

### TECHNICAL SPECIFICATIONS

RAW LUMENS	Low: 1800 Lumens High: 2700 Lumens	COLOR TEMPERATURE	6800 Kelvin
EFFECTIVE LUMENS	Low: 630 Lumens High: 900 Lumens	LENS MATERIAL	Polycarbonate
OPERATING VOLTAGE	9-24 Volts (DRL Compatible)	HOUSING MATERIAL	Polypropylene   304 Stainless (Bucket)
LED POWER (W)	Low: 6.5 Watts High: 12.8 Watts	WATERPROOF RATING	IP66 Rating
CURRENT DRAW	Low: 1.1 Amps @ 12.8 Volts High: 1.3 Amps @ 12.8 Volts	COMPLIANCE	DOT SAE   FMVSS-108   CMVSS-108
		WARRANTY	3 Years

### FEATURES & BENEFITS

- DOT Compliant
- Meets FMVSS-108 & CMVSS-108 Standards
- Projector Technology for a Wider Beam
- Halo Accents
- 304 Stainless Housing Bucket Included
- Sold Individually
- 3 Year Warranty

### FUNCTIONS



### WIRING

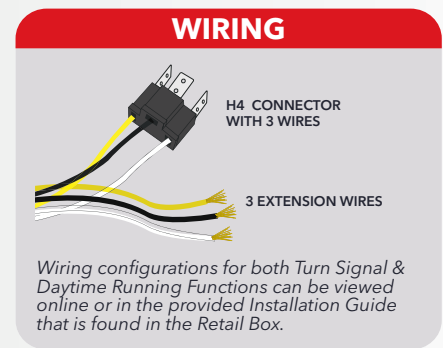

### INCLUDED ACCESSORIES



**304 STAINLESS HOUSING BUCKET**  
 Included in all "Retro Series" LED Projector Headlight Retail Boxes.



**304 STAINLESS MOUNTING BRACKET**  
 Included for TLED-H106 & TLED-H107 Models ONLY.  
 Mounting Brackets are also sold as a Pair (TU-1045).



### REPLACEMENT



⚠ WARNING: Cancer and Reproductive Harm - [www.p65warnings.ca.gov](http://www.p65warnings.ca.gov)

# **OL'SKUL** STYLING WITH **LATEST TECHNOLOGY**



# HEADLIGHT ASSEMBLIES

## FREIGHTLINER CASCADIA LED PROJECTOR HEADLIGHT ASSEMBLIES | FOG LIGHTS



DESIGNED TO FIT  
2008-2018 CASCADIA MODELS  
EXCLUDES 2017+ EVOLUTION MODELS

### HEADLIGHT

**CHROME**  
**TLED-H66** Driver Side  
**TLED-H67** Passenger Side

**BLACK**  
**TLED-H68** Driver Side  
**TLED-H69** Passenger Side

### TECHNICAL SPECIFICATIONS

RAW LUMENS	Low: 3290 Lumens High: 5972 Lumens
EFFECTIVE LUMENS	Low: 1000 Lumens High: 1500 Lumens
OPERATING VOLTAGE	12 Volts
LED POWER	Low: 17.76 Watts High: 11.4 Watts
CURRENT DRAW	Low: 1.48 Amps @ 12 Volts High: 0.95 Amps @ 12 Volts
DAYTIME (W)	3.9 Watts
TURN SIGNAL (W)	4.32 Watts
LENS MATERIAL	Polycarbonate
HOUSING MATERIAL	Polypropylene
WATERPROOF RATING	IP56 Rating
COMPLIANCE	DOT SAE   FMVSS-108   CMVSS-108
WARRANTY	3 Years

### FEATURES & BENEFITS

- DOT Compliant
- Meets FMVSS-108 & CMVSS-108 Standards
- Fog Lights are SAE J583 Compliant
- No Programming Needed
- Plug & Play Application
- Projector Technology for a Wider Beam
- Dual Function Daytime Running to Turn Signal Function (Headlight)
- Sold Individually
- 3 Year Warranty

**NEW**



DESIGNED TO FIT  
2008-2016 CASCADIA MODELS

### FOG LIGHT

**CHROME**  
**TLED-H39** Driver Side  
**TLED-H42** Passenger Side

**BLACK**  
**TLED-H43** Driver Side  
**TLED-H44** Passenger Side

### TECHNICAL SPECIFICATIONS

RAW LUMENS (PAIR)	1400 Lumens
EFFECTIVE LUMENS (PAIR)	502 Lumens
OPERATING VOLTAGE	12 Volts
LED POWER	6.6 Watts
CURRENT DRAW	0.55 Amps @ 12.8 Volts
LENS MATERIAL	Polycarbonate
HOUSING MATERIAL	Polypropylene 30% Glass Fibre Polyamide
WATERPROOF RATING	IP67 Rating
COMPLIANCE	SAE J583
DIRECT REPLACEMENT	Driver OEM # A06-51909-000 Passenger OEM # A06-51909-001
WARRANTY	3 Years

Trux's Cascadia Headlight Assemblies and Fog Lights are the perfect team when looking to upgrade functionality, appearance and safety. Join the Cascadia Revolution - it's time to make a statement to the world that you're up to date with Safety, Technology and Style.

### FUNCTIONS

DAYTIME RUNNING  
FUNCTION



TURN SIGNAL  
FUNCTION

Headlight Assembly Wiring configurations for both Turn Signal & Daytime Running Functions can be viewed online or in the provided Installation Guide that is found in the Retail Box.

### WIRING

HEADLIGHT

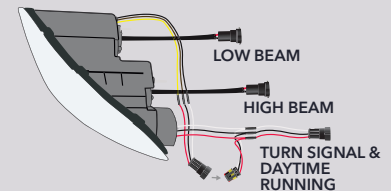

FOG LIGHT

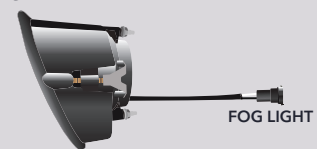

⚠ WARNING: Cancer and Reproductive Harm - [www.p65warnings.ca.gov](http://www.p65warnings.ca.gov)



THE **PERFECT** COMBO  
SUPER BRIGHT PLUG & PLAY



# HEADLIGHT ASSEMBLIES

## FREIGHTLINER CENTURY PROJECTOR HEADLIGHT ASSEMBLIES (1996-2010)



▲  
CHROME  
**LED PROJECTOR**  
**TLED-H49** Driver Side  
**TLED-H50** Passenger Side

**HALOGEN PROJECTOR**  
**TLED-H13** Driver Side  
**TLED-H14** Passenger Side



▲  
BLACK  
**LED PROJECTOR**  
**TLED-H57** Driver Side  
**TLED-H58** Passenger Side

**HALOGEN PROJECTOR**  
**TLED-H15** Driver Side  
**TLED-H16** Passenger Side

### LED PROJECTOR TECHNICAL SPECIFICATIONS

RAW LUMENS	Low: 3290 Lumens High: 5972 Lumens
EFFECTIVE LUMENS	Low: 1000 Lumens High: 1500 Lumens
OPERATING VOLTAGE	12 Volts
LED POWER	Low: 13.5 Watts High: 7.5 Watts
CURRENT DRAW	Low: 1.4 Amps @ 12 Volts High: 0.76 Amps @ 12 Volts
DAYTIME (W)	0.4 Watts
TURN SIGNAL (W)	0.4 Watts
SIDE MARKER (W)	0.1 Watts
LENS MATERIAL	Polycarbonate
HOUSING MATERIAL	Polypropylene
WATERPROOF RATING	IP56 Rating
COMPLIANCE	DOT SAE   FMVSS-108   CMVSS-108
WARRANTY	2 Years on LEDs only

### HALOGEN PROJECTOR TECHNICAL SPECIFICATIONS

RAW LUMENS	Low: 2200 Lumens High: 5900 Lumens
EFFECTIVE LUMENS	Low: 1100 Lumens High: 1300 Lumens
OPERATING VOLTAGE	12 Volts
HALOGEN POWER	Low: 55 Watts High: 60 Watts
CURRENT DRAW	Low: 4.2 Amps @ 12 Volts High: 4.3 Amps @ 12 Volts
DAYTIME (W)	0.4 Watts
TURN SIGNAL (W)	0.4 Watts
SIDE MARKER (W)	0.1 Watts
LENS MATERIAL	Polycarbonate
HOUSING MATERIAL	Polypropylene
WATERPROOF RATING	IP56 Rating
HALOGEN REPLACEMENT	Low: H7 High: HB3-9005
COMPLIANCE	DOT SAE   FMVSS-108   CMVSS-108
WARRANTY	2 Years on LEDs only

### FEATURES & BENEFITS

- DOT Compliant
- Meets FMVSS-108 & CMVSS-108 Standards
- Dual Function Daytime Running to Turn Signal Function
- Projector Technology for a Wider Beam
- Sold Individually
- 2 Year Warranty on LED Projector & LED Marker only

### FUNCTIONS



### WIRING

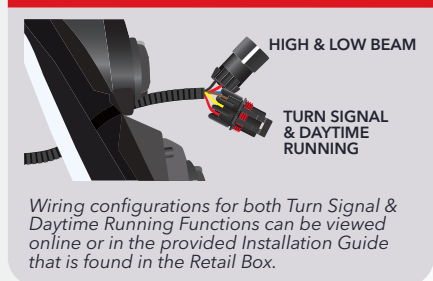

⚠ WARNING: Cancer and Reproductive Harm - [www.p65warnings.ca.gov](http://www.p65warnings.ca.gov)

YOUR **TRUCK** WILL BE  
AHEAD BY A CENTURY



# HEADLIGHT ASSEMBLIES

**REDESIGNED**

## VOLVO VN/VNL PROJECTOR HEADLIGHT ASSEMBLIES (2003-2017)



**CHROME**  
**LED PROJECTOR**  
**TLED-H17** Driver Side  
**TLED-H18** Passenger Side

### LED PROJECTOR TECHNICAL SPECIFICATIONS

RAW LUMENS	Low: 2750 Lumens High: 6450 Lumens
EFFECTIVE LUMENS	Low: 1000 Lumens High: 1500 Lumens
OPERATING VOLTAGE	12 Volts
LED POWER	Low: 15 Watts High: 9 Watts
CURRENT DRAW	Low: 1.41 Amps @ 12 Volts High: 0.72 Amps @ 12 Volts
DAYTIME (W)	0.6 Watts
TURN SIGNAL (W)	1 Watt
LENS MATERIAL	Polycarbonate
HOUSING MATERIAL	Polypropylene
WATERPROOF RATING	IP56 Rating
COMPLIANCE	DOT SAE   FMVSS-108   CMVSS-108
WARRANTY	2 Years on LEDs only

### FEATURES & BENEFITS

- DOT Compliant
- Meets FMVSS-108 & CMVSS-108 Standards
- No Programming Needed
- Plug & Play Application
- Projector Technology for a Wider Beam
- Halo Accents
- Dual Function Daytime Running to Turn Signal Function
- Sold Individually
- 2 Year Warranty on LED Projector & LED Marker only



**BLACK**  
**LED PROJECTOR**  
**TLED-H19** Driver Side  
**TLED-H20** Passenger Side

**HALOGEN PROJECTOR**  
**TLED-H45** Driver Side  
**TLED-H46** Passenger Side

**HALOGEN PROJECTOR**  
**TLED-H54** Driver Side  
**TLED-H55** Passenger Side

### HALOGEN PROJECTOR TECHNICAL SPECIFICATIONS

RAW LUMENS	Low: 2270 Lumens High: 5700 Lumens
EFFECTIVE LUMENS	Low: 1100 Lumens High: 1150 Lumens
OPERATING VOLTAGE	12 Volts
HALOGEN POWER	Low: 55 Watts High: 55 Watts
CURRENT DRAW	Low: 4.08 Amps @ 12 Volts High: 4.71 Amps @ 12 Volts
DAYTIME (W)	0.6 Watts
TURN SIGNAL (W)	1 Watt
LENS MATERIAL	Polycarbonate
HOUSING MATERIAL	Polypropylene
WATERPROOF RATING	IP56 Rating
COMPLIANCE	DOT SAE   FMVSS-108   CMVSS-108
WARRANTY	2 Years on LEDs only

### FUNCTIONS



### WIRING



Wiring configurations for both Turn Signal & Daytime Running Functions can be viewed online or in the provided Installation Guide that is found in the Retail Box. Plug & Play.

**⚠ WARNING: Cancer and Reproductive Harm - www.p65warnings.ca.gov**

# PLUG & PLAY

WITH NO DOWNTIME



# HEADLIGHTS

## 4" X 6" HEATED LED PROJECTOR LOW BEAM | HIGH BEAM

**NEW**



CHROME  
LED PROJECTOR  
**TLED-H12** Low Beam  
**TLED-H11** High Beam

### TECHNICAL SPECIFICATIONS

LED POWER	27 Watts
RAW LUMENS	Low: 1300 Lumens High: 2400 Lumens
EFFECTIVE LUMENS	Low: 850 Lumens High 1150 Lumens
BEAM PATTERN	TLED-H12: Low Beam TLED-H11: High Beam
OPERATING VOLTAGE	9-24 Volts (DRL Compatible)
CURRENT DRAW	2.3 Amps @ 12 Volts
COLOR TEMPERATURE	6000 Kelvin
INTERIOR	Chrome
HOUSING MATERIAL	Aluminum Alloy
LENS MATERIAL	Polycarbonate
WATERPROOF RATING	IP67 Rating
COMPLIANCE	DOT SAE   FMVSS-108   CMVSS-108
WARRANTY	7 Years

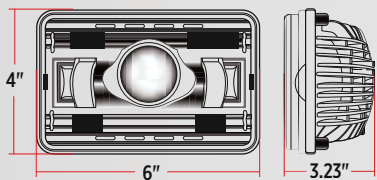

### RETROFIT

LOW BEAM	HIGH BEAM
➤ 4652	➤ 4651
➤ H4652	➤ H4651
➤ H4656	➤ H5051
➤ H4662	
➤ H4739	
➤ H5062	

### WIRING

HIGH BEAM H4 CONNECTOR  
(2 Wires)

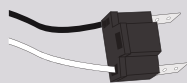

LOW BEAM H4 CONNECTOR  
(3 Wires)

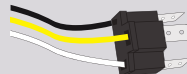

Plug & Play

### BEAM PATTERN

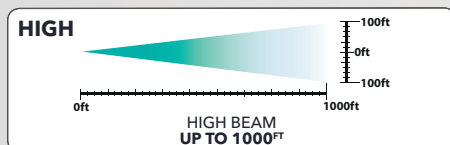
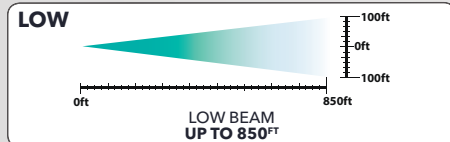

**DOT  
COMPLIANT**

LOW BEAM  
**1300  
LUMENS**

HIGH BEAM  
**2400  
LUMENS**



## BEAM PATTERN COMPARISON



Trux's Heated LED Projector Headlight's Beam Pattern **MEETS** Stringent DOT Standards compared to the leading competitor's Beam Pattern which does not!

**QUICK HEAT TECHNOLOGY**  
HEAT ELEMENT ACTIVATES WHEN TEMPERATURE REACHES 3°C (37.4°F)

**LED PROJECTOR TECHNOLOGY**

**DOT COMPLIANT**

**7 YEAR WARRANTY**

⚠ WARNING: Cancer and Reproductive Harm - [www.p65warnings.ca.gov](http://www.p65warnings.ca.gov)



**TRUX'S LED HEADLIGHTS WITH  
HEATED LENS  
4" x 6" HEADLIGHT POS DISPLAYS**

**TLED-H12  
TRX-241  
LOW BEAM**



**TLED-H11  
TRX-240  
HIGH BEAM**



**SEE PAGE 317 FOR MORE INFORMATION**

# LED HEADLIGHTS

A light emitting diode (LED) uses electric current to emit light through a semi conductor (two-lead) device.

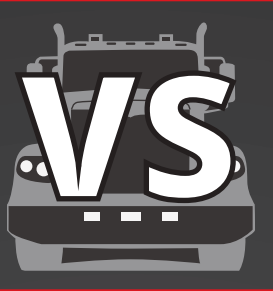

# HALOGEN HEADLIGHTS

Halogen headlight bulbs use halogen gas to react chemically with the tungsten that evaporates from the burning filament.

## VISIBILITY

IF OTHER TRUCKERS CAN SEE THE DIFFERENCE,  
**SO CAN YOU!**

# 20% GREATER

PERCEPTION OF BRIGHTNESS

! Road tests have discovered that drivers, driving with LED lights perceived to see the road 20% brighter than driving with halogen lights.

LED HEADLIGHTS ARE THE  
**MOST LUMINOUS**

! A comparison of photometric beam pattern intensity across 3 different test routes in Ann Arbor, MI.

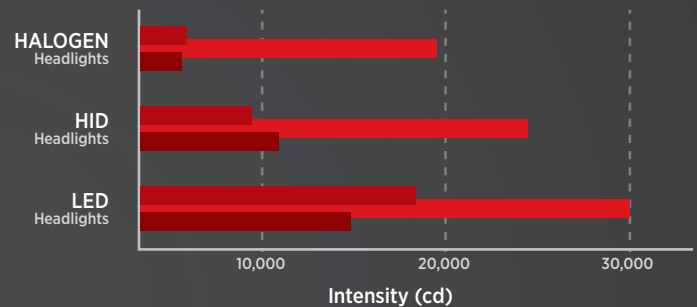

## COST

### DECREASE YOUR DOWNTIME

! Not having to change your headlight often decreases the downtime on the job.

**UP TO 50,000 HOURS**  
LIFETIME AVERAGE OF LED BULBS

**UP TO 1,000 HOURS**  
LIFETIME AVERAGE OF HALOGEN BULBS

**CHANCES ARE**  
YOU WILL BE REPLACING YOUR TRUCK  
BEFORE REPLACING YOUR LED BULBS

## SAFETY

**FEELING SAFER**  
WHILE DRIVING AT NIGHT

### OBSTACLES AHEAD

! Several Road Studies indicate that LED Headlights improve the visibility of lane markings (white lines) and other hazards (pedestrians, road signs).

## UPGRADE TO LED

- 👍 20% GREATER PERCEPTION OF BRIGHTNESS
- 👍 MOST LUMINOUS IN THE INDUSTRY
- 👍 SAFER DRIVING AT NIGHT FROM IMPROVED VISIBILITY
- 👍 UP TO 50,000 AVERAGE LIFETIME HOURS
- 👍 UP TO 12x LESS ENERGY THAN HALOGEN

## ENERGY

**LESS ENERGY**  
MEANS MORE LIGHTS!

**UP TO 12X**  
**LESS ENERGY**  
USAGE THAN HALOGEN BULBS

! LED bulbs draw less energy from your truck than regular Halogen bulbs. Drawing less energy prolongs the life of your truck's starter, battery and alternator.



# 4" X 6" LED PROJECTOR

LOW BEAM | HIGH BEAM



▲  
**CHROME**  
**LED PROJECTOR**  
**TLED-H6** Low Beam  
**TLED-H7** High Beam

▲  
**BLACK**  
**LED PROJECTOR**  
**TLED-H73** Low Beam  
**TLED-H75** High Beam

## TECHNICAL SPECIFICATIONS

LED POWER	27 Watts	COLOR TEMPERATURE	6000 Kelvin
RAW LUMENS	Low: 1300 Lumens High: 2400 Lumens	INTERIOR	Black or Chrome
EFFECTIVE LUMENS	Low: 850 Lumens High 1150 Lumens	HOUSING MATERIAL	Aluminum Alloy
OPERATING VOLTAGE	9-24 Volts (DRL Compatible)	LENS MATERIAL	Polycarbonate
CURRENT DRAW	2.3 Amps @ 12 Volts	WATERPROOF RATING	IP67 Rating
		COMPLIANCE	DOT SAE   FMVSS-108   CMVSS-108
		WARRANTY	7 Years

- RETROFIT**
- |                 |         |                  |
|-----------------|---------|------------------|
| <b>LOW BEAM</b> |         | <b>HIGH BEAM</b> |
| ➤ 4652          | ➤ H4739 | ➤ 4651           |
| ➤ H4652         | ➤ H5062 | ➤ H4651          |
| ➤ H4656         |         | ➤ H5051          |
| ➤ H4662         |         |                  |

### WIRING

**HIGH BEAM H4 CONNECTOR**  
(2 Wires)

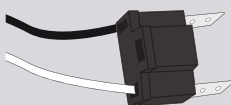

**LOW BEAM H4 CONNECTOR**  
(3 Wires)

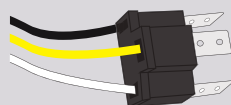

Plug & Play

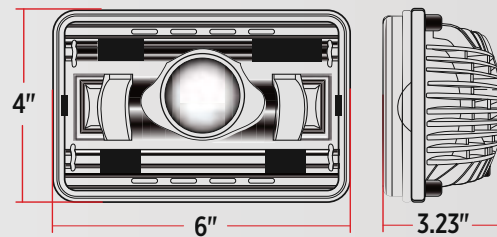

**DOT COMPLIANT**    **LOW BEAM 1300 LUMENS**    **HIGH BEAM 2400 LUMENS**

### BEAM PATTERN

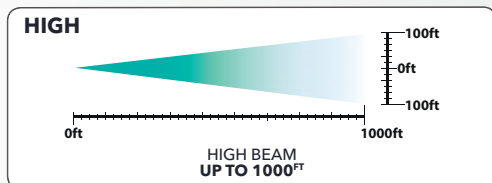
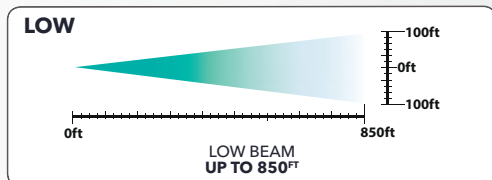

⚠ WARNING: Cancer and Reproductive Harm - [www.p65warnings.ca.gov](http://www.p65warnings.ca.gov)

# HEADLIGHTS

## 4" X 6" LED REFLECTOR LOW BEAM | HIGH BEAM



CHROME  
**TLED-H2** Low Beam

### TECHNICAL SPECIFICATIONS

LED POWER	9 Watts
RAW LUMENS	1100 Lumens
EFFECTIVE LUMENS	670 Lumens
BEAM PATTERN	Low Beam
DIODES	2 Diodes
OPERATING VOLTAGE	9-24 Volts (DRL Compatible)
CURRENT DRAW	0.9 Amps @ 12 Volts
COLOR TEMPERATURE	6800 Kelvin
HOUSING MATERIAL	Aluminum Die Cast
LENS MATERIAL	Polycarbonate
WATERPROOF RATING	IP67 Rating
COMPLIANCE	DOT SAE   FMVSS-108   CMVSS-108
WARRANTY	5 Years

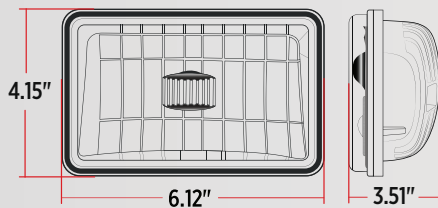

### RETROFIT

- 4652      ➤ H4739
- H4652    ➤ H5062
- H4656
- H4662

### BEAM PATTERN

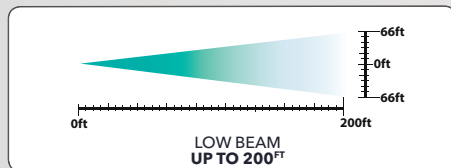

**DOT**  
COMPLIANT

LOW BEAM  
**1100**  
LUMENS

### WIRING

H4 CONNECTOR  
(3 Wires)

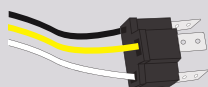

Plug & Play



CHROME  
**TLED-H1** High Beam

### TECHNICAL SPECIFICATIONS

LED POWER	9 Watts
RAW LUMENS	1700 Lumens
EFFECTIVE LUMENS	670 Lumens
BEAM PATTERN	High Beam
DIODES	2 Diodes
OPERATING VOLTAGE	9-24 Volts (DRL Compatible)
CURRENT DRAW	1 Amp @ 12 Volts
COLOR TEMPERATURE	6800 Kelvin
HOUSING MATERIAL	Aluminum Die Cast
LENS MATERIAL	Polycarbonate
WATERPROOF RATING	IP67 Rating
COMPLIANCE	DOT SAE   FMVSS-108   CMVSS-108
WARRANTY	5 Years

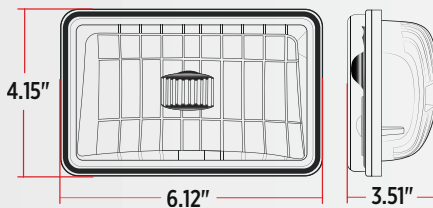

### RETROFIT

- 4651
- H4651
- H5051

### BEAM PATTERN

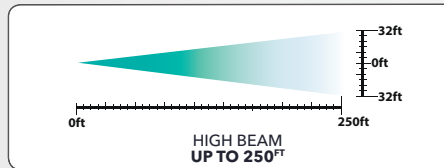

**DOT**  
COMPLIANT

HIGH BEAM  
**1700**  
LUMENS

### WIRING

H4 CONNECTOR  
(2 Wires)



Plug & Play

⚠ WARNING: Cancer and Reproductive Harm - www.p65warnings.ca.gov



# TRUX'S LED REFLECTOR 4" x 6" HEADLIGHTS

**HALOGEN  
HEADLIGHT**

**LED STANDARD  
HEADLIGHT**

**VS**

TRUX'S LED REFLECTOR HEADLIGHTS ARE PERFECT FOR OWNER OPERATORS OR FLEETS LOOKING FOR A HEADLIGHT SIGNIFICANTLY BRIGHTER THAN THE STANDARD HALOGENS. THE UPGRADE RELIES ON THE FACT THAT LED HEADLIGHTS ARE MORE RELIABLE, EFFICIENT AND ILLUMINATE A BRIGHT WHITE LIGHT IN COMPARISON TO HALOGEN MODELS THAT ILLUMINATE A DIM YELLOW LIGHT.



**TLED-H1**  
HIGH BEAM  
9-24v DRL COMPATIBLE  
1700 LUMENS

**TLED-H2**  
LOW BEAM  
DRL COMPATIBLE 9-24v  
1100 LUMENS

**LED REFLECTOR TECHNOLOGY**



**1700 LUMENS (HIGH BEAM)**



**1100 LUMENS (LOW BEAM)**



**DOT COMPLIANT**



# HEADLIGHTS

## 4" X 6" OFF ROAD LED COMBINATION HIGH & LOW BEAM

**OFF ROAD**



CHROME  
**TLED-H71** High & Low Beam

**TECHNICAL SPECIFICATIONS**

LED POWER	Low: 15 Watts High: 45 Watts
RAW LUMENS	Low: 1500 Lumens High: 3000 Lumens
EFFECTIVE LUMENS	Low: 1000 Lumens High: 2000 Lumens
BEAM PATTERN	Combination High & Low
DIODES	15 Diodes
OPERATING VOLTAGE	12-24 Volts
CURRENT DRAW	2.44 Amps @ 12 Volts
COLOR TEMPERATURE	6500 Kelvin
HOUSING MATERIAL	Aluminum Die Cast
LENS MATERIAL	Polycarbonate
WATERPROOF RATING	IP67 Rating
COMPLIANCE	Off Road Use Only
WARRANTY	1 Year

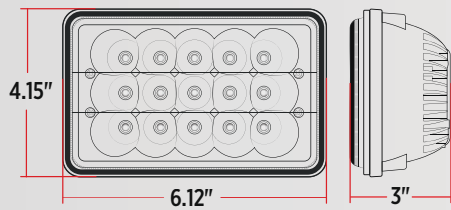

**RETROFIT**

- H6545
- H4666
- HP6545
- H4668

**BEAM PATTERN**

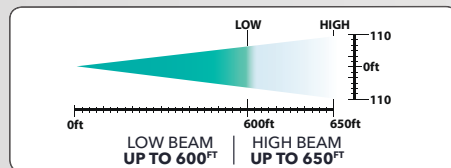

**OFF ROAD USE ONLY**

**LOW BEAM 1500 LUMENS**

**HIGH BEAM 3000 LUMENS**

**WIRING**

H4 CONNECTOR  
(3 Wires)



Plug & Play

**OFF ROAD**



BLACK  
**TLED-H5** High & Low Beam

**TECHNICAL SPECIFICATIONS**

LED POWER	Low: 15 Watts High: 45 Watts
RAW LUMENS	Low: 1500 Lumens High: 3000 Lumens
EFFECTIVE LUMENS	Low: 1000 Lumens High: 2000 Lumens
BEAM PATTERN	Combination High & Low
DIODES	15 Diodes
OPERATING VOLTAGE	12-24 Volts
CURRENT DRAW	2.44 Amps @ 12 Volts
COLOR TEMPERATURE	6500 Kelvin
HOUSING MATERIAL	Aluminum Die Cast
LENS MATERIAL	Polycarbonate
WATERPROOF RATING	IP67 Rating
COMPLIANCE	Off Road Use Only
WARRANTY	1 Year

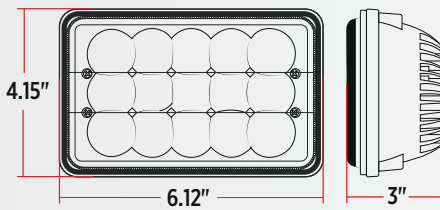

**RETROFIT**

- H6545
- H4666
- HP6545
- H4668

**BEAM PATTERN**

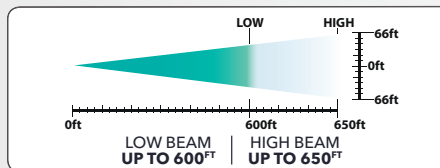

**OFF ROAD USE ONLY**

**LOW BEAM 1500 LUMENS**

**HIGH BEAM 3000 LUMENS**

**WIRING**

H4 CONNECTOR  
(3 Wires)



Plug & Play

**WARNING:** Cancer and Reproductive Harm - [www.p65warnings.ca.gov](http://www.p65warnings.ca.gov)

# 5.75" LED PROJECTOR WITH HALO ACCENTS

LOW BEAM | HIGH BEAM



▲ CHROME

## TLED-H63 Low Beam

### TECHNICAL SPECIFICATIONS

LED POWER	22 Watts
RAW LUMENS	1500 Lumens
EFFECTIVE LUMENS	1200 Lumens
BEAM PATTERN	Low Beam
DIODES	1 Diode
OPERATING VOLTAGE	10-30 Volts
CURRENT DRAW	1.85 Amps @ 12 Volts
COLOR TEMPERATURE	6000 Kelvin
HOUSING MATERIAL	Aluminum Die Cast
LENS MATERIAL	Polycarbonate
WATERPROOF RATING	IP67 Rating
COMPLIANCE	DOT SAE   FMVSS-108   CMVSS-108
WARRANTY	1 Year

▲ CHROME

## TLED-H56 High Beam

### TECHNICAL SPECIFICATIONS

LED POWER	22 Watts
RAW LUMENS	1500 Lumens
EFFECTIVE LUMENS	1200 Lumens
BEAM PATTERN	High Beam
DIODES	1 Diode
OPERATING VOLTAGE	10-30 Volts
CURRENT DRAW	1.85 Amps @ 12 Volts
COLOR TEMPERATURE	6000 Kelvin
HOUSING MATERIAL	Aluminum Die Cast
LENS MATERIAL	Polycarbonate
WATERPROOF RATING	IP67 Rating
COMPLIANCE	DOT SAE   FMVSS-108   CMVSS-108
WARRANTY	1 Year

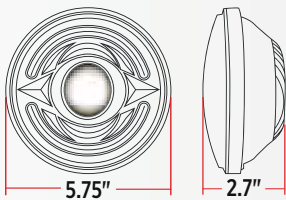

**RETROFIT**  
↘ H5006

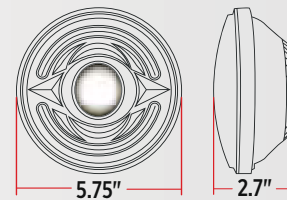

**RETROFIT**  
↘ H5001

### BEAM PATTERN

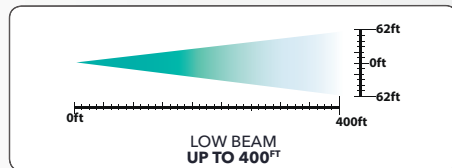

**DOT**  
COMPLIANT

**LOW BEAM**  
**1500**  
LUMENS

**WIRING**

H4 CONNECTOR  
(3 Wires with Extra Red Wire  
For Halo Function)

Plug & Play

### BEAM PATTERN

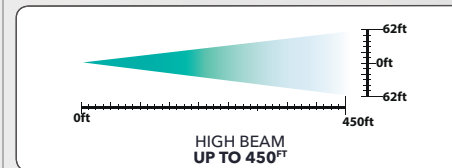

**DOT**  
COMPLIANT

**HIGH BEAM**  
**1500**  
LUMENS

**WIRING**

H4 CONNECTOR  
(3 Wires with Extra Red Wire  
For Halo Function)

Plug & Play

# HEADLIGHTS

## 5" X 7" LED PROJECTOR WITH HALO - COMBINATION HIGH & LOW BEAM



CHROME  
**TLED-H4** High & Low Beam

### TECHNICAL SPECIFICATIONS

LED POWER	Low: 9 Watts High: 15 Watts
RAW LUMENS	Low: 1890 Lumens High: 2600 Lumens
EFFECTIVE LUMENS	Low: 700 Lumens High: 800 Lumens
BEAM PATTERN	Combination High & Low
DIODES	7 Diodes
OPERATING VOLTAGE	9-24 Volts (DRL Compatible)
CURRENT DRAW	Low: 0.7 Amps @ 12.8 Volts High: 1.2 Amps @ 12.8 Volts
COLOR TEMPERATURE	6800 Kelvin
HOUSING MATERIAL	Aluminum Die Cast
LENS MATERIAL	Polycarbonate
WATERPROOF RATING	IP67 Rating
COMPLIANCE	DOT SAE   FMVSS-108   CMVSS-108
WARRANTY	7 Years

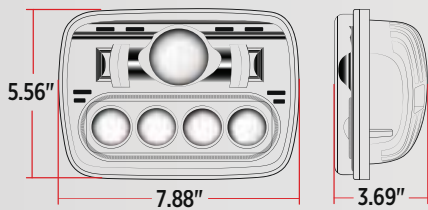

### RETROFIT

- 6052
- 6053
- H6054
- HD6054
- HP6054

### BEAM PATTERN

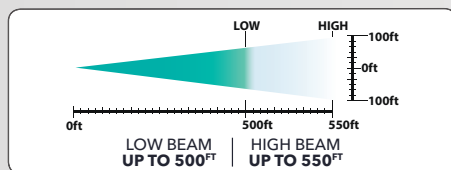

**DOT COMPLIANT**

**LOW BEAM 1890 LUMENS**

**HIGH BEAM 2600 LUMENS**

### WIRING

H4 CONNECTOR  
(3 Wires with Extra Red Wire  
For Halo Function)

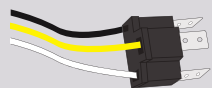

Plug & Play

## 5" X 7" LED REFLECTOR COMBINATION HIGH & LOW BEAM



CHROME  
**TLED-H74** High & Low Beam

### TECHNICAL SPECIFICATIONS

LED POWER	Low: 6.5 Watts High: 13 Watts
RAW LUMENS	Low: 900 Lumens High: 2000 Lumens
EFFECTIVE LUMENS	Low: 620 Lumens High: 900 Lumens
BEAM PATTERN	Combination High & Low
DIODES	3 Diodes
OPERATING VOLTAGE	9-24 Volts (DRL Compatible)
CURRENT DRAW	Low: 0.5 Amps @ 12.8 Volts High: 1.1 Amps @ 12.8 Volts
COLOR TEMPERATURE	6800 Kelvin
HOUSING MATERIAL	Aluminum Die Cast
LENS MATERIAL	Polycarbonate
WATERPROOF RATING	IP67 Rating
COMPLIANCE	DOT SAE   FMVSS-108   CMVSS-108
WARRANTY	5 Years

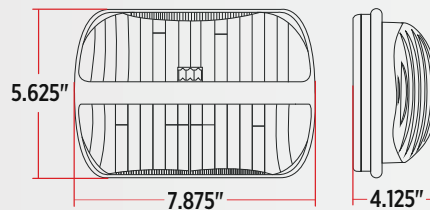

### RETROFIT

- 6052
- 6053
- H6054
- HD6054
- HP6054

### BEAM PATTERN

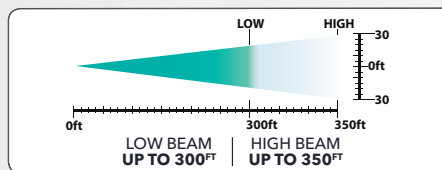

**DOT COMPLIANT**

**LOW BEAM 900 LUMENS**

**HIGH BEAM 2000 LUMENS**

### WIRING

H4 CONNECTOR  
(3 Wires)

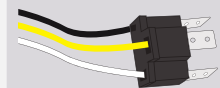

Plug & Play

**WARNING:** Cancer and Reproductive Harm - [www.p65warnings.ca.gov](http://www.p65warnings.ca.gov)

# 5" X 7" OFF ROAD LED COMBINATION HIGH & LOW BEAM

**OFF ROAD**



CHROME  
**TLED-H52** High & Low Beam

### TECHNICAL SPECIFICATIONS

LED POWER	Low: 21 Watts High: 39 Watts
RAW LUMENS	Low: 2100 Lumens High: 3900 Lumens
EFFECTIVE LUMENS	Low: 1000 Lumens High: 1900 Lumens
BEAM PATTERN	Combination High & Low
DIODES	13 Diodes
OPERATING VOLTAGE	9-32 Volts
CURRENT DRAW	Low: 1.23 Amps @ 12 Volts High: 2.28 Amps @ 12 Volts
COLOR TEMPERATURE	6000 Kelvin
HOUSING MATERIAL	Aluminum Die Cast
LENS MATERIAL	Polycarbonate
WATERPROOF RATING	IP67 Rating
COMPLIANCE	Off Road Use Only
WARRANTY	1 Year

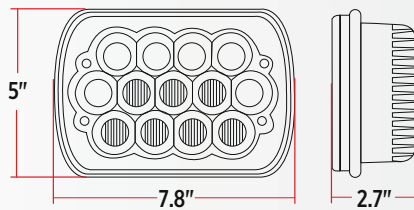

### RETROFIT

- 6052
- 6053
- H6054
- HD6054
- HP6054

### BEAM PATTERN

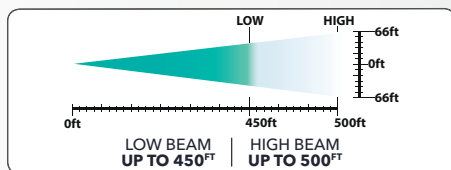

**OFF ROAD**  
USE ONLY

LOW BEAM  
**2100**  
LUMENS

HIGH BEAM  
**3900**  
LUMENS

### WIRING

H4 CONNECTOR  
(3 Wires)

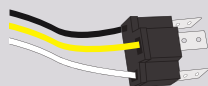

Plug & Play

**WARNING:** Cancer and Reproductive Harm - [www.p65warnings.ca.gov](http://www.p65warnings.ca.gov)

# HEADLIGHTS

## 7" LED PROJECTOR WITH HALO - COMBINATION HIGH & LOW BEAM



CHROME **TLED-H3** High & Low Beam    BLACK **TLED-H70** High & Low Beam

### TECHNICAL SPECIFICATIONS

LED POWER	Low: 9 Watts High: 20 Watts
RAW LUMENS	Low: 1890 Lumens High: 3000 Lumens
EFFECTIVE LUMENS	Low: 700 Lumens High: 800 Lumens
BEAM PATTERN	Combination High & Low
DIODES	9 Diodes
OPERATING VOLTAGE	9-24 Volts (DRL Compatible)
CURRENT DRAW	Low: 0.7 Amps @ 12.8 Volts High: 1.55 Amps @ 12.8 Volts
COLOR TEMPERATURE	6800 Kelvin
HOUSING MATERIAL	Aluminum Die Cast
LENS MATERIAL	Polycarbonate
WATERPROOF RATING	IP67 Rating
COMPLIANCE	DOT SAE   FMVSS-108   CMVSS-108
WARRANTY	7 Years

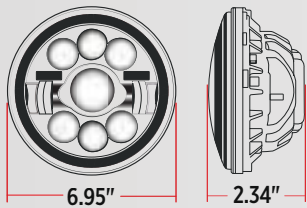

### RETROFIT

- 6014
- 6015
- 6016
- H6024
- PAR56

### BEAM PATTERN

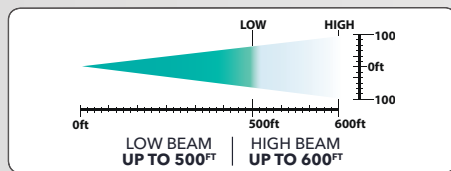

**DOT COMPLIANT**    **LOW BEAM 1890 LUMENS**    **HIGH BEAM 3000 LUMENS**

### WIRING

H4 CONNECTOR  
(3 Wires with Extra Red Wire  
For Halo Function)

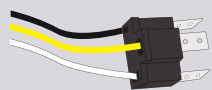

Plug & Play

## 7" LED REFLECTOR COMBINATION HIGH & LOW BEAM



CHROME **TLED-H77** High & Low Beam

### TECHNICAL SPECIFICATIONS

LED POWER	Low: 10 Watts High: 16 Watts
RAW LUMENS	Low: 2700 Lumens High: 2700 Lumens
EFFECTIVE LUMENS	Low: 750 Lumens High: 900 Lumens
BEAM PATTERN	Combination High & Low
DIODES	4 Diodes
OPERATING VOLTAGE	9-24 Volts (DRL Compatible)
CURRENT DRAW	1 Amp @ 12.8 Volts
COLOR TEMPERATURE	6000 Kelvin
HOUSING MATERIAL	Aluminum Alloy
LENS MATERIAL	Polycarbonate
WATERPROOF RATING	IP67 Rating
COMPLIANCE	DOT SAE   FMVSS-108   CMVSS-108
WARRANTY	5 Years

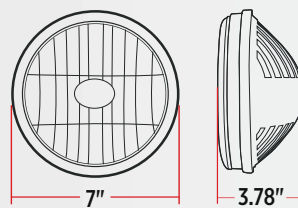

### RETROFIT

- 6014
- 6015
- 6016
- H6024
- PAR56

### BEAM PATTERN

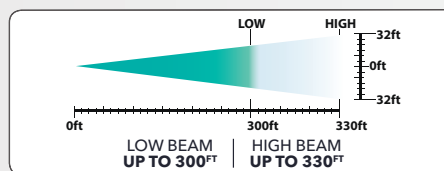

**DOT COMPLIANT**    **LOW BEAM 2700 LUMENS**    **HIGH BEAM 2700 LUMENS**

### WIRING

H4 CONNECTOR  
(3 Wires)



Plug & Play

**WARNING:** Cancer and Reproductive Harm - [www.p65warnings.ca.gov](http://www.p65warnings.ca.gov)



# 7" OFF ROAD LED

WITH HALO - COMBINATION HIGH & LOW BEAM

**OFF ROAD**



CHROME  
**TLED-H51** High & Low Beam

**TECHNICAL SPECIFICATIONS**

LED POWER	Low: 30 Watts High: 60 Watts
RAW LUMENS	Low: 3000 Lumens High: 6000 Lumens
EFFECTIVE LUMENS	Low: 1470 Lumens High: 3000 Lumens
BEAM PATTERN	Combination High & Low
DIODES	12 Diodes
OPERATING VOLTAGE	9-32 Volts
CURRENT DRAW	Low: 1.75 Amps @ 12 Volts High: 3.5 Amps @ 12 Volts
COLOR TEMPERATURE	6000 Kelvin
HOUSING MATERIAL	Aluminum Die Cast
LENS MATERIAL	Polycarbonate
WATERPROOF RATING	IP67 Rating
COMPLIANCE	Off Road Use Only
WARRANTY	1 Year

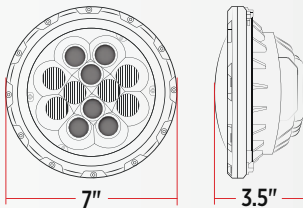

**RETROFIT**

- 6014
- 6015
- 6016
- H6024
- PAR56

**BEAM PATTERN**

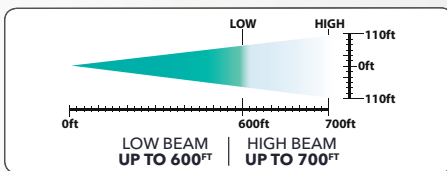

**OFF ROAD**  
USE ONLY

LOW BEAM  
**3000**  
LUMENS

HIGH BEAM  
**6000**  
LUMENS

**WIRING**

H4 CONNECTOR  
(3 Wires with Extra Red Wire  
For Halo Function)

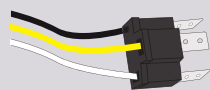

Plug & Play

**WARNING:** Cancer and Reproductive Harm - [www.p65warnings.ca.gov](http://www.p65warnings.ca.gov)



# RADIANT

WORK LAMP SERIES

**FIRST EVER WORK LAMPS WITH SIDE LIGHT OUTPUT**

**360°  
SIDE  
LIGHT OUTPUT**

Introducing the best-selling Radiant Series of LED Work Lamps from Trux. This groundbreaking lineup features 360° of additional diodes around the circumference of the Work Lamp to offer both incredibly bright forward facing **SPOT** Beam AND side facing **FLOOD** Beam.



**TLED-U103**

**4.5" LED WORK LAMP**  
WITH 360° SIDE LIGHT OUTPUT

**TLED-U120**

**4.25" LED WORK LAMP**  
WITH 360° SIDE LIGHT OUTPUT

**PATENTED  
DESIGN**

**HEADLIGHT COMPARISON**  
**NOT JUST YOUR LIGHT OUTPUT**



**TLED-U120**  
Radiant LED Work Lamp

**OEM HALOGEN**  
Work Lamp



**TLED-U120**  
Radiant LED Work Lamp

**LEADING COMPETITOR**  
LED Work Lamp

These first ever COMBINATION LED Work Lamps produce up to 4000 lumens that provide up to 50% more illumination than a standard work light alone. This cutting-edge combination allows operators to enjoy the benefits of multiple applications all in one light.

# WHAT IS RADIANT?

The 'Radiant Series' Work Lamps are designed with diodes placed on the circumference of the Work Lamp with specially designed reflector cups that projects the light out the sides of the work lamp.

SIDE LIGHT OUTPUT  
FRONT VIEW



360° DIODES  
SIDE VIEW

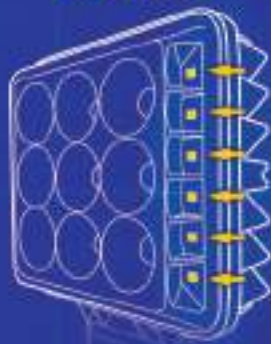

## PERFECT FOR A WIDE RANGE OF APPLICATIONS



AGRICULTURAL



WRECKERS



SERVICE VEHICLES



DELIVERY VEHICLES

## 4.25" SQUARE COMBINATION SPOT & FLOOD BEAM

TOP  
SELLER



COMBINATION SPOT & FLOOD BEAM  
**TLED-U120**

[ PATENT PENDING ]

### TECHNICAL SPECIFICATIONS

RAW LUMENS	4000 Lumens
EFFECTIVE LUMENS	2360 Lumens
BEAM PATTERN	Combination Spot & Flood
DIODES	9 Front   24 Side Diodes
OPERATING VOLTAGE	10-30 Volts
LED POWER	40 Watts
CURRENT DRAW	2.25 Amps @ 12 Volts
COLOR TEMPERATURE	6500 Kelvin
HOUSING MATERIAL	Aluminum Die Cast
BRACKET MATERIAL	Stainless Steel
LENS MATERIAL	Polycarbonate
WATERPROOF RATING	IP67 Rating
SOLD	Individually
WARRANTY	3 Years

### BEAM PATTERN

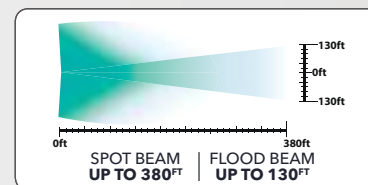

### FUNCTION

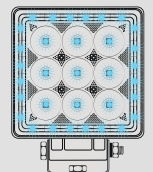

9 Front Diodes  
24 Side Diodes

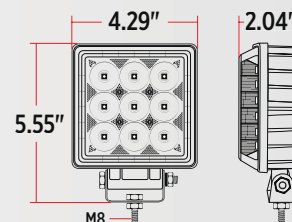

### WIRING

2 WIRE CONNECTION



Connect the negative and positive work lamp wires to the corresponding negative and positive wires from the truck's wiring harness.

**4000**  
LUMENS

**SPOT &  
FLOOD**  
BEAM

⚠ WARNING: Cancer and Reproductive Harm - [www.p65warnings.ca.gov](http://www.p65warnings.ca.gov)

# DOUBLE FACE LED WORK LAMP



**WITH 270° SIDE LIGHT OUTPUT**

Now brighter than ever are Trux Radiant Double Face Work Lamps, a game changer to the industry. Designed with side radial LEDs and two spot functions on both faces of the light to create an intense brilliant forward and back lighting. This compact work light brings twice the amount of brightness to your work area without taking much space on your vehicle.



**TLED-U116**



**FRONT**



**SIDE**

The 'Double Face' LED Work Lamps are designed with diodes placed on the front and back as well as the circumference of the Work Lamp with specially designed reflector cups that projects the light out the sides of the work lamp.

## RADIANT SERIES

### DOUBLE FACE COMBINATION SPOT & FLOOD BEAM

**NEW**



COMBINATION SPOT & FLOOD BEAM  
**TLED-U116**

[ PATENT PENDING ]

#### TECHNICAL SPECIFICATIONS

RAW LUMENS	2200 Lumens
EFFECTIVE LUMENS	1700 Lumens
BEAM PATTERN	Combination Spot & Flood
DIODES	6 Front   14 Side Diodes (Per Face)
OPERATING VOLTAGE	12-24 Volts
LED POWER	20 Watts
CURRENT DRAW	2.27 Amps @ 12 Volts
COLOR TEMPERATURE	6500 Kelvin
HOUSING MATERIAL	ADC12
BRACKET MATERIAL	Stainless Steel
LENS MATERIAL	Polycarbonate
WATERPROOF RATING	IP67 Rating
SOLD	Individually
WARRANTY	3 Years

#### BEAM PATTERN

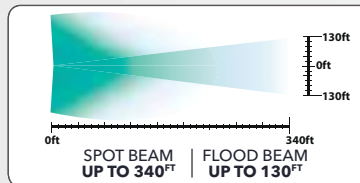

#### FUNCTION

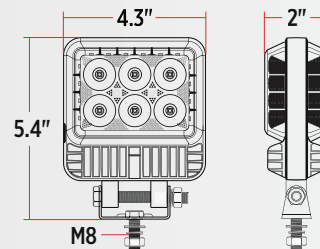
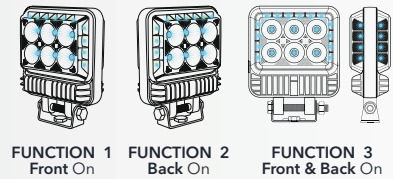

#### WIRING

3 WIRE CONNECTION & 2 POWER SWITCHES

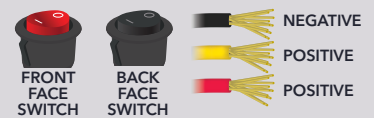

Refer to the Installation Instructions in the packaging for the wiring diagram.

**2200**  
LUMENS  
EACH SIDE

**SPOT & FLOOD**  
BEAM

**DOUBLE**  
FACE  
LIGHTING

**WARNING:** Cancer and Reproductive Harm - [www.p65warnings.ca.gov](http://www.p65warnings.ca.gov)

## 4.5" ROUND COMBINATION SPOT & FLOOD BEAM

**TOP  
SELLER**



COMBINATION SPOT & FLOOD BEAM

### TLED-U103

#### TECHNICAL SPECIFICATIONS

RAW LUMENS	3000 Lumens
EFFECTIVE LUMENS	1800 Lumens
BEAM PATTERN	Combination Spot & Flood
DIODES	6 Front   8 Side Diodes
OPERATING VOLTAGE	12-24 Volts
LED POWER	30 Watts
CURRENT DRAW	2.5 Amps @ 12 Volts
COLOR TEMPERATURE	6500 Kelvin
HOUSING MATERIAL	ADC12
BRACKET MATERIAL	Stainless Steel
LENS MATERIAL	Polycarbonate
WATERPROOF RATING	IP67 Rating
SOLD	Individually
WARRANTY	3 Years

#### BEAM PATTERN

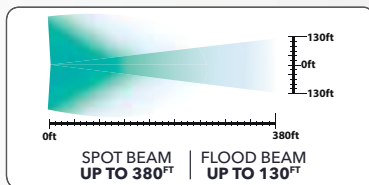

#### FUNCTION

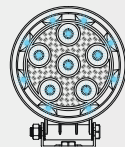

6 Front Diodes  
8 Side Diodes

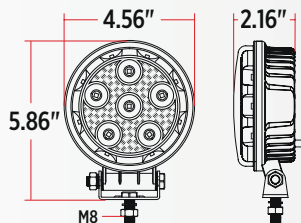

#### WIRING

##### 2 WIRE CONNECTION



Connect the negative and positive work lamp wires to the corresponding negative and positive wires from the truck's wiring harness.

**3000  
LUMENS**

**SPOT &  
FLOOD  
BEAM**

## 4.5" ROUND (PAIR) COMBINATION SPOT & FLOOD BEAM

**TOP  
SELLER**



COMBINATION SPOT & FLOOD BEAM

### TLED-U102

#### TECHNICAL SPECIFICATIONS

RAW LUMENS	4300 Lumens (Each)
EFFECTIVE LUMENS	1920 Lumens (Each)
BEAM PATTERN	Combination Spot & Flood
DIODES	6 Front   3 Side Diodes (Each)
OPERATING VOLTAGE	12-24 Volts
LED POWER	32 Watts (Each)
CURRENT DRAW	2.67 Amps @ 12 Volts
COLOR TEMPERATURE	6500 Kelvin
HOUSING MATERIAL	ADC12
BRACKET MATERIAL	Stainless Steel
LENS MATERIAL	Polycarbonate
WATERPROOF RATING	IP67 Rating
SOLD	As a Pair
WARRANTY	3 Years

#### BEAM PATTERN

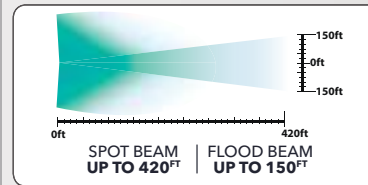

#### FUNCTION

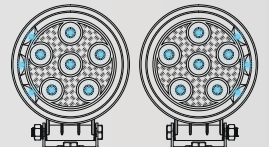

6 Front Diodes (Each)  
3 Side Diodes (Each)

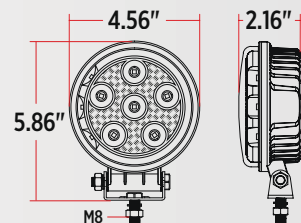

#### WIRING

##### 2 WIRE CONNECTION



Connect the negative and positive work lamp wires to the corresponding negative and positive wires from the truck's wiring harness.

**4300  
LUMENS EACH**

**SPOT &  
FLOOD  
BEAM**

**SOLD IN  
PAIRS**

# SPOT LED WORK LAMP WITH STROBE



**360°**

## STROBE OUTPUT

Perfect for warning are Trux latest multi-functional LED Work Lamps. These LED Work Lamps have you covered from strobe warning to spot function, where you will be able to do your work and not realize the time of day. In line of sight, these cautionary LEDs allows you to see and be seen at a flick of a switch.

## PERFECT FOR A WIDE RANGE OF APPLICATIONS



AGRICULTURAL



WRECKERS



SERVICE VEHICLES



DELIVERY VEHICLES

# STROBE SERIES

## 4.25" SQUARE SPOT BEAM WITH AMBER STROBE

**NEW**



SPOT BEAM WITH AMBER STROBE

### TLED-U118

#### TECHNICAL SPECIFICATIONS

RAW LUMENS	3500 Lumens
EFFECTIVE LUMENS	2500 Lumens
BEAM PATTERN	Spot Beam
DIODES	9 Front   24 Side Diodes
OPERATING VOLTAGE	12-24 Volts
LED POWER	40 Watts
CURRENT DRAW	2.5 Amps @ 12 Volts
COLOR TEMPERATURE	6500 Kelvin
HOUSING MATERIAL	Aluminum Die Cast
BRACKET MATERIAL	Stainless Steel
LENS MATERIAL	Polycarbonate
WATERPROOF RATING	IP67 Rating
SOLD	Individually
WARRANTY	3 Years

#### BEAM PATTERN

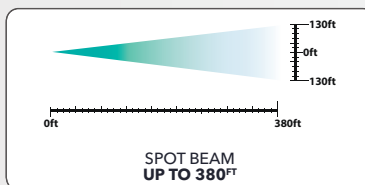

#### FUNCTIONS

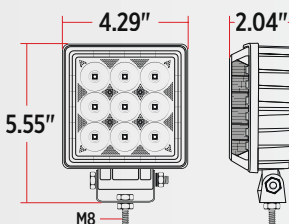
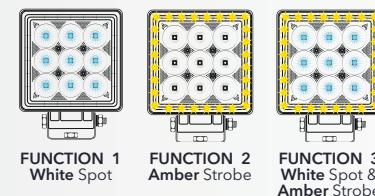

#### WIRING

3 WIRE CONNECTION & 2 POWER SWITCHES



Refer to the Installation Instructions in the packaging for the wiring diagram.

**2500**  
LUMENS

**SPOT**  
BEAM

**STROBE**  
FUNCTION

**2X**  
FUNCTIONS  
IN ONE LIGHT

**WARNING:** Cancer and Reproductive Harm - [www.p65warnings.ca.gov](http://www.p65warnings.ca.gov)

## 4.5" ROUND SPOT BEAM WITH AMBER STROBE

**NEW**



SPOT BEAM WITH AMBER STROBE  
**TLED-U114**

### TECHNICAL SPECIFICATIONS

RAW LUMENS	1800 Lumens
EFFECTIVE LUMENS	1300 Lumens
BEAM PATTERN	Spot Beam
DIODES	5 White Diodes   20 Amber Diodes
OPERATING VOLTAGE	9-30 Volts
LED POWER	25 Watts
CURRENT DRAW	2 Amps @ 12V
COLOR TEMPERATURE	White: 6000 Kelvin Amber: 590 nm
HOUSING MATERIAL	Aluminum Die Cast
BRACKET MATERIAL	Stainless Steel
LENS MATERIAL	Polycarbonate
WATERPROOF RATING	IP67 Rating
SOLD	Individually
WARRANTY	3 Years

### BEAM PATTERN

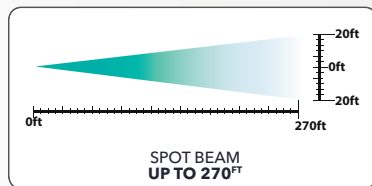

### FUNCTIONS

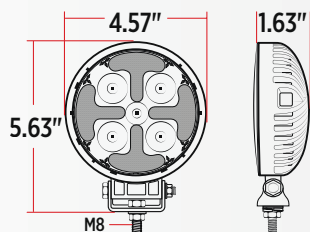
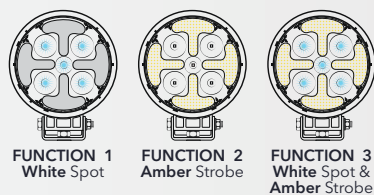

### WIRING

3 WIRE CONNECTION & 2 POWER SWITCHES

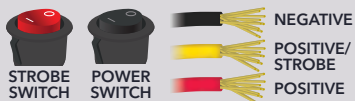

Refer to the Installation Instructions in the packaging for the wiring diagram.

**1800**  
LUMENS

**SPOT**  
BEAM

**STROBE**  
FUNCTION

**2X**  
FUNCTIONS  
IN ONE LIGHT

## 7" HALF MOON FLOOD BEAM WITH AMBER STROBE



**FUNCTION 1**  
White Flood Beam

**FUNCTION 2**  
Amber Strobe

FLOOD BEAM WITH AMBER STROBE  
**TLED-U112** Surface Mount

### TECHNICAL SPECIFICATIONS

RAW LUMENS	White: 800 Lumens Strobe: 750 Lumens
EFFECTIVE LUMENS	White: 780 Lumens Strobe: 700 Lumens
BEAM PATTERN	Flood Beam
DIODES	6 White Diodes   6 Amber Diodes
OPERATING VOLTAGE	12-24 Volts
LED POWER	8 Watts
CURRENT DRAW	0.69 Amps @ 12 Volts
COLOR TEMPERATURE	White: 6500 Kelvin Amber: 1800 Kelvin
HOUSING MATERIAL	Aluminum Die Cast
LENS MATERIAL	Polycarbonate
WATERPROOF RATING	IP65 Rating
SOLD	Individually
WARRANTY	3 Years

### BEAM PATTERN

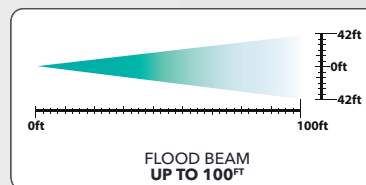

### FUNCTIONS

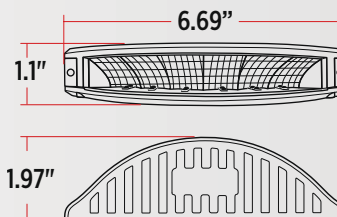

### WIRING

3 WIRE CONNECTION & POWER SWITCH



Refer to the Installation Instructions in the packaging for the wiring diagram.

**800**  
LUMENS

**FLOOD**  
BEAM

**STROBE**  
FUNCTION

**2X**  
FUNCTIONS  
IN ONE LIGHT

**WARNING:** Cancer and Reproductive Harm - [www.p65warnings.ca.gov](http://www.p65warnings.ca.gov)

# STROBE SERIES

## 6" RECTANGLE SPOT BEAM WITH STROBE

**TOP  
SELLER**



SPOT BEAM WITH AMBER STROBE

### TLED-W4

#### TECHNICAL SPECIFICATIONS

RAW LUMENS	1400 Lumens
EFFECTIVE LUMENS	900 Lumens
BEAM PATTERN	Spot Beam
DIODES	20 Diodes
OPERATING VOLTAGE	10-30 Volts
LED POWER	18 Watts
CURRENT DRAW	1.05 Amps @ 12 Volts
COLOR TEMPERATURE	6000 Kelvin
HOUSING MATERIAL	Aluminum Die Cast
BRACKET MATERIAL	Stainless Steel
LENS MATERIAL	Polycarbonate
WATERPROOF RATING	IP67 Rating
SOLD	Sold Individually
WARRANTY	3 Years

#### BEAM PATTERN

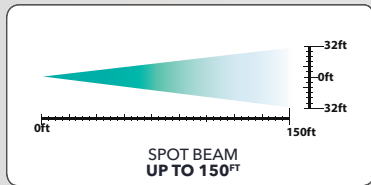

#### FUNCTIONS

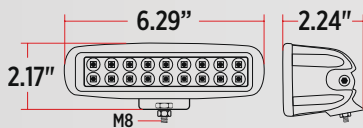
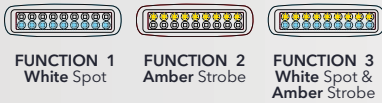

#### WIRING

3 WIRE CONNECTION & 2 POWER SWITCHES



Refer to the Installation Instructions in the packaging for the wiring diagram.

**1400**  
LUMENS

**SPOT**  
BEAM

**STROBE**  
FUNCTION

**2X**  
FUNCTIONS  
IN ONE LIGHT

SPOT BEAM WITH RED STROBE

### TLED-W3

#### TECHNICAL SPECIFICATIONS

RAW LUMENS	1400 Lumens
EFFECTIVE LUMENS	900 Lumens
BEAM PATTERN	Spot Beam
DIODES	20 Diodes
OPERATING VOLTAGE	10-30 Volts
LED POWER	18 Watts
CURRENT DRAW	1.05 Amps @ 12 Volts
COLOR TEMPERATURE	6000 Kelvin
HOUSING MATERIAL	Aluminum Die Cast
BRACKET MATERIAL	Stainless Steel
LENS MATERIAL	Polycarbonate
WATERPROOF RATING	IP67 Rating
SOLD	Sold Individually
WARRANTY	3 Years

#### BEAM PATTERN

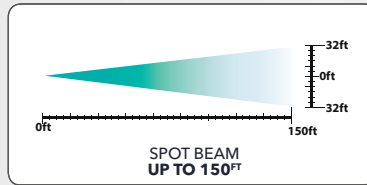

#### FUNCTIONS

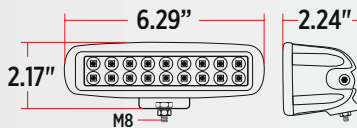

#### WIRING

3 WIRE CONNECTION & 2 POWER SWITCHES



Refer to the Installation Instructions in the packaging for the wiring diagram.

**1400**  
LUMENS

**SPOT**  
BEAM

**STROBE**  
FUNCTION

**2X**  
FUNCTIONS  
IN ONE LIGHT

WARNING: Cancer and Reproductive Harm - [www.p65warnings.ca.gov](http://www.p65warnings.ca.gov)



# 4" CUBE

## SPOT BEAM WITH SIDE STROBE

**TOP  
SELLER**



SPOT BEAM WITH AMBER STROBE

### TLED-U106

#### TECHNICAL SPECIFICATIONS

RAW LUMENS	1800 Lumens (Each)
EFFECTIVE LUMENS	1500 Lumens (Each)
BEAM PATTERN	Spot Beam
DIODES	12 Front Diodes   7 Side Diodes
OPERATING VOLTAGE	9-30 Volts
LED POWER	18 Watts
CURRENT DRAW	1.2 Amps @ 12 Volts (Each)
COLOR TEMPERATURE	6000 Kelvin
HOUSING MATERIAL	Aluminum Die Cast
BRACKET MATERIAL	Stainless Steel
LENS MATERIAL	Polycarbonate
WATERPROOF RATING	IP67 Rating
SOLD	As a Pair
WARRANTY	3 Years

#### BEAM PATTERN

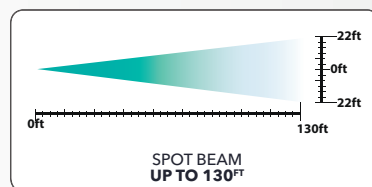

#### FUNCTIONS

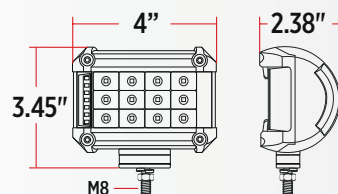
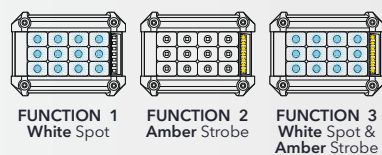

#### WIRING

3 WIRE CONNECTION & 2 POWER SWITCHES



Refer to the Installation Instructions in the packaging for the wiring diagram.

**1800**  
LUMENS EACH

**SPOT**  
BEAM

**58 FPM**  
STROBE

**SOLD IN**  
**PAIRS**



SPOT BEAM WITH RED STROBE

### TLED-U107

#### TECHNICAL SPECIFICATIONS

RAW LUMENS	1800 Lumens (Each)
EFFECTIVE LUMENS	1500 Lumens (Each)
BEAM PATTERN	Spot Beam
DIODES	12 Front Diodes   7 Side Diodes
OPERATING VOLTAGE	9-30 Volts
LED POWER	18 Watts
CURRENT DRAW	1.2 Amps @ 12 Volts (Each)
COLOR TEMPERATURE	6000 Kelvin
HOUSING MATERIAL	Aluminum Die Cast
BRACKET MATERIAL	Stainless Steel
LENS MATERIAL	Polycarbonate
WATERPROOF RATING	IP67 Rating
SOLD	As a Pair
WARRANTY	3 Years

#### BEAM PATTERN

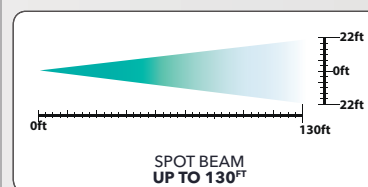

#### FUNCTIONS

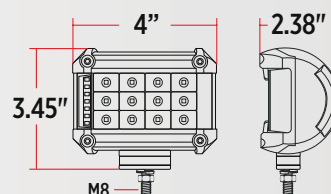
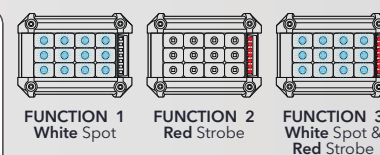

#### WIRING

3 WIRE CONNECTION & 2 POWER SWITCHES



Refer to the Installation Instructions in the packaging for the wiring diagram.

**1800**  
LUMENS EACH

**SPOT**  
BEAM

**58 FPM**  
STROBE

**SOLD IN**  
**PAIRS**

# MINI LED WORK LAMPS

## 2" MINI POS DISPLAY SPOT BEAM - BOX OF 30

**TOP  
SELLER**



**TRX-135**  
BOX CONTAINS  
**30 x TLED-U104**



SPOT BEAM  
**TRX-135** Box of 30

### TECHNICAL SPECIFICATIONS

RAW LUMENS	1500 Lumens
EFFECTIVE LUMENS	900 Lumens
BEAM PATTERN	Spot Beam
DIODES	9 Diodes
OPERATING VOLTAGE	12-24 Volts
LED POWER	18 Watts
CURRENT DRAW	0.87 Amp @ 12 Volts
COLOR TEMPERATURE	6500 Kelvin
HOUSING MATERIAL	Aluminum Die Cast
BRACKET MATERIAL	Stainless Steel
LENS MATERIAL	Polycarbonate
WATERPROOF RATING	IP67 Rating
SOLD	Box of 30
WARRANTY	3 Years

### BEAM PATTERN

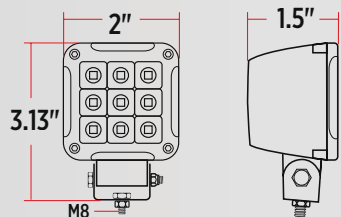
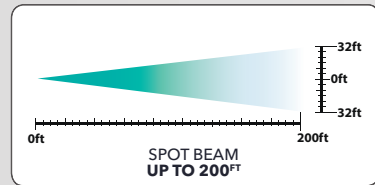

### WIRING

2 WIRE CONNECTION



Connect the negative and positive work lamp wires to the corresponding negative and positive wires from the truck's wiring harness.

**1500**  
LUMENS

**SPOT**  
BEAM

SOLD IN BOX OF  
**30 PCS**

## 6" RECTANGLE POS DISPLAY FLOOD BEAM - BOX OF 21

**NEW**



**TRX-239**  
BOX CONTAINS  
**21 x TLED-U122**



FLOOD BEAM  
**TRX-239** Box of 21

### TECHNICAL SPECIFICATIONS

RAW LUMENS	1100 Lumens
EFFECTIVE LUMENS	750 Lumens
BEAM PATTERN	Flood Beam
DIODES	12 Diodes
OPERATING VOLTAGE	9-30 Volts
LED POWER	18 Watts
CURRENT DRAW	1.5 Amp @ 12 Volts
COLOR TEMPERATURE	6000 Kelvin
HOUSING MATERIAL	Aluminum Die Cast
BRACKET MATERIAL	Stainless Steel
LENS MATERIAL	Polycarbonate
WATERPROOF RATING	IP67 Rating
SOLD	Box of 21
WARRANTY	3 Years

### BEAM PATTERN

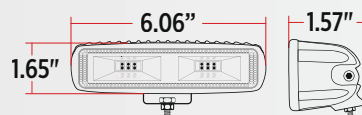
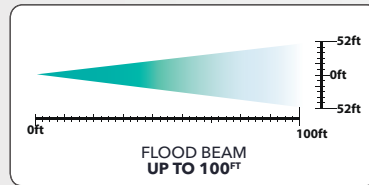

### WIRING

2 WIRE CONNECTION



Connect the negative and positive work lamp wires to the corresponding negative and positive wires from the truck's wiring harness.

**1100**  
LUMENS

**FLOOD**  
BEAM

SOLD IN BOX OF  
**21 PCS**

⚠ WARNING: Cancer and Reproductive Harm - [www.p65warnings.ca.gov](http://www.p65warnings.ca.gov)

## 3" MINI COMBINATION SPOT BEAM & FLOOD BEAM

**TOP  
SELLER**



COMBINATION SPOT & FLOOD BEAM

### TLED-U105

#### TECHNICAL SPECIFICATIONS

RAW LUMENS	900 Lumens
EFFECTIVE LUMENS	500 Lumens
BEAM PATTERN	Combination Spot & Flood Beam
DIODES	2 Diodes Each
OPERATING VOLTAGE	9-32 Volts
LED POWER	9 Watts
CURRENT DRAW	0.65 Amp @ 12 Volts
COLOR TEMPERATURE	6000 Kelvin
HOUSING MATERIAL	Aluminum Die Cast
BRACKET MATERIAL	Stainless Steel
LENS MATERIAL	Polycarbonate
WATERPROOF RATING	IP67 Rating
SOLD	As a Pair
WARRANTY	3 Years

#### BEAM PATTERN

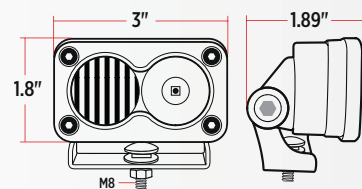
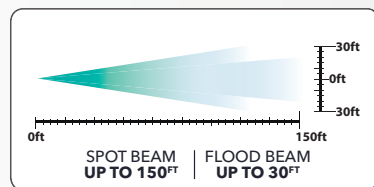

#### WIRING

##### 2 WIRE CONNECTION



Connect the negative and positive work lamp wires to the corresponding negative and positive wires from the truck's wiring harness.

**900  
LUMENS**

**SPOT &  
FLOOD  
BEAM**

**SOLD IN  
PAIRS**

## 2.25" MINI HIGH POWERED SPOT BEAM



SPOT BEAM

### TLED-U6

#### TECHNICAL SPECIFICATIONS

RAW LUMENS	1200 Lumens
EFFECTIVE LUMENS	800 Lumens
BEAM PATTERN	Spot Beam
DIODES	1 Diode
OPERATING VOLTAGE	10-30 Volts
LED POWER	10 Watts
CURRENT DRAW	0.82 Amps @ 12 Volts
COLOR TEMPERATURE	6000 Kelvin
HOUSING MATERIAL	Aluminum Die Cast
BRACKET MATERIAL	Stainless Steel
LENS MATERIAL	Polycarbonate
WATERPROOF RATING	IP67 Rating
SOLD	Individually
WARRANTY	3 Years

#### BEAM PATTERN

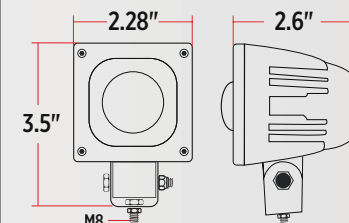
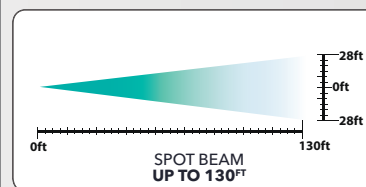

#### WIRING

##### 2 WIRE CONNECTION



Connect the negative and positive work lamp wires to the corresponding negative and positive wires from the truck's wiring harness.

**1200  
LUMENS**

**SPOT  
BEAM**

# LED WORK LAMPS

## 3" MINI STELLAR SERIES SPOT BEAM | FLOOD BEAM



SPOT BEAM  
**TLED-U89**

### TECHNICAL SPECIFICATIONS

RAW LUMENS	1500 Lumens
EFFECTIVE LUMENS	1200 Lumens
BEAM PATTERN	TLED-U89: Spot Beam TLED-U90: Flood Beam
DIODES	5 Diodes
OPERATING VOLTAGE	10-30 Volts
LED POWER	25 Watts
CURRENT DRAW	1.46 Amps @ 12 Volts
COLOR TEMPERATURE	6000 Kelvin
HOUSING MATERIAL	Aluminum Die Cast
BRACKET MATERIAL	Stainless Steel
LENS MATERIAL	Polycarbonate
WATERPROOF RATING	IP67 Rating
SOLD	Individually
WARRANTY	3 Years

### BEAM PATTERN

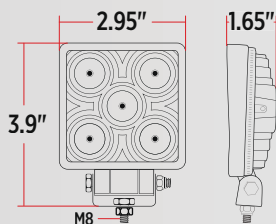
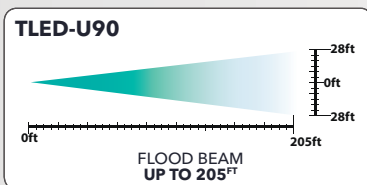
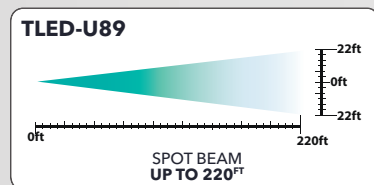

**WIRING**

2 WIRE CONNECTION

Connect the negative and positive work lamp wires to the corresponding negative and positive wires from the truck's wiring harness.

**1500**  
LUMENS

**SPOT BEAM**  
TLED-U89

**FLOOD BEAM**  
TLED-U90

**STELLAR**  
SERIES

## 3" MINI STANDARD SPOT BEAM | FLOOD BEAM



SPOT BEAM  
**TLED-U32**

### TECHNICAL SPECIFICATIONS

RAW LUMENS	1260 Lumens
EFFECTIVE LUMENS	900 Lumens
BEAM PATTERN	TLED-U32: Spot Beam TLED-U33: Flood Beam
DIODES	5 Diodes
OPERATING VOLTAGE	10-30 Volts
LED POWER	15 Watts
CURRENT DRAW	0.86 Amps @ 12 Volts
COLOR TEMPERATURE	6000 Kelvin
HOUSING MATERIAL	Aluminum Die Cast
BRACKET MATERIAL	Stainless Steel
LENS MATERIAL	Polycarbonate
WATERPROOF RATING	IP67 Rating
SOLD	Individually
WARRANTY	3 Years

### BEAM PATTERN

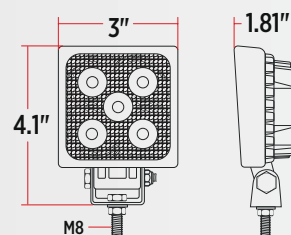
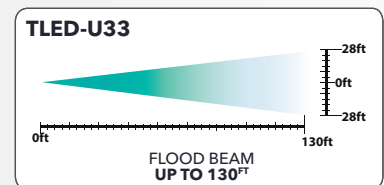
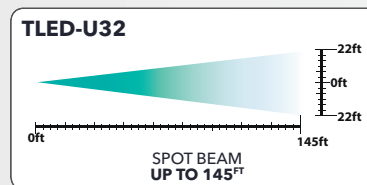

**WIRING**

2 WIRE CONNECTION

Connect the negative and positive work lamp wires to the corresponding negative and positive wires from the truck's wiring harness.

**1260**  
LUMENS

**SPOT BEAM**  
TLED-U32

**FLOOD BEAM**  
TLED-U33

**WARNING: Cancer and Reproductive Harm - [www.p65warnings.ca.gov](http://www.p65warnings.ca.gov)**

# 4" STELLAR SERIES

SPOT BEAM | FLOOD BEAM



SPOT BEAM  
**TLED-U93**

FLOOD BEAM  
**TLED-U94**

**TECHNICAL SPECIFICATIONS**

RAW LUMENS	1600 Lumens
EFFECTIVE LUMENS	1350 Lumens
BEAM PATTERN	TLED-U93: Spot Beam TLED-U94: Flood Beam
DIODES	9 Diodes
OPERATING VOLTAGE	10-30 Volts
LED POWER	27 Watts
CURRENT DRAW	2 Amps @ 12 Volts
COLOR TEMPERATURE	6000 Kelvin
HOUSING MATERIAL	Aluminum Die Cast
BRACKET MATERIAL	Stainless Steel
LENS MATERIAL	Polycarbonate
WATERPROOF RATING	IP67 Rating
SOLD	Individually
WARRANTY	3 Years

**BEAM PATTERN**

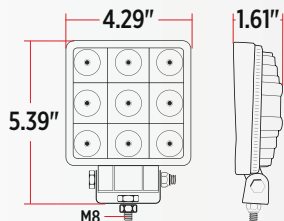
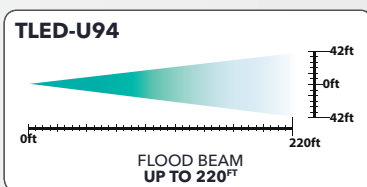
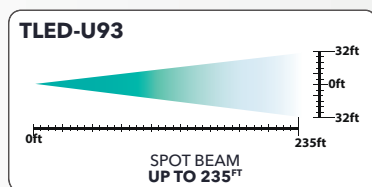

**WIRING**  
2 WIRE CONNECTION

Connect the negative and positive work lamp wires to the corresponding negative and positive wires from the truck's wiring harness.

**1600**  
LUMENS

**SPOT BEAM**  
TLED-U93

**FLOOD BEAM**  
TLED-U94

**STELLAR**  
SERIES

# 4" STANDARD

FLOOD BEAM



FLOOD BEAM  
**TLED-U2**

**TECHNICAL SPECIFICATIONS**

RAW LUMENS	900 Lumens
EFFECTIVE LUMENS	500 Lumens
BEAM PATTERN	Flood Beam
DIODES	5 Diodes
OPERATING VOLTAGE	10-30 Volts
LED POWER	15 Watts
CURRENT DRAW	0.83 Amp @ 12 Volts
COLOR TEMPERATURE	6000 Kelvin
HOUSING MATERIAL	Aluminum Die Cast
BRACKET MATERIAL	Stainless Steel
LENS MATERIAL	Polycarbonate
WATERPROOF RATING	IP67 Rating
SOLD	Individually
WARRANTY	3 Years

**BEAM PATTERN**

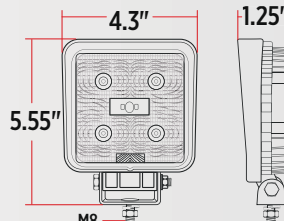
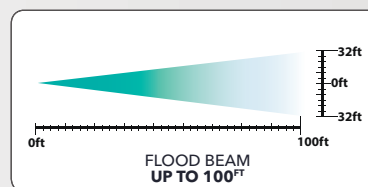

**WIRING**  
2 WIRE CONNECTION

Connect the negative and positive work lamp wires to the corresponding negative and positive wires from the truck's wiring harness.

**900**  
LUMENS

**FLOOD**  
BEAM

# LED WORK LAMPS

## 4.5" HIGH POWERED SPOT BEAM | FLOOD BEAM



SPOT BEAM  
**TLED-U5**

### TECHNICAL SPECIFICATIONS

RAW LUMENS	1600 Lumens
EFFECTIVE LUMENS	900 Lumens
BEAM PATTERN	TLED-U5: Spot Beam TLED-U26: Flood Beam
DIODES	9 Diodes
OPERATING VOLTAGE	10-30 Volts
LED POWER	27 Watts
CURRENT DRAW	1.45 Amps @ 12 Volts
COLOR TEMPERATURE	6000 Kelvin
HOUSING MATERIAL	Aluminum Die Cast
BRACKET MATERIAL	Stainless Steel
LENS MATERIAL	Polycarbonate
WATERPROOF RATING	IP67 Rating
SOLD	Individually
WARRANTY	3 Years

### BEAM PATTERN

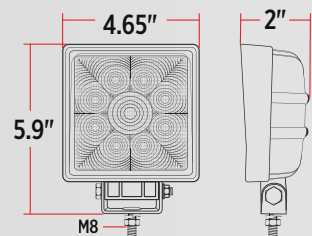
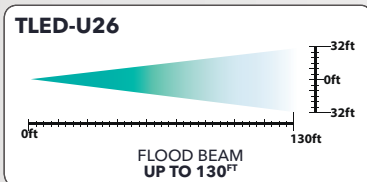
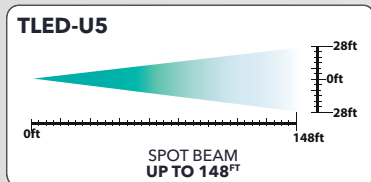

### WIRING

2 WIRE CONNECTION

Connect the negative and positive work lamp wires to the corresponding negative and positive wires from the truck's wiring harness.

**1600**  
LUMENS

**SPOT BEAM**  
TLED-U5

**FLOOD BEAM**  
TLED-U26

## 4.5" STELLAR SERIES HIGH POWERED SPOT BEAM | FLOOD BEAM



SPOT BEAM  
**TLED-U18**

### TECHNICAL SPECIFICATIONS

RAW LUMENS	4000 Lumens
EFFECTIVE LUMENS	2400 Lumens
BEAM PATTERN	TLED-U18: Spot Beam TLED-U27: Flood Beam
DIODES	4 Diodes
OPERATING VOLTAGE	10-30 Volts
LED POWER	40 Watts
CURRENT DRAW	2.34 Amps @ 12 Volts
COLOR TEMPERATURE	6000 Kelvin
HOUSING MATERIAL	Aluminum Die Cast
BRACKET MATERIAL	Stainless Steel
LENS MATERIAL	Polycarbonate
WATERPROOF RATING	IP67 Rating
SOLD	Individually
WARRANTY	3 Years

### BEAM PATTERN

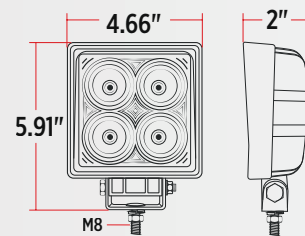
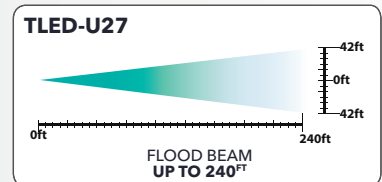
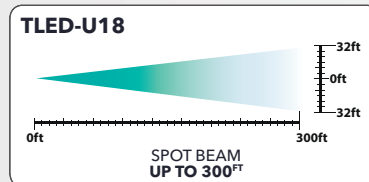

### WIRING

2 WIRE CONNECTION

Connect the negative and positive work lamp wires to the corresponding negative and positive wires from the truck's wiring harness.

**4000**  
LUMENS

**SPOT BEAM**  
TLED-U18

**FLOOD BEAM**  
TLED-U27

**STELLAR**  
SERIES

**WARNING:** Cancer and Reproductive Harm - [www.p65warnings.ca.gov](http://www.p65warnings.ca.gov)

## 3" MINI STELLAR SERIES

SPOT BEAM | FLOOD BEAM



SPOT BEAM  
**TLED-U87**

FLOOD BEAM  
**TLED-U88**

### TECHNICAL SPECIFICATIONS

RAW LUMENS	2000 Lumens
EFFECTIVE LUMENS	1200 Lumens
BEAM PATTERN	TLED-U87: Spot Beam TLED-U88: Flood Beam
DIODES	5 Diodes
OPERATING VOLTAGE	10-30 Volts
LED POWER	25 Watts
CURRENT DRAW	1.25~1.46 Amps @ 12 Volts
COLOR TEMPERATURE	6000 Kelvin
HOUSING MATERIAL	Aluminum Die Cast
BRACKET MATERIAL	Stainless Steel
LENS MATERIAL	Polycarbonate
WATERPROOF RATING	IP67 Rating
SOLD	Individually
WARRANTY	3 Years

### BEAM PATTERN

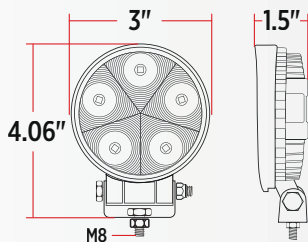
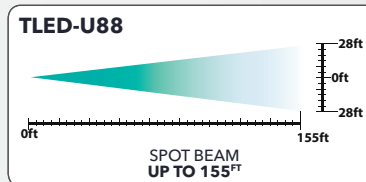
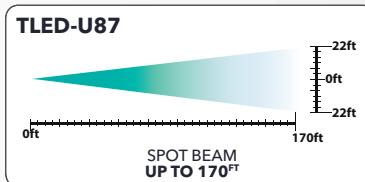

### WIRING

#### 2 WIRE CONNECTION



Connect the negative and positive work lamp wires to the corresponding negative and positive wires from the truck's wiring harness.

**2000**  
LUMENS

**SPOT BEAM**  
TLED-U87

**FLOOD BEAM**  
TLED-U88

**STELLAR**  
SERIES

## 3" MINI

SPOT BEAM | FLOOD BEAM



SPOT BEAM  
**TLED-U34**

FLOOD BEAM  
**TLED-U35**

### TECHNICAL SPECIFICATIONS

RAW LUMENS	1260 Lumens
EFFECTIVE LUMENS	900 Lumens
BEAM PATTERN	TLED-U34: Spot Beam TLED-U35: Flood Beam
DIODES	5 Diodes
OPERATING VOLTAGE	10-30 Volts
LED POWER	15 Watts
CURRENT DRAW	0.69 Amps @ 12 Volts
COLOR TEMPERATURE	6000 Kelvin
HOUSING MATERIAL	Aluminum Die Cast
BRACKET MATERIAL	Stainless Steel
LENS MATERIAL	Polycarbonate
WATERPROOF RATING	IP67 Rating
SOLD	Individually
WARRANTY	3 Years

### BEAM PATTERN

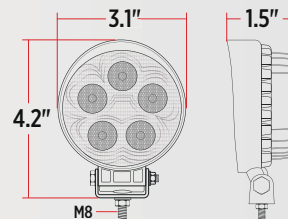
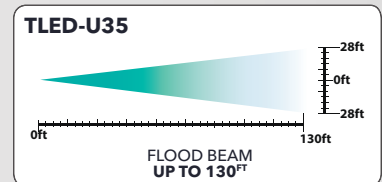
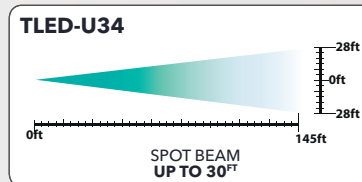

### WIRING

#### 2 WIRE CONNECTION



Connect the negative and positive work lamp wires to the corresponding negative and positive wires from the truck's wiring harness.

**1260**  
LUMENS

**SPOT BEAM**  
TLED-U34

**FLOOD BEAM**  
TLED-U35

# LED WORK LAMPS

## 4.5" STELLAR SERIES FLOOD BEAM



### FLOOD BEAM TLED-U96

#### TECHNICAL SPECIFICATIONS

RAW LUMENS	1600 Lumens
EFFECTIVE LUMENS	1350 Lumens
BEAM PATTERN	Flood Beam
DIODES	9 Diodes
OPERATING VOLTAGE	10-30 Volts
LED POWER	27 Watts
CURRENT DRAW	2 Amps @ 12 Volts
COLOR TEMPERATURE	6000 Kelvin
HOUSING MATERIAL	Aluminum Die Cast
BRACKET MATERIAL	Stainless Steel
LENS MATERIAL	Polycarbonate
WATERPROOF RATING	IP67 Rating
SOLD	Individually
WARRANTY	3 Years

#### BEAM PATTERN

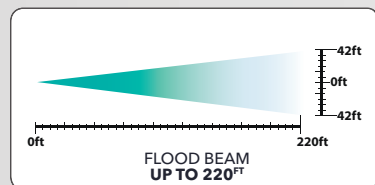

**WIRING**

2 WIRE CONNECTION

Connect the negative and positive work lamp wires to the corresponding negative and positive wires from the truck's wiring harness.

**1600 LUMENS** **FLOOD BEAM**

**STELLAR SERIES**

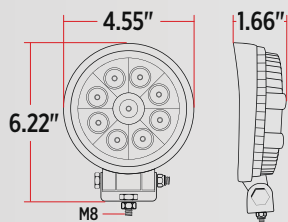

## 4.5" STANDARD FLOOD BEAM



### FLOOD BEAM TLED-U1

#### TECHNICAL SPECIFICATIONS

RAW LUMENS	1000 Lumens
EFFECTIVE LUMENS	600 Lumens
BEAM PATTERN	Flood Beam
DIODES	6 Diodes
OPERATING VOLTAGE	10-30 Volts
LED POWER	18 Watts
CURRENT DRAW	1.01 Amps @ 12 Volts
COLOR TEMPERATURE	6000 Kelvin
HOUSING MATERIAL	Aluminum Die Cast
BRACKET MATERIAL	Stainless Steel
LENS MATERIAL	Polycarbonate
WATERPROOF RATING	IP67 Rating
SOLD	Individually
WARRANTY	3 Years

#### BEAM PATTERN

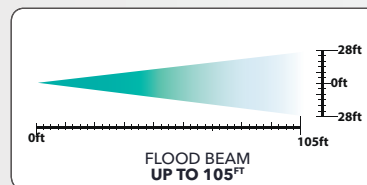

**WIRING**

2 WIRE CONNECTION

Connect the negative and positive work lamp wires to the corresponding negative and positive wires from the truck's wiring harness.

**1000 LUMENS** **FLOOD BEAM**

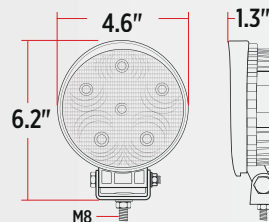

⚠ WARNING: Cancer and Reproductive Harm - [www.p65warnings.ca.gov](http://www.p65warnings.ca.gov)



## 5" HIGH POWERED SPOT BEAM | FLOOD BEAM



SPOT BEAM  
**TLED-U4**



FLOOD BEAM  
**TLED-U25**

### TECHNICAL SPECIFICATIONS

RAW LUMENS	1600 Lumens
EFFECTIVE LUMENS	900 Lumens
BEAM PATTERN	TLED-U4: Spot Beam TLED-U25: Flood Beam
DIODES	9 Diodes
OPERATING VOLTAGE	10-30 Volts
LED POWER	27 Watts
CURRENT DRAW	1.39 Amps @ 12 Volts
COLOR TEMPERATURE	6000 Kelvin
HOUSING MATERIAL	Aluminum Die Cast
BRACKET MATERIAL	Stainless Steel
LENS MATERIAL	Polycarbonate
WATERPROOF RATING	IP67 Rating
SOLD	Individually
WARRANTY	3 Years

### BEAM PATTERN

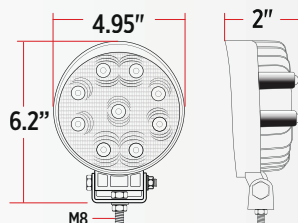
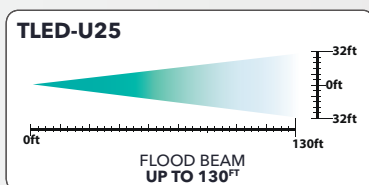
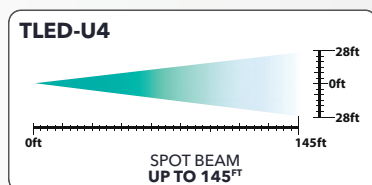

**WIRING**  
2 WIRE CONNECTION

Connect the negative and positive work lamp wires to the corresponding negative and positive wires from the truck's wiring harness.

**1600**  
LUMENS

**SPOT BEAM**  
TLED-U4

**FLOOD BEAM**  
TLED-U25

## 5" STELLAR SERIES HIGH POWERED SPOT BEAM | FLOOD BEAM



SPOT BEAM  
**TLED-U19**



FLOOD BEAM  
**TLED-U28**

### TECHNICAL SPECIFICATIONS

RAW LUMENS	4200 Lumens
EFFECTIVE LUMENS	2400 Lumens
BEAM PATTERN	TLED-U19: Spot Beam TLED-U28: Flood Beam
DIODES	6 Diodes
OPERATING VOLTAGE	10-30 Volts
LED POWER	30 Watts
CURRENT DRAW	2.27 Amps @ 12 Volts
COLOR TEMPERATURE	6000 Kelvin
HOUSING MATERIAL	Aluminum Die Cast
BRACKET MATERIAL	Stainless Steel
LENS MATERIAL	Polycarbonate
WATERPROOF RATING	IP67 Rating
SOLD	Individually
WARRANTY	3 Years

### BEAM PATTERN

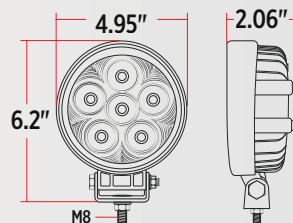
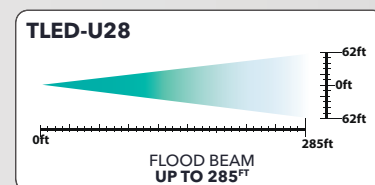
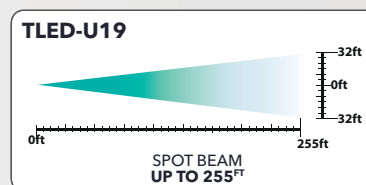

**WIRING**  
2 WIRE CONNECTION

Connect the negative and positive work lamp wires to the corresponding negative and positive wires from the truck's wiring harness.

**4200**  
LUMENS

**SPOT BEAM**  
TLED-U19

**FLOOD BEAM**  
TLED-U28

**STELLAR**  
SERIES

# LED WORK LAMPS

## 6" OVAL HIGH POWERED SPOT BEAM



SPOT BEAM  
**TLED-U8**

### TECHNICAL SPECIFICATIONS

RAW LUMENS	3000 Lumens
EFFECTIVE LUMENS	2700 Lumens
BEAM PATTERN	Spot Beam
DIODES	3 Diodes
OPERATING VOLTAGE	10-30 Volts
LED POWER	30 Watts
CURRENT DRAW	2.24 Amps @ 12 Volts
COLOR TEMPERATURE	6000 Kelvin
HOUSING MATERIAL	Aluminum Die Cast
BRACKET MATERIAL	Stainless Steel
LENS MATERIAL	Polycarbonate
WATERPROOF RATING	IP67 Rating
SOLD	Individually
WARRANTY	3 Years

### BEAM PATTERN

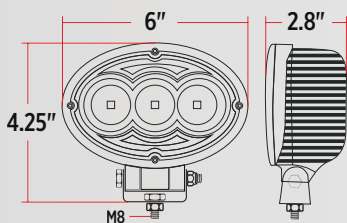
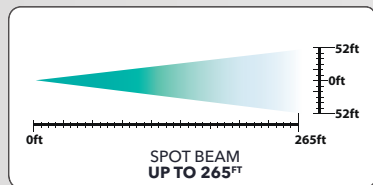

**WIRING**

2 WIRE CONNECTION

Connect the negative and positive work lamp wires to the corresponding negative and positive wires from the truck's wiring harness.

**3000 LUMENS** **SPOT BEAM**

## 6" OVAL SUPER POWERED SPOT BEAM | FLOOD BEAM

**TOP SELLER**



SPOT BEAM  
**TLED-U9**

### TECHNICAL SPECIFICATIONS

RAW LUMENS	6000 Lumens
EFFECTIVE LUMENS	5400 Lumens
BEAM PATTERN	TLED-U9: Spot Beam TLED-U29: Flood Beam
DIODES	6 Diodes
OPERATING VOLTAGE	10-30 Volts
LED POWER	60 Watts
CURRENT DRAW	4.34 Amps @ 12 Volts
COLOR TEMPERATURE	6000 Kelvin
HOUSING MATERIAL	Aluminum Die Cast
BRACKET MATERIAL	Stainless Steel
LENS MATERIAL	Polycarbonate
WATERPROOF RATING	IP67 Rating
SOLD	Individually
WARRANTY	3 Years

### BEAM PATTERN

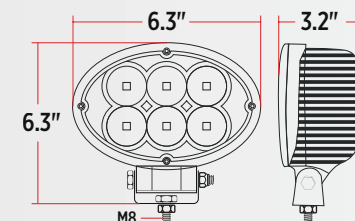
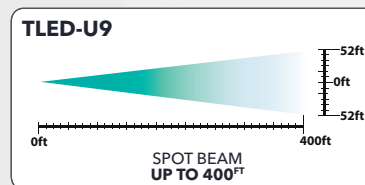

FLOOD BEAM  
**TLED-U29**

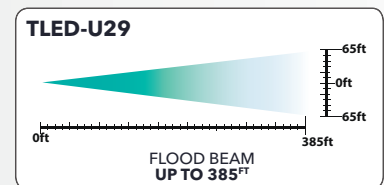

**WIRING**

2 WIRE CONNECTION

Connect the negative and positive work lamp wires to the corresponding negative and positive wires from the truck's wiring harness.

**6000 LUMENS** **SPOT BEAM TLED-U9** **FLOOD BEAM TLED-U29**

**WARNING:** Cancer and Reproductive Harm - [www.p65warnings.ca.gov](http://www.p65warnings.ca.gov)

## 6" RECTANGLE

### SPOT BEAM | FLOOD BEAM



#### SPOT BEAM TLED-U97

##### TECHNICAL SPECIFICATIONS

RAW LUMENS	1600 Lumens
EFFECTIVE LUMENS	1000 Lumens
BEAM PATTERN	Spot Beam
DIODES	6 Diodes
OPERATING VOLTAGE	10-30 Volts
LED POWER	18 Watts
CURRENT DRAW	0.51 Amps @ 12 Volts
COLOR TEMPERATURE	6000 Kelvin
HOUSING MATERIAL	Aluminum Die Cast
LENS MATERIAL	Polycarbonate
WATERPROOF RATING	IP67 Rating
SOLD	Individually
WARRANTY	3 Years

##### BEAM PATTERN

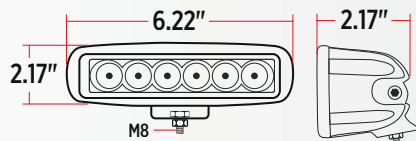
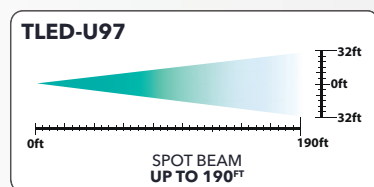

##### WIRING

###### 2 WIRE CONNECTION



Connect the negative and positive work lamp wires to the corresponding negative and positive wires from the truck's wiring harness.

**1600**  
LUMENS

**SPOT**  
BEAM

**STELLAR**  
SERIES



#### FLOOD BEAM TLED-U98

##### TECHNICAL SPECIFICATIONS

RAW LUMENS	1600 Lumens
EFFECTIVE LUMENS	1000 Lumens
BEAM PATTERN	Flood Beam
DIODES	6 Diodes
OPERATING VOLTAGE	10-30 Volts
LED POWER	18 Watts
CURRENT DRAW	1.8 Amps @ 12 Volts
COLOR TEMPERATURE	6000 Kelvin
HOUSING MATERIAL	Aluminum Die Cast
LENS MATERIAL	Polycarbonate
WATERPROOF RATING	IP67 Rating
SOLD	Individually
WARRANTY	3 Years

##### BEAM PATTERN

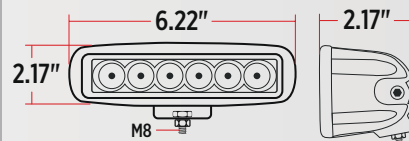
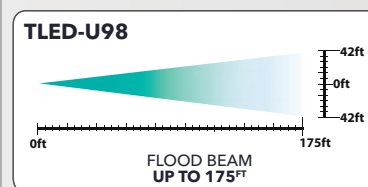

##### WIRING

###### 2 WIRE CONNECTION



Connect the negative and positive work lamp wires to the corresponding negative and positive wires from the truck's wiring harness.

**1600**  
LUMENS

**FLOOD**  
BEAM

**STELLAR**  
SERIES

# LED WORK LAMPS

## 2.5" X 4.5" MINI SUPER POWERED SPOT BEAM



### SPOT BEAM TLED-U10

#### TECHNICAL SPECIFICATIONS

RAW LUMENS	2400 Lumens
EFFECTIVE LUMENS	1600 Lumens
BEAM PATTERN	Spot Beam
DIODES	2 Diodes
OPERATING VOLTAGE	10-30 Volts
LED POWER	24 Watts
CURRENT DRAW	1.85 Amps @ 12 Volts
COLOR TEMPERATURE	6000 Kelvin
HOUSING MATERIAL	Aluminum Die Cast
BRACKET MATERIAL	Stainless Steel
LENS MATERIAL	Polycarbonate
WATERPROOF RATING	IP67 Rating
SOLD	Individually
WARRANTY	3 Years

#### BEAM PATTERN

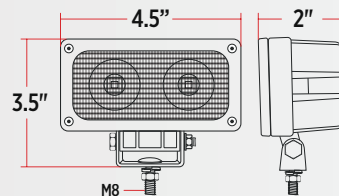
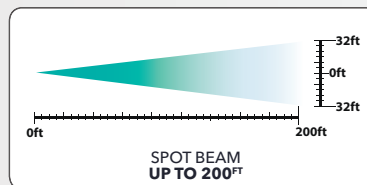

#### WIRING

##### 2 WIRE CONNECTION



Connect the negative and positive work lamp wires to the corresponding negative and positive wires from the truck's wiring harness.

**2400**  
LUMENS

**SPOT**  
BEAM

## 4" X 6" STANDARD SPOT BEAM | FLOOD BEAM



SPOT BEAM  
**TLED-U21**

FLOOD BEAM  
**TLED-U20**

### TECHNICAL SPECIFICATIONS

RAW LUMENS	660 Lumens
EFFECTIVE LUMENS	650 Lumens
BEAM PATTERN	TLED-U21: Spot Beam TLED-U20: Flood Beam
DIODES	6 Diodes
OPERATING VOLTAGE	12 Volts
LED POWER	17.4 Watts
CURRENT DRAW	1.45 Amps @ 12 Volts
COLOR TEMPERATURE	6000 Kelvin
HOUSING MATERIAL	Aluminum Die Cast
BRACKET MATERIAL	Stainless Steel
LENS MATERIAL	Polycarbonate
WATERPROOF RATING	IP67 Rating
SOLD	Individually
WARRANTY	3 Years

### BEAM PATTERN

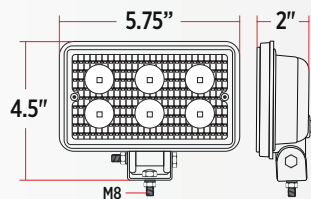
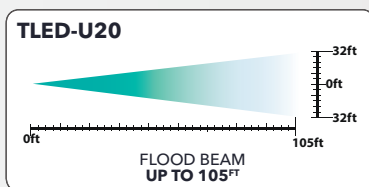
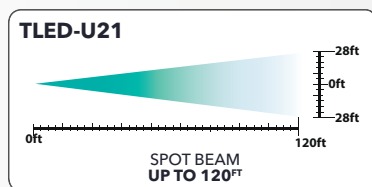

### WIRING

2 WIRE CONNECTION

Connect the negative and positive work lamp wires to the corresponding negative and positive wires from the truck's wiring harness.

**660**  
LUMENS

**SPOT BEAM**  
TLED-U21

**FLOOD BEAM**  
TLED-U20

## 4" X 6" HIGH POWERED SPOT BEAM | FLOOD BEAM

**TOP  
SELLER**



SPOT BEAM  
**TLED-U40**

FLOOD BEAM  
**TLED-U22**

### TECHNICAL SPECIFICATIONS

RAW LUMENS	1080 Lumens
EFFECTIVE LUMENS	970 Lumens
BEAM PATTERN	TLED-U40: Spot Beam TLED-U22: Flood Beam
DIODES	6 Diodes
OPERATING VOLTAGE	12 Volts
LED POWER	22.2 Watts
CURRENT DRAW	1.85 Amps @ 12 Volts
COLOR TEMPERATURE	6000 Kelvin
HOUSING MATERIAL	Aluminum Die Cast
BRACKET MATERIAL	Stainless Steel
LENS MATERIAL	Polycarbonate
WATERPROOF RATING	IP67 Rating
SOLD	Individually
WARRANTY	3 Years

### BEAM PATTERN

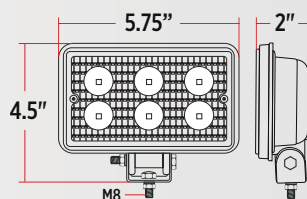
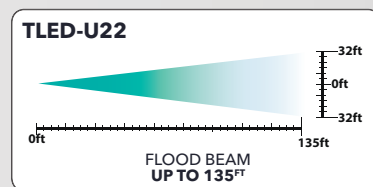
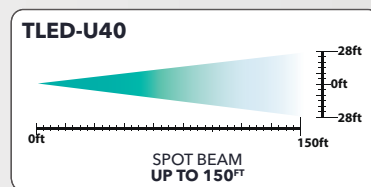

### WIRING

2 WIRE CONNECTION

Connect the negative and positive work lamp wires to the corresponding negative and positive wires from the truck's wiring harness.

**1080**  
LUMENS

**SPOT BEAM**  
TLED-U40

**FLOOD BEAM**  
TLED-U22

# LED WORK LAMPS

## 7" HALF MOON SURFACE MOUNT | FLOOD BEAM

**TOP  
SELLER**



### FLOOD BEAM TLED-U108

#### TECHNICAL SPECIFICATIONS

RAW LUMENS	800 Lumens
EFFECTIVE LUMENS	780 Lumens
BEAM PATTERN	Flood Beam
DIODES	6 Diodes
OPERATING VOLTAGE	12-24 Volts
LED POWER	8 Watts
CURRENT DRAW	0.69 Amps @ 12 Volts
COLOR TEMPERATURE	6500 Kelvin
HOUSING MATERIAL	Aluminum Die Cast
LENS MATERIAL	Polycarbonate
WATERPROOF RATING	IP65 Rating
SOLD	Individually
WARRANTY	3 Years

#### BEAM PATTERN

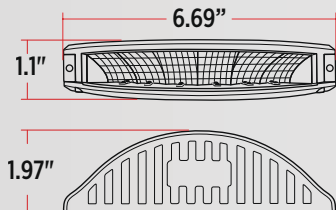
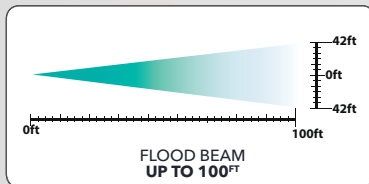

#### WIRING

##### 2 WIRE CONNECTION



Connect the negative and positive work lamp wires to the corresponding negative and positive wires from the truck's wiring harness.

**800**  
LUMENS

**FLOOD**  
BEAM

## SURFACE MOUNT COMBINATION SPOT BEAM & FLOOD BEAM



### COMBINATION SPOT & FLOOD BEAM TLED-U49

#### TECHNICAL SPECIFICATIONS

RAW LUMENS	1600 Lumens
EFFECTIVE LUMENS	1000 Lumens
BEAM PATTERN	Combination Spot & Flood Beam
DIODES	4 Diodes
OPERATING VOLTAGE	10-30 Volts
LED POWER	16 Watts
CURRENT DRAW	0.94 Amps @ 12 Volts
COLOR TEMPERATURE	6000 Kelvin
HOUSING MATERIAL	Aluminum Die Cast
LENS MATERIAL	Polycarbonate
WATERPROOF RATING	IP67 Rating
SOLD	Individually
WARRANTY	3 Years

#### BEAM PATTERN

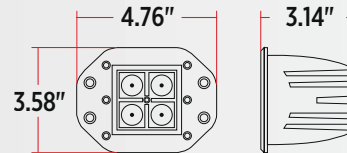
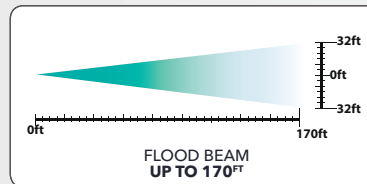

#### WIRING

##### 2 WIRE CONNECTION



Connect the negative and positive work lamp wires to the corresponding negative and positive wires from the truck's wiring harness.

**1600**  
LUMENS

**SPOT &  
FLOOD**  
BEAM

WARNING: Cancer and Reproductive Harm - [www.p65warnings.ca.gov](http://www.p65warnings.ca.gov)

# 4" GROMMET MOUNT FLOOD BEAM



FLOOD BEAM  
**TLED-U16**

**TECHNICAL SPECIFICATIONS**

RAW LUMENS	660 Lumens
EFFECTIVE LUMENS	650 Lumens
BEAM PATTERN	Flood Beam
DIODES	6 Diodes
OPERATING VOLTAGE	12 Volts
LED POWER	10.2 Watts
CURRENT DRAW	0.85 Amps @ 12 Volts
COLOR TEMPERATURE	6000 Kelvin
HOUSING MATERIAL	Aluminum Die Cast
LENS MATERIAL	Polycarbonate
WATERPROOF RATING	IP67 Rating
SOLD	Individually
WARRANTY	3 Years

**BEAM PATTERN**

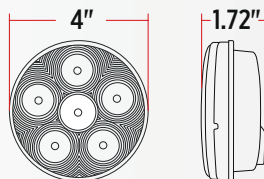
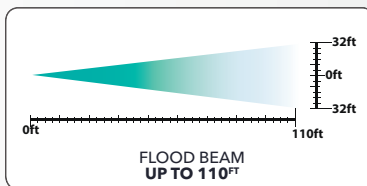

**WIRING**

3 PRONG ADAPTER

Assemble with any Triple 3 Prong Male Wire Harness.

**660**  
LUMENS

**FLOOD**  
BEAM

# OVAL GROMMET MOUNT FLOOD BEAM



FLOOD BEAM  
**TLED-U17**

**TECHNICAL SPECIFICATIONS**

RAW LUMENS	660 Lumens
EFFECTIVE LUMENS	650 Lumens
BEAM PATTERN	Flood Beam
DIODES	6 Diodes
OPERATING VOLTAGE	12 Volts
LED POWER	10.2 Watts
CURRENT DRAW	0.85 Amps @ 12 Volts
COLOR TEMPERATURE	6000 Kelvin
HOUSING MATERIAL	Aluminum Die Cast
LENS MATERIAL	Polycarbonate
WATERPROOF RATING	IP67 Rating
SOLD	Individually
WARRANTY	3 Years

**BEAM PATTERN**

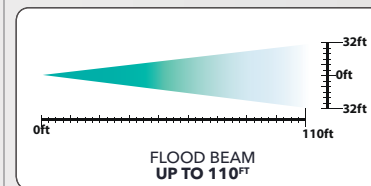

**WIRING**

3 PRONG ADAPTER

Assemble with any Triple 3 Prong Male Wire Harness.

**660**  
LUMENS

**FLOOD**  
BEAM

# LED BEACON LIGHTS

## MEDIUM PROFILE 1" PIPE MOUNT

**NEW**



AMBER SINGLE FLASH PATTERN

### TLED-W1

#### TECHNICAL SPECIFICATIONS

FLASH PATTERN	Single Flash Pattern
RAW LUMENS	380 Lumens
EFFECTIVE LUMENS	110 Lumens
DIODES	3 Diodes
OPERATING VOLTAGE	12-24 Volts
LED POWER	6 Watts
CURRENT DRAW	0.5 Amps @ 12 Volts
COLOR TEMPERATURE	1800 Kelvin
HOUSING MATERIAL	Polycarbonate
LENS MATERIAL	Polycarbonate
WATERPROOF RATING	IP55 Rating
SOLD	Individually
WARRANTY	1 Year

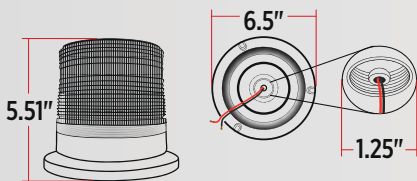

#### WIRING

##### 2 WIRE CONNECTION



Connect the negative and positive work lamp wires to the corresponding negative and positive wires from the truck's wiring harness.

**380**  
LUMENS

**1** FLASH  
PATTERN

**PIPE**  
MOUNT

## DOME VACCUM MAGNETIC MOUNT

**NEW**



AMBER - 3 FLASH PATTERN

### TLED-W2

#### TECHNICAL SPECIFICATIONS

FLASH PATTERN	3 Flash Patterns
RAW LUMENS	960 Lumens
EFFECTIVE LUMENS	470 Lumens
DIODES	12 Diodes
OPERATING VOLTAGE	12-24 Volts
LED POWER	27 Watts
CURRENT DRAW	2 Amps @ 12 Volts
COLOR TEMPERATURE	1800 Kelvin
HOUSING MATERIAL	Polycarbonate
LENS MATERIAL	Polycarbonate
WATERPROOF RATING	IP55 Rating
SOLD	Individually
WARRANTY	1 Year

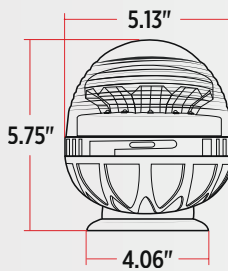

#### WIRING

##### CIGARETTE LIGHTER SOCKET ADAPTER



Connects to any Cigarette Lighter Socket.

**960**  
LUMENS

**3** FLASH  
PATTERNS

**VACCUM**  
MAGNETIC  
MOUNT



## LIGHT BAR PERMANENT MOUNT

**NEW**



TOP VIEW

AMBER - 3 FLASH PATTERN

### TLED-W5

#### TECHNICAL SPECIFICATIONS

FLASH PATTERN	3 Flash Patterns
RAW LUMENS	1440 Lumens
EFFECTIVE LUMENS	700 Lumens
DIODES	18 Diodes
OPERATING VOLTAGE	12-24 Volts
LED POWER	27 Watts
CURRENT DRAW	2.3 Amps @ 12 Volts
COLOR TEMPERATURE	1800 Kelvin
HOUSING MATERIAL	Polycarbonate
LENS MATERIAL	Polycarbonate
WATERPROOF RATING	IP55 Rating
SOLD	Individually
WARRANTY	1 Year

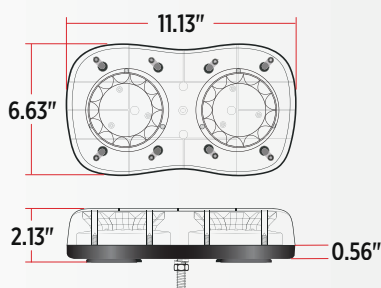

#### WIRING

2 WIRE CONNECTION & SWITCH



Refer to the Installation Instructions in the packaging for the wiring diagram.

**1440**  
LUMENS

**3** FLASH  
PATTERNS

**PERMANENT**  
**MOUNT**

WARNING: Cancer and Reproductive Harm - [www.p65warnings.ca.gov](http://www.p65warnings.ca.gov)

# LED BEACON LIGHTS

## MEDIUM PROFILE

1" PIPE / PERMANENT MOUNT  
SINGLE FLASH PATTERN  
380 LUMENS  
12-24 VOLTS



TLED-W1

## DOME

VACUUM MAGNETIC MOUNT  
3 FLASH PATTERNS  
960 LUMENS  
12-24 VOLTS



TLED-W2

## LIGHT BAR

PERMANENT MOUNT  
3 FLASH PATTERNS  
1440 LUMENS  
12-24 VOLTS

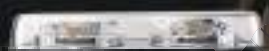

TLED-W5

# CLASS 1 STROBE SERIES

**3 DIODES**  
24 FLASH PATTERNS

**NEW**



3 DIODES  
**TLED-W13A24**

### TECHNICAL SPECIFICATIONS

CLASSIFICATION	SAE J595 Class 1
COMPLIANCE	ECE R65, EMC R10, RoHS
FLASH PATTERNS	24 Flash Patterns
COLOR	Amber
DIODES	3 Diodes
OPERATING VOLTAGE	12-24 Volts
FUNCTIONS	1. Synchronization 2. Alternating Function 3. Last Pattern Recall
HOUSING MATERIAL	Aluminum Die Cast
LENS MATERIAL	Polycarbonate
WATERPROOF RATING	IP65 Rating
SOLD	Individually
WARRANTY	5 Years

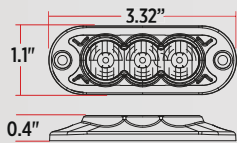

### WIRING

- 4 WIRE CONNECTION
- GROUND
  - PATTERN SELECT
  - POWER
  - SYNCHRONIZATION

Refer to the Installation Instructions in the packaging for the wiring diagram.

**CLASS 1**  
SAE J595

**24**  
FLASH PATTERNS

**L-BRACKET**  
INCLUDED

**3M TAPE**  
INCLUDED

**4 DIODES**  
26 FLASH PATTERNS

**NEW**



4 DIODES  
**TLED-W14A26**

### TECHNICAL SPECIFICATIONS

CLASSIFICATION	SAE J595 Class 1
COMPLIANCE	ECE R65, EMC R10, RoHS
FLASH PATTERNS	26 Flash Patterns
COLOR	Amber
DIODES	4 Diodes
OPERATING VOLTAGE	12-24 Volts
FUNCTIONS	1. Synchronization 2. Alternating Function 3. Last Pattern Recall
HOUSING MATERIAL	Aluminum Die Cast
LENS MATERIAL	Polycarbonate
WATERPROOF RATING	IP65 Rating
SOLD	Individually
WARRANTY	5 Years

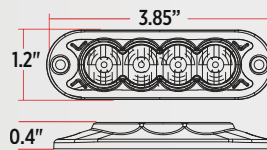

### WIRING

- 4 WIRE CONNECTION
- GROUND
  - PATTERN SELECT
  - POWER
  - SYNCHRONIZATION

Refer to the Installation Instructions in the packaging for the wiring diagram.

**CLASS 1**  
SAE J595

**26**  
FLASH PATTERNS

**L-BRACKET**  
INCLUDED

**3M TAPE**  
INCLUDED

**6 DIODES**  
26 FLASH PATTERNS

**NEW**



6 DIODES  
**TLED-W16A26**

### TECHNICAL SPECIFICATIONS

CLASSIFICATION	SAE J595 Class 1
COMPLIANCE	ECE R65, EMC R10, RoHS
FLASH PATTERNS	26 Flash Patterns
COLOR	Amber
DIODES	6 Diodes
OPERATING VOLTAGE	12-24 Volts
FUNCTIONS	1. Synchronization 2. Alternating Function 3. Last Pattern Recall
HOUSING MATERIAL	Aluminum Die Cast
LENS MATERIAL	Polycarbonate
WATERPROOF RATING	IP65 Rating
SOLD	Individually
WARRANTY	5 Years

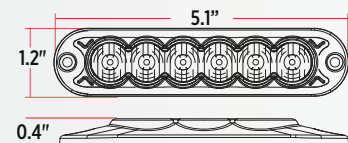

### WIRING

- 4 WIRE CONNECTION
- GROUND
  - PATTERN SELECT
  - POWER
  - SYNCHRONIZATION

Refer to the Installation Instructions in the packaging for the wiring diagram.

**CLASS 1**  
SAE J595

**26**  
FLASH PATTERNS

**L-BRACKET**  
INCLUDED

**3M TAPE**  
INCLUDED

WARNING: Cancer and Reproductive Harm - [www.p65warnings.ca.gov](http://www.p65warnings.ca.gov)

**3 DIODES**  
24 FLASH PATTERNS

**NEW**



3 DIODES  
**TLED-W23A24**

**TECHNICAL SPECIFICATIONS**

CLASSIFICATION	SAE J595 Class 1
COMPLIANCE	ECE R65, EMC R10, RoHS
FLASH PATTERNS	24 Flash Patterns
COLOR	Amber
DIODES	3 Diodes
OPERATING VOLTAGE	12-24 Volts
FUNCTIONS	1. Synchronization 2. Alternating Function 3. Last Pattern Recall
HOUSING MATERIAL	Aluminum Die Cast
LENS MATERIAL	Polycarbonate
WATERPROOF RATING	IP65 Rating
SOLD	Individually
WARRANTY	5 Years



**WIRING**

4 WIRE CONNECTION

- GROUND
- PATTERN SELECT
- POWER
- SYNCHRONIZATION

*Refer to the Installation Instructions in the packaging for the wiring diagram.*

**CLASS 1**  
SAE J595

**24**  
FLASH PATTERNS

**L-BRACKET**  
INCLUDED

**4 DIODES**  
26 FLASH PATTERNS

**NEW**



4 DIODES  
**TLED-W24A26**

**TECHNICAL SPECIFICATIONS**

CLASSIFICATION	SAE J595 Class 1
COMPLIANCE	ECE R65, EMC R10, RoHS
FLASH PATTERNS	26 Flash Patterns
COLOR	Amber
DIODES	4 Diodes
OPERATING VOLTAGE	12-24 Volts
FUNCTIONS	1. Synchronization 2. Alternating Function 3. Last Pattern Recall
HOUSING MATERIAL	Aluminum Die Cast
LENS MATERIAL	Polycarbonate
WATERPROOF RATING	IP65 Rating
SOLD	Individually
WARRANTY	5 Years

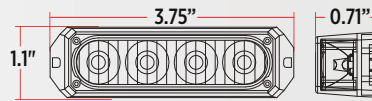

**WIRING**

4 WIRE CONNECTION

- GROUND
- PATTERN SELECT
- POWER
- SYNCHRONIZATION

*Refer to the Installation Instructions in the packaging for the wiring diagram.*

**CLASS 1**  
SAE J595

**26**  
FLASH PATTERNS

**L-BRACKET**  
INCLUDED

**6 DIODES**  
26 FLASH PATTERNS

**NEW**



6 DIODES  
**TLED-W26A26**

**TECHNICAL SPECIFICATIONS**

CLASSIFICATION	SAE J595 Class 1
COMPLIANCE	ECE R65, EMC R10, RoHS
FLASH PATTERNS	26 Flash Patterns
COLOR	Amber
DIODES	6 Diodes
OPERATING VOLTAGE	12-24 Volts
FUNCTIONS	1. Synchronization 2. Alternating Function 3. Last Pattern Recall
HOUSING MATERIAL	Aluminum Die Cast
LENS MATERIAL	Polycarbonate
WATERPROOF RATING	IP65 Rating
SOLD	Individually
WARRANTY	5 Years

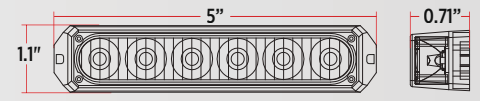

**WIRING**

4 WIRE CONNECTION

- GROUND
- PATTERN SELECT
- POWER
- SYNCHRONIZATION

*Refer to the Installation Instructions in the packaging for the wiring diagram.*

**CLASS 1**  
SAE J595

**26**  
FLASH PATTERNS

**L-BRACKET**  
INCLUDED

# LED WORK LAMPS

## PAR4411 REPLACEMENT FLOOD BEAM



FLOOD BEAM  
**TLED-U47**

### TECHNICAL SPECIFICATIONS

RAW LUMENS	660 Lumens
EFFECTIVE LUMENS	650 Lumens
BEAM PATTERN	Flood Beam
DIODES	6 Diodes
OPERATING VOLTAGE	12 Volts
LED POWER	10.2 Watts
CURRENT DRAW	0.85 Amps @ 12 Volts
COLOR TEMPERATURE	6000 Kelvin
HOUSING MATERIAL	Aluminum Die Cast
LENS MATERIAL	Polycarbonate
WATERPROOF RATING	IP67 Rating
SOLD	Individually
WARRANTY	3 Years

### BEAM PATTERN

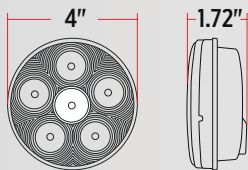
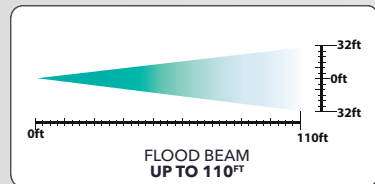

### WIRING

**660 LUMENS** **FLOOD BEAM**

## FLASHLIGHT WITH 180° MAGNETIC CLIP - BOX OF 12



**TLED-FLA1**  
BOX CONTAINS  
**12 x TLED-FLA1X**



SPOT BEAM  
**TLED-FLA1** Box of 12

### TECHNICAL SPECIFICATIONS

EFFECTIVE LUMENS	140 Lumens
HOUSING COLOR	Black & Grey
SOLD	Box of 12
WARRANTY	3 Years

**140 LUMENS**

**180° MAGNETIC SWIVEL CLIP**

**BATTERIES INCLUDED**



# SINGLE ROW COMBINATION SPOT & FLOOD BEAM

7"  
TLED-U36 ▶



12"  
TLED-U50 ▶



**FEATURES & BENEFITS**

- ▶ Spot & Flood Beam Pattern
- ▶ Wire Harness & Bracket Included
- ▶ IP67 Waterproof Rating
- ▶ 6000 Kelvin Color Temperature
- ▶ Strong & Durable Polycarbonate Lens
- ▶ Sold Individually
- ▶ 3 Year Warranty

**TECHNICAL SPECIFICATIONS**

PART NUMBER	TLED-U36	TLED-U50
LENGTH	7"	12"
EFFECTIVE LUMENS	1260 Lumens	2520 Lumens
DIODES	6 Diodes	12 Diodes
OPERATING VOLTAGE	9-32 Volts	10-30 Volts
LED POWER	18 Watts	36 Watts
CURRENT DRAW	1.05 Amps @ 12 Volt	2.1 Amps @ 12 Volts
PRODUCT DIMENSIONS	6.875" x 2" x 2.125"	12" x 1.77" x 2.18"
WARRANTY	3 Years	3 Years

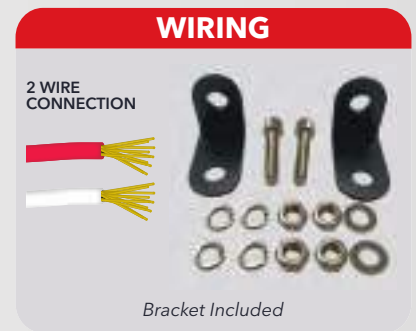

**BEAM PATTERN**

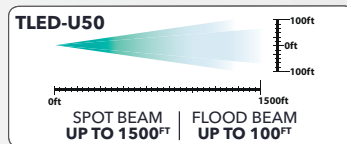
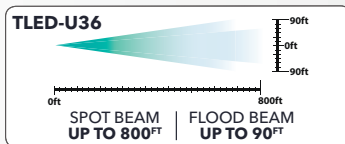

**SPOT & FLOOD BEAM**      **BRACKET INCLUDED**

## ROUND TUBE MOUNTING BRACKETS (PAIR) FOR LED LIGHT BARS



- ◀ ROUND MOUNTING BRACKETS
- TU-1046** 1" Diameter
- TU-1047** 1.25" Diameter
- TU-1048** 1.5" Diameter
- TU-1049** 1.75" Diameter
- TU-1050** 2" Diameter
- TU-1051** 3" Diameter

**TECHNICAL SPECIFICATIONS**

KIT INCLUDES	2 x Brackets 2 x Allen Keys 2 x Adhesive Foam Pads
DESIGNED TO FIT	Bar Diameter based on Part Number
MATERIAL	Steel
WARRANTY	3 Years

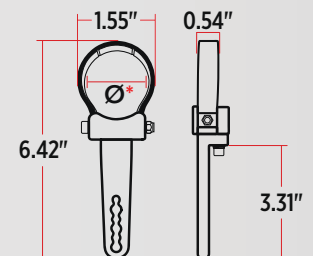

Ø\* Diameter varies based on Part Number.

# LED LIGHT BARS

## DOUBLE ROW COMBINATION SPOT & FLOOD BEAM

14"  
TLED-U65 ▶



22"  
TLED-U66 ▶



32"  
TLED-U67 ▶



42"  
TLED-U68 ▶



50"  
TLED-U69 ▶



### FEATURES & BENEFITS

- ▶ Spot & Flood Beam Pattern
- ▶ Wire Harness & Bracket Included
- ▶ 10-30 Volt Operating Voltage
- ▶ IP67 Waterproof Rating
- ▶ 6000 Kelvin Color Temperature
- ▶ Strong & Durable Polycarbonate Lens
- ▶ Sold Individually
- ▶ 3 Year Warranty

### TECHNICAL SPECIFICATIONS

PART NUMBER	TLED-U65	TLED-U66	TLED-U67	TLED-U68	TLED-U69
LENGTH	14"	22"	32"	42"	50"
RAW LUMENS	7200 Lumens	12000 Lumens	18000 Lumens	24000 Lumens	28800 Lumens
EFFECTIVE LUMENS	2880 Lumens	4800 Lumens	7600 Lumens	9600 Lumens	11520 Lumens
DIODES	24 Diodes	40 Diodes	60 Diodes	80 Diodes	96 Diodes
OPERATING VOLTAGE	10-30 Volts	10-30 Volts	10-30 Volts	10-30 Volts	10-30 Volts
LED POWER	48 Watts	80 Watts	120 Watts	160 Watts	192 Watts
CURRENT DRAW	4 Amps @ 12 Volt	6.67 Amps @ 12 Volts	10 Amps @ 12 Volts	13.33 Amps @ 12 Volts	16 Amps @ 12 Volts
PRODUCT DIMENSIONS	16.5" x 3.5" x 4.5"	24.63" x 3.5" x 4.5"	34.5" x 3.5" x 4.5"	44.5" x 3.5" x 4.5"	52.63" x 3.5" x 4.5"
WARRANTY	3 Years	3 Years	3 Years	3 Years	3 Years

### BEAM PATTERN

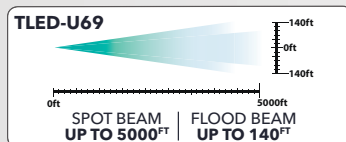
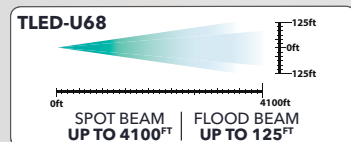
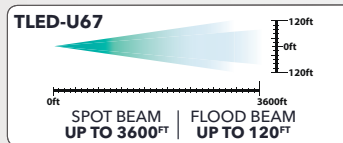
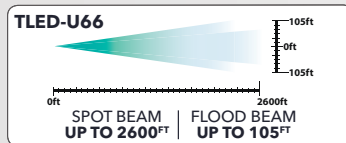
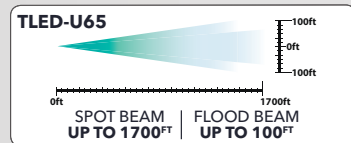

**SPOT & FLOOD BEAM**

**WIRE HARNESS & BRACKET INCLUDED**

### WIRING



⚠ WARNING: Cancer and Reproductive Harm - www.p65warnings.ca.gov

# DOUBLE ROW WITH COVER

## COMBINATION SPOT & FLOOD BEAM

15"  
TLED-U86 ▶



22"  
TLED-U76 ▶



32"  
TLED-U77 ▶



### FEATURES & BENEFITS

- ▶ Spot & Flood Beam Pattern
- ▶ Integrated Locking Pin Cover
- ▶ Wire Harness & Bracket Included
- ▶ 10-30 Volt Operating Voltage
- ▶ IP67 Waterproof Rating
- ▶ 6000 Kelvin Color Temperature
- ▶ Strong & Durable Polycarbonate Lens
- ▶ Sold Individually
- ▶ 3 Year Warranty

### TECHNICAL SPECIFICATIONS

PART NUMBER	TLED-U86	TLED-U76	TLED-U77
LENGTH	15"	22"	32"
RAW LUMENS	7200 Lumens	12000 Lumens	18000 Lumens
EFFECTIVE LUMENS	5040 Lumens	8400 Lumens	12600 Lumens
DIODES	24 Diodes	40 Diodes	60 Diodes
OPERATING VOLTAGE	10-30 Volts	10-30 Volts	10-30 Volts
LED POWER	72 Watts	120 Watts	180 Watts
CURRENT DRAW	4 Amps @ 12 Volt	8.2 Amps @ 12 Volts	13 Amps @ 12 Volts
PRODUCT DIMENSIONS	17.38" x 3.5" x 4.5"	24.63" x 3.5" x 4.5"	34.5" x 3.5" x 4.5"
WARRANTY	3 Years	3 Years	3 Years

### WIRING



Refer to the Installation Instructions in the packaging for the wiring diagram.

**SPOT & FLOOD BEAM**

**WIRE HARNESS & BRACKET INCLUDED**

### BEAM PATTERN

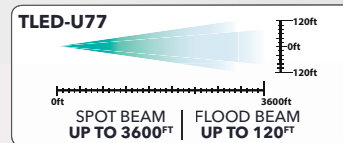
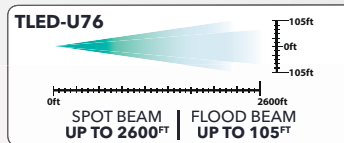
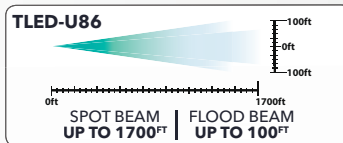

**SOLD IN**  
RETAIL PACKAGING

⚠ WARNING: Cancer and Reproductive Harm - [www.p65warnings.ca.gov](http://www.p65warnings.ca.gov)

# MULTI FUNCTIONALITY AT ITS PEAK!

No light has ever been this cleverly designed! Bringing the revolutionary to the Trux's Dual Revolution line is the latest TLED-OX60RAS & TLED-4X40AS. At the peak of multi-functionality, this Red Stop, Turn & Tail to Amber Multi Pulse Strobe is the most ALL-IN-ONE light ever created. These bad boys have you seen in a flick of a switch!

**INTRODUCING  
DUAL FUNCTION LEDS  
WITH STROBE**

**OVAL**



**TLED-OX60RAS**

**4"**



**TLED-4X40AS**



**RED STOP, TURN & TAIL**



**AMBER STROBE**

Not only are they unique, they're also cost-effective and designed to outperform in any industry:



**WIDE LOAD VEHICLES**



**WRECKERS**



**SERVICE VEHICLES**



**DELIVERY VEHICLES**



### 4" ROUND STROBE - 19 LEDS GROMMET MOUNT - S, T & T TO STROBE



RED S, T & T TO AMBER STROBE  
**TLED-4X40AS**

#### TECHNICAL SPECIFICATIONS

DOT/SAE	DOT To Strobe
DIODES	19 Diodes
FUNCTION	Function 1: Stop, Turn & Tail Function 2: Strobe
CURRENT DRAW	Function 1: 270 mA Function 2: 220 mA~247 mA
LENS MATERIAL	Polycarbonate
WARRANTY	3 Years

#### ACCESSORY OPTIONS

GROMMETS (pg. 115)	TGRO-4R, TGRO-4RC
WIRE HARNESS (pg.117-118)	B612, S Series, TPIG-3W
BEZELS (pg. 113-114)	TBEZ-4LR, TBEZ-4CH2, TBEZ-4CH3, TBEZ-4CH4, TBEZ-4CH5



OFF

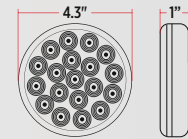

#### WIRING

##### 3 PRONG & BULLET PLUG



##### STROBE

Assemble with any standard 3 Prong Pigtail and Single Female Wire Harness.

### 6" OVAL STROBE - 12 LEDS GROMMET MOUNT - S, T & T TO STROBE



RED S, T & T TO AMBER STROBE  
**TLED-OX60RAS**

#### TECHNICAL SPECIFICATIONS

DOT/SAE	DOT To Strobe
DIODES	12 Diodes
FUNCTION	Function 1: Stop, Turn & Tail Function 2: Strobe
CURRENT DRAW	Function 1: 145 mA Function 2: 145 mA
LENS MATERIAL	Polycarbonate
WARRANTY	3 Years

#### ACCESSORY OPTIONS

GROMMETS	TGRO-OBR, TGRO-OBRC (pg. 115)
WIRE HARNESS	B612, S Series, TPIG-3W (pg. 116-118)
BEZELS	TBEZ-OLR, TBEZ-OBCH2, TBEZ-OBCH3, TBEZ-OBCH4, TBEZ-OBCH5 (pg. 114)

#### WIRING

3 PRONG & BULLET PLUG

S, T & T

STROBE

Assemble with any standard 3 Prong Pigtail and Single Female Wire Harness.

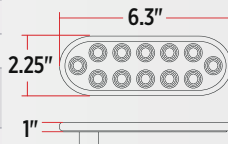

### 6" OVAL STROBE - 12 LEDS GROMMET MOUNT - MARKER TO STROBE



AMBER STROBE  
**TLED-OX60AS**

#### TECHNICAL SPECIFICATIONS

DOT/SAE	DOT To Strobe
DIODES	12 Diodes
FUNCTION	Strobe
CURRENT DRAW	Function 1: 145 mA Function 2: 145 mA
LENS MATERIAL	Polycarbonate
WARRANTY	3 Years

#### ACCESSORY OPTIONS

GROMMETS	TGRO-OBR, TGRO-OBRC (pg. 115)
WIRE HARNESS	B612, S Series, TPIG-3W (pg. 116-118)
BEZELS	TBEZ-OLR, TBEZ-OBCH2, TBEZ-OBCH3, TBEZ-OBCH4, TBEZ-OBCH5 (pg. 114)

#### WIRING

3 PRONG & BULLET PLUG

TURN & MARKER

STROBE

Assemble with any standard 3 Prong Pigtail and Single Female Wire Harness.

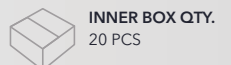
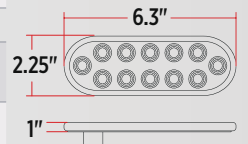

# DUAL REVOLUTION LED

## 4" ROUND - 19 LEDS GROMMET | FLANGE MOUNT - S, T & T TO BACK UP



**FUNCTION 1**  
RED STOP, TURN & TAIL

**FUNCTION 2**  
WHITE BACK UP

### TECHNICAL SPECIFICATIONS

DOT/SAE	Compliant	CURRENT DRAW	Function 1: 270 mA Function 2: 220 mA
DIODES	19 Diodes	LENS MATERIAL	Polycarbonate
FUNCTION	Function 1: Stop, Turn & Tail Function 2: Back Up	WARRANTY	3 Years

### FEATURES & BENEFITS

- 2 Functions in 1 light
- Revolutionary Technology
- Easy Installation
- Greater visibility with **WHITE BACK UP** Function
- Grommet & Flange Mount Models

### MEASUREMENTS

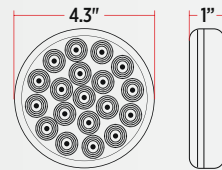

### 4X40 WIRING

3 PRONG & BULLET PLUG



Assemble with any standard 3 Prong Pigtail and Single Female Harness.

WIRING  
S, T & T  
BACK UP

3 PRONG WITH EXTRA BULLET PLUG  
**TLED-4X40** Grommet

INCLUDES EXTENSION

SUPER SEAL ADAPTER  
**TLED-4X40T** Grommet

INCLUDES EXTENSION

LOCK CONNECTOR ADAPTER  
**TLED-4X40G** Grommet

WIRING  
S, T & T  
BACK UP

3 FEMALE PRONG ADAPTER  
**TLED-4X40F** Flange Mount

### ACCESSORY OPTIONS

GROMMETS (pg. 115)	TGRO-4R, TGRO-4RC
WIRE HARNESS (pg.116-118)	B612, S Series, TPIG-3W
BEZELS (pg. 113-114)	TBEZ-4CH2, TBEZ-4CH3, TBEZ-4CH4, TBEZ-4CH5, TBEZ-4LR

TLED-4X40, TLED-4X40T,  
TLED-4X40G:



TLED-4X40F:

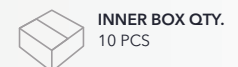

⚠ WARNING: Cancer and Reproductive Harm - [www.p65warnings.ca.gov](http://www.p65warnings.ca.gov)

### TOP SELLER

## 4" ROUND S, T & T TO BACK UP LEDS ARE NOW AVAILABLE IN A POS BOX

TRX-237

SEE PAGE 314 FOR MORE INFORMATION



### 6" OVAL - 12 LEDS

GROMMET MOUNT - S, T & T TO BACK UP

**TOP SELLER**

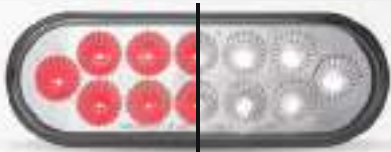

RED S, T & T TO WHITE BACK UP  
**TLED-OX60R**

#### TECHNICAL SPECIFICATIONS

DOT/SAE	Compliant
DIODES	12 Diodes
FUNCTION	Function 1: Stop, Turn & Tail Function 2: Back Up
CURRENT DRAW	Function 1: 145 mA Function 2: 132 mA
LENS MATERIAL	Polycarbonate
WARRANTY	3 Years

#### ACCESSORY OPTIONS

GROMMETS	TGRO-OBR, TGRO-OBRC (pg. 115)
WIRE HARNESS	B612, S Series, TPIG-3W (pg. 116-118)
BEZELS	TBEZ-OLR, TBEZ-OBCH2, TBEZ-OBCH3, TBEZ-OBCH4, TBEZ-OBCH5 (pg. 114)

#### WIRING

3 PRONG & BULLET PLUG



BACK UP

Assemble with any standard 3 Prong Pigtail and Single Female Wire Harness.

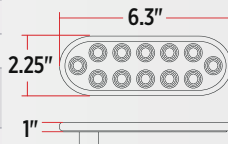

CASE QTY.  
100 PCS



INNER BOX QTY.  
20 PCS

### 3/4" ROUND - 2 LEDS

GROMMET MOUNT - S, T & T TO BACK UP



RED S, T & T TO WHITE BACK UP  
**TLED-BX40**

#### TECHNICAL SPECIFICATIONS

DOT/SAE	Compliant
DIODES	2 Diodes
FUNCTION	Function 1: Stop, Turn & Tail Function 2: Back Up
CURRENT DRAW	Function 1: 30 mA Function 2: 28 mA
LENS MATERIAL	Polycarbonate
WARRANTY	3 Years

#### ACCESSORY OPTIONS

WIRE HARNESS	T Series, S Series (pg. 117-118)
--------------	----------------------------------

#### WIRING

4 BULLET PLUGS



Assemble with any Triple Female Wire Harness and Single Female Wire Harness.

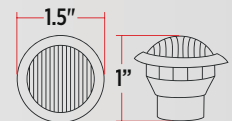

CASE QTY.  
100 PCS



INNER BOX QTY.  
20 PCS

# DUAL REVOLUTION LED

## 4" FLATLINE - 49 LEDS FLANGE MOUNT - S, T & T TO BACK UP



[ PATENTED DESIGN ]

RED S, T & T TO WHITE BACK UP  
**TLED-FX72**

### TECHNICAL SPECIFICATIONS

DIODES	49 Diodes
FUNCTION	Function 1: Stop, Turn & Tail Function 2: Auxiliary
CURRENT DRAW	250 mA
LENS MATERIAL	Polycarbonate
WARRANTY	3 Years

### ACCESSORY OPTIONS

WIRE HARNESS	B612, S Series, TPIG-3W (pg. 116-118)
--------------	--

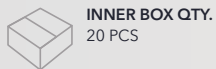

### WIRING

3 PRONG & BULLET PLUG



Assemble with any standard 3 Prong Pigtail and Single Female Wire Harness.

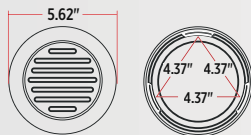

## 4" FLATLINE - 49 LEDS GROMMET MOUNT - S, T & T TO BACK UP



[ PATENTED DESIGN ]

RED S, T & T TO WHITE BACK UP  
**TLED-FX73**

### TECHNICAL SPECIFICATIONS

DIODES	49 Diodes
FUNCTION	Function 1: Stop, Turn & Tail Function 2: Auxiliary
CURRENT DRAW	138 mA
LENS MATERIAL	Polycarbonate
WARRANTY	3 Years

### ACCESSORY OPTIONS

WIRE HARNESS	B612, S Series, TPIG-3W (pg. 116-118)
--------------	--

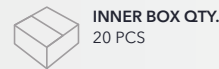

### WIRING

3 PRONG & BULLET PLUG



Assemble with any standard 3 Prong Pigtail and Single Female Wire Harness.



## 6" SLIM - 9 LEDS S, T & T TO AUXILIARY

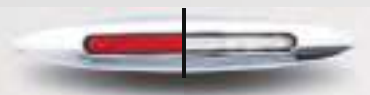

[ PATENTED DESIGN ]

RED S, T & T TO WHITE AUX.  
**TLED-FX76**

### TECHNICAL SPECIFICATIONS

DIODES	9 Diodes
FUNCTION	Function 1: Stop, Turn & Tail Function 2: Auxiliary
CURRENT DRAW	Function 1: 50 mA Function 2: 70 mA
LENS MATERIAL	Polycarbonate
WARRANTY	3 Years

### ACCESSORY OPTIONS

WIRE HARNESS	T Series (pg. 118)
--------------	--------------------

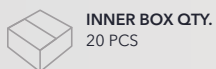

### WIRING

3 BULLET PLUGS & TERMINAL



Assemble with any Triple Female Wire Harness.

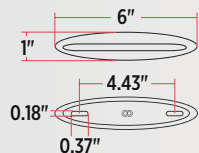

## 17" SLIM - 24 LEDS S, T & T TO AUXILIARY

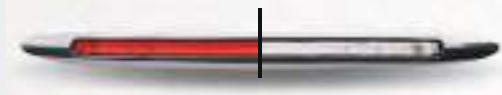

RED S, T & T TO WHITE AUX.  
**TLED-FX78**

### TECHNICAL SPECIFICATIONS

DIODES	24 Diodes
FUNCTION	Function 1: Stop, Turn & Tail Function 2: Auxiliary
CURRENT DRAW	Function 1: 150 mA Function 2: 170 mA
LENS MATERIAL	Polycarbonate
WARRANTY	3 Years

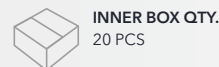

### WIRING

4 WIRES

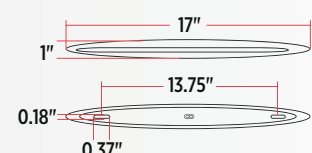

⚠ WARNING: Cancer and Reproductive Harm - [www.p65warnings.ca.gov](http://www.p65warnings.ca.gov)

# FROM ROAD TO SHOW TWO COLORS IN ONE LIGHT

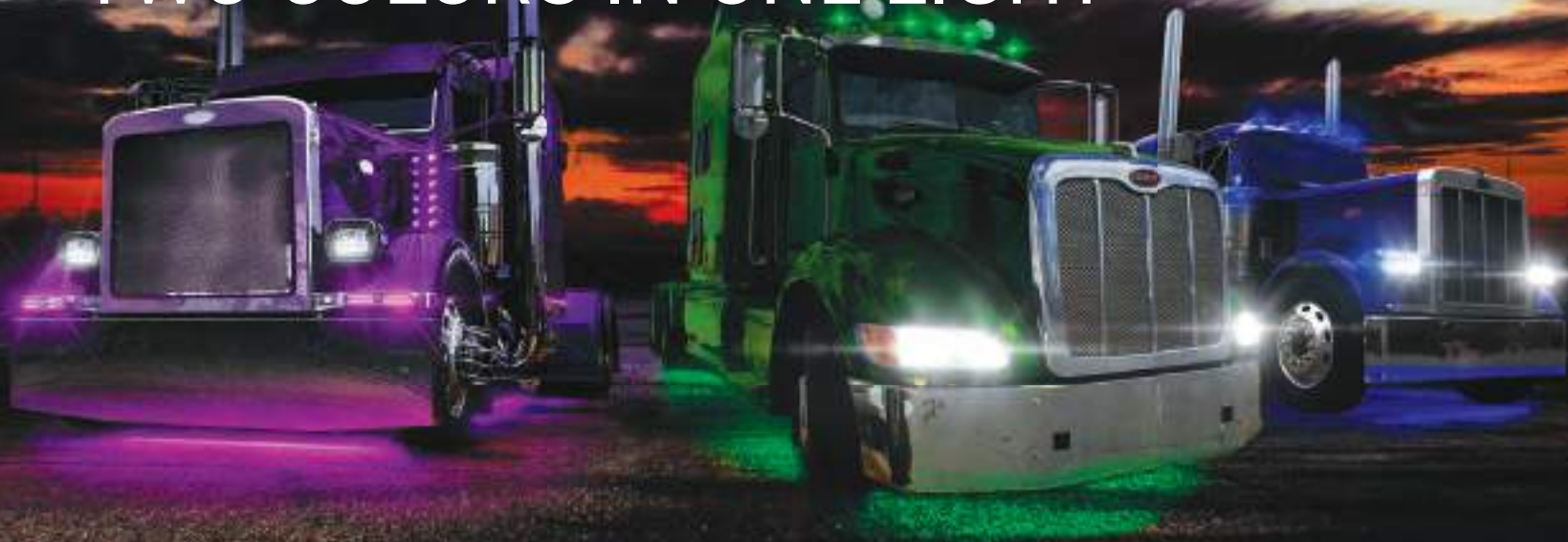

**DOT COMPLIANT**  
**RED | AMBER**  
STOP, TURN & TAIL | TURN SIGNAL & MARKER



**AUXILIARY**  
**GREEN | PURPLE | BLUE**  
**RED | AMBER | WHITE**



**DOT COMPLIANT  
FUNCTION**

**AUXILIARY  
FUNCTION**

**DUAL REVOLUTION**  
**ALL-IN-ONE LEDS**

# DUAL REVOLUTION LED

**TOP  
SELLER**

## 4" ROUND - 19 LEDS GROMMET MOUNT - S, T & T TO AUXILIARY



RED S, T & T TO BLUE AUX.  
**TLED-4XRB**



RED S, T & T TO PURPLE AUX.  
**TLED-4XRP**



RED S, T & T TO GREEN AUX.  
**TLED-4XRG**



RED S, T & T TO AMBER AUX.  
**TLED-4X40A**

### TECHNICAL SPECIFICATIONS

DOT/SAE	DOT To Auxiliary
DIODES	19 Diodes
FUNCTION	Function 1: Stop, Turn & Tail Function 2: Auxiliary
CURRENT DRAW	Function 1: 270 mA Function 2: 220 mA~247 mA
LENS MATERIAL	Polycarbonate
WARRANTY	3 Years

### ACCESSORY OPTIONS

GROMMETS (pg. 115)	TGRO-4R, TGRO-4RC
WIRE HARNESS (pg.116-118)	B612, S Series, TPIG-3W
BEZELS (pg. 113-114)	TBEZ-4LR, TBEZ-4CH2, TBEZ-4CH3, TBEZ-4CH4, TBEZ-4CH5



CASE QTY.  
100 PCS



INNER BOX QTY.  
20 PCS



OFF

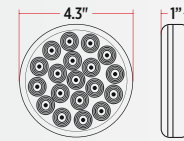

**WIRING**

**3 PRONG & BULLET PLUG**

S, T & T  
AUX.

*Assemble with any standard  
3 Prong Pigtail and Single  
Female Wire Harness.*

## 4" ROUND - 19 LEDS GROMMET MOUNT - TURN & MARKER TO AUXILIARY



AMBER TURN & MARKER TO BLUE AUX.  
**TLED-4XAB**



AMBER TURN & MARKER TO GREEN AUX.  
**TLED-4XAG**



AMBER TURN & MARKER TO WHITE AUX.  
**TLED-4X40AW**

### TECHNICAL SPECIFICATIONS

DOT/SAE	DOT To Auxiliary
DIODES	19 Diodes
FUNCTION	Function 1: Turn & Marker Function 2: Auxiliary
CURRENT DRAW	Function 1: 270 mA Function 2: 247 mA
LENS MATERIAL	Polycarbonate
WARRANTY	3 Years

### ACCESSORY OPTIONS

GROMMETS (pg. 115)	TGRO-4R, TGRO-4RC
WIRE HARNESS (pg.116-118)	B612, S Series, TPIG-3W
BEZELS (pg. 113-114)	TBEZ-4LR, TBEZ-4CH2, TBEZ-4CH3, TBEZ-4CH4, TBEZ-4CH5



CASE QTY.  
100 PCS



INNER BOX QTY.  
20 PCS



OFF

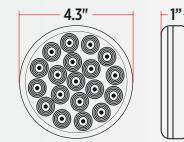

**WIRING**

**3 PRONG & BULLET PLUG**

TURN &  
MARKER  
AUX.

*Assemble with any standard  
3 Prong Pigtail and Single  
Female Wire Harness.*

**WARNING:** Cancer and Reproductive Harm - [www.p65warnings.ca.gov](http://www.p65warnings.ca.gov)

### 4" ROUND - 19 LEDS FLANGE MOUNT - S, T & T TO AUXILIARY



RED S, T & T TO BLUE AUX.  
**TLED-4XRBF**



RED S, T & T TO PURPLE AUX.  
**TLED-4XRPF**



RED S, T & T TO GREEN AUX.  
**TLED-4XRGF**

#### TECHNICAL SPECIFICATIONS

DOT/SAE	DOT To Auxiliary
DIODES	19 Diodes
FUNCTION	Function 1: Stop, Turn & Tail Function 2: Auxiliary
CURRENT DRAW	Function 1: 270 mA~280 mA Function 2: 211 mA~247 mA
LENS MATERIAL	Polycarbonate
WARRANTY	3 Years

#### ACCESSORY OPTIONS

WIRE HARNESS (pg. 116-118) B612, S Series, TPIG-3W



CASE QTY.  
50 PCS



INNER BOX QTY.  
10 PCS



OFF

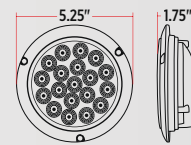

#### WIRING

3 PRONG & BULLET PLUG



Assemble with any standard  
3 Prong Pigtail and Single  
Female Wire Harness.



# DUAL REVOLUTION LED

## 6" OVAL - 12 LEDS GROMMET MOUNT - TURN & MARKER TO AUXILIARY

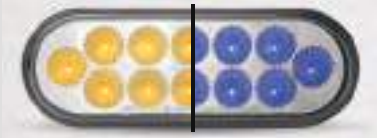

AMBER TURN & MARKER TO BLUE AUX.  
**TLED-OXAB**

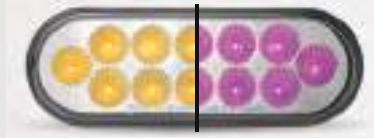

AMBER TURN & MARKER TO PURPLE AUX.  
**TLED-OXAP**

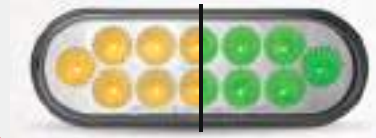

AMBER TURN & MARKER TO GREEN AUX.  
**TLED-OXAG**



AMBER TURN & MARKER TO RED AUX.  
**TLED-OXAR**

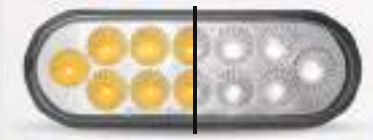

AMBER TURN & MARKER TO WHITE AUX.  
**TLED-OX60A**

### TECHNICAL SPECIFICATIONS

DOT/SAE	DOT To Auxiliary
DIODES	12 Diodes
FUNCTION	Function 1: Turn & Marker Function 2: Auxiliary
CURRENT DRAW	Function 1: 145 mA~152 mA Function 2: 123 mA~130 mA
LENS MATERIAL	Polycarbonate
WARRANTY	3 Years

### ACCESSORY OPTIONS

GROMMETS (pg. 115)	TGRO-OBR, TGRO-OBRC
WIRE HARNESS (pg. 116-118)	B612, S Series, TPIG-3W
BEZELS (pg. 114)	TBEZ-OLR, TBEZ-OBCH2, TBEZ-OBCH3, TBEZ-OBCH4

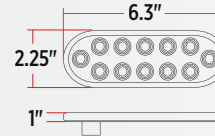

### WIRING

3 PRONG & BULLET PLUG



TURN & MARKER

AUX.

Assemble with any standard 3 Prong Pigtail and Single Female Wire Harness.

## 6" OVAL - 12 LEDS GROMMET MOUNT - S, T & T TO AUXILIARY

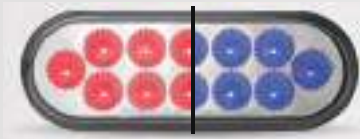

RED S, T & T TO BLUE AUX.  
**TLED-OXR**

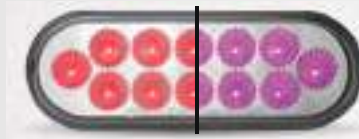

RED S, T & T TO PURPLE AUX.  
**TLED-OXRP**

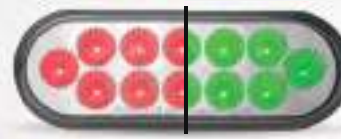

RED S, T & T TO GREEN AUX.  
**TLED-OXRG**

### TECHNICAL SPECIFICATIONS

DOT/SAE	DOT To Auxiliary
DIODES	12 Diodes
FUNCTION	Function 1: Stop, Turn & Tail Function 2: Auxiliary
CURRENT DRAW	Function 1: 145 mA~152 mA Function 2: 123~131 mA
LENS MATERIAL	Polycarbonate
WARRANTY	3 Years

### ACCESSORY OPTIONS

GROMMETS (pg. 115)	TGRO-OBR, TGRO-OBRC
WIRE HARNESS (pg. 116-118)	B612, S Series, TPIG-3W
BEZELS (pg. 114)	TBEZ-OLR, TBEZ-OBCH2, TBEZ-OBCH3, TBEZ-OBCH4

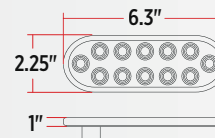

### WIRING

3 PRONG & BULLET PLUG



S, T & T

AUX.

Assemble with any standard 3 Prong Pigtail and Single Female Wire Harness.

WARNING: Cancer and Reproductive Harm - www.p65warnings.ca.gov



**TOP  
SELLER**

### 3/4" ROUND - 2 LEDS GROMMET & BEZEL - MARKER TO AUXILIARY



▲ AMBER MARKER TO BLUE AUX.  
**TLED-BX3AB**



▲ AMBER MARKER TO PURPLE AUX.  
**TLED-BX3AP**



▲ AMBER MARKER TO GREEN AUX.  
**TLED-BX3AG**



▲ AMBER MARKER TO RED AUX.  
**TLED-BX3AR**



▲ AMBER MARKER TO WHITE AUX.  
**TLED-BX3AW**



▲ RED MARKER TO WHITE AUX.  
**TLED-BX3RW**



▲ RED MARKER TO BLUE AUX.  
**TLED-BX3RB**



▲ RED MARKER TO PURPLE AUX.  
**TLED-BX3RP**



▲ RED MARKER TO GREEN AUX.  
**TLED-BX3RG**

#### TECHNICAL SPECIFICATIONS

DOT/SAE	DOT To Auxiliary
DIODES	2 Diodes
FUNCTION	Function 1: Marker Function 2: Auxiliary
CURRENT DRAW	Function 1: 30 mA Function 2: 28 mA
LENS MATERIAL	Polycarbonate
WARRANTY	3 Years

#### ACCESSORY OPTIONS

WIRE HARNESS (pg. 117-118) T Series



CASE QTY.  
100 PCS



INNER BOX QTY.  
20 PCS



OFF

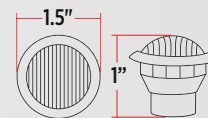

#### WIRING

3 BULLET PLUGS



Assemble with any Triple Female Wire Harness.

# DUAL REVOLUTION LED

**NEW**

**3/4" ROUND - 1 LED**  
GROMMET, TWIST ON NUT & BEZEL - MARKER TO AUXILIARY



▲ AMBER MARKER TO BLUE AUX.  
**TLED-BX1AB**



▲ AMBER MARKER TO PURPLE AUX.  
**TLED-BX1AP**



▲ AMBER MARKER TO GREEN AUX.  
**TLED-BX1AG**



▲ AMBER MARKER TO RED AUX.  
**TLED-BX1AR**



▲ AMBER MARKER TO WHITE AUX.  
**TLED-BX1AW**



▲ RED MARKER TO WHITE AUX.  
**TLED-BX1RW**



▲ RED MARKER TO BLUE AUX.  
**TLED-BX1RB**



▲ RED MARKER TO PURPLE AUX.  
**TLED-BX1RP**



▲ RED MARKER TO GREEN AUX.  
**TLED-BX1RG**

## TECHNICAL SPECIFICATIONS

DOT/SAE	DOT To Auxiliary
DIODES	1 Diode
FUNCTION	Function 1: Marker Function 2: Auxiliary
CURRENT DRAW	Function 1: 30 mA Function 2: 30 mA
LENS MATERIAL	Polycarbonate
WARRANTY	3 Years

## ACCESSORY OPTIONS

WIRE HARNESS (pg. 117-118) T Series



CASE QTY.  
100 PCS



INNER BOX QTY.  
20 PCS



OFF

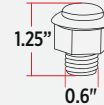
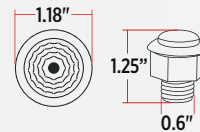

## 2-IN-1 INSTALLATION

New and Improved 3/4" Round LEDs come with Two Installation Options:

### GROMMET INSTALLATION



### NUT & THREAD INSTALLATION



## WIRING

3 BULLET PLUGS



Assemble with any Triple Female Wire Harness.



⚠ WARNING: Cancer and Reproductive Harm - [www.p65warnings.ca.gov](http://www.p65warnings.ca.gov)

### 3/4" OVAL - 2 LEDS GROMMET & BEZEL - MARKER TO AUXILIARY



▲ AMBER MARKER TO BLUE AUX.  
**TLED-BX4AB**

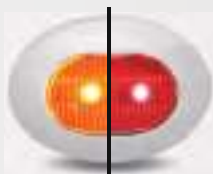

▲ AMBER MARKER TO RED AUX.  
**TLED-BX4AR**



▲ AMBER MARKER TO WHITE AUX.  
**TLED-BX4AW**

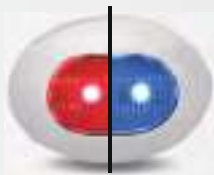

▲ RED MARKER TO BLUE AUX.  
**TLED-BX4RB**



▲ RED MARKER TO WHITE AUX.  
**TLED-BX4RW**

#### TECHNICAL SPECIFICATIONS

DOT/SAE	DOT To Auxiliary
DIODES	2 Diodes
FUNCTION	Function 1: Marker Function 2: Auxiliary
CURRENT DRAW	Function 1: 30 mA Function 2: 28 mA
LENS MATERIAL	Polycarbonate
WARRANTY	3 Years

#### ACCESSORY OPTIONS

WIRE HARNESS (pg. 117-118) | T Series



CASE QTY.  
100 PCS



INNER BOX QTY.  
20 PCS



OFF

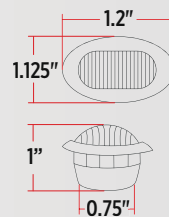

#### WIRING

3 BULLET PLUGS



Assemble with any Triple Female Wire Harness.



⚠ WARNING: Cancer and Reproductive Harm - [www.p65warnings.ca.gov](http://www.p65warnings.ca.gov)

# DUAL REVOLUTION LED

## 2" ROUND - 7 LEDS GROMMET MOUNT - MARKER TO AUXILIARY



▲ AMBER MARKER TO BLUE AUX.  
**TLED-2XAB**



▲ AMBER MARKER TO PURPLE AUX.  
**TLED-2XAP**



▲ AMBER MARKER TO GREEN AUX.  
**TLED-2XAG**



▲ AMBER MARKER TO RED AUX.  
**TLED-2XAR**



▲ RED MARKER TO BLUE AUX.  
**TLED-2XRB**



▲ RED MARKER TO PURPLE AUX.  
**TLED-2XRP**



▲ RED MARKER TO GREEN AUX.  
**TLED-2XRG**



▲ RED MARKER TO WHITE AUX.  
**TLED-2XRW**

### TECHNICAL SPECIFICATIONS

DOT/SAE	DOT To Auxiliary
DIODES	7 Diodes
FUNCTION	Function 1: Marker Function 2: Auxiliary
CURRENT DRAW	Function 1: 67 mA Function 2: 63 mA
LENS MATERIAL	Polycarbonate
WARRANTY	3 Years

### ACCESSORY OPTIONS

GROMMETS (pg. 115)	TGRO-2R, TGRO-2RC
WIRE HARNESS (pg. 116-118)	B Series, S Series, TPIG-2W
BEZELS (pg. 113)	TBEZ-2CH2, TBEZ-2CH3, TBEZ-2CH4, TBEZ-2CH5



CASE QTY.  
100 PCS



INNER BOX QTY.  
20 PCS



OFF



2"



1"

### WIRING

2 PRONG & BULET PLUG



MARKER

AUX.

Assemble with any standard  
2 Prong Pigtail and Single  
Female Wire Harness.



⚠ WARNING: Cancer and Reproductive Harm - [www.p65warnings.ca.gov](http://www.p65warnings.ca.gov)

## 2.5" ROUND - 7 LEDS GROMMET MOUNT - MARKER TO AUXILIARY



AMBER MARKER TO BLUE AUX.  
**TLED-2HXAB**



AMBER MARKER TO PURPLE AUX.  
**TLED-2HXAP**



AMBER MARKER TO GREEN AUX.  
**TLED-2HXAG**



RED MARKER TO BLUE AUX.  
**TLED-2HXRБ**



RED MARKER TO PURPLE AUX.  
**TLED-2HXRP**



RED MARKER TO GREEN AUX.  
**TLED-2HXRG**



RED MARKER TO WHITE AUX.  
**TLED-2HXRW**

### TECHNICAL SPECIFICATIONS

DOT/SAE	DOT To Auxiliary
DIODES	7 Diodes
FUNCTION	Function 1: Marker Function 2: Auxiliary
CURRENT DRAW	Function 1: 110 mA Function 2: 85 mA ~ 90 mA
LENS MATERIAL	Polycarbonate
WARRANTY	3 Years

### ACCESSORY OPTIONS

GROMMETS (pg. 115)	TGRO-2HR, TGRO-2HRO
WIRE HARNESS (pg. 116-118)	B Series, S Series, TPIG-2W
BEZELS (pg. 113)	TBEZ-2HCH2, TBEZ-2HCH3, TBEZ-2HCH4, TBEZ-2HCH5



CASE QTY.  
200 PCS

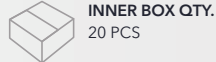

INNER BOX QTY.  
20 PCS



OFF



2.5"



1"

### WIRING

2 PRONG & BULLET PLUG



MARKER



AUX.

Assemble with any standard  
2 Prong Pigtail and Single  
Female Wire Harness.



WARNING: Cancer and Reproductive Harm - [www.p65warnings.ca.gov](http://www.p65warnings.ca.gov)

# DUAL REVOLUTION LED

**TOP  
SELLER**

## GENERATION 4 - 10 LEDS MARKER TO AUXILIARY



▲ AMBER MARKER TO BLUE AUX.  
**TLED-G4XAB**



▲ AMBER MARKER TO PURPLE AUX.  
**TLED-G4XAP**



▲ AMBER MARKER TO GREEN AUX.  
**TLED-G4XAG**



▲ AMBER MARKER TO WHITE AUX.  
**TLED-G4XAW**

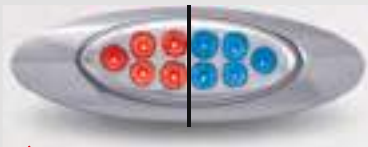

▲ RED MARKER TO BLUE AUX.  
**TLED-G4XRB**

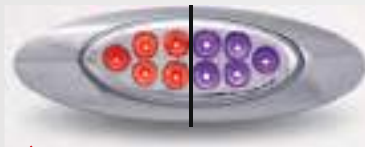

▲ RED MARKER TO PURPLE AUX.  
**TLED-G4XRP**

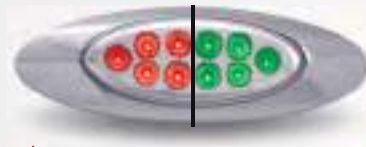

▲ RED MARKER TO GREEN AUX.  
**TLED-G4XRG**

### TECHNICAL SPECIFICATIONS

DOT/SAE	DOT To Auxiliary
DIODES	10 Diodes
FUNCTION	Function 1: Marker Function 2: Auxiliary
CURRENT DRAW	Function 1: 120 mA Function 2: 100 mA
LENS MATERIAL	Polycarbonate
WARRANTY	3 Years

### ACCESSORY OPTIONS

WIRE HARNESS (pg. 118)	T Series
------------------------	----------



CASE QTY.  
100 PCS



INNER BOX QTY.  
10 PCS

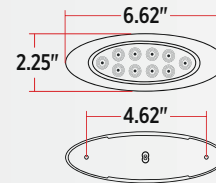

### WIRING

3 BULLET PLUGS



Assemble with any Triple Female Wire Harness.



⚠ WARNING: Cancer and Reproductive Harm - [www.p65warnings.ca.gov](http://www.p65warnings.ca.gov)

### GENERATION 2 - 4 LEDS MARKER TO AUXILIARY



AMBER MARKER TO BLUE AUX.  
**TLED-G2XAB**



AMBER MARKER TO PURPLE AUX.  
**TLED-G2XAP**



AMBER MARKER TO GREEN AUX.  
**TLED-G2XAG**



AMBER MARKER TO WHITE AUX.  
**TLED-G2XAW**

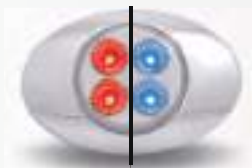

RED MARKER TO BLUE AUX.  
**TLED-G2XRB**

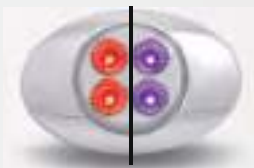

RED MARKER TO PURPLE AUX.  
**TLED-G2XRP**

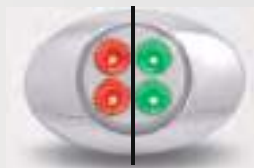

RED MARKER TO GREEN AUX.  
**TLED-G2XRG**



RED MARKER TO WHITE AUX.  
**TLED-G2XRW**

#### TECHNICAL SPECIFICATIONS

DOT/SAE	DOT To Auxiliary
DIODES	4 Diodes
FUNCTION	Function 1: Marker Function 2: Auxiliary
CURRENT DRAW	Function 1: 60 mA Function 2: 63 mA ~ 65 mA
LENS MATERIAL	Polycarbonate
WARRANTY	3 Years

#### ACCESSORY OPTIONS

WIRE HARNESS (pg. 118)	T Series
CASE QTY. 100 PCS	OFF
INNER BOX QTY. 20 PCS	

#### WIRING

3 BULLET PLUGS



Assemble with any Triple Female Wire Harness.

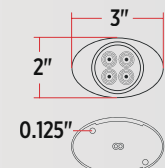

# DUAL REVOLUTION LED

## WATERMELON - 19 LEDS

S, T & T TO AUXILIARY | TURN & MARKER TO AUXILIARY



▲ AMBER TURN & MARKER TO BLUE AUX.  
**TLED-WXAB**



▲ AMBER TURN & MARKER TO PURPLE AUX.  
**TLED-WXAP**



▲ AMBER TURN & MARKER TO GREEN AUX.  
**TLED-WXAG**



▲ AMBER TURN & MARKER TO RED AUX.  
**TLED-WXAR**



▲ AMBER TURN & MARKER TO WHITE AUX.  
**TLED-WXAW**



▲ RED S, T & T TO WHITE AUX.  
**TLED-WXRW**



▲ RED S, T & T TO BLUE AUX.  
**TLED-WXRB**



▲ RED S, T & T TO PURPLE AUX.  
**TLED-WXRP**



▲ RED S, T & T TO GREEN AUX.  
**TLED-WXRG**

### TECHNICAL SPECIFICATIONS

DOT/SAE	DOT To Auxiliary
DIODES	19 Diodes
STOP, TURN & TAIL TO AUXILIARY	TLED-WXRB, TLED-WXRP, TLED-WXRG, TLED-WXRW
TURN & MARKER TO AUXILIARY	TLED-WXAB, TLED-WXAP, TLED-WXAG, TLED-WXAR, TLED-WXAW
CURRENT DRAW	Function 1: 240 mA Function 2: 240 mA
LENS MATERIAL	Polycarbonate
WARRANTY	3 Years

### ACCESSORY OPTIONS

WIRE HARNESS (pg. 117-118) | T Series, S Series

 CASE QTY.  
50 PCS

 INNER BOX QTY.  
10 PCS



OFF

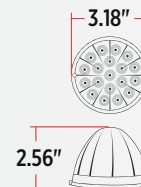

### WIRING

4 BULLET PLUGS



Assemble with any Triple Female Wire Harness and Single Female Wire Harness.

 WARNING: Cancer and Reproductive Harm - [www.p65warnings.ca.gov](http://www.p65warnings.ca.gov)



### PETERBILT CAB - 19 LEDS MARKER TO AUXILIARY



▲ AMBER MARKER TO BLUE AUX.  
**TLED-PCAB2XAB**



▲ AMBER MARKER TO PURPLE AUX.  
**TLED-PCAB2XAP**



▲ AMBER MARKER TO GREEN AUX.  
**TLED-PCAB2XAG**

#### TECHNICAL SPECIFICATIONS

DOT/SAE	DOT To Auxiliary
DIODES	19 Diodes
FUNCTION	Function 1: Marker Function 2: Auxiliary
CURRENT DRAW	Function 1: 270 mA Function 2: 247 mA
LENS MATERIAL	Polycarbonate
WARRANTY	3 Years



CASE QTY.  
20 PCS



INNER BOX QTY.  
5 PCS

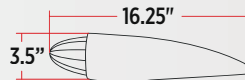

OFF

#### WIRING

3 WIRES



### SQUARE CAB -42 LEDS MARKER TO AUXILIARY



▲ AMBER MARKER TO BLUE AUX.  
**TLED-CAB2XAB**



▲ AMBER MARKER TO PURPLE AUX.  
**TLED-CAB2XAP**



▲ AMBER MARKER TO GREEN AUX.  
**TLED-CAB2XAG**

#### TECHNICAL SPECIFICATIONS

DOT/SAE	DOT To Auxiliary
DIODES	42 Diodes
FUNCTION	Function 1: Marker Function 2: Auxiliary
CURRENT DRAW	Function 1: 470 mA Function 2: 465 mA
LENS MATERIAL	Polycarbonate
WARRANTY	3 Years



CASE QTY.  
20 PCS



INNER BOX QTY.  
5 PCS

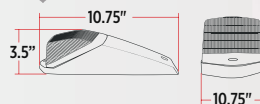

OFF

#### WIRING

3 WIRES



# DUAL REVOLUTION LED

## PETERBILT SIDE HEADLIGHT - 24 LEDS TURN & MARKER TO AUXILIARY



AMBER TURN & MARKER TO **BLUE** AUX.  
**TLED-PSHXB**

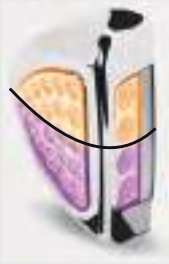

AMBER TURN & MARKER TO **PURPLE** AUX.  
**TLED-PSHXP**

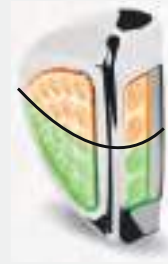

AMBER TURN & MARKER TO **GREEN** AUX.  
**TLED-PSHXG**

### TECHNICAL SPECIFICATIONS

DOT/SAE	DOT To Auxiliary
DIODES	24 Diodes
FUNCTION	Function 1: Turn & Marker Function 2: Auxiliary
CURRENT DRAW	Function 1: 310 mA Function 2: 260 mA
LENS MATERIAL	Polycarbonate
WARRANTY	3 Years



CASE QTY.  
100 PCS



INNER BOX QTY.  
10 PCS



OFF

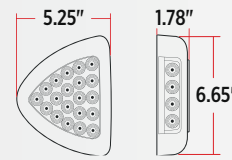

**WIRING**

4 WIRES

MARKER  
 TURN  
 GROUND  
 AUX.

## HEADLIGHT BEZEL - 55 LEDS MARKER TO AUXILIARY

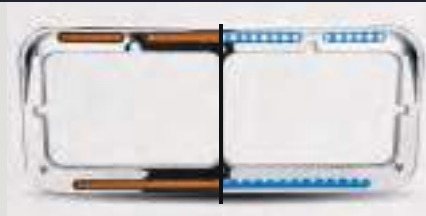

AMBER MARKER TO **BLUE** AUX.  
**TLED-FX106**

### TECHNICAL SPECIFICATIONS

DOT/SAE	DOT To Auxiliary
DIODES	55 Diodes
FUNCTION	Function 1: Marker Function 2: Auxiliary
CURRENT DRAW	Function 1: 550 mA Function 2: 500 mA
LENS MATERIAL	Polycarbonate
WARRANTY	3 Years



CASE QTY.  
20 PCS



INNER BOX QTY.  
4 PCS

**WIRING**

4 WIRES

MARKER  
 (DIM)  
 MARKER  
 (BRIGHT)  
 GROUND  
 AUX.



OFF

## RECTANGULAR - 10 LEDS MARKER TO AUXILIARY



AMBER MARKER TO **BLUE** AUX.  
**TLED-2X6AB**



RED MARKER TO **BLUE** AUX.  
**TLED-2X6RB**

### TECHNICAL SPECIFICATIONS

DOT/SAE	DOT To Auxiliary
DIODES	10 Diodes
FUNCTION	Function 1: Marker Function 2: Auxiliary
CURRENT DRAW	Function 1: 108 mA Function 2: 110 mA
LENS MATERIAL	Polycarbonate
WARRANTY	3 Years

### ACCESSORY OPTIONS

WIRE HARNESS	T Series (pg. 117-118)
--------------	------------------------



CASE QTY.  
100 PCS



INNER BOX QTY.  
20 PCS

**WIRING**

3 BULLET PLUGS

MARKER  
 GROUND  
 AUX.

Assemble with any Triple Female Wire Harness.

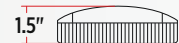
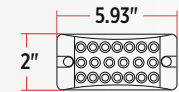

OFF

**WARNING:** Cancer and Reproductive Harm - [www.p65warnings.ca.gov](http://www.p65warnings.ca.gov)

### 0.5" X 17" UNDERMOUNT - 24 LEDS MARKER TO AUXILIARY



▲ AMBER MARKER TO BLUE AUX.  
**TLED-SXAB**



▲ RED MARKER TO BLUE AUX.  
**TLED-SXRB**



▲ AMBER MARKER TO PURPLE AUX.  
**TLED-SXAP**



▲ RED MARKER TO PURPLE AUX.  
**TLED-SXRP**



▲ AMBER MARKER TO GREEN AUX.  
**TLED-SXAG**



▲ RED MARKER TO GREEN AUX.  
**TLED-SXRG**



▲ AMBER MARKER TO RED AUX.  
**TLED-SXAR**

#### TECHNICAL SPECIFICATIONS

DOT/SAE	DOT To Auxiliary
DIODES	24 Diodes
FUNCTION	Function 1: Marker Function 2: Auxiliary
CURRENT DRAW	Function 1: 200 mA Function 2: 210 mA
LENS MATERIAL	Polycarbonate
WARRANTY	3 Years

#### ACCESSORY OPTIONS

WIRE HARNESS (pg. 118)	T Series
------------------------	----------

CASE QTY. 50 PCS  
 INNER BOX QTY. 10 PCS

INSTALLS WITH 3M TAPE & HARDWARE - INCLUDED

#### WIRING

3 BULLET PLUGS



Assemble with any Triple Female Wire Harness.



# DUAL REVOLUTION LED

**NEW**

## ROUND DOUBLE FACE - 38 LEDS TURN & MARKER TO AUXILIARY

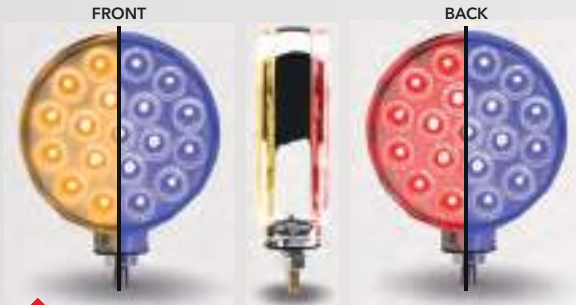

AMBER/RED TURN & MARKER TO **BLUE** AUX.  
**TLED-DFXB**



AMBER/RED TURN & MARKER TO **PURPLE** AUX.  
**TLED-DFXP**



AMBER/RED TURN & MARKER TO **GREEN** AUX.  
**TLED-DFXG**

### TECHNICAL SPECIFICATIONS

DOT/SAE	DOT To Auxiliary
DIODES	38 Diodes
FUNCTION	Function 1: Turn & Marker Function 2: Auxiliary
CURRENT DRAW	Function 1: 180 mA Function 2: 175 mA
LENS MATERIAL	Polycarbonate
WARRANTY	3 Years



CASE QTY.  
50 PCS



INNER BOX QTY.  
10 PCS

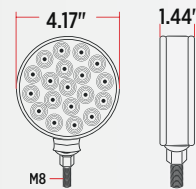

**WIRING**

4 WIRES

- █ MARKER
- █ TURN
- █ GROUND
- █ AUX.



**WARNING:** Cancer and Reproductive Harm - [www.p65warnings.ca.gov](http://www.p65warnings.ca.gov)

**NEW**

### SQUARE DOUBLE FACE - 38 LEDS TURN & MARKER TO AUXILIARY



▲ AMBER/RED TURN & MARKER TO BLUE AUX.  
**TLED-SDXB**



▲ AMBER/RED TURN & MARKER TO PURPLE AUX.  
**TLED-SDXP**

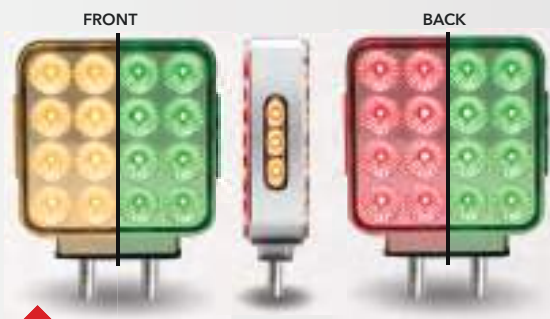

▲ AMBER/RED TURN & MARKER TO GREEN AUX.  
**TLED-SDXG**

#### TECHNICAL SPECIFICATIONS

DOT/SAE	DOT To Auxiliary
DIODES	38 Diodes
FUNCTION	Function 1: Turn & Marker Function 2: Auxiliary
CURRENT DRAW	Function 1: 180 mA Function 2: 175 mA
LENS MATERIAL	Polycarbonate
WARRANTY	3 Years



CASE QTY.  
50 PCS



INNER BOX QTY.  
10 PCS



OFF

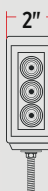
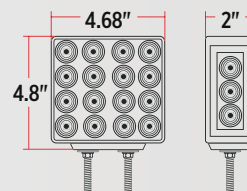

#### WIRING

4 WIRES



# LED LIGHTING



## 4" ROUND - 8 LEDS GROMMET MOUNT - S, T & T

**TOP  
SELLER**



RED S, T & T  
**TLED-48R**



CLEAR RED S, T & T  
**TLED-48CR**



AMBER TURN & MARKER  
**TLED-48A**



RED S, T & T WITH SUPER SEAL ADAPTER  
**TLED-48RT**



RED S, T & T WITH LOCK ADAPTER  
**TLED-48RG**

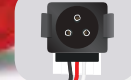

### TECHNICAL SPECIFICATIONS

DOT/SAE	Compliant
DIODES	8 Diodes
STOP, TURN & TAIL	TLED-48R, TLED-48CR, TLED-48RT, TLED-48RG
TURN & MARKER	TLED-48A
CURRENT DRAW	130 mA
LENS MATERIAL	Polycarbonate
WARRANTY	3 Years

### ACCESSORY OPTIONS

GROMMETS (pg. 115)	TGRO-4R, TGRO-4RC
WIRE HARNESS (pg.117-118)	B612, TPIG-3W
BEZELS (pg. 113-114)	TBEZ-4LR, TBEZ-4CH2, TBEZ-4CH3, TBEZ-4CH4, TBEZ-4CH5



CASE QTY.  
100 PCS



INNER BOX QTY.  
20 PCS

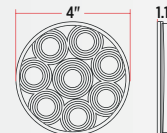

### WIRING

3 PRONG ADAPTER



Assemble with any standard 3 Prong Male Wire Harness.

**WARNING:** Cancer and Reproductive Harm - [www.p65warnings.ca.gov](http://www.p65warnings.ca.gov)

**TRUX'S  
TOP SELLING  
POS DISPLAY**



# 4" STOP, TURN & TAIL POS DISPLAY

**TRX-136 CONTAINS**



**48 X TLED-48R1**

**RED STOP, TURN & TAIL**

**8 DIODES**

**3 YEAR WARRANTY**

**18" x 12" x 9"**

**SEE PAGE 313 FOR MORE INFORMATION**

# LED LIGHTING

## 4" ROUND - 19 LEDS GROMMET MOUNT - S, T & T



RED S, T & T  
**TLED-419R**



CLEAR RED S, T & T  
**TLED-419CR**

### TECHNICAL SPECIFICATIONS

DOT/SAE	Compliant
DIODES	19 Diodes
STOP, TURN & TAIL	TLED-419CR, TLED-419R
CURRENT DRAW	120 mA
LENS MATERIAL	Polycarbonate
WARRANTY	3 Years

### ACCESSORY OPTIONS

GROMMETS (pg. 115)	TGRO-4R, TGRO-4RC
WIRE HARNESS (pg.117-118)	B612, TPIG-3W
BEZELS (pg. 113-114)	TBEZ-4LR, TBEZ-4CH2, TBEZ-4CH3, TBEZ-4CH4, TBEZ-4CH5

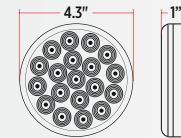
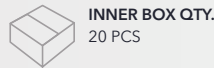

### WIRING

3 PRONG ADAPTER



Assemble with any standard 3 Prong Male Wire Harness.

## 4" ROUND - 19 LEDS GROMMET MOUNT - S, T & T | TURN & MARKER | BACK UP



RED S, T & T  
**TLED-4100R**



AMBER TURN & MARKER  
**TLED-4100A**



WHITE BACK UP  
**TLED-4100W**

### TECHNICAL SPECIFICATIONS

DOT/SAE	Compliant
DIODES	19 Diodes
STOP, TURN & TAIL	TLED-4100R
TURN & MARKER	TLED-4100A
BACK UP	TLED-4100W
CURRENT DRAW	105 mA ~ 140 mA
LENS MATERIAL	Polycarbonate
WARRANTY	3 Years

### ACCESSORY OPTIONS

GROMMETS (pg. 115)	TGRO-4R, TGRO-4RC
WIRE HARNESS (pg.117-118)	B612, TPIG-3W
BEZELS (pg. 113-114)	TBEZ-4LR, TBEZ-4CH2, TBEZ-4CH3, TBEZ-4CH4, TBEZ-4CH5

TLED-4100R, TLED-4100A:

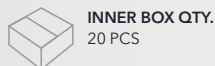

TLED-4100W:

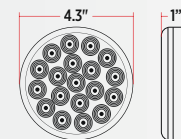
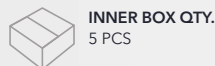

### WIRING

3 PRONG ADAPTER



Assemble with any standard 3 Prong Male Wire Harness.

WARNING: Cancer and Reproductive Harm - www.p65warnings.ca.gov



## 4" ROUND - 19 LEDS

FLANGE MOUNT - S, T & T

**NEW**



RED LENS S, T & T  
**TLED-419RF**



CLEAR RED S, T & T  
**TLED-419CRF**

### TECHNICAL SPECIFICATIONS

DOT/SAE	Compliant
DIODES	19 Diodes
STOP, TURN & TAIL	TLED-419CRF, TLED-419RF
CURRENT DRAW	120 mA
LENS MATERIAL	Polycarbonate
WARRANTY	3 Years

### ACCESSORY OPTIONS

WIRE HARNESS	B612, TPIG-3W (pg. 116-118)
--------------	-----------------------------

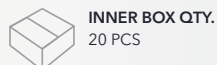

**WIRING**

3 PRONG ADAPTER

Assemble with any standard 3 Prong Male Wire Harness.

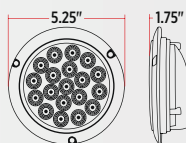

## 4" ROUND - 30+ LEDS

GROMMET MOUNT - S, T & T



RED S, T & T  
**TLED-430R**

### TECHNICAL SPECIFICATIONS

DOT/SAE	Compliant
DIODES	30 Diodes
STOP, TURN & TAIL	TLED-430R
CURRENT DRAW	240 mA ~ 250 mA
LENS MATERIAL	Polycarbonate
WARRANTY	3 Years

### ACCESSORY OPTIONS

GROMMETS	TGRO-4R, TGRO-4RC (pg.115)
WIRE HARNESS	B612, TPIG-3W (pg.117-118)
BEZELS	TBEZ-4LR, TBEZ-4CH2, TBEZ-4CH3, TBEZ-4CH4, TBEZ-4CH5 (p.113-114)

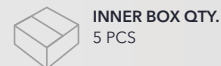

**WIRING**

3 PRONG ADAPTER

Assemble with any standard 3 Prong Male Wire Harness.

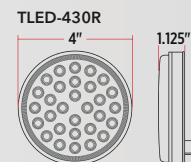

# LED LIGHTING

## 4" ROUND FLATLINE - 49 LEDS GROMMET MOUNT - S, T & T

[ PATENTED DESIGN ]



RED S, T & T  
**TLED-F4R**



CLEAR RED S, T & T  
**TLED-F4CR**

### TECHNICAL SPECIFICATIONS

DIODES	49 Diodes
STOP, TURN & TAIL	TLED-F4R, TLED-F4CR
CURRENT DRAW	138 mA
LENS MATERIAL	Polycarbonate
WARRANTY	3 Years

### ACCESSORY OPTIONS

GROMMETS	TGRO-4R, TGRO-4RC (pg. 115)
WIRE HARNESS	B612, TPIG-3W (pg. 117-118)
BEZELS	TBEZ-4LR, TBEZ-4CH2, TBEZ-4CH3, TBEZ-4CH4, TBEZ-4CH5 (pg. 113-114)



CASE QTY.  
100 PCS



INNER BOX QTY.  
20 PCS

### WIRING

3 PRONG ADAPTER



Assemble with any standard 3 Prong Male Wire Harness.



## 4" ROUND FLATLINE - 49 LEDS FLANGE MOUNT - S, T & T

[ PATENTED DESIGN ]



RED S, T & T  
**TLED-F4R1**



CLEAR RED S, T & T  
**TLED-F4CR1**

### TECHNICAL SPECIFICATIONS

DIODES	49 Diodes
STOP, TURN & TAIL	TLED-F4R1, TLED-F4CR1
CURRENT DRAW	138 mA
LENS MATERIAL	Polycarbonate
WARRANTY	3 Years

### ACCESSORY OPTIONS

WIRE HARNESS	B612, TPIG-3W (pg. 117-118)
--------------	-----------------------------



CASE QTY.  
100 PCS



INNER BOX QTY.  
20 PCS

### WIRING

3 PRONG ADAPTER



Assemble with any standard 3 Prong Male Wire Harness.



## 6" OVAL - 12 LEDS GROMMET MOUNT - S, T & T | TURN & MARKER

**NEW**



AMBER TURN & MARKER  
**TLED-O12A**



CLEAR AMBER TURN & MARKER  
**TLED-O12CA**

**NEW**



RED S, T & T  
**TLED-O12R**



CLEAR RED S, T & T  
**TLED-O12CR**

### TECHNICAL SPECIFICATIONS

DOT/SAE	Compliant
DIODES	12 Diodes
STOP, TURN & TAIL	TLED-O12CR, TLED-O12R
TURN & MARKER	TLED-O12CA, TLED-O12A
CURRENT DRAW	147 mA
LENS MATERIAL	Polycarbonate
WARRANTY	3 Years

### ACCESSORY OPTIONS

GROMMETS (pg. 115)	TGRO-OBR, TGRO-OBRC
WIRE HARNESS (pg. 117-118)	B612, TPIG-3W
BEZELS (pg. 114)	TBEZ-OBCH2, TBEZ-OBCH3, TBEZ-OBCH4, TBEZ-OBCH5, TBEZ-OLR



CASE QTY.  
100 PCS



INNER BOX QTY.  
20 PCS

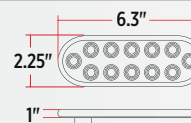

### WIRING

3 PRONG ADAPTER



Assemble with any standard 3 Prong Male Wire Harness.

⚠ WARNING: Cancer and Reproductive Harm - www.p65warnings.ca.gov

## 6" OVAL - 13 LEDS

### GROMMET MOUNT - S,T & T | TURN & MARKER | BACK UP



AMBER TURN & MARKER  
**TLED-OBMA**



CLEAR AMBER TURN & MARKER  
**TLED-OBMCA**



RED S, T & T  
**TLED-OBMR**



CLEAR RED S, T & T  
**TLED-OBMCR**



WHITE BACK UP  
**TLED-OBMW**

#### TECHNICAL SPECIFICATIONS

DOT/SAE	Compliant
DIODES	13 Diodes
STOP, TURN & TAIL	TLED-OBMR, TLED-OBMCR
TURN & MARKER	TLED-OBMA, TLED-OBMCA
BACK UP	TLED-OBMW
CURRENT DRAW	70 mA ~ 110 mA
LENS MATERIAL	Polycarbonate
WARRANTY	3 Years

#### ACCESSORY OPTIONS

GROMMETS (pg. 115)	TGRO-OBR, TGRO-OBRC
WIRE HARNESS (pg. 117-118)	B612, TPIG-3W
BEZELS (pg. 114)	TBEZ-OBCH2, TBEZ-OBCH3, TBEZ-OBCH4, TBEZ-OBCH5, TBEZ-OLR



CASE QTY.  
100 PCS



INNER BOX QTY.  
20 PCS

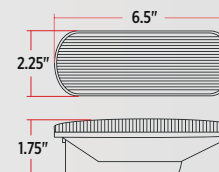

#### WIRING

3 PRONG ADAPTER



Assemble with any standard  
3 Prong Male Wire Harness.

## 3/4" OVAL - 2 LEDS

### GROMMET & BEZEL - MARKER - 3 WIRES



AMBER MARKER  
**TLED-B4A**



CLEAR AMBER MARKER  
**TLED-B4CA**



RED MARKER  
**TLED-B4R**



CLEAR RED MARKER  
**TLED-B4CR**

#### TECHNICAL SPECIFICATIONS

DOT/SAE	Compliant
DIODES	2 Diodes
MARKER	TLED-B4A, TLED-B4CA, TLED-B4R, TLED-B4CR
CURRENT DRAW	34.2 mA
LENS MATERIAL	Polycarbonate
WARRANTY	3 Years

#### ACCESSORY OPTIONS

WIRE HARNESS (pg. 117-118)	T Series
----------------------------	----------



CASE QTY.  
100 PCS



INNER BOX QTY.  
20 PCS

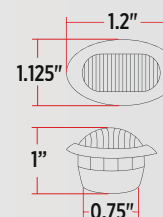

#### WIRING

3 BULLET PLUGS



Assemble with any Triple  
Female Wire Harness.

WARNING: Cancer and Reproductive Harm - www.p65warnings.ca.gov

# LED LIGHTING

**TOP  
SELLER**

## 3/4" ROUND - 3 LEDS GROMMET & BEZEL - MARKER - 2 WIRES



▲ **AMBER MARKER  
TLED-B2A**



▲ **CLEAR AMBER MARKER  
TLED-B2CA**



▲ **RED MARKER  
TLED-B2R**



▲ **CLEAR RED MARKER  
TLED-B2CR**



▲ **AMBER MARKER  
TLED-B5A** Grommet Only



▲ **CLEAR AMBER MARKER  
TLED-B5CA** Grommet Only



▲ **RED MARKER  
TLED-B5R** Grommet Only



▲ **CLEAR RED MARKER  
TLED-B5CR** Grommet Only

### TECHNICAL SPECIFICATIONS

DIODES	3 Diodes
MARKER	TLED-B2A, TLED-B2CA, TLED-B2R, TLED-B2CR, TLED-B5A, TLED-B5CA, TLED-B5R, TLED-B5CR
CURRENT DRAW	40 mA
LENS MATERIAL	Polycarbonate
WARRANTY	3 Years

### ACCESSORY OPTIONS

WIRE HARNESS (pg. 117-118)	D Series
----------------------------	----------

CASE QTY. 100 PCS     INNER BOX QTY. 20 PCS

### GROMMET & BEZEL

#### WIRING

2 BULLET PLUGS



Assemble with any Double Female Wire Harness.

### GROMMET

#### WIRING

2 WIRES



## 3/4" ROUND - 3 LEDS GROMMET & BEZEL - MARKER - 3 WIRES



▲ **AMBER MARKER  
TLED-B3A**



▲ **CLEAR AMBER MARKER  
TLED-B3CA**



▲ **RED MARKER  
TLED-B3R**



▲ **CLEAR RED MARKER  
TLED-B3CR**

### TECHNICAL SPECIFICATIONS

DIODES	3 Diodes
MARKER	TLED-B3A, TLED-B3CA, TLED-B3R, TLED-B3CR
CURRENT DRAW	40 mA
LENS MATERIAL	Polycarbonate
WARRANTY	3 Years

### ACCESSORY OPTIONS

WIRE HARNESS (pg. 117-118)	T Series
----------------------------	----------

CASE QTY. 100 PCS     INNER BOX QTY. 20 PCS

### WIRING

3 BULLET PLUGS



Assemble with any Triple Female Wire Harness.

WARNING: Cancer and Reproductive Harm - www.p65warnings.ca.gov

# TOP SELLERS 3/4" ROUND LEDs ARE NOW AVAILABLE IN A POS BOX



TRX-140: AMBER 3/4" LEDs  
TRX-142: RED 3/4" LEDs

SEE PAGE 309  
FOR MORE INFORMATION



## 3/4" ROUND - 1 LED GROMMET, TWIST ON NUT & BEZEL - MARKER - 2 WIRES



AMBER MARKER  
**TLED-B1A**



CLEAR AMBER MARKER  
**TLED-B1CA**



RED MARKER  
**TLED-B1R**



CLEAR RED MARKER  
**TLED-B1CR**

### 2-IN-1 INSTALLATION

New and Improved 3/4" Round LEDs come with Two Installation Options:

#### GROMMET INSTALLATION



#### NUT & THREAD INSTALLATION



#### TECHNICAL SPECIFICATIONS

DIODES	1 Diode
MARKER	TLED-B1A, TLED-B1CA, TLED-B1R, TLED-B1CR
CURRENT DRAW	35 mA
LENS MATERIAL	Polycarbonate
WARRANTY	3 Years

#### ACCESSORY OPTIONS

WIRE HARNESS (pg. 117-118)	D Series
CASE QTY. 100 PCS	INNER BOX QTY. 20 PCS

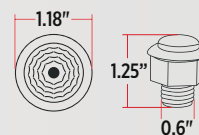

#### WIRING

2 BULLET PLUGS



Assemble with any Double Female Wire Harness.

# LED LIGHTING

## 2" ROUND - 9 LEDS GROMMET MOUNT - MARKER

**TOP  
SELLER**



▲ **AMBER MARKER  
TLED-2A**



▲ **CLEAR AMBER MARKER  
TLED-2TA**



▲ **RED MARKER  
TLED-2R**



▲ **CLEAR RED MARKER  
TLED-2TR**

### TECHNICAL SPECIFICATIONS

DOT/SAE	Compliant
DIODES	9 Diodes
MARKER	TLED-2A, TLED-2TA, TLED-2R, TLED-2TR
CURRENT DRAW	31 mA ~ 39 mA
LENS MATERIAL	Polycarbonate
WARRANTY	3 Years

### ACCESSORY OPTIONS

GROMMETS (pg. 115)	TGRO-2R, TGRO-2RC
WIRE HARNESS (pg. 117-118)	B Series, TPIG-2W
BEZELS (pg. 113)	TBEZ-2CH2, TBEZ-2CH3, TBEZ-2CH4, TBEZ-2CH5

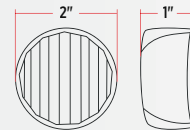
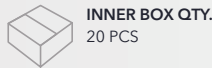

### WIRING

2 PRONG ADAPTER



Assemble with any standard  
2 Prong Male Wire Harness.

**TOP SELLERS**  
2" ROUND LEDS ARE  
NOW AVAILABLE  
IN A POS BOX



TRX-223: AMBER 2" LEDS  
TRX-224: RED 2" LEDS

SEE PAGE 310 FOR MORE  
INFORMATION



⚠ WARNING: Cancer and Reproductive Harm - [www.p65warnings.ca.gov](http://www.p65warnings.ca.gov)

## 2" ROUND - 7 LEDS

### GROMMET MOUNT - MARKER

**NEW**

AMBER MARKER  
**TLED-2XA**



CLEAR AMBER MARKER  
**TLED-2XCA**

**NEW**

RED MARKER  
**TLED-2XR**



CLEAR RED MARKER  
**TLED-2XCR**

**TECHNICAL SPECIFICATIONS**

DOT/SAE	Compliant
DIODES	7 Diodes
MARKER	TLED-2XA, TLED-2XCA, TLED-2XR, TLED-2XCR
CURRENT DRAW	80 mA
LENS MATERIAL	Polycarbonate
WARRANTY	3 Years

**ACCESSORY OPTIONS**

GROMMETS (pg. 115)	TGRO-2R, TGRO-2RC
WIRE HARNESS (pg. 116-118)	B Series, TPIG-2W
BEZELS (pg. 113)	TBEZ-2CH2, TBEZ-2CH3, TBEZ-2CH4, TBEZ-2CH5



CASE QTY.  
100 PCS



INNER BOX QTY.  
20 PCS

**WIRING****2 PRONG ADAPTER**

Assemble with any standard  
2 Prong Male Wire Harness.

## 2" ROUND FLATLINE - 9 LEDS

### GROMMET MOUNT - MARKER

[ PATENTED DESIGN ]



AMBER MARKER  
**TLED-F2A**



CLEAR AMBER MARKER  
**TLED-F2CA**



RED MARKER  
**TLED-F2R**



CLEAR RED MARKER  
**TLED-F2CR**

**TECHNICAL SPECIFICATIONS**

DIODES	9 Diodes
MARKER	TLED-F2A, TLED-F2R, TLED-F2CA, TLED-F2CR
CURRENT DRAW	35 mA
LENS MATERIAL	Polycarbonate
WARRANTY	3 Years

**ACCESSORY OPTIONS**

GROMMETS (pg. 115)	TGRO-2R, TGRO-2RC
WIRE HARNESS (pg. 116-118)	B Series, TPIG-2W
BEZELS (pg. 113)	TBEZ-2CH2, TBEZ-2CH3, TBEZ-2CH4, TBEZ-2CH5



CASE QTY.  
100 PCS



INNER BOX QTY.  
20 PCS

**WIRING****2 PRONG ADAPTER**

Assemble with any standard  
2 Prong Male Wire Harness.

# LED LIGHTING

## TOP SELLERS 2.5" ROUND LEDS ARE NOW AVAILABLE IN A POS BOX



TRX-235: AMBER 2.5" LEDS  
TRX-236: RED 2.5" LEDS

SEE PAGE 311 FOR  
MORE INFORMATION



## 2.5" ROUND - 13 LEDS GROMMET MOUNT - MARKER



▲  
AMBER MARKER  
**TLED-2HA**



▲  
CLEAR AMBER MARKER  
**TLED-2HTA**



▲  
RED MARKER  
**TLED-2HR**



▲  
CLEAR RED MARKER  
**TLED-2HTR**

### TECHNICAL SPECIFICATIONS

DOT/SAE	Compliant
DIODES	13 Diodes
MARKER	TLED-2HA, TLED-2HR, TLED-2HTA, TLED-2HTR
CURRENT DRAW	51 mA ~ 72 mA
LENS MATERIAL	Polycarbonate
WARRANTY	3 Years

### ACCESSORY OPTIONS

GROMMETS (pg. 115)	TGRO-2HRO, TGRO-2HR
WIRE HARNESS (pg. 116-118)	B Series, TPIG-2W
BEZELS (pg. 113)	TBEZ-2HCH2, TBEZ-2HCH3, TBEZ-2HCH4, TBEZ-2HCH5

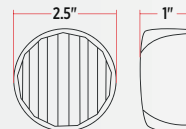
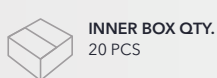

### WIRING

2 PRONG ADAPTER



Assemble with any standard  
2 Prong Male Wire Harness.

⚠ WARNING: Cancer and Reproductive Harm - [www.p65warnings.ca.gov](http://www.p65warnings.ca.gov)



## 2.5" ROUND - 7 LEDS

### GROMMET MOUNT - MARKER



CLEAR AMBER MARKER  
**TLED-2HXCA**



CLEAR RED MARKER  
**TLED-2HXCR**

#### TECHNICAL SPECIFICATIONS

DOT/SAE	Compliant
DIODES	7 Diodes
MARKER	TLED-2HXCA, TLED-2HXCR
CURRENT DRAW	80 mA
LENS MATERIAL	Polycarbonate
WARRANTY	3 Years

#### ACCESSORY OPTIONS

GROMMETS (pg. 115)	TGRO-2HRO, TGRO-2HR
WIRE HARNESS (pg. 116-118)	B Series, TPIG-2W
BEZELS (pg. 113)	TBEZ-2HCH2, TBEZ-2HCH3, TBEZ-2HCH4, TBEZ-2HCH5



CASE QTY.  
100 PCS



INNER BOX QTY.  
20 PCS



#### WIRING

2 PRONG ADAPTER



Assemble with any standard  
2 Prong Male Wire Harness.

## 2" BEEHIVE - 9 LEDS

### GROMMET MOUNT - MARKER



AMBER MARKER  
**TLED-2BA**



RED MARKER  
**TLED-2BR**

#### TECHNICAL SPECIFICATIONS

DOT/SAE	Compliant
DIODES	9 Diodes
MARKER	TLED-2BA, TLED-2BR
CURRENT DRAW	50 mA
LENS MATERIAL	Polycarbonate
WARRANTY	3 Years

#### ACCESSORY OPTIONS

GROMMETS (pg. 115)	TGRO-2R, TGRO-2RC
WIRE HARNESS (pg. 116-118)	B Series, TPIG-2W
BEZELS (pg. 113)	TBEZ-2CH2, TBEZ-2CH3, TBEZ-2CH4, TBEZ-2CH5



CASE QTY.  
100 PCS



INNER BOX QTY.  
10 PCS

#### WIRING

2 PRONG ADAPTER



Assemble with any standard  
2 Prong Male Wire Harness.

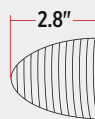

## 2.5" BEEHIVE - 13 LEDS

### GROMMET MOUNT - MARKER



AMBER MARKER  
**TLED-2HBA**



RED MARKER  
**TLED-2HBR**

#### TECHNICAL SPECIFICATIONS

DOT/SAE	Compliant
DIODES	13 Diodes
MARKER	TLED-2HBA, TLED-2HBR
CURRENT DRAW	71 mA
LENS MATERIAL	Polycarbonate
WARRANTY	3 Years

#### ACCESSORY OPTIONS

GROMMETS (pg. 115)	TGRO-2HR, TGRO-2HRO
WIRE HARNESS (pg. 116-118)	B Series, TPIG-2W
BEZELS (pg. 113)	TBEZ-2HCH2, TBEZ-2HCH3, TBEZ-2HCH4, TBEZ-2HCH5



CASE QTY.  
100 PCS



INNER BOX QTY.  
10 PCS

#### WIRING

2 PRONG ADAPTER



Assemble with any standard  
2 Prong Male Wire Harness.

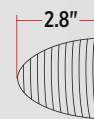

# LED LIGHTING

**TOP  
SELLER**

## GENERATION 4 - 4 LEDS MARKER



▲ **AMBER MARKER  
TLED-G4A**



▲ **CLEAR AMBER MARKER  
TLED-G4CA**



▲ **RED MARKER  
TLED-G4R**



▲ **CLEAR RED MARKER  
TLED-G4CR**

### TECHNICAL SPECIFICATIONS

DOT/SAE	Compliant
DIODES	4 Diodes
MARKER	TLED-G4A, TLED-G4CA, TLED-G4R, TLED-G4CR
CURRENT DRAW	29 mA ~ 30 mA
LENS MATERIAL	Polycarbonate
WARRANTY	3 Years

### ACCESSORY OPTIONS

WIRE HARNESS (pg. 117)	D Series
------------------------	----------



CASE QTY.  
100 PCS



INNER BOX QTY.  
10 PCS

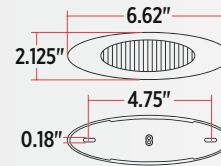

### WIRING

2 BULLET PLUGS



Assemble with any Double Female Wire Harness.

**TOP SELLERS  
GENERATION 4  
MARKER LEDS ARE  
NOW AVAILABLE  
IN A POS BOX**

TRX-238

SEE PAGE 312 FOR MORE INFORMATION



⚠ WARNING: Cancer and Reproductive Harm - [www.p65warnings.ca.gov](http://www.p65warnings.ca.gov)

**TOP  
SELLER**

# GENERATION 2 - 2 LEDS MARKER



**AMBER MARKER  
TLED-G2A**



**CLEAR AMBER MARKER  
TLED-G2CA**



**RED MARKER  
TLED-G2R**



**CLEAR RED MARKER  
TLED-G2CR**

### TECHNICAL SPECIFICATIONS

DOT/SAE	Compliant
DIODES	2 Diodes
MARKER	TLED-G2A, TLED-G2CA, TLED-G2R, TLED-G2CR
CURRENT DRAW	40 mA
LENS MATERIAL	Polycarbonate
WARRANTY	3 Years

### ACCESSORY OPTIONS

WIRE HARNESS (pg. 117)	D Series
------------------------	----------

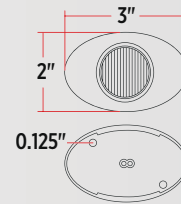
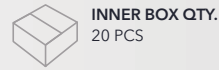

### WIRING

2 BULLET PLUGS

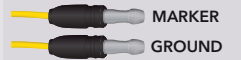

Assemble with any Double Female Wire Harness.



**WARNING:** Cancer and Reproductive Harm - [www.p65warnings.ca.gov](http://www.p65warnings.ca.gov)

# LED LIGHTING

## GENERATION 4 - 10 LEDS MARKER

**NEW**



▲ **AMBER MARKER  
TLED-G4XA**



▲ **CLEAR AMBER MARKER  
TLED-G4XCA**

**NEW**



▲ **RED MARKER  
TLED-G4XR**



▲ **CLEAR RED MARKER  
TLED-G4XCR**

### TECHNICAL SPECIFICATIONS

DOT/SAE	Compliant
DIODES	10 Diodes
MARKER	TLED-G4XCA, TLED-G4XCR, TLED-G4XA, TLED-G4XR
CURRENT DRAW	120 mA
LENS MATERIAL	Polycarbonate
WARRANTY	3 Years

### ACCESSORY OPTIONS

WIRE HARNESS (pg. 117)

D Series



CASE QTY.  
100 PCS



INNER BOX QTY.  
10 PCS

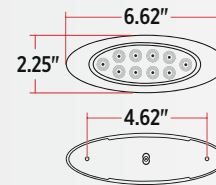

### WIRING

2 BULLET PLUGS



Assemble with any Double Female Wire Harness.



## GENERATION 2 - 4 LEDS MARKER

**NEW**



▲ **AMBER MARKER  
TLED-G2XA**



▲ **CLEAR AMBER MARKER  
TLED-G2XCA**

**NEW**



▲ **RED MARKER  
TLED-G2XR**



▲ **CLEAR RED MARKER  
TLED-G2XCR**

### TECHNICAL SPECIFICATIONS

DOT/SAE	Compliant
DIODES	4 Diodes
MARKER	TLED-G2XCA, TLED-G2XCR, TLED-G2XA, TLED-G2XR
CURRENT DRAW	40 mA
LENS MATERIAL	Polycarbonate
WARRANTY	3 Years

### ACCESSORY OPTIONS

WIRE HARNESS (pg. 117)

D Series



CASE QTY.  
100 PCS



INNER BOX QTY.  
10 PCS

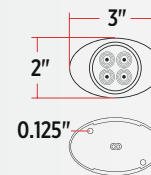

### WIRING

2 BULLET PLUGS



Assemble with any Double Female Wire Harness.

⚠ WARNING: Cancer and Reproductive Harm - www.p65warnings.ca.gov

# FLATLINE GENERATION 4 - 32 LEDS MARKER

[ PATENTED DESIGN ]



▲  
AMBER MARKER  
TLED-FGA



▲  
CLEAR AMBER MARKER  
TLED-FGCA



▲  
RED MARKER  
TLED-FGR



▲  
CLEAR RED MARKER  
TLED-FGCR

## TECHNICAL SPECIFICATIONS

DIODES	32 Diodes
MARKER	TLED-FGA, TLED-FGCA, TLED-FGR, TLED-FGCR
CURRENT DRAW	71 mA ~ 72 mA
LENS MATERIAL	Polycarbonate
WARRANTY	3 Years

## ACCESSORY OPTIONS

WIRE HARNESS (pg. 117)

D Series

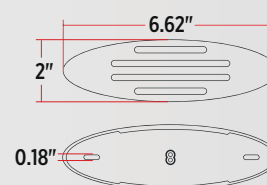
CASE QTY.  
100 PCSINNER BOX QTY.  
20 PCS

## WIRING

2 BULLET PLUGS



Assemble with any Double Female Wire Harness.



# FLATLINE GENERATION 2 - 13 LEDS MARKER



▲  
AMBER MARKER  
TLED-FG2A



▲  
CLEAR AMBER MARKER  
TLED-FG2CA



▲  
RED MARKER  
TLED-FG2R



▲  
CLEAR RED MARKER  
TLED-FG2CR

## TECHNICAL SPECIFICATIONS

DIODES	13 Diodes
MARKER	TLED-FG2A, TLED-FG2CA, TLED-FG2R, TLED-FG2CR
CURRENT DRAW	35 ~ 40 mA
LENS MATERIAL	Polycarbonate
WARRANTY	3 Years

## ACCESSORY OPTIONS

WIRE HARNESS (pg. 117)

D Series

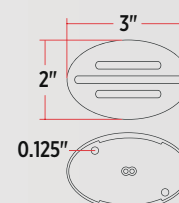
CASE QTY.  
100 PCSINNER BOX QTY.  
20 PCS

## WIRING

2 BULLET PLUGS



Assemble with any Double Female Wire Harness.

⚠ WARNING: Cancer and Reproductive Harm - [www.p65warnings.ca.gov](http://www.p65warnings.ca.gov)

# LED LIGHTING

## WATERMELON - 19 LEDS TURN & MARKER



▲  
AMBER TURN & MARKER  
**TLED-WA**



▲  
CLEAR AMBER TURN & MARKER  
**TLED-WCA**



▲  
RED TURN & MARKER  
**TLED-WR**



▲  
CLEAR RED TURN & MARKER  
**TLED-WCR**

### TECHNICAL SPECIFICATIONS

DOT/SAE	Compliant
DIODES	19 Diodes
TURN & MARKER	TLED-WA, TLED-WCA, TLED-WR, TLED-WCR
CURRENT DRAW	240 mA
LENS MATERIAL	Polycarbonate
WARRANTY	3 Years

### ACCESSORY OPTIONS

WIRE HARNESS (pg. 118)	T-Series
------------------------	----------

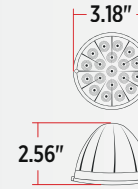
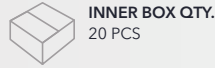

### WIRING

3 BULLET PLUGS

- TURN
- GROUND
- MARKER

Assemble with any Triple Female Wire Harness.



⚠ WARNING: Cancer and Reproductive Harm - [www.p65warnings.ca.gov](http://www.p65warnings.ca.gov)

## PETERBILT CAB - 19 LEDS WITH HOUSING - MARKER



AMBER MARKER  
**TLED-PCAB2**



CLEAR AMBER MARKER  
**TLED-PCABC2**

### TECHNICAL SPECIFICATIONS

DOT/SAE	Compliant
DIODES	19 Diodes
MARKER	TLED-PCAB2, TLED-PCABC2
CURRENT DRAW	60 mA
LENS MATERIAL	Polycarbonate
WARRANTY	3 Years



CASE QTY.  
20 PCS



INNER BOX QTY.  
5 PCS

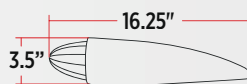

## PETERBILT CAB - 19 LEDS MARKER



AMBER MARKER  
**TLED-PCAB**



CLEAR AMBER MARKER  
**TLED-PCABC**

### TECHNICAL SPECIFICATIONS

DOT/SAE	Compliant
DIODES	19 Diodes
MARKER	TLED-PCAB, TLED-PCABC
CURRENT DRAW	60 mA
LENS MATERIAL	Polycarbonate
WARRANTY	3 Years



CASE QTY.  
50 PCS



INNER BOX QTY.  
10 PCS

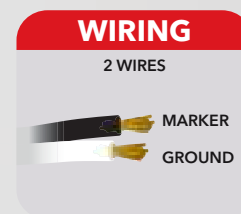

## SQUARE CAB - 42 LEDS WITH HOUSING - MARKER



AMBER MARKER  
**TLED-CAB2**



CLEAR AMBER MARKER  
**TLED-CABC2**

### TECHNICAL SPECIFICATIONS

DOT/SAE	Compliant
DIODES	42 Diodes
MARKER	TLED-CAB2, TLED-CABC2
CURRENT DRAW	146 mA
LENS MATERIAL	Polycarbonate
WARRANTY	3 Years



CASE QTY.  
20 PCS



INNER BOX QTY.  
5 PCS



## SQUARE CAB - 42 LEDS MARKER



AMBER MARKER  
**TLED-CAB**



CLEAR AMBER MARKER  
**TLED-CABC**

### TECHNICAL SPECIFICATIONS

DOT/SAE	Compliant
DIODES	42 Diodes
MARKER	TLED-CAB, TLED-CABC
CURRENT DRAW	146 mA
LENS MATERIAL	Polycarbonate
WARRANTY	3 Years



CASE QTY.  
60 PCS



INNER BOX QTY.  
8 PCS

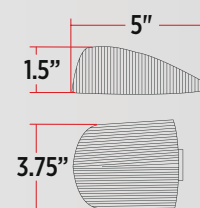
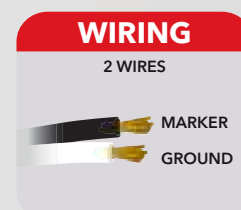

# LED LIGHTING

## INFINITY STANDARD - 13 LEDS MARKER



▲  
**AMBER MARKER  
TLED-INFA**



▲  
**CLEAR AMBER MARKER  
TLED-INFCA**



▲  
**RED MARKER  
TLED-INFR**



▲  
**CLEAR RED MARKER  
TLED-INFCR**

### TECHNICAL SPECIFICATIONS

DOT/SAE	Compliant
DIODES	13 Diodes
MARKER	TLED-INFA, TLED-INFR, TLED-INFCA, TLED-INFCR
CURRENT DRAW	63 mA ~ 64 mA
LENS MATERIAL	Polycarbonate
WARRANTY	3 Years

### ACCESSORY OPTIONS

WIRE HARNESS (pg. 117)	D Series
------------------------	----------

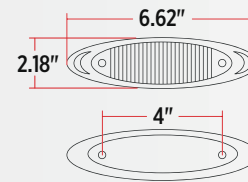
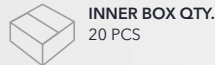

### WIRING

2 BULLET PLUGS



Assemble with any Double Female Wire Harness.



## INFINITY SMALL - 6 LEDS MARKER



▲  
**AMBER MARKER  
TLED-INF2A**



▲  
**CLEAR AMBER MARKER  
TLED-INF2CA**



▲  
**RED MARKER  
TLED-INF2R**



▲  
**CLEAR RED MARKER  
TLED-INF2CR**

### TECHNICAL SPECIFICATIONS

DOT/SAE	Compliant
DIODES	6 Diodes
MARKER	TLED-INF2A, TLED-INF2CA, TLED-INF2R, TLED-INF2CR
CURRENT DRAW	19 mA ~ 26 mA
LENS MATERIAL	Polycarbonate
WARRANTY	3 Years

### ACCESSORY OPTIONS

WIRE HARNESS (pg. 117)	D Series
------------------------	----------

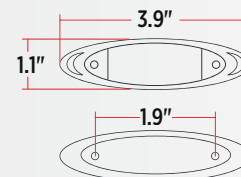
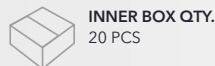

### WIRING

2 BULLET PLUGS



Assemble with any Double Female Wire Harness.

⚠ WARNING: Cancer and Reproductive Harm - [www.p65warnings.ca.gov](http://www.p65warnings.ca.gov)



## 1" X 4" - 12 LEDS MARKER



AMBER MARKER  
TLED-1X4A



RED MARKER  
TLED-1X4R

### TECHNICAL SPECIFICATIONS

DOT/SAE	Compliant
DIODES	12 Diodes
MARKER	TLED-1X4A, TLED-1X4R
CURRENT DRAW	40 mA
LENS MATERIAL	Polycarbonate
WARRANTY	3 Years

### ACCESSORY OPTIONS

WIRE HARNESS	B Series, TPIG-2W (pg. 116, 118)
--------------	-------------------------------------

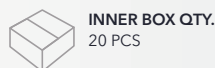

### WIRING

#### 2 PRONG ADAPTER



Assemble with any standard  
2 Prong Male Wire Harness.

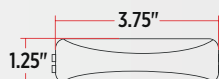

## 1" X 2" - 6 LEDS MARKER



AMBER MARKER  
TLED-1X2A



RED MARKER  
TLED-1X2R

### TECHNICAL SPECIFICATIONS

DOT/SAE	Compliant
DIODES	6 Diodes
MARKER	TLED-1X2A, TLED-1X2R
CURRENT DRAW	39 mA
LENS MATERIAL	Polycarbonate
WARRANTY	3 Years

### ACCESSORY OPTIONS

WIRE HARNESS	B Series, TPIG-2W (pg. 116, 118)
--------------	-------------------------------------



### WIRING

#### 2 PRONG ADAPTER



Assemble with any standard  
2 Prong Male Wire Harness.

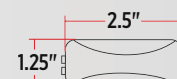

## 2" X 6" - 8 LEDS REFLECTORIZED - MARKER



AMBER MARKER  
TLED-2X6RA



RED MARKER  
TLED-2X6RR

### TECHNICAL SPECIFICATIONS

DOT/SAE	Compliant
DIODES	8 Diodes
MARKER	TLED-2X6RA, TLED-2X6RR
CURRENT DRAW	46 mA
LENS MATERIAL	Polycarbonate
WARRANTY	3 Years

### ACCESSORY OPTIONS

WIRE HARNESS	D Series (pg. 117)
--------------	--------------------

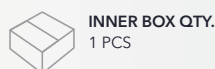

### WIRING

#### 2 BULLET PLUGS



Assemble with any Double  
Female Wire Harness.

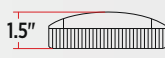

## 2" X 6" - 18 LEDS TURN & MARKER



AMBER TURN & MARKER  
TLED-2X6SA



CLEAR AMBER TURN & MARKER  
TLED-2X6SCA

### TECHNICAL SPECIFICATIONS

DOT/SAE	Compliant
DIODES	18 Diodes
TURN & MARKER	TLED-2X6SA, TLED-2X6SCA
CURRENT DRAW	64 mA
LENS MATERIAL	Polycarbonate
WARRANTY	3 Years

### ACCESSORY OPTIONS

WIRE HARNESS	B612, TPIG-3W (pg. 116-118)
--------------	--------------------------------



### WIRING

#### 3 PRONG ADAPTER



Assemble with any standard  
3 Prong Male Wire Harness.

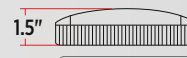
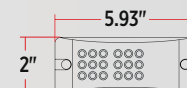

# LED LIGHTING

## 2" X 6" - 20 LEDS MARKER



▲  
**AMBER MARKER**  
**TLED-2X6A**



▲  
**CLEAR AMBER MARKER**  
**TLED-2X6CA**



▲  
**RED MARKER**  
**TLED-2X6R**



▲  
**CLEAR RED MARKER**  
**TLED-2X6CR**

### TECHNICAL SPECIFICATIONS

DOT/SAE	Compliant
DIODES	20 Diodes
MARKER	TLED-2X6A, TLED-2X6R, TLED-2X6CA, TLED-2X6CR
CURRENT DRAW	70 mA ~ 80 mA
LENS MATERIAL	Polycarbonate
WARRANTY	3 Years

### ACCESSORY OPTIONS

WIRE HARNESS (pg. 117)	D Series
------------------------	----------

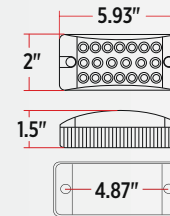
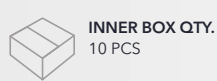

### WIRING

2 BULLET PLUGS



Assemble with any Double Female Wire Harness.

## 2" X 6" - 24 LEDS MULTI-DIRECTIONAL - MARKER



▲  
**AMBER MARKER**  
**TLED-2X6DA**



▲  
**CLEAR AMBER MARKER**  
**TLED-2X6DCA**



▲  
**RED MARKER**  
**TLED-2X6DR**



▲  
**CLEAR RED MARKER**  
**TLED-2X6DCR**

### TECHNICAL SPECIFICATIONS

DOT/SAE	Compliant
DIODES	24 Diodes
MARKER	TLED-2X6DA, TLED-2X6DR, TLED-2X6DCA, TLED-2X6DCR
CURRENT DRAW	56 mA ~ 59 mA
LENS MATERIAL	Polycarbonate
WARRANTY	3 Years

### ACCESSORY OPTIONS

WIRE HARNESS (pg. 117)	D Series
------------------------	----------

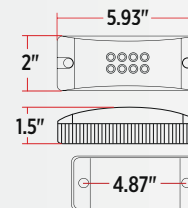
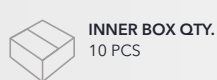

### WIRING

2 BULLET PLUGS



Assemble with any Double Female Wire Harness.



⚠ WARNING: Cancer and Reproductive Harm - [www.p65warnings.ca.gov](http://www.p65warnings.ca.gov)

## DOUBLE BULLSEYE - 16 LEDS MARKER



AMBER MARKER  
**TLED-BA**



RED MARKER  
**TLED-BR**

### TECHNICAL SPECIFICATIONS

DOT/SAE	Compliant
DIODES	16 Diodes
MARKER	TLED-BA, TLED-BR
CURRENT DRAW	50 mA ~ 60 mA
LENS MATERIAL	Polycarbonate
WARRANTY	3 Years

### ACCESSORY OPTIONS

WIRE HARNESS	S Series (pg. 117)
--------------	--------------------



CASE QTY.  
100 PCS



INNER BOX QTY.  
20 PCS

### WIRING

1 BULLET PLUG



Assemble with any Single Female Wire Harness.

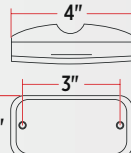

## SQUARE - 32 LEDS GROMMET MOUNT - TURN & MARKER



RED S, T & T  
**TLED-SQR1**

### TECHNICAL SPECIFICATIONS

DOT/SAE	Compliant
DIODES	32 Diodes
STOP, TURN & TAIL	TLED-SQR1
CURRENT DRAW	90 mA
LENS MATERIAL	Polycarbonate
WARRANTY	3 Years

### ACCESSORY OPTIONS

GROMMETS	TGRO-SQR (pg. 115)
WIRE HARNESS	B612, TPIG-3W (pg. 116-118)
BEZELS	TBEZ-SQR (pg. 115)



CASE QTY.  
5 PCS



INNER BOX QTY.  
4 PCS

### WIRING

3 PRONG ADAPTER



Assemble with any standard 3 Prong Male Wire Harness.

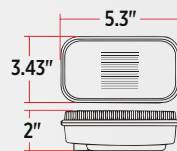

## OVAL HUMP - 18 LEDS GROMMET MOUNT - TURN & MARKER



AMBER TURN & MARKER  
**TLED-HOBA**

### TECHNICAL SPECIFICATIONS

DOT/SAE	Compliant
DIODES	18 Diodes
TURN & MARKER	TLED-HOBA
CURRENT DRAW	130 mA
LENS MATERIAL	Polycarbonate
WARRANTY	3 Years

### ACCESSORY OPTIONS

GROMMETS	TGRO-OBR, TGRO-OBRC (pg. 115)
WIRE HARNESS	B612, TPIG-3W (pg. 116-118)
BEZELS	TBEZ-OLR, TBEZ-OBCH2, TBEZ-OBCH3, TBEZ-OBCH4, TBEZ-OBCH5 (pg. 116)

### WIRING

3 PRONG ADAPTER



Assemble with any standard 3 Prong Male Wire Harness.

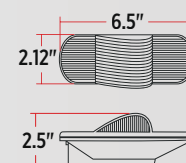

## THIN LINE - 7 LEDS MARKER



RED MARKER  
**TLED-TLA**



RED MARKER  
**TLED-TLR**

### TECHNICAL SPECIFICATIONS

DOT/SAE	Compliant
DIODES	7 Diodes
MARKER	TLED-TLA, TLED-TLR
CURRENT DRAW	39 mA
LENS MATERIAL	Polycarbonate
WARRANTY	3 Years

### ACCESSORY OPTIONS

WIRE HARNESS	D Series (pg. 117)
--------------	--------------------



CASE QTY.  
100 PCS



INNER BOX QTY.  
20 PCS

### WIRING

2 BULLET PLUGS



Assemble with any Double Female Wire Harness.

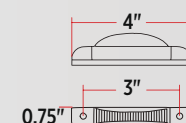

# LED LIGHTING

## PETERBILT SIDE LIGHT FOR HEADLIGHT - 24 LEDS TURN & MARKER



AMBER TURN & MARKER  
**TLED-PSH**



CLEAR AMBER TURN & MARKER  
**TLED-PSHC**

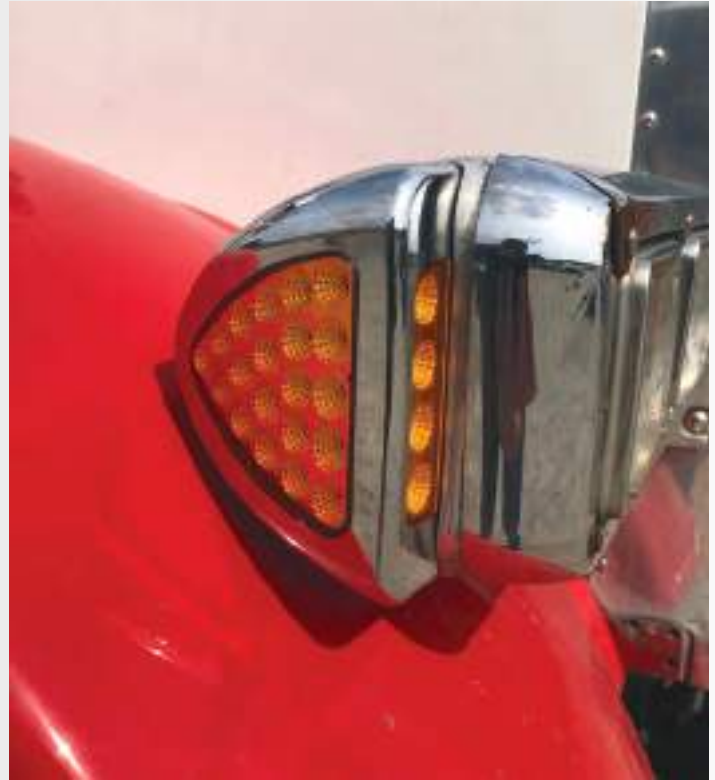

### TECHNICAL SPECIFICATIONS

DIODES	24 Diodes
TURN & MARKER	TLED-PSH, TLED-PSHC
CURRENT DRAW	310 mA
LENS MATERIAL	Polycarbonate
WARRANTY	3 Years



CASE QTY.  
100 PCS



INNER BOX QTY.  
10 PCS

### WIRING

3 WIRES

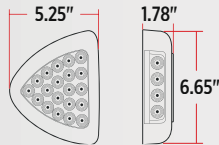

## PETERBILT - 12 LEDS MARKER



AMBER MARKER  
**TLED-PETA**



CLEAR AMBER MARKER  
**TLED-PETCA**



RED MARKER  
**TLED-PETR**

### TECHNICAL SPECIFICATIONS

DOT/SAE	Compliant
DIODES	12 Diodes
MARKER	TLED-PETA, TLED-PETCA, TLED-PETR
CURRENT DRAW	60 mA
LENS MATERIAL	Polycarbonate
WARRANTY	3 Years

### ACCESSORY OPTIONS

WIRE HARNESS (pg. 117)	S Series
------------------------	----------



CASE QTY.  
100 PCS



INNER BOX QTY.  
20 PCS

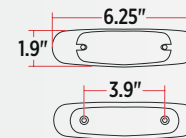

### WIRING

1 BULLET PLUG & TERMINAL



Assemble with any Single Female Wire Harness.

## HEADLIGHT BEZELS - 51 LEDS MARKER



▲  
**CLEAR AMBER MARKER**  
**TU-1029**



▲  
**AMBER MARKER**  
**TU-1029A**



▲  
**WHITE MARKER**  
**TU-1029W**

### TECHNICAL SPECIFICATIONS

DOT/SAE	Compliant
DIODES	51 Diodes
MARKER	TU-1029, TU-1029A, TU-1029W
CURRENT DRAW	550 mA
LENS MATERIAL	Polycarbonate
SOLD	Individually
WARRANTY	3 Years



CASE QTY.  
20 PCS



INNER BOX QTY.  
4 PCS

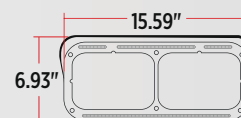

### WIRING

3 WIRES



## MINI FLATLINE - 8 LEDS MARKER



▲  
**AMBER MARKER**  
**TLED-FG3A**



▲  
**CLEAR AMBER MARKER**  
**TLED-FG3CA**



▲  
**RED MARKER**  
**TLED-FG3R**



▲  
**CLEAR RED MARKER**  
**TLED-FG3CR**

### TECHNICAL SPECIFICATIONS

DIODES	8 Diodes
MARKER	TLED-FG3A, TLED-FG3R, TLED-FG3CA, FG3CR
CURRENT DRAW	18 ~ 19 mA
LENS MATERIAL	Polycarbonate
WARRANTY	3 Years

### ACCESSORY OPTIONS

WIRE HARNESS (pg. 117)	D Series
------------------------	----------



CASE QTY.  
100 PCS



INNER BOX QTY.  
20 PCS

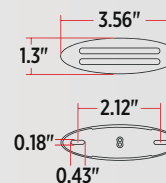

### WIRING

2 BULLET PLUGS & TERMINAL



Assemble with any Double Female Wire Harness.

⚠ WARNING: Cancer and Reproductive Harm - [www.p65warnings.ca.gov](http://www.p65warnings.ca.gov)

# LED LIGHTING

## PETERBILT FENDER - 4 LEDS TURN & MARKER



BACK

AMBER TURN & MARKER  
TLED-PA

## PETERBILT FENDER - 15 LEDS FLATLINE - TURN & MARKER



AMBER TURN & MARKER  
TLED-FPA

CLEAR AMBER TURN & MARKER  
TLED-FPCA

### TECHNICAL SPECIFICATIONS

DOT/SAE	Compliant
DIODES	4 Diodes
TURN & MARKER	TLED-PA
CURRENT DRAW	60 mA
LENS MATERIAL	Polycarbonate
WARRANTY	3 Years

### WIRING

2 WIRES & TERMINAL

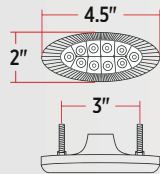
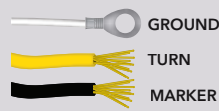

CASE QTY.  
100 PCS

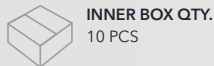

INNER BOX QTY.  
10 PCS

### TECHNICAL SPECIFICATIONS

DIODES	15 Diodes
TURN & MARKER	TLED-FPA, TLED-FPCA
CURRENT DRAW	55 mA
LENS MATERIAL	Polycarbonate
WARRANTY	3 Years

### ACCESSORY OPTIONS

WIRE HARNESS D Series (pg. 117)



CASE QTY.  
100 PCS

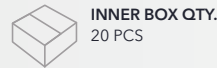

INNER BOX QTY.  
20 PCS

### WIRING

2 BULLETS & TERMINAL



Assemble with any Double Female Wire Harness.

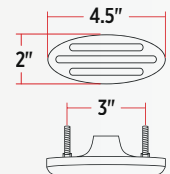

## FTL. CAB LIGHT - 20 LEDS MARKER



AMBER MARKER  
TLED-FTLA

CLEAR AMBER MARKER  
TLED-FTLCA

### TECHNICAL SPECIFICATIONS

DOT/SAE	Compliant
DIODES	20 Diodes
MARKER	TLED-FTLA, TLED-FTLCA
CURRENT DRAW	50 mA
LENS MATERIAL	Polycarbonate
WARRANTY	3 Years

### ACCESSORY OPTIONS

WIRE HARNESS B Series, TPIG-2W (pg. 116-118)

### WIRING

3 PRONG ADAPTER



Assemble with any standard 2 Prong Pigtail.

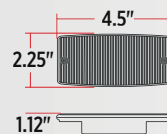

CASE QTY.  
20 PCS

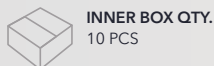

INNER BOX QTY.  
10 PCS

## FTL. SLEEPER LIGHT - 35 LEDS TURN & MARKER



AMBER TURN & MARKER  
TLED-FLCA

CLEAR AMBER TURN & MARKER  
TLED-FLCAC

### TECHNICAL SPECIFICATIONS

DOT/SAE	Compliant
DIODES	35 Diodes
TURN & MARKER	TLED-FLCA, TLED-FLCAC
CURRENT DRAW	130 mA
LENS MATERIAL	Polycarbonate
WARRANTY	3 Years



CASE QTY.  
20 PCS

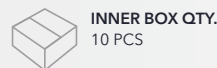

INNER BOX QTY.  
10 PCS

### WIRING

2 WIRES & TERMINAL

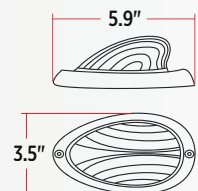

WARNING: Cancer and Reproductive Harm - www.p65warnings.ca.gov



## 8" STAR - 24 LEDs AUXILIARY



▲  
**AMBER AUXILIARY  
TLED-X1A**



▲  
**RED AUXILIARY  
TLED-X1R**



▲  
**BLUE AUXILIARY  
TLED-X1B**



▲  
**GREEN AUXILIARY  
TLED-X1G**

### TECHNICAL SPECIFICATIONS

DIODES	24 Diodes
AUXILIARY	TLED-X1A, TLED-X1R, TLED-X1B, TLED-X1G
CURRENT DRAW	140 mA ~ 150 mA
LENS MATERIAL	Polycarbonate
WARRANTY	3 Years
<b>ACCESSORY OPTIONS</b>	
WIRE HARNESS	D Series (pg. 117)

➤ **ALL 8" Star LEDs are designed to fit  
15" Donaldson & Vortex Air Cleaners**  
Clean surface with water & soap.  
Install Star LED with 3M adhesive (Included).



CASE QTY.  
50 PCS

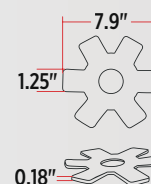

### WIRING

2 BULLET PLUGS



Assemble with any Double  
Female Wire Harness.

## 5" STAR - 24 LEDs AUXILIARY



▲  
**AMBER AUXILIARY  
TLED-X3A**



▲  
**RED AUXILIARY  
TLED-X3R**



▲  
**BLUE AUXILIARY  
TLED-X3B**



▲  
**GREEN AUXILIARY  
TLED-X3G**

### TECHNICAL SPECIFICATIONS

DIODES	24 Diodes
AUXILIARY	TLED-X3A, TLED-X3R, TLED-X3B, TLED-X3G
CURRENT DRAW	140 mA ~ 180 mA
LENS MATERIAL	Polycarbonate
WARRANTY	3 Years
<b>ACCESSORY OPTIONS</b>	
WIRE HARNESS	D Series (pg. 117)

➤ **ALL 5" Star LEDs are designed to fit  
13" Donaldson & Vortex Air Cleaners**  
Clean surface with water & soap.  
Install Star LED with 3M adhesive (Included).

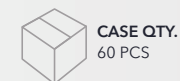

CASE QTY.  
60 PCS

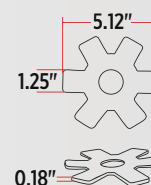

### WIRING

2 BULLET PLUGS



Assemble with any Double  
Female Wire Harness.

⚠ **WARNING: Cancer and Reproductive Harm - [www.p65warnings.ca.gov](http://www.p65warnings.ca.gov)**

# LED LIGHTING

## 17" SLIM - 24 LEDS MARKER



▲ AMBER MARKER  
**TLED-F17A**



▲ CLEAR AMBER MARKER  
**TLED-F17CA**



▲ RED MARKER  
**TLED-F17R**



▲ CLEAR RED MARKER  
**TLED-F17CR**



▲ WHITE MARKER  
**TLED-F17W**

### TECHNICAL SPECIFICATIONS

DIODES	24 Diodes
MARKER	TLED-F17A, TLED-F17CA, TLED-F17R, TLED-F17CR, TLED-F17W
CURRENT DRAW	90 mA
LENS MATERIAL	Polycarbonate
WARRANTY	3 Years

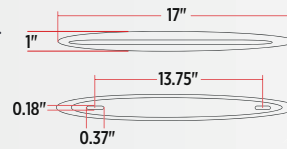
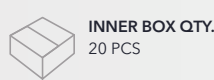

### WIRING

3 WIRES



## 9" SLIM - 14 LEDS MARKER



▲ AMBER MARKER  
**TLED-F9A**



▲ RED MARKER  
**TLED-F9R**



▲ CLEAR AMBER MARKER  
**TLED-F9CA**

### TECHNICAL SPECIFICATIONS

DIODES	14 Diodes
MARKER	TLED-F9A, TLED-F9CA, TLED-F9R
CURRENT DRAW	60 mA
LENS MATERIAL	Polycarbonate
WARRANTY	3 Years

### ACCESSORY OPTIONS

WIRE HARNESS (pg. 117)	D Series
------------------------	----------

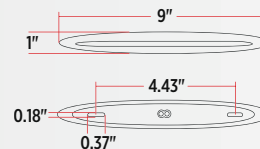

### WIRING

2 BULLET PLUGS & TERMINAL



Assemble with any Double Female Wire Harness.



## 6" SLIM - 9 LEDS MARKER

[ PATENTED DESIGN ]



▲  
AMBER MARKER  
TLED-FG4A



▲  
RED MARKER  
TLED-FG4R



▲  
CLEAR AMBER MARKER  
TLED-FG4CA



▲  
CLEAR RED MARKER  
TLED-FG4CR

### TECHNICAL SPECIFICATIONS

DIODES	9 Diodes
MARKER	TLED- FG4A, TLED-FG4CA, TLED-FG4R, TLED-FG4CR
CURRENT DRAW	31 mA ~ 32 mA
LENS MATERIAL	Polycarbonate
WARRANTY	3 Years

### ACCESSORY OPTIONS

WIRE HARNESS (pg. 117)	D Series
------------------------	----------



CASE QTY.  
100 PCS



INNER BOX QTY.  
20 PCS

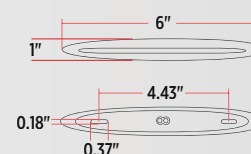

### WIRING

2 BULLET PLUGS &amp; TERMINAL



Assemble with any Double  
Female Wire Harness.



## 4.5" SLIM - 7 LEDS MARKER



▲  
AMBER MARKER  
TLED-F45A



▲  
RED MARKER  
TLED-F45R



▲  
CLEAR AMBER MARKER  
TLED-F45CA

### TECHNICAL SPECIFICATIONS

DIODES	7 Diodes
MARKER	TLED-F45A, TLED-F45CA, TLED-F45R
CURRENT DRAW	20 mA
LENS MATERIAL	Polycarbonate
WARRANTY	3 Years

### ACCESSORY OPTIONS

WIRE HARNESS (pg. 117)	D Series
------------------------	----------



CASE QTY.  
100 PCS



INNER BOX QTY.  
20 PCS

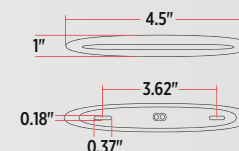

### WIRING

2 BULLET PLUGS &amp; TERMINAL



Assemble with any Double  
Female Wire Harness.

⚠ WARNING: Cancer and Reproductive Harm - [www.p65warnings.ca.gov](http://www.p65warnings.ca.gov)

# LED LIGHTING

## ROUND SUPER VALUE - 42 LEDS DOUBLE FACE - TURN & MARKER



▲  
AMBER/RED TURN & MARKER  
**TLED-DFF**

### TECHNICAL SPECIFICATIONS

DOT/SAE	Compliant
DIODES	42 Diodes
TURN & MARKER	TLED-DFF
CURRENT DRAW	180 mA
LENS MATERIAL	Polycarbonate
WARRANTY	3 Years

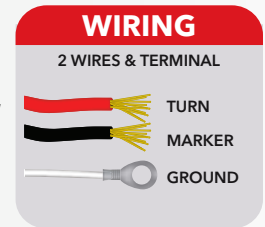
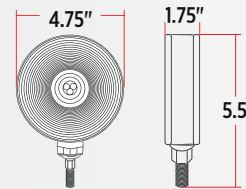
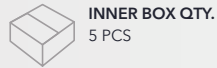

## ROUND SUPER DIODE - 34 LEDS DOUBLE FACE - TURN & MARKER



▲  
AMBER/RED TURN & MARKER  
**TLED-DFC2**



▲  
CLEAR AMBER/RED TURN & MARKER  
**TLED-DFCC2**

### TECHNICAL SPECIFICATIONS

DOT/SAE	Compliant
DIODES	34 Diodes
TURN & MARKER	TLED-DFC2, TLED-DFCC2
CURRENT DRAW	290 mA
LENS MATERIAL	Polycarbonate
WARRANTY	3 Years

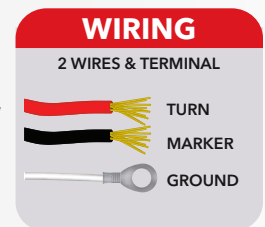
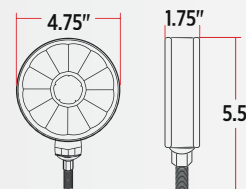
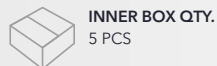

# ROUND CHROME REFLECTOR - 38 LEDS

## DOUBLE FACE - TURN & MARKER



AMBER/RED TURN & MARKER  
**TLED-DFC3**



CLEAR AMBER/RED TURN & MARKER  
**TLED-DFCC3**

### TECHNICAL SPECIFICATIONS

DOT/SAE	Compliant
DIODES	38 Diodes
TURN & MARKER	TLED-DFCC3, TLED-DFC3
CURRENT DRAW	180 mA
LENS MATERIAL	Polycarbonate
WARRANTY	3 Years

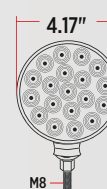
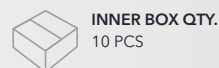

**WIRING**  
2 WIRES & TERMINAL

TURN  
MARKER  
GROUND

# "OL-SKUL" - 38 LEDS

## DOUBLE FACE - TURN & MARKER



AMBER/RED TURN & MARKER  
**TLED-DFO**

### TECHNICAL SPECIFICATIONS

DIODES	38 Diodes
TURN & MARKER	TLED-DFO
CURRENT DRAW	670 mA
LENS MATERIAL	Polycarbonate
WARRANTY	3 Years

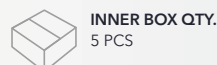

**WIRING**  
2 WIRES & TERMINAL

TURN  
MARKER  
GROUND

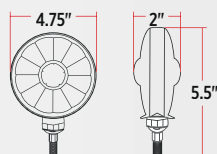

# FLATLINE - 74 LEDS

## DOUBLE FACE - TURN & MARKER



AMBER/RED TURN & MARKER  
**TLED-FD**

CLEAR AMBER/RED  
TURN & MARKER  
**TLED-FDC**

### TECHNICAL SPECIFICATIONS

DIODES	74 Diodes
TURN & MARKER	TLED-FD, TLED-FDC
CURRENT DRAW	200 mA
LENS MATERIAL	Polycarbonate
WARRANTY	3 Years



**WIRING**  
2 WIRES & TERMINAL

TURN  
MARKER  
GROUND

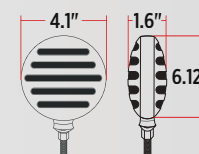

# LED LIGHTING

## SQUARE CHROME REFLECTOR - 38 LEDS DOUBLE FACE - TURN & MARKER

**NEW**



AMBER/RED TURN & MARKER  
**TLED-SDX**



CLEAR AMBER/RED TURN & MARKER  
**TLED-SDXC**

### TECHNICAL SPECIFICATIONS

DOT/SAE	Compliant
DIODES	38 Diodes
TURN & MARKER	TLED-SDXC, TLED-SDX
CURRENT DRAW	180 mA
LENS MATERIAL	Polycarbonate
WARRANTY	3 Years

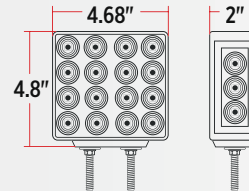
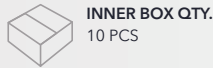

**WIRING**  
2 WIRES & TERMINAL

TURN  
MARKER  
GROUND

## SQUARE FLATLINE - 80 LEDS DOUBLE FACE - TURN & MARKER

FRONT



AMBER/RED TURN & MARKER  
**TLED-FS**

BACK



CLEAR AMBER/RED TURN & MARKER  
**TLED-FSC**

### TECHNICAL SPECIFICATIONS

DIODES	80 Diodes
TURN & MARKER	TLED-FS, TLED-FSC
CURRENT DRAW	156 mA
LENS MATERIAL	Polycarbonate
WARRANTY	3 Years

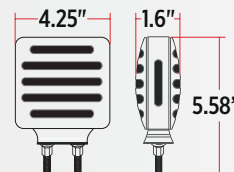
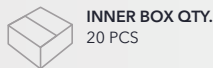

**WIRING**  
2 WIRES & TERMINAL

TURN  
MARKER  
GROUND

WARNING: Cancer and Reproductive Harm - [www.p65warnings.ca.gov](http://www.p65warnings.ca.gov)

# GLOW STRIP LEDS

You've asked and we listened, Trux is proud to announce their new and improved Glow Strip Technology. These powerful LED Glow Strips can be linked to one another and are sold as a center or side glow. It's time to make a statement and be the center of any truck show, creating the illusion that you are under a spotlight. Get yours today to be the star of the show!

## FROSTED CENTER GLOW STRIP LEDS

LINK THE STRIPS TOGETHER! REGARDLESS OF SIZE

### 12 INCH

TLED-GL12CA: **AMBER**  
 TLED-GL12CB: **BLUE**  
 TLED-GL12CG: **GREEN**  
 TLED-GL12CP: **PURPLE**  
 TLED-GL12CR: **RED**  
 TLED-GL12CW: **WHITE**

### 24 INCH

TLED-GL24CA: **AMBER**  
 TLED-GL24CB: **BLUE**  
 TLED-GL24CG: **GREEN**  
 TLED-GL24CP: **PURPLE**  
 TLED-GL24CR: **RED**  
 TLED-GL24CW: **WHITE**

### 48 INCH

TLED-GL48CA: **AMBER**  
 TLED-GL48CB: **BLUE**  
 TLED-GL48CG: **GREEN**  
 TLED-GL48CP: **PURPLE**  
 TLED-GL48CR: **RED**  
 TLED-GL48CW: **WHITE**

LINK THE STRIPS TOGETHER! REGARDLESS OF SIZE

## FROSTED SIDE GLOW STRIP LEDS

### 12 INCH

TLED-GL12SA: **AMBER**  
 TLED-GL12SB: **BLUE**  
 TLED-GL12SG: **GREEN**  
 TLED-GL12SP: **PURPLE**  
 TLED-GL12SR: **RED**  
 TLED-GL12SW: **WHITE**

### 24 INCH

TLED-GL24SA: **AMBER**  
 TLED-GL24SB: **BLUE**  
 TLED-GL24SG: **GREEN**  
 TLED-GL24SP: **PURPLE**  
 TLED-GL24SR: **RED**  
 TLED-GL24SW: **WHITE**

### 48 INCH

TLED-GL48SA: **AMBER**  
 TLED-GL48SB: **BLUE**  
 TLED-GL48SG: **GREEN**  
 TLED-GL48SP: **PURPLE**  
 TLED-GL48SR: **RED**  
 TLED-GL48SW: **WHITE**



SEE PAGES 107-109 FOR MORE INFORMATION

# LED LIGHTING

## 12" CENTER GLOW STRIP - 60 LEDS AUXILIARY



▲ AMBER AUXILIARY  
**TLED-GL12CA**

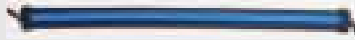

▲ BLUE AUXILIARY  
**TLED-GL12CB**



▲ GREEN AUXILIARY  
**TLED-GL12CG**



▲ PURPLE AUXILIARY  
**TLED-GL12CP**

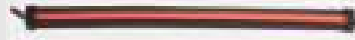

▲ RED AUXILIARY  
**TLED-GL12CR**



▲ WHITE AUXILIARY  
**TLED-GL12CW**

### TECHNICAL SPECIFICATIONS

DIODES	60 Diodes
AUXILIARY	TLED-GL12CA, TLED-GL12CB, TLED-GL12CG, TLED-GL12CP, TLED-GL12CR, TLED-GL12CW
WHAT'S INCLUDED	3M Tape (Double Sided)
CURRENT DRAW	0.11 Amps ~ 0.22 Amps
LENS MATERIAL	Polycarbonate
WARRANTY	3 Years

### ACCESSORY OPTIONS

WIRE HARNESS (pg. 117)	D Series
------------------------	----------

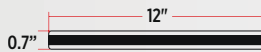

### WIRING

2 BULLET PLUGS



Link Glow Strips together regardless of size.  
Assemble with any Double Female Wire Harness.



## 12" SIDE GLOW STRIP - 60 LEDS AUXILIARY



▲ AMBER AUXILIARY  
**TLED-GL12SA**

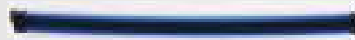

▲ BLUE AUXILIARY  
**TLED-GL12SB**



▲ GREEN AUXILIARY  
**TLED-GL12SG**



▲ PURPLE AUXILIARY  
**TLED-GL12SP**

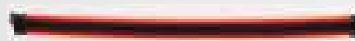

▲ RED AUXILIARY  
**TLED-GL12SR**



▲ WHITE AUXILIARY  
**TLED-GL12SW**

### TECHNICAL SPECIFICATIONS

DIODES	60 Diodes
AUXILIARY	TLED-GL12SA, TLED-GL12SB, TLED-GL12SG, TLED-GL12SP, TLED-GL12SR, TLED-GL12SW
WHAT'S INCLUDED	3M Tape (Double Sided)
CURRENT DRAW	0.1 Amps ~ 0.21 Amps
LENS MATERIAL	Polycarbonate
WARRANTY	3 Years

### ACCESSORY OPTIONS

WIRE HARNESS (pg. 117)	D Series
------------------------	----------

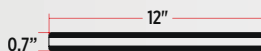

### WIRING

2 BULLET PLUGS



Link Glow Strips together regardless of size.  
Assemble with any Double Female Wire Harness.



## 24" CENTER GLOW STRIP - 120 LEDS AUXILIARY

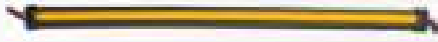

▲ AMBER AUXILIARY  
**TLED-GL24CA**



▲ BLUE AUXILIARY  
**TLED-GL24CB**



▲ GREEN AUXILIARY  
**TLED-GL24CG**



▲ PURPLE AUXILIARY  
**TLED-GL24CP**

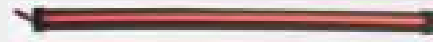

▲ RED AUXILIARY  
**TLED-GL24CR**



▲ WHITE AUXILIARY  
**TLED-GL24CW**

### TECHNICAL SPECIFICATIONS

DIODES	120 Diodes
AUXILIARY	TLED-GL24CA, TLED-GL24CB, TLED-GL24CG, TLED-GL24CP, TLED-GL24CR, TLED-GL24CW
WHAT'S INCLUDED	3M Tape (Double Sided)
CURRENT DRAW	0.94 Amps ~ 0.95 Amps
LENS MATERIAL	Polycarbonate
WARRANTY	3 Years

### ACCESSORY OPTIONS

WIRE HARNESS (pg. 117)	D Series
------------------------	----------

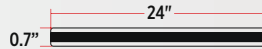

### WIRING

2 BULLET PLUGS



Link Glow Strips together regardless of size.  
Assemble with any Double Female Wire Harness.



## 24" SIDE GLOW STRIP - 120 LEDS AUXILIARY



▲ AMBER AUXILIARY  
**TLED-GL24SA**

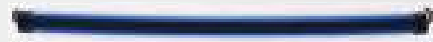

▲ BLUE AUXILIARY  
**TLED-GL24SB**



▲ GREEN AUXILIARY  
**TLED-GL24SG**



▲ PURPLE AUXILIARY  
**TLED-GL24SP**

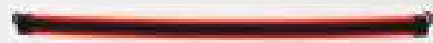

▲ RED AUXILIARY  
**TLED-GL24SR**



▲ WHITE AUXILIARY  
**TLED-GL24SW**

### TECHNICAL SPECIFICATIONS

DIODES	120 Diodes
AUXILIARY	TLED-GL24SA, TLED-GL24SB, TLED-GL24SG, TLED-GL24SP, TLED-GL24SR, TLED-GL24SW
WHAT'S INCLUDED	3M Tape (Double Sided)
CURRENT DRAW	77 Amps ~ 1.07 Amps
LENS MATERIAL	Polycarbonate
WARRANTY	3 Years

### ACCESSORY OPTIONS

WIRE HARNESS (pg. 117)	D Series
------------------------	----------

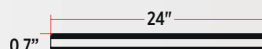

### WIRING

2 BULLET PLUGS



Link Glow Strips together regardless of size.  
Assemble with any Double Female Wire Harness.



# LED LIGHTING

## 48" CENTER GLOW STRIP - 240 LEDS AUXILIARY

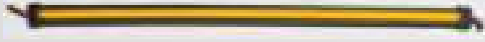

▲ AMBER AUXILIARY  
**TLED-GL48CA**



▲ BLUE AUXILIARY  
**TLED-GL48CB**



▲ GREEN AUXILIARY  
**TLED-GL48CG**



▲ PURPLE AUXILIARY  
**TLED-GL48CP**

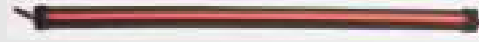

▲ RED AUXILIARY  
**TLED-GL48CR**



▲ WHITE AUXILIARY  
**TLED-GL48CW**

### TECHNICAL SPECIFICATIONS

DIODES	240 Diodes
AUXILIARY	TLED-GL48CA, TLED-GL48CB, TLED-GL48CG, TLED-GL48CP, TLED-GL48CR, TLED-GL48CW
WHAT'S INCLUDED	3M Tape (Double Sided)
CURRENT DRAW	1.29 Amps ~ 1.78 Amps
LENS MATERIAL	Polycarbonate
WARRANTY	3 Years

### ACCESSORY OPTIONS

WIRE HARNESS (pg. 117)	D Series
------------------------	----------



### WIRING

2 BULLET PLUGS



Link Glow Strips together regardless of size.  
Assemble with any Double Female Wire Harness.



## 48" SIDE GLOW STRIP - 240 LEDS AUXILIARY



▲ AMBER AUXILIARY  
**TLED-GL48SA**



▲ BLUE AUXILIARY  
**TLED-GL48SB**



▲ GREEN AUXILIARY  
**TLED-GL48SG**

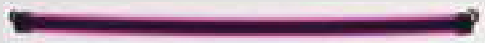

▲ PURPLE AUXILIARY  
**TLED-GL48SP**

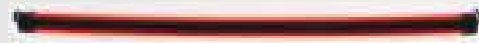

▲ RED AUXILIARY  
**TLED-GL48SR**



▲ WHITE AUXILIARY  
**TLED-GL48SW**

### TECHNICAL SPECIFICATIONS

DIODES	240 Diodes
AUXILIARY	TLED-GL48SA, TLED-GL48SB, TLED-GL48SG, TLED-GL48SP, TLED-GL48SR, TLED-GL48SW
WHAT'S INCLUDED	3M Tape (Double Sided)
CURRENT DRAW	1.06 Amps ~ 1.79 Amps
LENS MATERIAL	Polycarbonate
WARRANTY	3 Years

### ACCESSORY OPTIONS

WIRE HARNESS (pg. 117)	D Series
------------------------	----------



### WIRING

2 BULLET PLUGS



Link Glow Strips together regardless of size.  
Assemble with any Double Female Wire Harness.



⚠ WARNING: Cancer and Reproductive Harm - [www.p65warnings.ca.gov](http://www.p65warnings.ca.gov)



# 0.5 X 17" UNDERMOUNT - 24 LEDS

## AUXILIARY



▲  
AMBER AUXILIARY  
**TLED-SA**





▲  
RED AUXILIARY  
**TLED-SR**

### TECHNICAL SPECIFICATIONS

DIODES	24 Diodes
AUXILIARY	TLED-SA, TLED-SR
WHAT'S INCLUDED	3M Tape (Double Sided)
CURRENT DRAW	13 mA
LENS MATERIAL	Polycarbonate
WARRANTY	3 Years

### ACCESSORY OPTIONS

WIRE HARNESS (pg. 117)	D Series
 CASE QTY. 100 PCS	 <p>0.5" 17"</p>
 INNER BOX QTY. 10 PCS	

INSTALLS WITH 3M TAPE & HARDWARE - INCLUDED

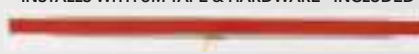

### WIRING

2 BULLET PLUGS



Assemble with any Double Female Wire Harness.

# 16 FT. FLEXIBLE ROLL - 18 LEDS PER FT.

## AUXILIARY



▲  
AMBER AUXILIARY  
**TB-F2A**



▲  
BLUE AUXILIARY  
**TB-F2B**



▲  
GREEN AUXILIARY  
**TB-F2G**



▲  
RED AUXILIARY  
**TB-F2R**



▲  
WHITE AUXILIARY  
**TB-F2W**

### TECHNICAL SPECIFICATIONS

DIODES	18 Diodes per Foot
AUXILIARY	TB-F2A, TB-F2B, TB-F2G, TB-F2R, TB-F2W
OPERATING VOLTAGE	12 Volts
CURRENT DRAW	3 mA
LENS MATERIAL	Polycarbonate
WARRANTY	3 Years

➤ The Flexible Roll is designed for customized use. It can be cut every 3 diodes to your desired length.



# FLEXIBLE ROLL ACCESSORIES



▲  
CLEAR TUBE CLIP WITH DOUBLE SIDED 3M TAPE  
**TB-FCLIP**

### TECHNICAL SPECIFICATIONS

SOLD	Individually
------	--------------



▲  
FLEXIBLE LED ROLL INSTALLATION KIT  
**TB-FKIT**

### TECHNICAL SPECIFICATIONS

WHAT'S INCLUDED	2 End Caps & Duplex Wire Lead
SOLD	Individually

# LED LIGHTING

## 1156 REPLACEMENT BULBS HIGH



▲ AMBER REPLACEMENT  
**TB-S1156A**



▲ RED REPLACEMENT  
**TB-S1156R**



▲ WHITE REPLACEMENT  
**TB-S1156W**

### TECHNICAL SPECIFICATIONS

DIODES	13 Diodes
FUNCTION	High
CURRENT DRAW	50 mA
LENS MATERIAL	Polycarbonate



CASE QTY.  
250 PCS



INNER BOX QTY.  
50 PCS

## 1157 REPLACEMENT BULBS HIGH & LOW



▲ AMBER REPLACEMENT  
**TB-S1157A**



▲ RED REPLACEMENT  
**TB-S1157R**



▲ WHITE REPLACEMENT  
**TB-S1157W**

### TECHNICAL SPECIFICATIONS

DIODES	13 Diodes
FUNCTION	High & Low
CURRENT DRAW	50 mA
LENS MATERIAL	Polycarbonate



CASE QTY.  
250 PCS



INNER BOX QTY.  
50 PCS

## 3156 REPLACEMENT BULBS HIGH



▲ AMBER REPLACEMENT  
**TB-SP3156A**



▲ RED REPLACEMENT  
**TB-SP3156R**



▲ WHITE REPLACEMENT  
**TB-SP3156R**

### TECHNICAL SPECIFICATIONS

DIODES	13 Diodes
FUNCTION	High
CURRENT DRAW	50 mA
LENS MATERIAL	Polycarbonate



CASE QTY.  
250 PCS



INNER BOX QTY.  
50 PCS

## 3157 REPLACEMENT BULBS HIGH & LOW



▲ AMBER REPLACEMENT  
**TB-SP3157A**



▲ RED REPLACEMENT  
**TB-SP3157R**



▲ WHITE REPLACEMENT  
**TB-SP3157W**

### TECHNICAL SPECIFICATIONS

DIODES	13 Diodes
FUNCTION	High & Low
CURRENT DRAW	50 mA
LENS MATERIAL	Polycarbonate



CASE QTY.  
250 PCS



INNER BOX QTY.  
50 PCS

# 194 REPLACEMENT BULBS WITH LENS



▲  
**AMBER REPLACEMENT  
TB-SP3037A**



▲  
**RED REPLACEMENT  
TB-SP3037R**



▲  
**WHITE REPLACEMENT  
TB-SP3037W**



▲  
**BLUE REPLACEMENT  
TB-SP3037B**



▲  
**GREEN REPLACEMENT  
TB-SP3037G**

## TECHNICAL SPECIFICATIONS

DIODES	1 Diode
REPLACEMENT	194 Replacement
CURRENT DRAW	10 mA
LENS MATERIAL	Polycarbonate



CASE QTY.  
500 PCS



INNER BOX QTY.  
100 PCS  
2 PER PACK

## LED STROBE FLASHER 3 PULSE STROBE



▲  
**3 PULSE STROBE  
TU-1007**

## TECHNICAL SPECIFICATIONS

FUNCTION	3 Pulse Strobe
SOLD	Individually
INSTALLATION	Connect the LED Strobe Adapter to your LED Wiring to achieve the Strobe effect.

## UTILITY & LICENSE - 3 LEDS AUXILIARY



▲  
**WHITE AUXILIARY  
TB-C7W**

## TECHNICAL SPECIFICATIONS

DIODES	3 Diodes
FUNCTION	Auxiliary
CURRENT DRAW	38 mA
LENS MATERIAL	Polycarbonate
WARRANTY	3 Years



CASE QTY.  
200 PCS



INNER BOX QTY.  
10 PCS

## WIRING

2 WIRES

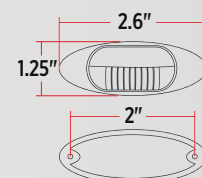

# LIGHTING ACCESSORIES

## LOCK ON ROUND BEZEL

2"



▲  
2" ROUND  
**TBEZ-2CH4**



▲  
2" ROUND WITH VISOR  
**TBEZ-2CH5**

2.5"



▲  
2.5" ROUND  
**TBEZ-2HCH4**



▲  
2.5" ROUND WITH VISOR  
**TBEZ-2HCH5**

4"



▲  
4" ROUND  
**TBEZ-4CH4**



▲  
4" ROUND WITH VISOR  
**TBEZ-4CH5**

### LOCK ON TECHNICAL SPECIFICATIONS

MATERIAL	Chrome ABS Plastic
SOLD	Individually
CASE QUANTITY	200 PCS

## LOCK ON TECHNOLOGY

The 4 special tabs attached behind the bezel, grip under the grommet and lock once you twist adequately.  
**EASY & QUICK INSTALLATION!**



## SCREW ON ROUND BEZEL

2"



▲  
2" ROUND  
**TBEZ-2CH3**



▲  
2" ROUND WITH VISOR  
**TBEZ-2CH2**

2.5"



▲  
2.5" ROUND  
**TBEZ-2HCH3**



▲  
2.5" ROUND WITH VISOR  
**TBEZ-2HCH2**

4"



▲  
4" ROUND  
**TBEZ-4CH3**



▲  
4" ROUND WITH VISOR  
**TBEZ-4CH2**

### SCREW ON TECHNICAL SPECIFICATIONS

MATERIAL	Chrome ABS Plastic
SOLD	Individually
CASE QUANTITY / INNER BOX QUANTITY	100 PCS: TBEZ-4CH2 150 PCS: TBEZ-2HCH2 200 PCS: TBEZ-2CH2, TBEZ-4CH3 400 PCS / 100 PCS: TBEZ-2CH3 500 PCS: TBEZ-2HCH3

**LOCK ON**  
OVAL BEZEL



▲  
OVAL  
**TBEZ-OBCH4**



▲  
OVAL WITH VISOR  
**TBEZ-OBCH5**

**TECHNICAL SPECIFICATIONS**

MATERIAL	Chrome ABS Plastic
SOLD	Individually
CASE QUANTITY	200 PCS

**LOCK ON TECHNOLOGY**

The 4 special tabs attached behind the bezel, grip under the grommet and lock once you twist adequately.

**EASY & QUICK INSTALLATION!**



**SCREW ON**  
OVAL BEZEL



OVAL  
**TBEZ-OBCH3**



▲  
OVAL WITH VISOR  
**TBEZ-OBCH2**

**TECHNICAL SPECIFICATIONS**

MATERIAL	Chrome ABS Plastic
SOLD	Individually
CASE QUANTITY / INNER BOX QUANTITY	100 PCS: TBEZ-OBCH2 200 PCS / 100 PCS: TBEZ-OBCH3

**HEADLIGHT**  
ASSEMBLY BEZEL



▲  
UNIVERSAL HEADLIGHT ASSEMBLY  
**TU-1043**

**TECHNICAL SPECIFICATIONS**

MATERIAL	Chrome ABS Plastic
SOLD	Individually
CASE QUANTITY	20 PCS

**SECURITY LOCK RING**  
ROUND | OVAL



▲  
4" ROUND  
**TBEZ-4LR**



▲  
OVAL  
**TBEZ-OLR**

**TECHNICAL SPECIFICATIONS**

MATERIAL	Chrome ABS Plastic
SOLD	Individually
CASE QUANTITY / INNER BOX QUANTITY	100 PCS/ 20 PCS

# LIGHTING ACCESSORIES

## GROMMETS ROUND

2"



▲  
2" ROUND OPEN BACK  
**TGRO-2R**



▲  
2" ROUND CLOSED BACK  
**TGRO-2RC**

2.5"



▲  
2.5" ROUND OPEN BACK  
**TGRO-2HRO**



▲  
2.5" ROUND CLOSED BACK  
**TGRO-2HR**

4"



▲  
4" ROUND OPEN BACK  
**TGRO-4R**



▲  
4" ROUND CLOSED BACK  
**TGRO-4RC**

### TECHNICAL SPECIFICATIONS

MATERIAL	Rubber
SOLD	Individually
CASE QUANTITY / INNER BOX QUANTITY	100 PCS: TGRO-4R, TGRO-4RC 200 PCS: TGRO-2RC, TGRO-2HR 400 PCS / 50 PCS: TGRO-2R, TGRO-2HRO

## GROMMETS OVAL



▲  
OVAL OPEN BACK  
**TGRO-OBR**



▲  
OVAL CLOSED BACK  
**TGRO-OBRC**

### TECHNICAL SPECIFICATIONS

MATERIAL	Rubber
SOLD	Individually
CASE QUANTITY	200 PCS: TGRO-OBR 100 PCS: TGRO-OBRC

## GROMMETS SQUARE



▲  
SQUARE OPEN BACK  
**TGRO-SQR**

### TECHNICAL SPECIFICATIONS

MATERIAL	Rubber
SOLD	Individually
CASE QUANTITY	50 PC

## SCREW ON SQUARE



▲  
SQUARE WITH VISOR  
**TBEZ-SQR**

### TECHNICAL SPECIFICATIONS

MATERIAL	Chome ABS Plastic
SOLD	Individually
CASE QUANTITY	80 PCS

## THE DIFFERENCE!

Choosing either an Open Back or Closed back grommet is based on the protection and location of your LED light. If you are installing an LED light that is closer to the road surface, then the Closed Back Grommet is the advisable choice, due to its extra protection against all weather elements. The LED wiring can be passed through the hole or slit of the closed back grommet to allow maximum protection of the LED.

▲ WARNING: Cancer and Reproductive Harm - [www.p65warnings.ca.gov](http://www.p65warnings.ca.gov)

## CONVERSION PLUGS 3 PRONG PIGTAIL



▲ SUPERSEAL TO 3 PRONG PIGTAIL  
**TPIG-L1**



▲ LOCK CONNECTOR TO 3 PRONG PIGTAIL  
**TPIG-L2**

**TECHNICAL SPECIFICATIONS**

PART NUMBER	TPIG-L1	TPIG-L2
CONNECTOR TYPE	Super Seal	Lock Connector
FUNCTION	3 Prong Conversion	3 Prong Conversion
SOLD	Individually	Individually

## PIGTAILS INDIVIDUAL WIRE



▲ 2 PRONG  
**TPIG-2W**



▲ 3 PRONG  
**TPIG-3W**

**TECHNICAL SPECIFICATIONS**

PART NUMBER	TPIG-2W	TPIG-3W
CONNECTOR TYPE	2 Prong Male	3 Prong Male
SOLD	Individually	Individually

### 2 OR 3 PRONG?

Always check the connection requirements for the LED Light before purchasing the corresponding Pigtail.

## LOAD RESISTORS LED LIGHTING | LED HEADLIGHTS



▲ 21 WATTS  
**TU-1005**



▲ 80 WATTS  
**TU-1039**

**TECHNICAL SPECIFICATIONS**

PART NUMBER	TU-1005	TU-1039
CURRENT DRAW	21 Watts	80 Watts
COMPATABILITY	LED Lighting	LED Headlights
WHAT'S INCLUDED	N/A	4 Screws
SOLD	Individually	Individually

## H4 CONNECTOR EXTENSION PLUG - LED HEADLIGHTS



▲ H4 HEADLIGHT CONNECTOR EXTENSION PLUG  
**TPIG-H1**

**TECHNICAL SPECIFICATIONS**

CONNECTOR TYPE	H4 (Female)
SOLD	Individually

### THE PURPOSE

Load Resistors are used for trucks that are not LED compatible. Connecting a load resistor will compensate the low power wattage of LEDs.

# LIGHTING ACCESSORIES

## FEMALE WIRE HARNESS Single SERIES



100 FT. SPOOL  
**S608 | S610 | S612**

### TECHNICAL SPECIFICATIONS

PART NUMBER	S608	S610	S612
CONNECTOR TYPE	Single Terminal	Single Terminal	Single Terminal
CONNECTOR SPACING	8" Spacing	10" Spacing	12" Spacing
TOTAL PLUGS	131 Plugs	110 Plugs	92 Plugs
SOLD	100 ft. Spool	100 ft. Spool	100 ft. Spool

### WIRING

Single FEMALE PIGTAIL



## FEMALE WIRE HARNESS DOUBLE SERIES



100 FT. SPOOL  
**D604 | D606 | D608 | D610 | D612**

### TECHNICAL SPECIFICATIONS

PART NUMBER	D604	D606	D608	D610	D612
CONNECTOR TYPE	Double Terminal	Double Terminal	Double Terminal	Double Terminal	Double Terminal
CONNECTOR SPACING	4" Spacing	6" Spacing	8" Spacing	10" Spacing	12" Spacing
TOTAL PLUGS	234 Plugs	168 Plugs	131 Plugs	110 Plugs	92 Plugs
SOLD	100 ft. Spool	100 ft. Spool	100 ft. Spool	100 ft. Spool	100 ft. Spool

### WIRING

DOUBLE FEMALE PIGTAIL



 WARNING: Cancer and Reproductive Harm - [www.p65warnings.ca.gov](http://www.p65warnings.ca.gov)



# FEMALE WIRE HARNESS

## TRIPLE SERIES



100 FT. SPOOL  
**T604 | T606 | T608 | T610 | T612**

**TECHNICAL SPECIFICATIONS**

PART NUMBER	T604	T606	T608	T610	T612
CONNECTOR TYPE	Triple Terminal	Triple Terminal	Triple Terminal	Triple Terminal	Triple Terminal
CONNECTOR SPACING	4" Spacing	6" Spacing	8" Spacing	10" Spacing	12" Spacing
TOTAL PLUGS	220 Plugs	150 Plugs	131 Plugs	110 Plugs	92 Plugs
SOLD	100 ft. Spool	100 ft. Spool	100 ft. Spool	100 ft. Spool	100 ft. Spool

**WIRING**

TRIPLE FEMALE PIGTAIL



# MALE WIRE HARNESS

## 2 PRONG | 3 PRONG



100 FT. SPOOL  
**B607 | B608 | B609 | B610 | B611**



100 FT. SPOOL  
**B612**

**TECHNICAL SPECIFICATIONS**

PART NUMBER	B607	B608	B609	B610	B611	B612
CONNECTOR TYPE	2 Prong Male	2 Prong Male	2 Prong Male	2 Prong Male	2 Prong Male	3 Prong Male
CONNECTOR SPACING	4" Spacing	6" Spacing	8" Spacing	10" Spacing	12" Spacing	12" Spacing
TOTAL PLUGS	234 Plugs	168 Plugs	131 Plugs	110 Plugs	92 Plugs	92 Plugs
SOLD	100 ft. Spool	100 ft. Spool	100 ft. Spool	100 ft. Spool	100 ft. Spool	100 ft. Spool

**WIRING**

2 PRONG MALE PLUG



3 PRONG MALE PLUG



# UNIVERSAL ACCESSORIES

## THREADED WHEEL ACCESSORY KIT DOME HUBCAPS - CHROME ABS PLASTIC

**TOP  
SELLER**



WITH 33MM THREADED NUT COVERS

### THUB-C1

#### TECHNICAL SPECIFICATIONS

KIT INCLUDES	2 x Chrome ABS Plastic Front Axle Covers with Removable Dome Hubcap
	4 x Chrome ABS Plastic Rear Axle Covers with Removable Dome Hubcap
	60 x Chrome ABS Plastic 33mm <b>Threaded</b> Nut Covers
	1 x Nut Cover Tool

## COMPLETE ALL-IN-ONE KIT OUTFITS THE WHOLE TRUCK

#### FEATURES & BENEFITS

- **Threaded Nut Cover Installation**
- **Rust Resistant**
- **Removable** Front and Rear Hubcap to Access Axle
- **Designed to Fit**
  - Most 11 1/4" Bolt Circle/Center Applications
  - Most 20", 22.5" & 24.5" Wheels
  - 3 or 4 Exposed Thread (For Threaded Nut Covers)

BOX DIMENSIONS	27.25" x 15.25" x 14.5"
SOLD	As a Kit
WARRANTY	1 Year



CASE QTY.  
2 PCS

## THREADED WHEEL ACCESSORY KIT POINTED - CHROME ABS PLASTIC



WITH 33MM THREADED POINTED NUT COVERS

### THUB-C4

#### TECHNICAL SPECIFICATIONS

KIT INCLUDES	2 x Chrome ABS Plastic Pointed Front Axle Covers with Removable Pointed Hubcap
	4 x Chrome ABS Plastic Pointed Rear Axle Covers with Removable Pointed Hubcap
	60 x Chrome ABS Plastic Pointed 33mm <b>Threaded</b> Nut Covers
	1 x Nut Cover Tool

## COMPLETE ALL-IN-ONE KIT OUTFITS THE WHOLE TRUCK

#### FEATURES & BENEFITS

- **Threaded Pointed Nut Cover Installation**
- **Rust Resistant**
- **Removable** Front and Rear Hubcap to Access Axle
- **Designed to Fit**
  - Most 11 1/4" Bolt Circle/Center Applications
  - Most 20", 22.5" & 24.5" Wheels
  - 3 or 4 Exposed Thread (For Threaded Nut Covers)

BOX DIMENSIONS	26.5" x 14" x 14"
SOLD	As a Kit
WARRANTY	1 Year



CASE QTY.  
2 PCS

**WARNING:** Cancer and Reproductive Harm - [www.p65warnings.ca.gov](http://www.p65warnings.ca.gov)

# PUSH ON WHEEL ACCESSORY KIT

DOME HUBCAPS - CHROME ABS PLASTIC



## COMPLETE ALL-IN-ONE KIT OUTFITS THE WHOLE TRUCK

**FEATURES & BENEFITS**

- Push On Nut Cover Installation
- Rust Resistant
- Removable Front and Rear Hubcap to Access Axle
- Designed to Fit
  - Most 11 1/4" Bolt Circle/Center Applications
  - Most 20", 22.5" & 24.5" Wheels

WITH 33MM PUSH ON NUT COVERS  
**THUB-C7**

**TECHNICAL SPECIFICATIONS**

<b>KIT INCLUDES</b>	2 x Chrome ABS Plastic Front Axle Covers with Removable Dome Hubcap 4 x Chrome ABS Plastic Rear Axle Covers with Removable Dome Hubcap 60 x Chrome ABS Plastic 33mm <b>Push On</b> Nut Covers
---------------------	---

<b>BOX DIMENSIONS</b>	26.5" x 14" x 14"
<b>SOLD</b>	As a Kit
<b>WARRANTY</b>	1 Year

  
**CASE QTY.**  
2 PCS



 **WARNING:** Cancer and Reproductive Harm - [www.p65warnings.ca.gov](http://www.p65warnings.ca.gov)

# UNIVERSAL ACCESSORIES

## DOME HUB COVER WHEEL ACCESSORY KITS CHROME METAL | STAINLESS STEEL

**TOP  
SELLER**



▲  
CHROME METAL  
**THUB-C2**

### COMPLETE ALL-IN-ONE KIT OUTFITS THE WHOLE TRUCK

- Push On Nut Cover Installation
- Designed to Fit
  - Most 11 1/4" Bolt Circle/Center Applications
  - Most 20", 22.5" & 24.5" Wheels

#### TECHNICAL SPECIFICATIONS

KIT INCLUDES	2 x Chrome Metal 6 Uneven Notch Front Dome Hubcaps (Fits 6, 5 & 4 Notches) 4 x Chrome Metal 8" I.D Rear Hubcaps 60 x Chrome ABS Plastic 33mm Push On Nut Covers
--------------	---

BOX DIMENSIONS	13.75" x 9.8" x 9.8"
SOLD	As a Kit
WARRANTY	1 Year



CASE QTY.  
8 PCS

**TOP  
SELLER**



▲  
STAINLESS STEEL  
**THUB-C3**

### COMPLETE ALL-IN-ONE KIT OUTFITS THE WHOLE TRUCK

- Push On Nut Cover Installation
- Designed to Fit
  - Most 11 1/4" Bolt Circle/Center Applications
  - Most 20", 22.5" & 24.5" Wheels

#### TECHNICAL SPECIFICATIONS

KIT INCLUDES	2 x Stainless Steel 6 Uneven Notch Front Dome Hubcaps (Fits 6, 5 & 4 Notches) 4 x Stainless Steel 8" I.D Rear Hubcaps 60 x Chrome ABS Plastic 33mm Push On Nut Covers
--------------	---

BOX DIMENSIONS	13.75" x 9.8" x 9.8"
SOLD	As a Kit
WARRANTY	1 Year



CASE QTY.  
8 PCS



⚠ WARNING: Cancer and Reproductive Harm - [www.p65warnings.ca.gov](http://www.p65warnings.ca.gov)

# DOMI TRAILER WHEEL ACCESSORY KITS

CHROME METAL | STAINLESS STEEL

**NEW**



CHROME METAL  
**THUB-C5**

## COMPLETE ALL-IN-ONE KIT OUTFITS THE WHOLE TRAILER

- Push On Nut Cover Installation
- Designed to Fit  
Trailers with Hub Pilot Wheels 22.5" or 24"

**TECHNICAL SPECIFICATIONS**

KIT INCLUDES	4 x Chrome Metal Trailer Dome Hubcaps 4 x Stainless Steel Trailer Brackets 40 x Chrome ABS Plastic 33mm Push On Nut Covers
--------------	--

BOX DIMENSIONS	13.75" x 9.8" x 9.8"
SOLD	As a Kit
WARRANTY	1 Year



**NEW**



STAINLESS STEEL  
**THUB-C6**

## COMPLETE ALL-IN-ONE KIT OUTFITS THE WHOLE TRAILER

- Push On Nut Cover Installation
- Designed to Fit  
Trailers with Hub Pilot Wheels 22.5" or 24"

**TECHNICAL SPECIFICATIONS**

KIT INCLUDES	4 x Stainless Steel Trailer Dome Hubcaps 4 x Stainless Steel Trailer Brackets 40 x Chrome ABS Plastic 33mm Push On Nut Covers
--------------	---

BOX DIMENSIONS	13.75" x 9.8" x 9.8"
SOLD	As a Kit
WARRANTY	1 Year



**WARNING:** Cancer and Reproductive Harm - [www.p65warnings.ca.gov](http://www.p65warnings.ca.gov)

# UNIVERSAL ACCESSORIES

## FRONT AXLE COVER KITS DOME HUBCAP - CHROME ABS PLASTIC

**TOP  
SELLER**



WITH 33MM THREADED NUT COVERS

### THUB-FRP33

- Threaded Nut Cover Installation
- Rust Resistant
- Removable Front Hubcap to Access Axle
- Designed to Fit

Most 11 1/4" Bolt Circle/Center Applications  
Most 20", 22.5" & 24.5" Wheels  
3 or 4 Exposed Thread (For Threaded Nut Covers)

#### TECHNICAL SPECIFICATIONS

KIT INCLUDES	1 x Chrome ABS Plastic Front Axle Cover with Removable Dome Hubcap 10 x Chrome ABS Plastic 33mm Threaded Nut Covers
BOX DIMENSIONS	14.25" x 4.25" x 14.25"
SOLD	As a Kit
WARRANTY	1 Year



CASE QTY.  
10 PCS



WITH 33MM PUSH ON NUT COVERS

### THUB-FRP33PO

- Push On Nut Cover Installation
- Rust Resistant
- Removable Front Hubcap to Access Axle
- Designed to Fit

Most 11 1/4" Bolt Circle/Center Applications  
Most 20", 22.5" & 24.5" Wheels

#### TECHNICAL SPECIFICATIONS

KIT INCLUDES	1 x Chrome ABS Plastic Front Axle Cover with Removable Dome Hubcap 10 x Chrome ABS Plastic 33mm Push On Nut Covers
BOX DIMENSIONS	14.25" x 4.25" x 14.25"
SOLD	As a Kit
WARRANTY	1 Year



CASE QTY.  
10 PCS



WARNING: Cancer and Reproductive Harm - [www.p65warnings.ca.gov](http://www.p65warnings.ca.gov)

## FRONT AXLE COVER KITS DOME HUBCAP - CHROME ABS PLASTIC



WITH BLACK 33MM THREADED NUT COVERS

### THUB-FRP33B

- Threaded Nut Cover Installation
- Rust Resistant
- Removable Front Hubcap to Access Axle
- Designed to Fit
  - Most 11 1/4" Bolt Circle/Center Applications
  - Most 20", 22.5" & 24.5" Wheels
  - 3 or 4 Exposed Thread (For Threaded Nut Covers)

#### TECHNICAL SPECIFICATIONS

KIT INCLUDES	1 x Chrome ABS Plastic Black Front Axle Cover with Removable Dome Hubcap 10 x Chrome ABS Plastic Black 33mm Threaded Nut Covers	 CASE QTY. 10 PCS
BOX DIMENSIONS	14.25" x 4.25" x 14.25"	
SOLD	As a Kit	
WARRANTY	1 Year	



WITH 1 1/2" PUSH ON NUT COVERS

### THUB-FRP112

- 1 1/2" Push On Nut Cover Installation
- Rust Resistant
- Removable Front Hubcap to Access Axle
- Designed to Fit
  - Most 11 1/4" Bolt Circle/Center Applications
  - Most 20", 22.5" & 24.5" Wheels

#### TECHNICAL SPECIFICATIONS

KIT INCLUDES	1 x Chrome ABS Plastic Front Axle Cover with Removable Dome Hubcap 10 x Chrome ABS Plastic 1 1/2" Push On Nut Covers 2 x Locking Rings	 CASE QTY. 10 PCS
BOX DIMENSIONS	14.25" x 4.25" x 14.25"	
SOLD	As a Kit	
WARRANTY	1 Year	

## FRONT AXLE ACCESSORIES FRONT AXLE COVER | DOME HUBCAP - CHROME ABS PLASTIC



FRONT AXLE COVER WITH REPLACEMENT DOME HUBCAP  
**THUB-FRPN** Nut Covers NOT Included

- Rust Resistant
- Removable Front Hubcap to Access Axle
- Designed to Fit
  - Most 11 1/4" Bolt Circle/Center Applications
  - Most 20", 22.5" & 24.5" Wheels

#### TECHNICAL SPECIFICATIONS

BOX DIMENSIONS	14" x 4" x 14"	 CASE QTY. 10 PCS
SOLD	Individually	
WARRANTY	1 Year	



FRONT AXLE COVER REPLACEMENT DOME HUBCAP  
**THUB-FRP**

- Rust Resistant
- Designed to Fit
  - Most 11 1/4" Bolt Circle/Center Applications
  - Front Axle Kits: THUB-FRP33, THUB-FRP33PO, THUB-FRP112 & THUB-FRPN

#### TECHNICAL SPECIFICATIONS

SOLD	Individually	 CASE QTY. 80 PCS
WARRANTY	1 Year	

 WARNING: Cancer and Reproductive Harm - www.p65warnings.ca.gov

# UNIVERSAL ACCESSORIES

## POINTED FRONT AXLE COVER KIT CHROME ABS PLASTIC



WITH 33MM THREADED POINTED NUT COVERS  
**THUB-FRP33P**

- Threaded Pointed Nut Cover Installation
- Rust Resistant
- Removable Front Hubcap to Access Axle
- Designed to Fit
  - Most 11 1/4" Bolt Circle/Center Applications
  - Most 20", 22.5" & 24.5" Wheels

### TECHNICAL SPECIFICATIONS

KIT INCLUDES	1 x Chrome ABS Plastic Pointed Front Axle Cover with Removable Pointed Hubcap 10 x Chrome ABS Plastic 33mm Threaded Pointed Nut Covers
BOX DIMENSIONS	14.25" x 4.25" x 14.25"
SOLD	As a Kit
WARRANTY	1 Year



CASE QTY.  
10 PCS

## POINTED FRONT AXLE COVER CHROME ABS PLASTIC



POINTED FRONT AXLE COVER  
**THUB-FRPNP** Nut Covers NOT Included

- Rust Resistant
- Removable Front Hubcap to Access Axle
- Designed to Fit
  - Most 11 1/4" Bolt Circle/Center Applications
  - Most 20", 22.5" & 24.5" Wheels

### TECHNICAL SPECIFICATIONS

KIT INCLUDES	1 x Chrome ABS Plastic Pointed Front Axle Cover with Removable Pointed Hubcap
BOX DIMENSIONS	14.25" x 4.25" x 14.25"
SOLD	Individually
WARRANTY	1 Year



CASE QTY.  
10 PCS



WARNING: Cancer and Reproductive Harm - [www.p65warnings.ca.gov](http://www.p65warnings.ca.gov)



# REAR AXLE COVER KITS

## DOMED HUBCAP - CHROME ABS PLASTIC

**TOP SELLER**



WITH 33MM THREADED NUT COVERS  
**THUB-RP33** Threaded Nut Covers

- Threaded Nut Cover Installation
- Rust Resistant
- Removable Rear Hubcap to Access Axle
- Designed to Fit
  - Most 11 1/4" Bolt Circle/Center Applications
  - Most 20", 22.5" & 24.5" Wheels
  - 3 or 4 Exposed Thread (For Threaded Nut Covers)

**TECHNICAL SPECIFICATIONS**

KIT INCLUDES	1 x Chrome ABS Plastic Rear Axle Cover with Removable Dome Hubcap 10 x Chrome ABS Plastic 33mm Threaded Nut Covers
BOX DIMENSIONS	36" x 14.5" x 15"
SOLD	As a Kit
WARRANTY	1 Year



CASE QTY.  
4 PCS



WITH 33MM PUSH ON NUT COVERS  
**THUB-RP33PO** Push On Nut Covers

- Push On Nut Cover Installation
- Rust Resistant
- Removable Rear Hubcap to Access Axle
- Designed to Fit
  - Most 11 1/4" Bolt Circle/Center Applications
  - Most 20", 22.5" & 24.5" Wheels

**TECHNICAL SPECIFICATIONS**

KIT INCLUDES	1 x Chrome ABS Plastic Rear Axle Cover with Removable Dome Hubcap 10 x Chrome ABS Plastic 33mm Push On Nut Covers
BOX DIMENSIONS	36" x 14.5" x 15"
SOLD	As a Kit
WARRANTY	1 Year



CASE QTY.  
4 PCS



 WARNING: Cancer and Reproductive Harm - [www.p65warnings.ca.gov](http://www.p65warnings.ca.gov)

# UNIVERSAL ACCESSORIES

## REAR AXLE COVER KITS DOME HUBCAP - CHROME ABS PLASTIC



WITH BLACK 33MM THREADED NUT COVERS

### THUB-RP33B

- Threaded Nut Cover Installation
- Rust Resistant
- Removable Rear Hubcap to Access Axle
- Designed to Fit
  - Most 11 1/4" Bolt Circle/Center Applications
  - Most 20", 22.5" & 24.5" Wheels
  - 3 or 4 Exposed Thread (For Threaded Nut Covers)

#### TECHNICAL SPECIFICATIONS

KIT INCLUDES	1 x Chrome ABS Plastic Black Rear Axle Cover with Removable Dome Hubcap 10 x Chrome ABS Plastic Black 33mm Threaded Nut Covers
--------------	---

BOX DIMENSIONS	36" x 14.5" x 15"
SOLD	As a Kit
WARRANTY	1 Year



CASE QTY.  
4 PCS



WITH 1 1/2" PUSH ON NUT COVERS

### THUB-RP112

- 1 1/2" Push On Nut Cover Installation
- Rust Resistant
- Removable Rear Hubcap to Access Axle
- Designed to Fit
  - Most 11 1/4" Bolt Circle/Center Applications
  - Most 20", 22.5" & 24.5" Wheels

#### TECHNICAL SPECIFICATIONS

KIT INCLUDES	1 x Chrome ABS Plastic Rear Axle Cover with Removable Dome Hubcap 10 x Chrome ABS Plastic 1 1/2" Push On Nut Covers 2 x Locking Rings
--------------	---

BOX DIMENSIONS	36" x 14.5" x 15"
SOLD	As a Kit
WARRANTY	1 Year



CASE QTY.  
4 PCS

## REAR AXLE ACCESSORIES REAR AXLE COVER | DOME HUBCAP - CHROME ABS PLASTIC



REAR AXLE COVER WITH REPLACEMENT DOME HUBCAP

### THUB-RPN Nut Covers NOT Included

- Rust Resistant
- Removable Rear Hubcap to Access Axle
- Designed to Fit
  - Most 11 1/4" Bolt Circle/Center Applications
  - Most 20", 22.5" & 24.5" Wheels

#### TECHNICAL SPECIFICATIONS

BOX DIMENSIONS	14" x 8.5" x 14"
SOLD	Individually
WARRANTY	1 Year



CASE QTY.  
4 PCS



REAR AXLE COVER REPLACEMENT DOME HUBCAP

### THUB-RP

- Rust Resistant
- Designed to Fit
  - Most 11 1/4" Bolt Circle/Center Applications
  - Rear Axle Kits: THUB-RP33, THUB-RP33PO, THUB-RP112 & THUB-RPN

#### TECHNICAL SPECIFICATIONS

SOLD	Individually
WARRANTY	1 Year



CASE QTY.  
100 PCS

⚠ WARNING: Cancer and Reproductive Harm - www.p65warnings.ca.gov

## POINTED REAR AXLE COVER KIT CHROME ABS PLASTIC



WITH 33MM THREADED POINTED NUT COVERS  
**THUB-RP33P**

- Threaded Pointed Nut Cover Installation
- Rust Resistant
- Removable Rear Hubcap to Access Axle
- Designed to Fit
  - Most 11 1/4" Bolt Circle/Center Applications
  - Most 20", 22.5" & 24.5" Wheels

### TECHNICAL SPECIFICATIONS

KIT INCLUDES	1 x Chrome ABS Plastic Pointed Rear Axle Cover with Removable Pointed Hubcap 10 x Chrome ABS Plastic 33mm Threaded Pointed Nut Covers
BOX DIMENSIONS	36" x 14.5" x 15"
SOLD	As a Kit
WARRANTY	1 Year



CASE QTY.  
4 PCS

## POINTED REAR AXLE COVER CHROME ABS PLASTIC



REAR AXLE COVER WITH REPLACEMENT POINTED HUBCAP  
**THUB-RPNP** Nut Covers NOT Included

- Rust Resistant
- Removable Rear Hubcap to Access Axle
- Designed to Fit
  - Most 11 1/4" Bolt Circle/Center Applications
  - Most 20", 22.5" & 24.5" Wheels

### TECHNICAL SPECIFICATIONS

KIT INCLUDES	1 x Chrome ABS Plastic Pointed Rear Axle Cover with Removable Pointed Hubcap
BOX DIMENSIONS	14" x 8.5" x 14"
SOLD	Individually
WARRANTY	1 Year



CASE QTY.  
4 PCS



# UNIVERSAL ACCESSORIES

## NUT COVER KITS CHROME ABS PLASTIC

**TOP  
SELLER**



33MM WITH FLANGE  
**TNUT-C1** Push On Nut Covers

**BOX OF 60 NUT COVERS  
OUTFITS THE WHOLE TRUCK**

- Push On Nut Cover Installation
- Designed to Fit  
33mm Lug Nuts

### TECHNICAL SPECIFICATIONS

NUT COVER HEIGHT	2.5"
BOX DIMENSIONS	12.6" x 10.63" x 5.63"
SOLD	Box of 60
WARRANTY	1 Year



CASE QTY.  
4 PCS



33MM WITH FLANGE  
**TNUT-C4** Threaded Nut Covers

**BOX OF 60 NUT COVERS  
OUTFITS THE WHOLE TRUCK**

- Threaded Pointed Nut Cover Installation
- Designed to Fit  
33mm Lug Nuts with 3 or 4 Exposed Thread (For Threaded Nut Covers)

### TECHNICAL SPECIFICATIONS

NUT COVER HEIGHT	5"
BOX DIMENSIONS	12.6" x 10.63" x 5.63"
SOLD	Box of 60
WARRANTY	1 Year



CASE QTY.  
4 PCS

## PUSH ON NUT COVERS CHROME ABS PLASTIC

**TOP  
SELLER**



33MM WITH FLANGE  
**TNUT-F2**

### TECHNICAL SPECIFICATIONS

NUT COVER HEIGHT	2.5"
SOLD	Individually
WARRANTY	1 Year

CASE QTY.  
500 PCS



33MM  
**TNUT-F2L**

### TECHNICAL SPECIFICATIONS

NUT COVER HEIGHT	4"
SOLD	Individually
WARRANTY	1 Year

CASE QTY.  
120 PCS



1 1/2"  
**TNUT-B2**

### TECHNICAL SPECIFICATIONS

NUT COVER HEIGHT	3"
SOLD	Individually
WARRANTY	1 Year

CASE QTY.  
500 PCS



33MM WITH FLANGE  
**TNUT-F2TP**

### TECHNICAL SPECIFICATIONS

NUT COVER HEIGHT	3"
SOLD	Individually
WARRANTY	1 Year

CASE QTY.  
500 PCS

⚠ WARNING: Cancer and Reproductive Harm - [www.p65warnings.ca.gov](http://www.p65warnings.ca.gov)

# PUSH ON NUT COVERS

CHROME METAL | STAINLESS STEEL



33MM CHROME METAL  
**TNUT-B1**

**TECHNICAL SPECIFICATIONS**

NUT COVER HEIGHT	2"
SOLD	Individually
WARRANTY	1 Year



33MM CHROME METAL WITH FLANGE  
**TNUT-F1**

**TECHNICAL SPECIFICATIONS**

NUT COVER HEIGHT	2"
SOLD	Individually
WARRANTY	1 Year



33MM STAINLESS STEEL WITH FLANGE  
**TNUT-F1SS**

**TECHNICAL SPECIFICATIONS**

NUT COVER HEIGHT	2"
SOLD	Individually
WARRANTY	1 Year



# THREADED NUT COVERS

CHROME ABS PLASTIC



33MM WITH FLANGE  
**TNUT-F2T**

**TECHNICAL SPECIFICATIONS**

NUT COVER HEIGHT	3"
SOLD	Individually
WARRANTY	1 Year



BLACK 33MM WITH FLANGE  
**TNUT-F2TB**

**TECHNICAL SPECIFICATIONS**

NUT COVER HEIGHT	3"
SOLD	Individually
WARRANTY	1 Year



33MM WITH FLANGE  
**TNUT-F2TL**

**TECHNICAL SPECIFICATIONS**

NUT COVER HEIGHT	4"
SOLD	Individually
WARRANTY	1 Year



33MM WITH FLANGE  
**TNUT-P1**

**TECHNICAL SPECIFICATIONS**

NUT COVER HEIGHT	5"
SOLD	Individually
WARRANTY	1 Year



# LUG NUT TOOLS



1 1/2" & 33MM (PUSH ON) LUG NUT PULLER  
**TU-1033**

**TECHNICAL SPECIFICATIONS**

DESIGNED FOR	33mm & 1 1/2" Lug Nuts
MATERIAL	Vinyl & Metal
SOLD	Individually



33MM THREADED LUG NUT COVER WENCH  
**TU-1037**

**TECHNICAL SPECIFICATIONS**

DESIGNED FOR	33mm Threaded Lug Nuts
MATERIAL	Plastic
SOLD	Individually

⚠️ WARNING: Cancer and Reproductive Harm - www.p65warnings.ca.gov

# UNIVERSAL ACCESSORIES

## 6 UNEVEN NOTCH FRONT HUBCAPS CHROME METAL | STAINLESS STEEL



▲  
CHROME METAL DOME  
**THUB-6N**



▲  
CHROME METAL POINTED  
**THUB-6NP**



▲  
STAINLESS STEEL DOME  
**THUB-6NSS**

### TECHNICAL SPECIFICATIONS

LIP SIZE	7/16" Lip
WHAT'S INCLUDED	6 Uneven Notches & Clips
SOLD	Individually
WARRANTY	1 Year

### DESIGNED TO FIT

4,5 and 6 Notch Piloted Wheels Only  
Compatible with Stud or Hub Piloted Wheels  
For 20", 22.5" & 24.5" Steel Wheels  
Oil Axles Only



CASE QTY.  
50 PCS

## 5 NOTCH FRONT HUBCAPS CHROME METAL | STAINLESS STEEL



▲  
CHROME METAL DOME  
**THUB-5N**



▲  
CHROME METAL POINTED  
**THUB-5NP**



▲  
STAINLESS STEEL DOME  
**THUB-5NSS**

### TECHNICAL SPECIFICATIONS

LIP SIZE	7/16" Lip
WHAT'S INCLUDED	5 Notches & Clips
SOLD	Individually
WARRANTY	1 Year

### DESIGNED TO FIT

5 Notch Piloted Wheels Only  
Compatible with Stud or Hub Piloted Wheels  
For 20", 22.5" & 24.5" Steel Wheels  
Oil Axles Only



CASE QTY.  
50 PCS

## 4 NOTCH FRONT HUBCAPS CHROME METAL | STAINLESS STEEL



▲  
CHROME METAL DOME  
**THUB-4N**



▲  
CHROME METAL POINTED  
**THUB-4NP**



▲  
STAINLESS STEEL DOME  
**THUB-4NSS**

### TECHNICAL SPECIFICATIONS

LIP SIZE	7/16" Lip
WHAT'S INCLUDED	4 Notches & Clips
SOLD	Individually
WARRANTY	1 Year

### DESIGNED TO FIT

4 Notch Piloted Wheels Only  
Compatible with Stud or Hub Piloted Wheels  
For 20", 22.5" & 24.5" Steel Wheels  
Oil Axles Only



CASE QTY.  
50 PCS

⚠ WARNING: Cancer and Reproductive Harm - [www.p65warnings.ca.gov](http://www.p65warnings.ca.gov)

# 8" I.D REAR HUBCAPS

CHROME METAL | STAINLESS STEEL

**TOP SELLER**



▲ CHROME METAL DOME  
**THUB-858**



▲ STAINLESS STEEL DOME  
**THUB-858SS**



▲ CHROME METAL POINTED  
**THUB-858P**

**TECHNICAL SPECIFICATIONS**

LIP SIZE	1" Lip
SOLD	Individually
WARRANTY	1 Year

DESIGNED TO FIT	8 1/4" Diameter Rear Axles with 8 x 5/8" Studs Compatible with Hub Piloted Wheels Most Peterbilt, Kenworth & Freightliner Trucks
-----------------	--



For Axle Housing Nuts that take a 24mm socket an 8" Hubcap is required.

# 8 1/4" I.D REAR HUBCAPS

CHROME METAL | STAINLESS STEEL



▲ CHROME METAL DOME  
**THUB-834**



▲ CHROME METAL POINTED  
**THUB-834P**



▲ STAINLESS STEEL DOME  
**THUB-834SS**



▲ STAINLESS STEEL DOME  
INTERNATIONAL 2003+ MODELS  
**THUB-834SS2003**

**TECHNICAL SPECIFICATIONS**

LIP SIZE	1" Lip THUB-833SS2003: 1 1/2" Lip
SOLD	Individually
WARRANTY	1 Year

DESIGNED TO FIT	8 1/2" Diameter Rear Axles with 8 x 3/4" Studs Compatible with Hub Piloted Wheels Most International, Volvo & some Mack Trucks
-----------------	--



For Axle Housing Nuts that take a 28mm socket an 8 1/4" Hubcap is required.

# 7 1/4" I.D REAR HUBCAP

CHROME METAL



▲ CHROME METAL DOME  
**THUB-712**

**TECHNICAL SPECIFICATIONS**

LIP SIZE	1" Lip
SOLD	Individually
WARRANTY	1 Year

DESIGNED TO FIT	7 1/2" Diameter Rear Axles with 12 x 1/2" Studs Compatible with Hub Piloted Wheels Oil Axles Only
-----------------	---



# UNIVERSAL ACCESSORIES



- 430 Mirror Shine Stainless Steel
- 18 Gauge Flat Top Design
- Spring Loaded
- LED Lighting with Grommets & Bezels\*
- Locking Nuts Included
- Pre-Wired & Assembled Kits\*

\*Applies to Specific Products



**SOLD IN**  
RETAIL PACKAGING

## 30" MUD FLAP HANGERS - 3 3/4" BOLT SPACING

STANDARD LEDS - STAINLESS STEEL - FLAT TOP



▲ 6 x 4" HOLES  
**TU-9209**

**TOP  
SELLER**



▲ RED STOP, TURN & TAIL  
**TU-9209L1** Red Lens



▲ RED STOP, TURN & TAIL  
**TU-9209LC** Clear Lens

### TECHNICAL SPECIFICATIONS

BOLT SPACING	3 3/4"
DOT/SAE	Compliant
FUNCTION	Stop, Turn & Tail
WARRANTY	1 Year

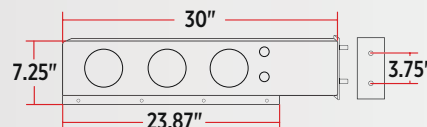

TU-9209LC OFF



Attach to the chassis using a hand wrench and supplied hardware. Warranty VOID if power tools are used for the installation.

PART NUMBER	TU-9209	TU-9209L1	TU-9209LC
KIT INCLUDES	2 x Mud Flap Hangers with 4" Holes	2 x Mud Flap Hangers 6 x TLED-48R 6 x TBEZ-4CH4 6 x TGRO-4R	2 x Mud Flap Hangers 6 x TLED-48CR 6 x TBEZ-4CH4 6 x TGRO-4R

⚠ WARNING: Cancer and Reproductive Harm - [www.p65warnings.ca.gov](http://www.p65warnings.ca.gov)





# 30" MUD FLAP HANGERS - 3 3/4" BOLT SPACING

DUAL REVOLUTION LEDS - STAINLESS STEEL - FLAT TOP

**TOP  
SELLER**



RED STOP, TURN & TAIL TO **WHITE** BACK UP  
**TU-9209L2** Clear Lens

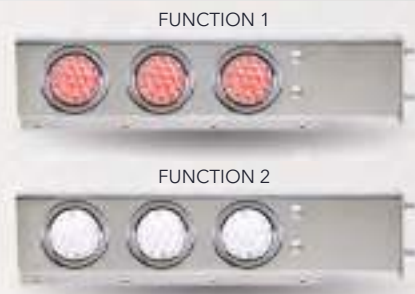

RED STOP, TURN & TAIL TO **WHITE** BACK UP  
**TU-9209L3** Clear Lens

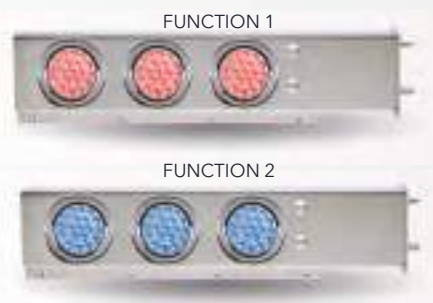

RED STOP, TURN & TAIL TO **BLUE** AUXILIARY  
**TU-9209L4** Clear Lens

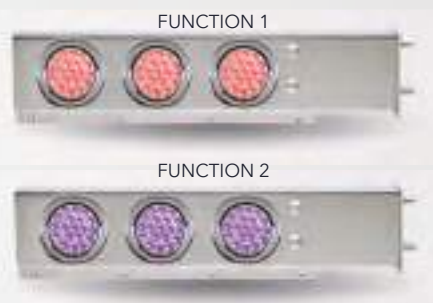

RED STOP, TURN & TAIL TO **PURPLE** AUXILIARY  
**TU-9209L5** Clear Lens



RED STOP, TURN & TAIL TO **GREEN** AUXILIARY  
**TU-9209L6** Clear Lens

**TECHNICAL SPECIFICATIONS**

BOLT SPACING	3 3/4"
DOT/SAE	DOT to Auxiliary
FUNCTIONS	Stop, Turn & Tail to Auxiliary
WARRANTY	1 Year

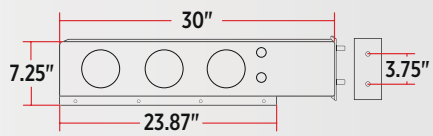

Attach to the chassis using a hand wrench and supplied hardware. Warranty VOID if power tools are used for the installation.

PART NUMBER	TU-9209L2	TU-9209L3	TU-9209L4	TU-9209L5	TU-9209L6
KIT INCLUDES	2 x Mud Flap Hangers 4 x TLED-4X40 2 x TLED-419CR 6 x TBEZ-4CH4 6 x TGRO-4R	2 x Mud Flap Hangers 6 x TLED-4X40 6 x TBEZ-4CH4 6 x TGRO-4R	2 x Mud Flap Hangers 6 x TLED-4XRB 6 x TBEZ-4CH4 6 x TGRO-4R	2 x Mud Flap Hangers 6 x TLED-4XRP 6 x TBEZ-4CH4 6 x TGRO-4R	2 x Mud Flap Hangers 6 x TLED-4XRG 6 x TBEZ-4CH4 6 x TGRO-4R

**WARNING:** Cancer and Reproductive Harm - [www.p65warnings.ca.gov](http://www.p65warnings.ca.gov)

# UNIVERSAL ACCESSORIES



- 430 Mirror Shine Stainless Steel
- 18 Gauge Flat Top Design
- Spring Loaded
- LED Lighting with Grommets & Bezels\*
- Locking Nuts Included
- Pre-Wired & Assembled Kits\*

\*Applies to Specific Products



**SOLD IN**  
RETAIL PACKAGING

## 30" MUD FLAP HANGERS - 2 1/2" BOLT SPACING

STANDARD LEDS - STAINLESS STEEL - FLAT TOP



▲ 6 x 4" HOLES  
**TU-9210**

### TECHNICAL SPECIFICATIONS

BOLT SPACING	2 1/2"
DOT/SAE	Compliant
FUNCTION	Stop, Turn & Tail
WARRANTY	1 Year

**TOP  
SELLER**



▲ RED STOP, TURN & TAIL  
**TU-9210L1** Red Lens



▲ RED STOP, TURN & TAIL  
**TU-9210LC** Clear Lens

TU-9210LC OFF



Attach to the chassis using a hand wrench and supplied hardware. Warranty VOID if power tools are used for the installation.

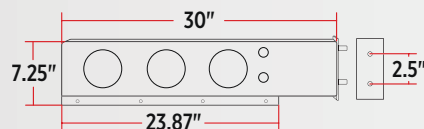

PART NUMBER	TU-9210	TU-9210L1	TU-9210LC
KIT INCLUDES	2 x Mud Flap Hangers with 4" Holes	2 x Mud Flap Hangers 6 x TLED-48R 6 x TBEZ-4CH4 6 x TGRO-4R	2 x Mud Flap Hangers 6 x TLED-48CR 6 x TBEZ-4CH4 6 x TGRO-4R

⚠ WARNING: Cancer and Reproductive Harm - [www.p65warnings.ca.gov](http://www.p65warnings.ca.gov)



**30" LED MUD FLAP HANGERS - 2 1/2" BOLT SPACING**  
 DUAL REVOLUTION LEDS - STAINLESS STEEL - FLAT TOP

**TOP  
SELLER**



RED STOP, TURN & TAIL TO **WHITE** BACK UP  
**TU-9210L2** Clear Lens



RED STOP, TURN & TAIL TO **WHITE** BACK UP  
**TU-9210L3** Clear Lens

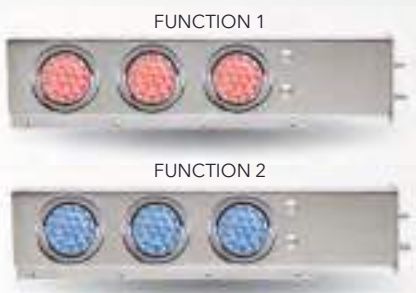

RED STOP, TURN & TAIL TO **BLUE** AUXILIARY  
**TU-9210L4** Clear Lens

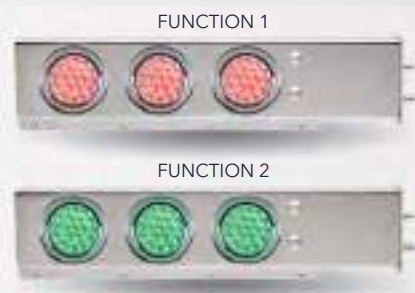

RED STOP, TURN & TAIL TO **GREEN** AUXILIARY  
**TU-9210L5** Clear Lens



RED STOP, TURN & TAIL TO **PURPLE** AUXILIARY  
**TU-9210L6** Clear Lens

**TECHNICAL SPECIFICATIONS**

BOLT SPACING	2 1/2"
DOT/SAE	DOT to Auxiliary
FUNCTIONS	Stop, Turn & Tail to Auxiliary
WARRANTY	1 Year

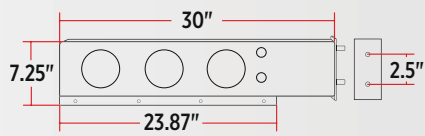

Attach to the chassis using a hand wrench and supplied hardware. Warranty VOID if power tools are used for the installation.

PART NUMBER	TU-9210L2	TU-9210L3	TU-9210L4	TU-9210L5	TU-9210L6
KIT INCLUDES	2 x Mud Flap Hangers 4 x TLED-4X40 2 x TLED-419CR 6 x TBEZ-4CH4 6 x TGRO-4R	2 x Mud Flap Hangers 6 x TLED-4X40 6 x TBEZ-4CH4 6 x TGRO-4R	2 x Mud Flap Hangers 6 x TLED-4XRB 6 x TBEZ-4CH4 6 x TGRO-4R	2 x Mud Flap Hangers 6 x TLED-4XRG 6 x TBEZ-4CH4 6 x TGRO-4R	2 x Mud Flap Hangers 6 x TLED-4XRP 6 x TBEZ-4CH4 6 x TGRO-4R

**WARNING:** Cancer and Reproductive Harm - [www.p65warnings.ca.gov](http://www.p65warnings.ca.gov)

# UNIVERSAL ACCESSORIES

## 30" OVAL LED MUD FLAP HANGERS - 3 3/4" BOLT SPACING SPRING LOADED - STAINLESS STEEL



6 x OVAL HOLES  
**TU-9217**



RED STOP, TURN & TAIL  
**TU-9217L Red Lens**



RED STOP, TURN & TAIL  
**TU-9217LC Clear Lens**

### TECHNICAL SPECIFICATIONS

BOLT SPACING	3 3/4"
DOT/SAE	Compliant
FUNCTION	Stop, Turn & Tail
WARRANTY	1 Year

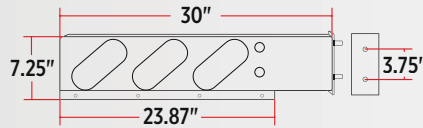

TU-9217LC OFF

Attach to the chassis using a hand wrench and supplied hardware. Warranty VOID if power tools are used for the installation.

PART NUMBER	TU-9217	TU-9217L	TU-9217LC
KIT INCLUDES	2 x Mud Flap Hangers with 6" Oval Holes	2 x Mud Flap Hangers 6 x TLED-OBMR 6 x TBEZ-OBCH4 6 x TGRO-OBR	2 x Mud Flap Hangers 6 x TLED-OBMCR 6 x TBEZ-OBCH4 6 x TGRO-OBR

## 33" MUD FLAP HANGERS - 2 1/2" BOLT SPACING SPRING LOADED - STAINLESS STEEL



6 x 4" HOLES  
**TU-9258**



NO LEDs  
**TU-9259**

### TECHNICAL SPECIFICATIONS

BOLT SPACING	2 1/2"
WHAT'S INCLUDED	Locking Nuts
SOLD	As a Pair
WARRANTY	1 Year

TU-9258

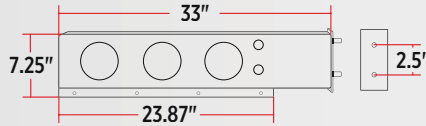

TU-9259

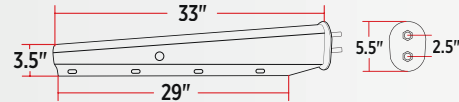

Attach to the chassis using a hand wrench and supplied hardware. Warranty VOID if power tools are used for the installation.

# TOP FLAP LIGHT BARS

## STAINLESS STEEL



NO LEDs  
**TU-9245**



RED MARKER  
**TU-9245LF** Red Lens



RED MARKER  
**TU-9245LFC** Clear Lens



WHITE MARKER  
**TU-9245LFC2** White Lens

**TECHNICAL SPECIFICATIONS**

DESIGNED TO FIT	30" Top Mud Flap Hangers
FUNCTION	Marker
SOLD	As a Pair
WARRANTY	1 Year

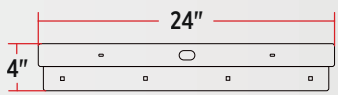

# REFLECTOR STRIPS

## ALUMINUM



STRAIGHT  
**TU-9249**



ANGLED  
**TU-9250**

**TECHNICAL SPECIFICATIONS**

DESIGNED TO FIT	Straight & Angled Mud Flap Hangers
WHAT'S INCLUDED	3M Tape
SOLD	As a Pair

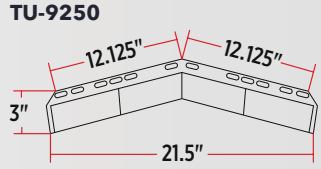

# REPLACEMENT SPRINGS

## STEEL



6" Spring Length  
**TU-9248**



10 5/8" Spring Length  
**TU-9230**



14 1/8" Spring Length  
**TU-9231**

**TECHNICAL SPECIFICATIONS**

DESIGNED TO FIT	Most Makes & Models
SOLD	Individually

Professional Installation Recommended

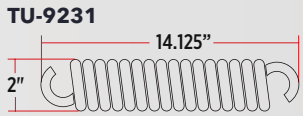
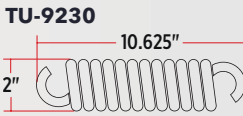
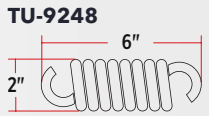

**WARNING:** Cancer and Reproductive Harm - [www.p65warnings.ca.gov](http://www.p65warnings.ca.gov)

# UNIVERSAL ACCESSORIES

## 45° ANGLED 30" MUD FLAP HANGERS - 2 1/2" BOLT SPACING SPRING LOADED - CLOSED END CAP



CHROME METAL  
**TU-9227**



PAINTED STEEL  
**TU-9228**



STAINLESS STEEL  
**TU-9229**

### TECHNICAL SPECIFICATIONS

BOLT SPACING	2 1/2"
WHAT'S INCLUDED	Locking Nuts
SOLD	As a Pair
WARRANTY	1 Year

Attach to the chassis using a hand wrench & supplied hardware. Warranty VOID if power tools are used for the installation.

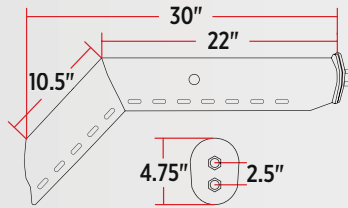

## 45° ANGLED 30" MUD FLAP HANGERS - 1 1/8" BOLT SPACING SPRING LOADED - CLOSED END CAP



CHROME STEEL  
**TU-9221**



PAINTED STEEL  
**TU-9222**



STAINLESS STEEL  
**TU-9223**

### TECHNICAL SPECIFICATIONS

BOLT SPACING	1 1/8"
WHAT'S INCLUDED	Locking Nuts
SOLD	As a Pair
WARRANTY	1 Year

Attach to the chassis using a hand wrench & supplied hardware. Warranty VOID if power tools are used for the installation.

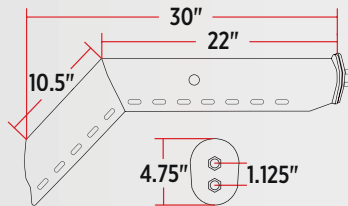

WARNING: Cancer and Reproductive Harm - [www.p65warnings.ca.gov](http://www.p65warnings.ca.gov)

# 30" MUD FLAP HANGERS - 2 1/2" BOLT SPACING

SPRING LOADED - OPEN END CAP

**TOP  
SELLER**



STAINLESS STEEL  
**TU-9214**



CHROME STEEL  
**TU-9232**



PAINTED STEEL  
**TU-9233**

**TECHNICAL SPECIFICATIONS**

BOLT SPACING	2 1/2"
WHAT'S INCLUDED	Locking Nuts
SOLD	As a Pair
WARRANTY	1 Year

Attach to the chassis using a hand wrench & supplied hardware. Warranty VOID if power tools are used for the installation.

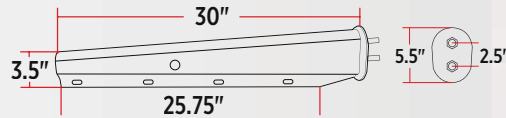

**SOLD IN  
RETAIL PACKAGING**

# 30" MUD FLAP HANGERS - 1 1/8" BOLT SPACING

SPRING LOADED - OPEN END CAP

**TOP  
SELLER**



STAINLESS STEEL  
**TU-9215**



STAINLESS STEEL - SLIM DESIGN  
**TU-9226** With Dual Back Plate



CHROME STEEL  
**TU-9224**



PAINTED STEEL  
**TU-9225**

**TECHNICAL SPECIFICATIONS**

BOLT SPACING	1 1/8"
WHAT'S INCLUDED	Locking Nuts
SOLD	As a Pair
WARRANTY	1 Year

Attach to the chassis using a hand wrench & supplied hardware. Warranty VOID if power tools are used for the installation.

**TU-9215 / TU-9224 / TU-9225**

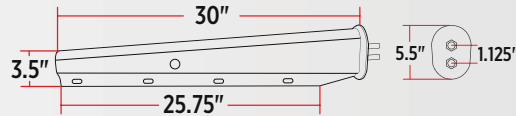

**TU-9226**

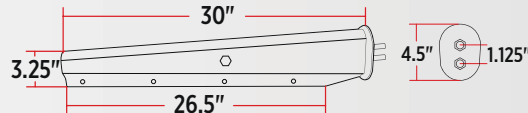

**WARNING:** Cancer and Reproductive Harm - [www.p65warnings.ca.gov](http://www.p65warnings.ca.gov)

# UNIVERSAL ACCESSORIES

## 3 BELL TRAIN HORN CHROME

**TOP  
SELLER**



130-135 DECIBELS  
**THORN-1**

### TECHNICAL SPECIFICATIONS

MATERIAL	Zinc Plated with Chrome
OPERATING VOLTAGE	12-24 Volts
DECIBELS	130-135 Decibels
DIAPHRAGM MATERIAL	Chrome Metal
REQUIREMENT	Minimum 120 PSI of Air
WHAT'S INCLUDED	Mounting Bracket Electric Solenoid Valve
SOLD	Individually
WARRANTY	1 Year

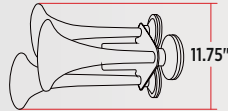
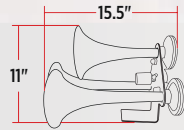

## 4 BELL TRAIN HORN CHROME



140-145 DECIBELS  
**THORN-2**

### TECHNICAL SPECIFICATIONS

MATERIAL	Zinc Plated with Chrome
OPERATING VOLTAGE	12-24 Volts
DECIBELS	140-145 Decibels
DIAPHRAGM MATERIAL	Chrome Metal
REQUIREMENT	Minimum 120 PSI of Air
WHAT'S INCLUDED	Mounting Bracket Electric Solenoid Valve
SOLD	Individually
WARRANTY	1 Year

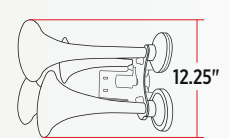
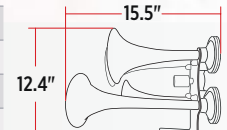

## TRAIN HORN DIAPHRAGM REPLACEMENT



DIAPHRAGM  
**THORN-D**

### TECHNICAL SPECIFICATIONS

MATERIAL	Chrome Metal
SOLD	Individually

Remove the back cap off the Train Horn and attach using the existing hardware.

## TRAIN HORN SOLENOID VALVE REPLACEMENT



REPLACEMENT SOLENOID VALVE  
**THORN-SV**

### TECHNICAL SPECIFICATIONS

OPERATING VOLTAGE	12-24 Volts
SOLD	Individually

Replacement Valve for THORN-1 & THORN-2



# LICENSE PLATE HOLDERS

## STAINLESS STEEL



▲  
TRIPLE PLATE  
**TU-1714**



▲  
DOUBLE PLATE  
**TU-1715**



▲  
SINGLE PLATE  
**TU-1716**

**TECHNICAL SPECIFICATIONS**

SOLD	Individually
MATERIAL	Stainless Steel

INCLUDES	License Plate Bezels All Hardware
----------	--------------------------------------

Mounts onto the bottom edge of the front bumper using supplied hardware.

# 5TH WHEEL PULLER

## CHROMED STEEL



▲  
WITH HOOK  
**TU-1030**

**TECHNICAL SPECIFICATIONS**

DIMENSIONS	Full Pole: 36" Long x 0.375" Diameter Handle: 4.88" Long x 0.75" Diameter
SOLD	Individually
MATERIAL	Chromed Steel

For Installation, Reach & Release 'King Pin' from under the trailer

# BOOT BRUSHES

## CHROMED ALUMINUM - BLACK BRISTLES



▲  
NO LEDs  
**TU-1400**

**TECHNICAL SPECIFICATIONS**

DIMENSIONS	7.5" x 3.25" x 1.75"
SOLD	Individually
MATERIAL	Chromed Aluminum

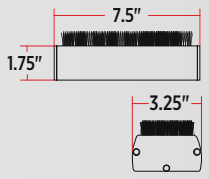

# UNIVERSAL ACCESSORIES

## 24" BOLTED BOTTOM MUD FLAP WEIGHTS STAINLESS STEEL

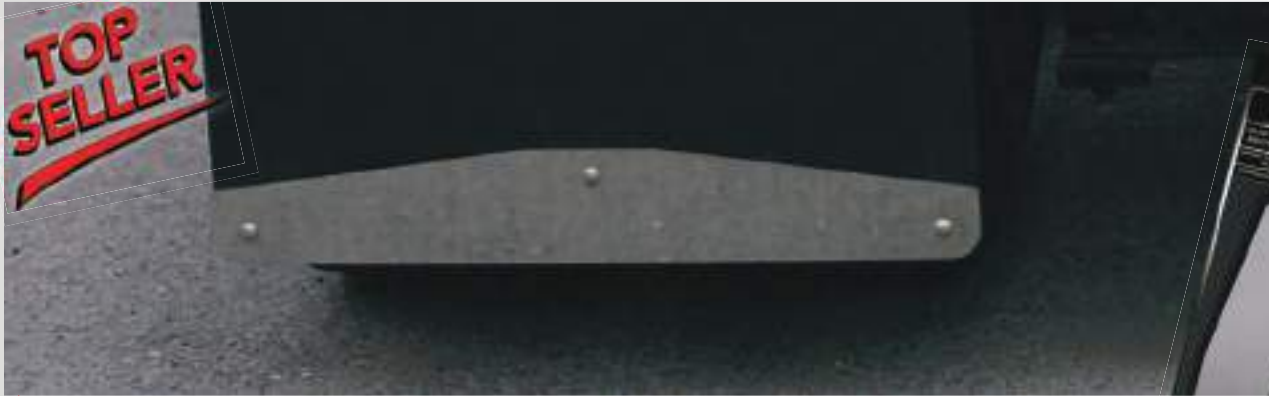

ANGLED  
**TU-9246** With Backing Plates

### TECHNICAL SPECIFICATIONS

WHAT'S INCLUDED	Bolt Kit
MATERIAL	Stainless Steel
SOLD	As a Pair
WARRANTY	1 Year



**SOLD IN  
RETAIL  
PACKAGING**

## 24" BOLTED BOTTOM MUD FLAP WEIGHTS - STAINLESS STEEL



WAVE  
**TU-9239**

### TECHNICAL SPECIFICATIONS

WHAT'S INCLUDED	Bolt Kit
MATERIAL	Stainless Steel
SOLD	As a Pair
WARRANTY	1 Year

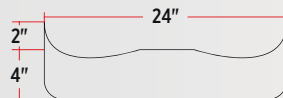

## 24" WELDED BOTTOM MUD FLAP WEIGHTS



ANGLED  
**TU-9204** Stainless Steel  
**TU-9241** Stainless Steel  
with Backing Plate  
**TU-9242** Chrome

### TECHNICAL SPECIFICATIONS

WHAT'S INCLUDED	Welded Studs & Hardware
SOLD	TU-9204: As a Pair TU-9241: Individually TU-9242: Individually
WARRANTY	1 Year

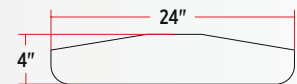

WARNING: Cancer and Reproductive Harm - [www.p65warnings.ca.gov](http://www.p65warnings.ca.gov)

# ANTI-SAIL BRACKETS

CHROME | STAINLESS STEEL



CHROME  
**TU-1031**

STAINLESS STEEL  
**TU-1032**

**TECHNICAL SPECIFICATIONS**

DIMENSIONS	24" x 21"
SOLD	Individually
WARRANTY	1 Year

# ANTI-SAIL FLAP PLATE

STAINLESS STEEL



STAINLESS STEEL  
**TU-9208**

**TECHNICAL SPECIFICATIONS**

DESIGNED FOR	Straight Mud Flaps
DIMENSIONS	14" x 18"
SOLD	As a Pair
WARRANTY	1 Year

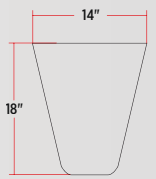

Reduces Wear & Tear by securing Mud Flap into place.  
Will NOT fit angled Mud Flaps.

# MUD FLAPS

CHROME



CHROME  
**TM-24** 24" x 24" (W x H)  
**TM-30** 24" x 30" (W x H)

**TECHNICAL SPECIFICATIONS**

SOLD	As a Pair
------	-----------



# UNIVERSAL ACCESSORIES



- 430 Mirror Shine Stainless Steel
- LED Lighting with Grommets & Bezels\*
- License Plate Frame with License LEDs\*
- Pre-Wired & Assembled\*
- Aluminum Composite Back Plate
- Reinforced Brackets for Mounting Holes

\*Applies to Specific Products



**SOLD IN**  
RETAIL PACKAGING

## LED REAR CENTER PANELS - 4" & 2" STANDARD LEDS STAINLESS STEEL



4 x 4" HOLES & 6 x 2" HOLES  
**TU-9001**

**TOP  
SELLER**



RED STOP, TURN & TAIL  
**TU-9001L Red Lens**



RED STOP, TURN & TAIL  
**TU-9001LC Clear Lens**

### TECHNICAL SPECIFICATIONS

DOT/SAE	Compliant
FUNCTION	Stop, Turn & Tail
WARRANTY	1 Year



TU-9001LC OFF

PART NUMBER	TU-9001	TU-9001L	TU-9001LC
KIT INCLUDES	1 x Rear Center Panel 1 x Composite Back Plate	1 x Rear Center Panel 4 x TLED-48R 6 x TLED-2R 4 x TBEZ-4CH4 6 x TBEZ-2CH4 4 x TGRO-4R 6 x TGRO-2R 1 x License Plate 2 x License LEDs 1 x Composite Back Plate	1 x Rear Center Panel 4 x TLED-48CR 6 x TLED-2TR 4 x TBEZ-4CH4 6 x TBEZ-2CH4 4 x TGRO-4R 6 x TGRO-2R 1 x License Plate 2 x License LEDs 1 x Composite Back Plate

WARNING: Cancer and Reproductive Harm - [www.p65warnings.ca.gov](http://www.p65warnings.ca.gov)

# LED REAR CENTER PANELS - 4" & 2" DUAL REVOLUTION LEDS STAINLESS STEEL

**TOP SELLER**



▲ **RED STOP, TURN & TAIL TO WHITE BACK UP**  
**TU-9001L2** Clear Lens



▲ **RED STOP, TURN & TAIL TO WHITE BACK UP**  
**TU-9001L3** Clear Lens



▲ **RED STOP, TURN & TAIL TO BLUE AUXILIARY**  
**TU-9001L4** Clear Lens



▲ **RED STOP, TURN & TAIL TO PURPLE AUXILIARY**  
**TU-9001L5** Clear Lens



▲ **RED STOP, TURN & TAIL TO GREEN AUXILIARY**  
**TU-9001L6** Clear Lens

**TECHNICAL SPECIFICATIONS**

DOT/SAE	DOT to Auxiliary
FUNCTIONS	Stop, Turn & Tail to Auxiliary
WARRANTY	1 Year

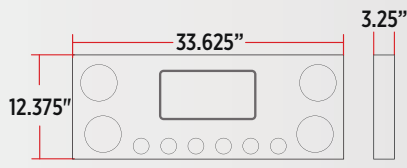

PART NUMBER	TU-9001L2	TU-9001L3	TU-9001L4	TU-9001L5	TU-9001L6
KIT INCLUDES	1 x Rear Center Panel 2 x TLED-419CR 2 x TLED-4X40 6 x TLED-2XRW 4 x TBEZ-4CH4 6 x TBEZ-2CH4 4 x TGRO-4R 6 x TGRO-2R 1 x License Plate 2 x License LEDs 1 x Composite Back Plate	1 x Rear Center Panel 4 x TLED-4X40 6 x TLED-2XRW 4 x TBEZ-4CH4 6 x TBEZ-2CH4 4 x TGRO-4R 6 x TGRO-2R 1 x License Plate 2 x License LEDs 1 x Composite Back Plate	1 x Rear Center Panel 4 x TLED-4XRB 6 x TLED-2XRB 4 x TBEZ-4CH4 6 x TBEZ-2CH4 4 x TGRO-4R 6 x TGRO-2R 1 x License Plate 2 x License LEDs 1 x Composite Back Plate	1 x Rear Center Panel 4 x TLED-4XRP 6 x TLED-2XRP 4 x TBEZ-4CH4 6 x TBEZ-2CH4 4 x TGRO-4R 6 x TGRO-2R 1 x License Plate 2 x License LEDs 1 x Composite Back Plate	1 x Rear Center Panel 4 x TLED-4XRG 6 x TLED-2XRG 4 x TBEZ-4CH4 6 x TBEZ-2CH4 4 x TGRO-4R 6 x TGRO-2R 1 x License Plate 2 x License LEDs 1 x Composite Back Plate

# UNIVERSAL ACCESSORIES



- 430 Mirror Shine Stainless Steel
- LED Lighting with Grommets & Bezels\*
- License Plate Frame with License LEDs\*
- Pre-Wired & Assembled\*
- Aluminum Composite Back Plate
- Reinforced Brackets for Mounting Holes

\*Applies to Specific Products



**SOLD IN**  
RETAIL PACKAGING

## LED REAR CENTER PANELS - 4" & 2.5" STANDARD LEDS STAINLESS STEEL



4 x 4" HOLES & 5 x 2.5" HOLES  
**TU-9002**

**TOP  
SELLER**



RED STOP, TURN & TAIL  
**TU-9002L Red Lens**



RED STOP, TURN & TAIL  
**TU-9002LC Clear Lens**

### TECHNICAL SPECIFICATIONS

DOT/SAE	Compliant
FUNCTION	Stop, Turn & Tail
WARRANTY	1 Year

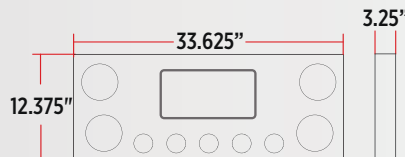

PART NUMBER	TU-9002	TU-9002L	TU-9002LC
KIT INCLUDES	1 x Rear Center Panel 1 x Composite Back Plate	1 x Rear Center Panel 4 x TLED-48R 5 x TLED-2HR 4 x TBEZ-4CH4 5 x TBEZ-2HCH4 4 x TGRO-4R 5 x TGRO-2HRO 1 x License Plate 2 x License LEDs 1 x Composite Back Plate	1 x Rear Center Panel 4 x TLED-48CR 5 x TLED-2HTR 4 x TBEZ-4CH4 5 x TBEZ-2HCH4 4 x TGRO-4R 5 x TGRO-2HRO 1 x License Plate 2 x License LEDs 1 x Composite Back Plate

WARNING: Cancer and Reproductive Harm - [www.p65warnings.ca.gov](http://www.p65warnings.ca.gov)

# LED REAR CENTER PANELS - 4" & 2.5" DUAL REVOLUTION LEDS STAINLESS STEEL

**TOP  
SELLER**



▲ **RED STOP, TURN & TAIL TO WHITE BACK UP**  
**TU-9002L2** Clear Lens



▲ **RED STOP, TURN & TAIL TO WHITE BACK UP**  
**TU-9002L3** Clear Lens



▲ **RED STOP, TURN & TAIL TO BLUE AUXILIARY**  
**TU-9002L4** Clear Lens



▲ **RED STOP, TURN & TAIL TO PURPLE AUXILIARY**  
**TU-9002L5** Clear Lens



▲ **RED STOP, TURN & TAIL TO GREEN AUXILIARY**  
**TU-9002L6** Clear Lens

**TECHNICAL SPECIFICATIONS**

DOT/SAE	DOT to Auxiliary
FUNCTIONS	Stop, Turn & Tail to Auxiliary
WARRANTY	1 Year

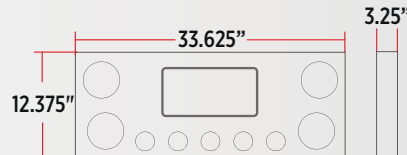

PART NUMBER	TU-9002L2	TU-9002L3	TU-9002L4	TU-9002L5	TU-9002L6
KIT INCLUDES	1 x Rear Center Panel 2 x TLED-419CR 2 x TLED-4X40 5 x TLED-2HXRW 4 x TBEZ-4CH4 5 x TBEZ-2HCH4 4 x TGRO-4R 5 x TGRO-2HRO 1 x License Plate 2 x License LEDs 1 x Composite Back Plate	1 x Rear Center Panel 4 x TLED-4X40 5 x TLED-2HXRW 4 x TBEZ-4CH4 5 x TBEZ-2HCH4 4 x TGRO-4R 5 x TGRO-2HRO 1 x License Plate 2 x License LEDs 1 x Composite Back Plate	1 x Rear Center Panel 4 x TLED-4XRB 5 x TLED-2HXRW 4 x TBEZ-4CH4 5 x TBEZ-2HCH4 4 x TGRO-4R 5 x TGRO-2HRO 1 x License Plate 2 x License LEDs 1 x Composite Back Plate	1 x Rear Center Panel 4 x TLED-4XRP 5 x TLED-2HXRW 4 x TBEZ-4CH4 5 x TBEZ-2HCH4 4 x TGRO-4R 5 x TGRO-2HRO 1 x License Plate 2 x License LEDs 1 x Composite Back Plate	1 x Rear Center Panel 4 x TLED-4XRG 5 x TLED-2HXRW 4 x TBEZ-4CH4 5 x TBEZ-2HCH4 4 x TGRO-4R 5 x TGRO-2HRO 1 x License Plate 2 x License LEDs 1 x Composite Back Plate

# UNIVERSAL ACCESSORIES

- 430 Mirror Shine Stainless Steel
- LED Lighting with Grommets & Bezels\*
- License Plate Frame with License LEDs\*

- Pre-Wired & Assembled\*
- Aluminum Composite Back Plate
- Reinforced Brackets for Mounting Holes

\*Applies to Specific Products

## LED REAR CENTER PANELS - 4" ROUND STANDARD | DUAL REVOLUTION LEDS - STAINLESS STEEL



4 x 4" HOLES  
**TU-9017**



**TU-9017L1** Red Lens



**TU-9017LC** Clear Lens



**TU-9017L2** Clear Lens

**TU-9017L4** Clear Lens

### TECHNICAL SPECIFICATIONS

DOT/SAE	Compliant
FUNCTION	TU-9017L1/LC: Stop, Turn & Tail TU-9017L2/L4: Stop, Turn & Tail To Back Up
WARRANTY	1 Year

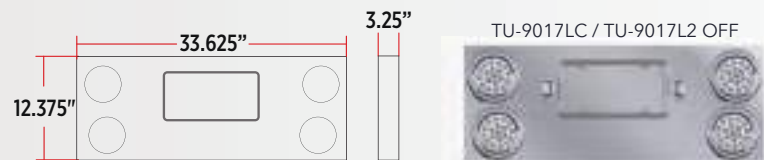

PART NUMBER	TU-9017	TU-9017L1	TU-9017LC	TU-9017L2	TU-9017L4
KIT INCLUDES	1 x Rear Center Panel 1 x Composite Back Plate	1 x Rear Center Panel 4 x TLED-48R 4 x TBEZ-4CH4 4 x TGRO-4R 1 x License Plate 2 x License LEDs 1 x Composite Back Plate	1 x Rear Center Panel 4 x TLED-48CR 4 x TBEZ-4CH4 4 x TGRO-4R 1 x License Plate 2 x License LEDs 1 x Composite Back Plate	1 x Rear Center Panel 4 x TLED-4X40 4 x TBEZ-4CH4 4 x TGRO-4R 1 x License Plate 2 x License LEDs 1 x Composite Back Plate	1 x Rear Center Panel 2 x TLED-4X40 2 x TLED-419CR 4 x TBEZ-4CH4 4 x TGRO-4R 1 x License Plate 2 x License LEDs 1 x Composite Back Plate

⚠ WARNING: Cancer and Reproductive Harm - [www.p65warnings.ca.gov](http://www.p65warnings.ca.gov)



# LED REAR CENTER PANELS - OVAL & 2.5" STANDARD LEDS

## STAINLESS STEEL



4 x OVAL HOLES & 4 x 2.5" HOLES  
**TU-9008**



RED STOP, TURN & TAIL  
**TU-9008L Red Lens**



RED STOP, TURN & TAIL  
**TU-9008LC Clear Lens**

**TECHNICAL SPECIFICATIONS**

DOT/SAE	Compliant
FUNCTION	Stop, Turn & Tail
WARRANTY	1 Year

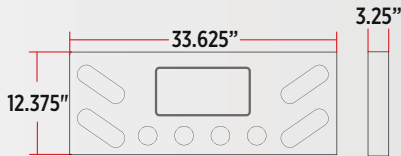

PART NUMBER	TU-9008	TU-9008L	TU-9008LC
KIT INCLUDES	1 x Rear Center Panel 1 x Composite Back Plate	1 x Rear Center Panel 4 x TLED-OBMR 4 x TLED-2HR 4 x TBEZ-OBCH4 4 x TBEZ-2HCH4 4 x TGRO-OBR 4 x TGRO-2HRO 1 x License Plate 1 x License LEDs 1 x Composite Back Plate	1 x Rear Center Panel 4 x TLED-OBMCR 4 x TLED-2HTR 4 x TBEZ-OBCH4 4 x TBEZ-2HCH4 4 x TGRO-OBR 4 x TGRO-2HRO 1 x License Plate 1 x License LEDs 1 x Composite Back Plate

# LED REAR CENTER PANELS - 4" & 2" STANDARD LEDS

## EXTRA WIDE - STAINLESS STEEL



RED STOP, TURN & TAIL  
**TU-9013L Red Lens**



RED STOP, TURN & TAIL  
**TU-9013LC Clear Lens**

**TECHNICAL SPECIFICATIONS**

DOT/SAE	Compliant
FUNCTION	Stop, Turn & Tail
WARRANTY	1 Year

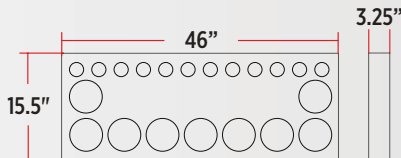

PART NUMBER	TU-9013L	TU-9013LC
KIT INCLUDES	1 x Rear Center Panel 9 x TLED-48R 12 x TLED-2R 9 x TBEZ-4CH4 12 x TBEZ-2CH4 9 x TGRO-4R 12 x TGRO-2R	1 x Rear Center Panel 9 x TLED-48CR 12 x TLED-2TR 9 x TBEZ-4CH4 12 x TBEZ-2CH4 9 x TGRO-4R 12 x TGRO-2R

# UNIVERSAL ACCESSORIES

## LED AIR LINE BOX - 4" & 2" STANDARD LEDS OPEN BACK - STAINLESS STEEL



2 x 4" HOLES & 5 x 2" HOLES  
**TU-1601**



**TOP SELLER**  
RED STOP, TURN & TAIL  
**TU-1601L Red Lens**



RED STOP, TURN & TAIL  
**TU-1601LC Clear Lens**

### TECHNICAL SPECIFICATIONS

DOT/SAE	Compliant
FUNCTION	Stop, Turn & Tail
WARRANTY	1 Year

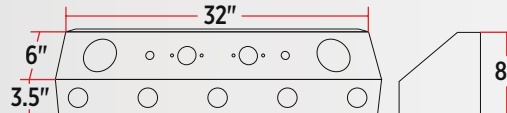

PART NUMBER	TU-1601	TU-1601L	TU-1601LC
KIT INCLUDES	1 x Air Line Box 1 x Bracket Kit All Hardware	1 x Air Line Box 1 x Bracket Kit 2 x TLED-48R 5 x TLED-2R 4 x TBEZ-4CH4 5 x TBEZ-2CH4 2 x TGRO-4R 5 x TGRO-2R All Hardware	1 x Air Line Box 1 x Bracket Kit 2 x TLED-48CR 5 x TLED-2TR 4 x TBEZ-4CH4 5 x TBEZ-2CH4 2 x TGRO-4R 5 x TGRO-2R All Hardware

TU-1601LC OFF



BRACKET KIT INCLUDED



WARNING: Cancer and Reproductive Harm - [www.p65warnings.ca.gov](http://www.p65warnings.ca.gov)

# LED AIR LINE BOX - 4" & 2" DUAL REVOLUTION LEDS

OPEN BACK - STAINLESS STEEL



RED STOP, TURN & TAIL TO **WHITE** BACK UP  
**TU-1601L2** Clear Lens



RED STOP, TURN & TAIL TO **BLUE** AUXILIARY  
**TU-1601L3** Clear Lens



RED STOP, TURN & TAIL TO **GREEN** AUXILIARY  
**TU-1601L4** Clear Lens



RED STOP, TURN & TAIL TO **PURPLE** AUXILIARY  
**TU-1601L5** Clear Lens

**TECHNICAL SPECIFICATIONS**

DOT/SAE	DOT to Auxiliary
FUNCTIONS	Stop, Turn & Tail to Auxiliary
WARRANTY	1 Year

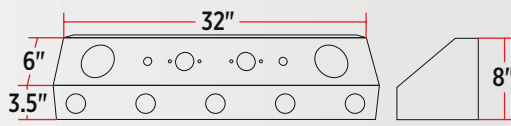

PART NUMBER	TU-1601L2	TU-1601L3	TU-1601L4	TU-1601L5
KIT INCLUDES	1 x Air Line Box 1 x Bracket Kit 2 x TLED-4X40 5 x TLED-2XRW 2 x TBEZ-4CH4 5 x TBEZ-2CH4 2 x TGRO-4R 5 x TGRO-2R All Hardware	1 x Air Line Box 1 x Bracket Kit 2 x TLED-4XRB 5 x TLED-2XRB 2 x TBEZ-4CH4 5 x TBEZ-2CH4 2 x TGRO-4R 5 x TGRO-2R All Hardware	1 x Air Line Box 1 x Bracket Kit 2 x TLED-4XRG 5 x TLED-2XRG 2 x TBEZ-4CH4 5 x TBEZ-2CH4 2 x TGRO-4R 5 x TGRO-2R All Hardware	1 x Air Line Box 1 x Bracket Kit 2 x TLED-4XRP 5 x TLED-2XRP 2 x TBEZ-4CH4 5 x TBEZ-2CH4 2 x TGRO-4R 5 x TGRO-2R All Hardware



**WARNING:** Cancer and Reproductive Harm - [www.p65warnings.ca.gov](http://www.p65warnings.ca.gov)

# UNIVERSAL ACCESSORIES

## WEST COAST MIRRORS 7" WIDE x 16" HIGH - STAINLESS STEEL



STANDARD  
**TM-2009**



HEATED  
**TM-2008**



HEATED WITH INCANDESCENT  
**TM-2011**

### TECHNICAL SPECIFICATIONS

PART NUMBER	TM-2009	TM-2008	TM-2011
WHAT'S INCLUDED	Mounting Hardware	1 x Heating Element Mounting Hardware	1 x Heating Element 1 x Incandescent Light Mounting Hardware
OPERATING VOLTAGE	N/A	12 Volts	12 Volts
SOLD	Individually	Individually	Individually
WARRANTY	1 Year	1 Year	1 Year

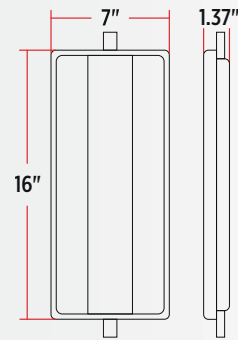

WARNING: Cancer and Reproductive Harm - [www.p65warnings.ca.gov](http://www.p65warnings.ca.gov)

# 8" CONVEX MIRRORS

STAINLESS STEEL



NO LED  
**TM-2002** Center Mount



NO LED  
**TM-2003** Offset Mount

**TECHNICAL SPECIFICATIONS**

PART NUMBER	TM-2002	TM-2003
WHAT'S INCLUDED	L Bracket & Mounting Hardware	L Bracket & Mounting Hardware
SOLD	Individually	Individually
WARRANTY	1 Year	1 Year

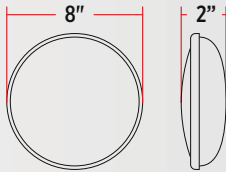

 **WARNING:** Cancer and Reproductive Harm - [www.p65warnings.ca.gov](http://www.p65warnings.ca.gov)

# FENDERS

## 24" TUBE MOUNT QUARTER FENDER KIT

**TOP  
SELLER**



ROLLED EDGE  
**TFEN-Q17** 18 Gauge

### TECHNICAL SPECIFICATIONS

FENDER LENGTH	24"
MATERIAL	Stainless Steel
WEIGHT PER SET	25 lbs.
SOLD	As a Kit
WARRANTY	1 Year

### KIT INCLUDES

2 x Fenders  
2 x Tube Mounts  
2 x Clamps  
2 x Top Mud Flaps  
& Hardware

### TUBE MOUNT



**18**  
GAUGE

SOLD AS A  
**KIT**



**WARNING:** Cancer and Reproductive Harm - [www.p65warnings.ca.gov](http://www.p65warnings.ca.gov)

## 24" TRIANGLE MOUNT QUARTER FENDER KIT

**TOP  
SELLER**



ROLLED EDGE  
**TFEN-Q10** 16 Gauge

### TECHNICAL SPECIFICATIONS

FENDER LENGTH	24"
MATERIAL	Stainless Steel
WEIGHT PER SET	25 lbs.
SOLD	As a Kit
WARRANTY	1 Year



### KIT INCLUDES TRIANGLE MOUNT

- 2 x Fenders
- 2 x Triangle Mounts
- 2 x Clamps
- 2 x Top Mud Flaps & Hardware



SOLD AS A  
**KIT**

**16**  
GAUGE

## 24" LOW TUBE MOUNT QUARTER FENDER KIT



OEM REPLACEMENT - ROLLED EDGE  
**TFEN-Q28** 18 Gauge

### TECHNICAL SPECIFICATIONS

FENDER LENGTH	24"
MATERIAL	Stainless Steel
WEIGHT PER SET	32 lbs.
SOLD	As a Kit
WARRANTY	1 Year



### KIT INCLUDES TUBE MOUNT

- 2 x Fenders
- 2 x Tube Mounts
- 2 x Clamps
- 2 x Top Mud Flaps & Hardware



SOLD AS A  
**KIT**

**18**  
GAUGE

## 24" LOW TUBE MOUNT MID BRACED - QUARTER FENDER KIT



OEM REPLACEMENT - ROLLED EDGE  
**TFEN-Q25** 18 Gauge

### TECHNICAL SPECIFICATIONS

FENDER LENGTH	24"
MATERIAL	Stainless Steel
WEIGHT PER SET	32 lbs.
SOLD	As a Kit
WARRANTY	1 Year



### KIT INCLUDES TUBE MOUNT

- 2 x Fenders
- 2 x Tube Mounts
- 2 x Clamps
- 2 x Top Mud Flaps & Hardware



SOLD AS A  
**KIT**

**18**  
GAUGE

## 24" MID TUBE MOUNT DOUBLE BRACED - QUARTER FENDER KIT



OEM REPLACEMENT - ROLLED EDGE  
**TFEN-Q26** 18 Gauge

### TECHNICAL SPECIFICATIONS

FENDER LENGTH	24"
MATERIAL	Stainless Steel
WEIGHT PER SET	32 lbs.
SOLD	As a Kit
WARRANTY	1 Year



### KIT INCLUDES TUBE MOUNT

- 2 x Fenders
- 2 x Tube Mounts
- 2 x Clamps
- 2 x Top Mud Flaps & Hardware



SOLD AS A  
**KIT**

**18**  
GAUGE

WARNING: Cancer and Reproductive Harm - [www.p65warnings.ca.gov](http://www.p65warnings.ca.gov)

# FENDERS

## 27" TRIANGLE MOUNT QUARTER FENDER KIT

**TOP  
SELLER**



ROLLED EDGE

**TFEN-Q11** 16 Gauge

### TECHNICAL SPECIFICATIONS

FENDER LENGTH	27"
MATERIAL	Stainless Steel
WEIGHT PER SET	30 lbs.
SOLD	As a Kit
WARRANTY	1 Year



### KIT INCLUDES

- 2 x Fenders
- 2 x Triangle Mounts
- 2 x Clamps
- 2 x Top Mud Flaps & Hardware

### TRIANGLE MOUNT



SOLD AS A  
**KIT**

**16**  
GAUGE



## 31" TRIANGLE MOUNT LONG STRAIGHT DROP QUARTER FENDER KIT



STRAIGHT DROP - ROLLED EDGE

**TFEN-Q14** 16 Gauge

### TECHNICAL SPECIFICATIONS

FENDER LENGTH	31"
MATERIAL	Stainless Steel
WEIGHT PER SET	43 lbs.
SOLD	As a Kit
WARRANTY	1 Year



### KIT INCLUDES

- 2 x Fenders
- 2 x Triangle Mounts
- 2 x Clamps
- 2 x Top Mud Flaps & Hardware

### TRIANGLE MOUNT



SOLD AS A  
**KIT**

**16**  
GAUGE

## 34" TRIANGLE MOUNT LONG STRAIGHT DROP QUARTER FENDER KIT



LONG STRAIGHT DROP - ROLLED EDGE

**TFEN-Q13** 16 Gauge

### TECHNICAL SPECIFICATIONS

FENDER LENGTH	34"
MATERIAL	Stainless Steel
WEIGHT PER SET	46 lbs.
SOLD	As a Kit
WARRANTY	1 Year



### KIT INCLUDES

- 2 x Fenders
- 2 x Triangle Mounts
- 2 x Clamps
- 2 x Top Mud Flaps & Hardware

### TRIANGLE MOUNT



SOLD AS A  
**KIT**

**16**  
GAUGE

**WARNING:** Cancer and Reproductive Harm - [www.p65warnings.ca.gov](http://www.p65warnings.ca.gov)



## 38" TRIANGLE MOUNT LOW RIDER - QUARTER FENDER KIT



STRAIGHT DROP - ROLLED EDGE  
**TFEN-Q21** 14 Gauge

### TECHNICAL SPECIFICATIONS

FENDER LENGTH	38"
MATERIAL	Stainless Steel
WEIGHT PER SET	58 lbs.
SOLD	As a Kit
WARRANTY	1 Year

### KIT INCLUDES

- 2 x Fenders
- 2 x Triangle Mounts
- 2 x Clamps
- 2 x Top Mud Flaps & Hardware

### TRIANGLE MOUNT



SOLD AS A  
**KIT**

**14**  
GAUGE

## 38" TRIANGLE MOUNT ROLLIN' LO - QUARTER FENDER KIT



LONG CURVED DROP - ROLLED EDGE  
**TFEN-Q12** 14 Gauge

### TECHNICAL SPECIFICATIONS

FENDER LENGTH	38"
MATERIAL	Stainless Steel
WEIGHT PER SET	58 lbs.
SOLD	As a Kit
WARRANTY	1 Year

### KIT INCLUDES

- 2 x Fenders
- 2 x Triangle Mounts
- 2 x Clamps
- 2 x Top Mud Flaps & Hardware

### TRIANGLE MOUNT



SOLD AS A  
**KIT**

**14**  
GAUGE

# JOIN TRUX'S STAINLESS FENDER PROGRAM AND RECIEVE A FREE DISPLAY!

CONTACT YOUR TRUX ACCOUNT MANAGER TODAY!



## STARTER

**TRX-168**

'STARTER' FENDER DISPLAY  
RETAIL SPACE: 36" X 24" X 47"



## STANDARD

**TRX-167**

'STANDARD' FENDER DISPLAY  
RETAIL SPACE: 36" X 24" X 47"



## PREMIUM

**TRX-113**

'PREMIUM' FENDER DISPLAY  
RETAIL SPACE: 43" x 48" x 92"

# FENDERS

## 60" SMOOTH FLANGED HALF FENDERS

**TOP  
SELLER**



FLANGE

ROLLED EDGE WITH FLANGE  
**TFEN-H12** 16 Gauge

### TECHNICAL SPECIFICATIONS

FENDER LENGTH	60"
MATERIAL	Stainless Steel
WEIGHT PER SET	55 lbs.
SOLD	As a Pair
WARRANTY	1 Year

DESIGNED TO FIT	<b>43.5"/46.5" O.D TIRES</b>
-----------------	------------------------------

Trux recommends installing with Mounting Kits that are the SAME OR THICKER Gauge than the fender. **TFEN-HKIT, TFEN-HKITN, TFEN-HKITHD, TFEN-HKIT2 or TFEN-HKIT2HD** (Page 171)

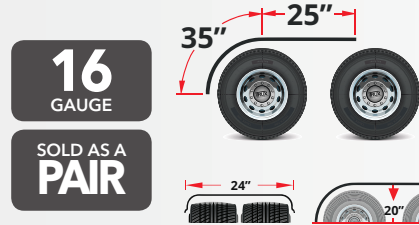

## 60" SMOOTH HEAVY DUTY - HALF FENDERS



ROLLED EDGE  
**TFEN-H59** 14 Gauge

### TECHNICAL SPECIFICATIONS

FENDER LENGTH	60"
MATERIAL	Stainless Steel
WEIGHT PER SET	69 lbs.
SOLD	As a Pair
WARRANTY	1 Year
DESIGNED TO FIT	<b>43.5"/46.5" O.D TIRES</b>

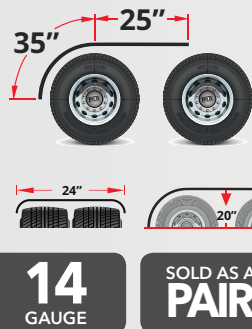

Trux recommends installing with Mounting Kits that are the SAME OR THICKER Gauge than the fender. **TFEN-HKITHD or TFEN-HKIT2HD** (Page 171)

## 66" SMOOTH STANDARD | HEAVY DUTY - HALF FENDERS



ROLLED EDGE  
**TFEN-H55** 16 Gauge  
**TFEN-H61** 14 Gauge

### TECHNICAL SPECIFICATIONS

FENDER LENGTH	66"
MATERIAL	Stainless Steel
SOLD	As a Pair
WEIGHT PER SET	TFEN-H55: 61 lbs. TFEN-H61: 76 lbs.
WARRANTY	1 Year
DESIGNED TO FIT	<b>43.5"/46.5" O.D TIRES</b>

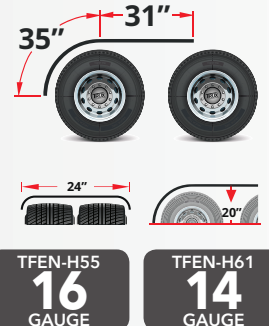

Trux recommends installing with Mounting Kits that are the SAME OR THICKER Gauge from the fender. TFEN-H55: **TFEN-HKIT, TFEN-HKITN, TFEN-HKITHD, TFEN-HKIT2 or TFEN-HKIT2HD** (Page 171) TFEN-H61: **TFEN-HKITHD or TFEN-HKIT2HD** (Page 171)

**SOLD AS A  
PAIR**

**WARNING:** Cancer and Reproductive Harm - [www.p65warnings.ca.gov](http://www.p65warnings.ca.gov)

# 66" SMOOTH FLANGED HALF FENDERS



ROLLED EDGE WITH FLANGE  
**TFEN-H13** 16 Gauge

FLANGE

### TECHNICAL SPECIFICATIONS

FENDER LENGTH	66"
MATERIAL	Stainless Steel
WEIGHT PER SET	61 lbs.
SOLD	As a Pair
WARRANTY	1 Year

DESIGNED TO FIT	<b>43.5"/46.5" O.D TIRES</b>
-----------------	------------------------------

Trux recommends installing with Mounting Kits that are the SAME OR THICKER Gauge than the fender.  
**TFEN-HKIT, TFEN-HKITN, TFEN-HKITHD, TFEN-HKIT2 or TFEN-HKIT2HD** (Page 171)

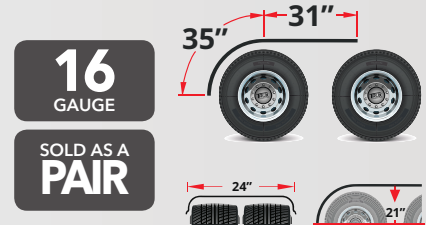

**16 GAUGE**  
**SOLD AS A PAIR**

# 66" SMOOTH LOW PROFILE STANDARD | HEAVY DUTY - HALF FENDERS



ROLLED EDGE  
**TFEN-H21** 16 Gauge  
**TFEN-H20** 14 Gauge

### TECHNICAL SPECIFICATIONS

FENDER LENGTH	66"
MATERIAL	Stainless Steel
WEIGHT PER SET	TFEN-H21: 61 lbs. TFEN-H20: 76 lbs.
SOLD	As a Pair
WARRANTY	1 Year
DESIGNED TO FIT	<b>41.75" O.D TIRES</b>

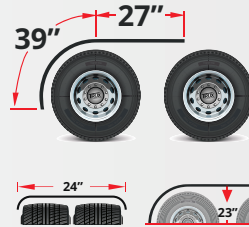

**TFEN-H21**  
**16 GAUGE**  
**TFEN-H20**  
**14 GAUGE**  
**SOLD AS A PAIR**

Trux recommends installing with Mounting Kits that are the SAME OR THICKER Gauge than the fender. TFEN-H21: **TFEN-HKIT, TFEN-HKITN, TFEN-HKITHD, TFEN-HKIT2 or TFEN-HKIT2HD** (Page 171) TFEN-H20: **TFEN-HKITHD or TFEN-HKIT2HD** (Page 171)

# 66" SMOOTH LONG FRONT STANDARD | HEAVY DUTY - HALF FENDERS



ROLLED EDGE  
**TFEN-H15** 16 Gauge  
**TFEN-H54** 14 Gauge

### TECHNICAL SPECIFICATIONS

FENDER LENGTH	66"
MATERIAL	Stainless Steel
WEIGHT PER SET	TFEN-H15: 61 lbs. TFEN-H54: 76 lbs.
SOLD	As a Pair
WARRANTY	1 Year
DESIGNED TO FIT	<b>43.5"/46.5" O.D TIRES</b>

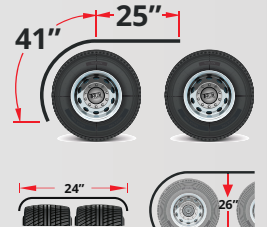

**TFEN-H15**  
**16 GAUGE**  
**TFEN-H54**  
**14 GAUGE**  
**SOLD AS A PAIR**

Trux recommends installing with Mounting Kits that are the SAME OR THICKER Gauge than the fender. TFEN-H15: **TFEN-HKIT, TFEN-HKITN, TFEN-HKITHD, TFEN-HKIT2 or TFEN-HKIT2HD** (Page 171) TFEN-H54: **TFEN-HKITHD or TFEN-HKIT2HD** (Page 171)

# FENDERS

## 72" SMOOTH LONG FRONT HALF FENDERS



ROLLED EDGE  
**TFEN-H16** 16 Gauge  
**TFEN-H50** 14 Gauge

### TECHNICAL SPECIFICATIONS

FENDER LENGTH	72"
MATERIAL	Stainless Steel
WEIGHT PER SET	TFEN-H16: 66 lbs. TFEN-H50: 83 lbs.
SOLD	As a Pair
WARRANTY	1 Year
DESIGNED TO FIT	<b>43.5"/46.5" O.D TIRES</b>

Trux recommends installing with Mounting Kits that are the SAME OR THICKER Gauge than the fender. TFEN-H16: **TFEN-HKIT, TFEN-HKITN, TFEN-HKITHD, TFEN-HKIT2 or TFEN-HKIT2HD** (Page 171)  
 TFEN-H50: **TFEN-HKITHD or TFEN-HKIT2HD** (Page 171)

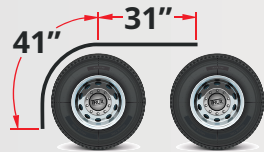

**TFEN-H16**  
**16**  
 GAUGE

**TFEN-H50**  
**14**  
 GAUGE

**SOLD AS A PAIR**

## 80" SMOOTH FLANGED HALF FENDERS

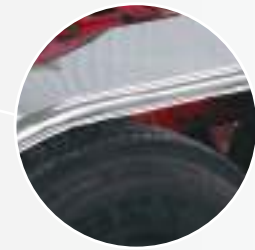

FLANGE

ROLLED EDGE WITH FLANGE  
**TFEN-H14** 16 Gauge

### TECHNICAL SPECIFICATIONS

FENDER LENGTH	80"
MATERIAL	Stainless Steel
WEIGHT PER SET	80 lbs.
SOLD	As a Pair
WARRANTY	1 Year
DESIGNED TO FIT	<b>43.5"/46.5" O.D TIRES</b>

Trux recommends installing with Mounting Kits that are the SAME OR THICKER Gauge than the fender. **TFEN-HKIT, TFEN-HKITN, TFEN-HKITHD, TFEN-HKIT2 or TFEN-HKIT2HD** (Page 171)

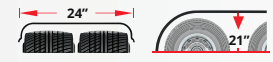
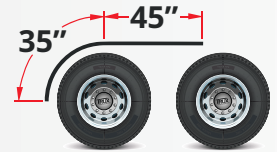

**16**  
 GAUGE

**SOLD AS A PAIR**



**WARNING: Cancer and Reproductive Harm - www.p65warnings.ca.gov**

## 80" SMOOTH ROLLIN' LO - HALF FENDERS



ROLLED EDGE

**TFEN-H10** 16 Gauge  
**TFEN-H52** 14 Gauge

### TECHNICAL SPECIFICATIONS

FENDER LENGTH	80"
MATERIAL	Stainless Steel
WEIGHT PER SET	TFEN-H10: 74 lbs. TFEN-H52: 92 lbs.
SOLD	As a Pair
WARRANTY	1 Year
DESIGNED TO FIT	<b>43.5"/46.5" O.D TIRES</b>

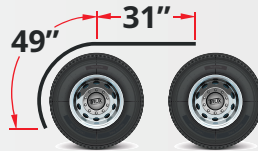

TFEN-H10  
**16**  
GAUGE

TFEN-H52  
**14**  
GAUGE

SOLD AS A  
**PAIR**

Trux recommends installing with Mounting Kits that are the SAME OR THICKER Gauge than the fender. **TFEN-HKIT, TFEN-HKITN, TFEN-HKITHD, TFEN-HKIT2 or TFEN-HKIT2HD** (Page 171)

## 80" SMOOTH LOW PROFILE ROLLIN' LO - HALF FENDERS



ROLLED EDGE

**TFEN-H11** 16 Gauge  
**TFEN-H53** 14 Gauge

### TECHNICAL SPECIFICATIONS

FENDER LENGTH	80"
MATERIAL	Stainless Steel
WEIGHT PER SET	TFEN-H11: 74 lbs. TFEN-H53: 92 lbs.
SOLD	As a Pair
WARRANTY	1 Year
DESIGNED TO FIT	<b>41.75" O.D TIRES</b>

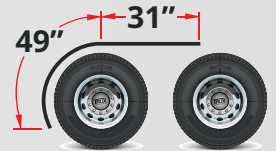

TFEN-H11  
**16**  
GAUGE

TFEN-H53  
**14**  
GAUGE

SOLD AS A  
**PAIR**

Trux recommends installing with Mounting Kits that are the SAME OR THICKER Gauge than the fender. **TFEN-H11: TFEN-HKIT, TFEN-HKITN, TFEN-HKITHD, TFEN-HKIT2 or TFEN-HKIT2HD** (Page 171) **TFEN-H53: TFEN-HKITHD or TFEN-HKIT2HD** (Page 171)



## 80" SMOOTH STRAIGHT DROP LOW RIDER - HALF FENDERS



ROLLED EDGE

**TFEN-H57** 14 Gauge

### TECHNICAL SPECIFICATIONS

FENDER LENGTH	80"
MATERIAL	Stainless Steel
WEIGHT PER SET	92 lbs.
SOLD	As a Pair
WARRANTY	1 Year
DESIGNED TO FIT	<b>43.5"/46.5" O.D TIRES</b>

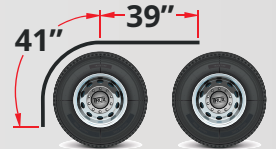

**14**  
GAUGE

SOLD AS A  
**PAIR**

Trux recommends installing with Mounting Kits that are the SAME OR THICKER Gauge than the fender. **TFEN-HKITHD or TFEN-HKIT2HD** (Page 171)

# FENDERS

## 60" 4 RIBBED HALF FENDERS



BEADED EDGE  
**TFEN-H32** 16 Gauge

### TECHNICAL SPECIFICATIONS

FENDER LENGTH	60"
MATERIAL	Stainless Steel
WEIGHT PER SET	52 lbs.
SOLD	As a Pair
WARRANTY	1 Year
DESIGNED TO FIT	<b>43.5" O.D TIRES</b>

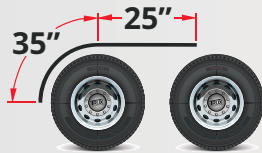

**16**  
GAUGE

**SOLD AS A  
PAIR**

Trux recommends installing with Mounting Kits that are the SAME OR THICKER Gauge than the fender. **TFEN-HKIT**, **TFEN-HKITN**, **TFEN-HKITHD**, **TFEN-HKIT2** or **TFEN-HKIT2HD** (Page 171)

## 66" 4 RIBBED HALF FENDERS



BEADED EDGE  
**TFEN-H34** Stainless Steel  
**TFEN-H35** Galvanized Steel

### TECHNICAL SPECIFICATIONS

FENDER LENGTH	66"
GAUGE	16 ga.
WEIGHT PER SET	TFEN-H34: 45 lbs. TFEN-H35: 59 lbs.
SOLD	As a Pair
WARRANTY	1 Year
DESIGNED TO FIT	<b>43.5" O.D TIRES</b>

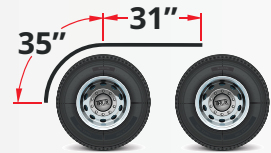

**16**  
GAUGE

**SOLD AS A  
PAIR**

Trux recommends installing with Mounting Kits that are the SAME OR THICKER Gauge than the fender. **TFEN-HKIT**, **TFEN-HKITN**, **TFEN-HKITHD**, **TFEN-HKIT2** or **TFEN-HKIT2HD** (Page 171)

## 80" 4 RIBBED HALF FENDERS



BEADED EDGE  
**TFEN-H37** Stainless Steel  
**TFEN-H38** Galvanized Steel

### TECHNICAL SPECIFICATIONS

FENDER LENGTH	80"
GAUGE	16 ga.
WEIGHT PER SET	TFEN-H37: 72 lbs. TFEN-H38: 64 lbs.
SOLD	As a Pair
WARRANTY	1 Year
DESIGNED TO FIT	<b>43.5" O.D TIRES</b>

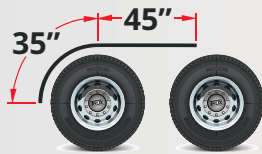

**16**  
GAUGE

**SOLD AS A  
PAIR**

Trux recommends installing with Mounting Kits that are the SAME OR THICKER Gauge than the fender. **TFEN-HKIT**, **TFEN-HKITN**, **TFEN-HKITHD**, **TFEN-HKIT2** or **TFEN-HKIT2HD** (Page 171)

**CAN'T FIND WHAT  
YOU'RE LOOKING FOR?**

**WITH OVER 2000 MORE  
PRODUCTS ON OUR WEBSITE,  
YOU'D BE SURE TO FIND WHAT YOU WANT!**



**VISIT OUR WEBSITE  
TRUXACCESSORIES.COM**

**WARNING: Cancer and Reproductive Harm - www.p65warnings.ca.gov**

## 60" 3 RIBBED HALF FENDERS



ROLLED EDGE  
**TFEN-H27** 16 Gauge

### TECHNICAL SPECIFICATIONS

FENDER LENGTH	60"
MATERIAL	Stainless Steel
WEIGHT PER SET	55 lbs.
SOLD	As a Pair
WARRANTY	1 Year
DESIGNED TO FIT	<b>43.5"/46.5" O.D TIRES</b>

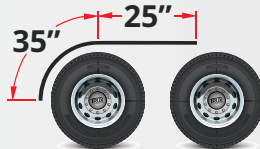

**16**  
GAUGE

**SOLD AS A  
PAIR**

Trux recommends installing with Mounting Kits that are the SAME OR THICKER Gauge than the fender. **TFEN-HKIT, TFEN-HKITN, TFEN-HKITHD, TFEN-HKIT2 or TFEN-HKIT2HD** (Page 171)

## 66" 3 RIBBED HALF FENDERS



ROLLED EDGE  
**TFEN-H29** 16 Gauge

### TECHNICAL SPECIFICATIONS

FENDER LENGTH	66"
MATERIAL	Stainless Steel
WEIGHT PER SET	61 lbs.
SOLD	As a Pair
WARRANTY	1 Year
DESIGNED TO FIT	<b>43.5"/46.5" O.D TIRES</b>

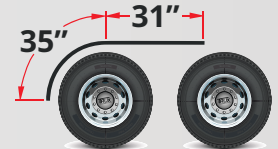

**16**  
GAUGE

**SOLD AS A  
PAIR**

Trux recommends installing with Mounting Kits that are the SAME OR THICKER Gauge than the fender. **TFEN-HKIT, TFEN-HKITN, TFEN-HKITHD, TFEN-HKIT2 or TFEN-HKIT2HD** (Page 171)

## 72" 3 RIBBED HALF FENDERS



ROLLED EDGE  
**TFEN-H31** 16 Gauge

### TECHNICAL SPECIFICATIONS

FENDER LENGTH	72"
MATERIAL	Stainless Steel
WEIGHT PER SET	66 lbs.
SOLD	As a Pair
WARRANTY	1 Year
DESIGNED TO FIT	<b>43.5"/46.5" O.D TIRES</b>

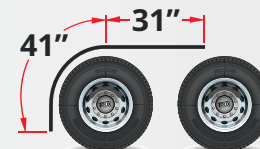

**16**  
GAUGE

**SOLD AS A  
PAIR**

Trux recommends installing with Mounting Kits that are the SAME OR THICKER Gauge than the fender. **TFEN-HKIT, TFEN-HKITN, TFEN-HKITHD, TFEN-HKIT2 or TFEN-HKIT2HD** (Page 171)

## 125" 3 RIBBED HALF FENDERS



ROLLED EDGE  
**TFEN-H24** 16 Gauge

### TECHNICAL SPECIFICATIONS

FENDER LENGTH	125"
MATERIAL	Stainless Steel
WEIGHT PER SET	116 lbs.
SOLD	As a Pair
WARRANTY	1 Year
DESIGNED TO FIT	<b>43.5"/46.5" O.D TIRES</b>

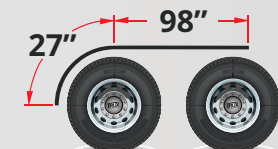

**16**  
GAUGE

**SOLD AS A  
PAIR**

Trux recommends installing with Mounting Kits that are the SAME OR THICKER Gauge than the fender. **TFEN-HKIT, TFEN-HKITN, TFEN-HKITHD, TFEN-HKIT2 or TFEN-HKIT2HD** (Page 171)

# FENDERS

## 144" 3 RIBBED HALF FENDERS



ROLLED EDGE  
**TFEN-H63** 16 Gauge

### TECHNICAL SPECIFICATIONS

FENDER LENGTH	144"
MATERIAL	Stainless Steel
WEIGHT PER SET	134 lbs.
SOLD	As a Pair
WARRANTY	1 Year

DESIGNED TO FIT	<b>43.5"/46.5" O.D TIRES</b>
-----------------	------------------------------

Trux recommends installing with Mounting Kits that are the SAME OR THICKER Gauge than the fender.  
TFEN-HKIT, TFEN-HKITN, TFEN-HKITHD, TFEN-HKIT2 or TFEN-HKIT2HD (Page 171)

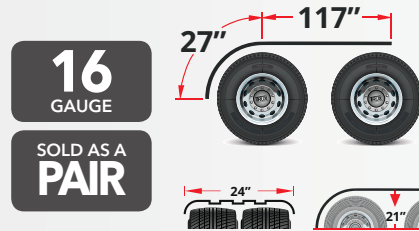

## BEST PACKAGED FENDERS IN THE INDUSTRY

- FENDERS WRAPPED WITH NYLON REINFORCED PACKAGING
- FENDER CORNERS GUARDED WITH PLASTIC PROTECTORS
- FENDERS STRAPPED DOWN TO SKIDS
- FENDERS ALWAYS WELL POSITIONED WITHIN EACH SKID



WARNING: Cancer and Reproductive Harm - [www.p65warnings.ca.gov](http://www.p65warnings.ca.gov)



# 132" SMOOTH FULL FENDERS

**TOP  
SELLER**



ROLLED EDGE  
**TFEN-F12** 16 Gauge  
**TFEN-F11** 14 Gauge

**TECHNICAL SPECIFICATIONS**

FENDER LENGTH	132"
MATERIAL	Stainless Steel
WEIGHT PER SET	TFEN-F11: 152 lbs. TFEN-F12: 122 lbs.
SOLD	As a Pair
WARRANTY	1 Year

DESIGNED TO FIT	<b>43.5" O.D TIRES</b>
-----------------	------------------------

Trux recommends installing with Mounting Kits that are the SAME OR THICKER Gauge than the fender.  
**TFEN-F12: TFEN-FKIT, TFEN-FKITN, TFEN-FKITHD, TFEN-FKIT2 or TFEN-FKIT2HD** (Page 171)  
**TFEN-F11: TFEN-FKITHD or TFEN-FKIT2HD** (Page 171)

TFEN-F12  
**16**  
 GAUGE

TFEN-F11  
**14**  
 GAUGE

**SOLD AS A  
 PAIR**

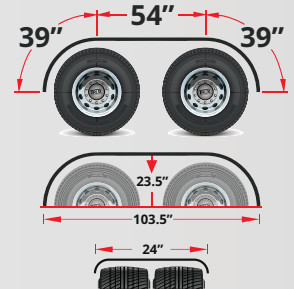

# 132" SMOOTH LOW PROFILE FULL FENDERS



ROLLED EDGE  
**TFEN-F34** 14 Gauge

**TECHNICAL SPECIFICATIONS**

FENDER LENGTH	132"
MATERIAL	Stainless Steel
WEIGHT PER SET	152 lbs.
SOLD	As a Pair
WARRANTY	1 Year

DESIGNED TO FIT	<b>41.75" O.D TIRES</b>
-----------------	-------------------------

Trux recommends installing with Mounting Kits that are the SAME OR THICKER Gauge than the fender.  
**TFEN-FKITHD or TFEN-FKIT2HD** (Page 171)

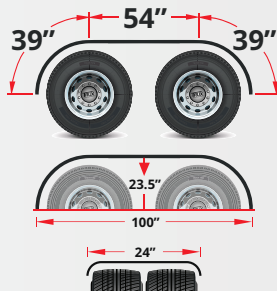

**14**  
 GAUGE

**SOLD AS A  
 PAIR**

# 132" SMOOTH 60" AXLE SPREAD FULL FENDERS



ROLLED EDGE  
**TFEN-F14** 14 Gauge

**TECHNICAL SPECIFICATIONS**

FENDER LENGTH	132"
MATERIAL	Stainless Steel
WEIGHT PER SET	152 lbs.
SOLD	As a Pair
WARRANTY	1 Year

DESIGNED TO FIT	<b>43.5" O.D TIRES</b>
-----------------	------------------------

Trux recommends installing with Mounting Kits that are the SAME OR THICKER Gauge than the fender.  
**TFEN-FKITHD or TFEN-FKIT2HD** (Page 171)

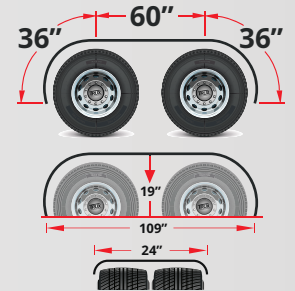

**14**  
 GAUGE

**SOLD AS A  
 PAIR**

**WARNING:** Cancer and Reproductive Harm - [www.p65warnings.ca.gov](http://www.p65warnings.ca.gov)

# FENDERS

## 108" SMOOTH FULL FENDERS



ROLLED EDGE

**TFEN-F41** 16 Gauge

### TECHNICAL SPECIFICATIONS

FENDER LENGTH	108"
MATERIAL	Stainless Steel
WEIGHT PER SET	101 lbs.
SOLD	As a Pair
WARRANTY	1 Year

DESIGNED TO FIT **43.5" O.D TIRES**

Trux recommends installing with Mounting Kits that are the SAME OR THICKER Gauge than the fender. TFEN-FKIT, TFEN-FKITN, TFEN-FKITHD, TFEN-FKIT2 or TFEN-FKIT2HD (Page 171)

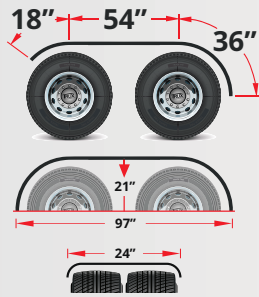

**16**  
GAUGE

SOLD AS A  
**PAIR**

## 120" SMOOTH FULL FENDERS



ROLLED EDGE

**TFEN-F13** 16 Gauge

### TECHNICAL SPECIFICATIONS

FENDER LENGTH	120"
MATERIAL	Stainless Steel
WEIGHT PER SET	111 lbs.
SOLD	As a Pair
WARRANTY	1 Year

DESIGNED TO FIT **43.5" O.D TIRES**

Trux recommends installing with Mounting Kits that are the SAME OR THICKER Gauge than the fender. TFEN-FKIT, TFEN-FKITN, TFEN-FKITHD, TFEN-FKIT2 or TFEN-FKIT2HD (Page 171)

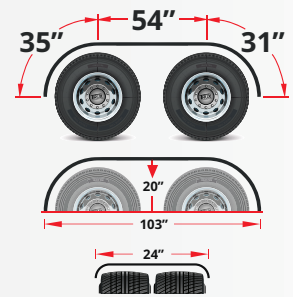

**16**  
GAUGE

SOLD AS A  
**PAIR**

## 142" SMOOTH STRAIGHT DROP - 'THE BOSS' - FULL FENDERS

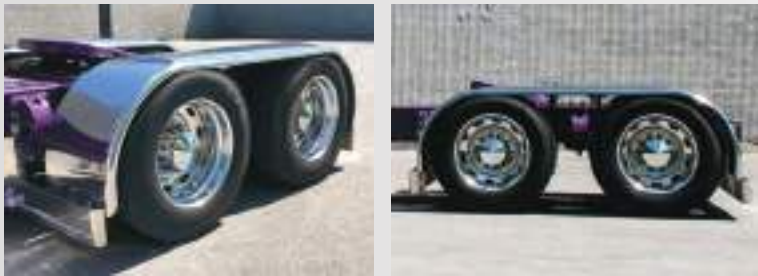

ROLLED EDGE

**TFEN-F10** 14 Gauge

### TECHNICAL SPECIFICATIONS

FENDER LENGTH	142"
MATERIAL	Stainless Steel
WEIGHT PER SET	163 lbs.
SOLD	As a Pair
WARRANTY	1 Year

DESIGNED TO FIT **43.5" O.D TIRES**

Trux recommends installing with Mounting Kits that are the SAME OR THICKER Gauge than the fender. TFEN-FKITHD or TFEN-FKIT2HD (Page 171)

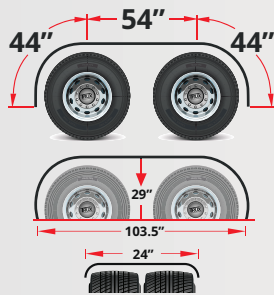

**14**  
GAUGE

SOLD AS A  
**PAIR**

## 142" SMOOTH LOW PROFILE STRAIGHT DROP - 'THE BOSS' - FULL FENDERS



ROLLED EDGE

**TFEN-F33** 14 Gauge

### TECHNICAL SPECIFICATIONS

FENDER LENGTH	142"
MATERIAL	Stainless Steel
WEIGHT PER SET	163 lbs.
SOLD	As a Pair
WARRANTY	1 Year

DESIGNED TO FIT **41.75" O.D TIRES**

Trux recommends installing with Mounting Kits that are the SAME OR THICKER Gauge than the fender. TFEN-FKITHD or TFEN-FKIT2HD (Page 171)

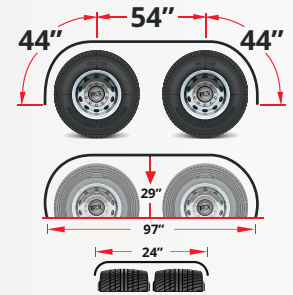

**14**  
GAUGE

SOLD AS A  
**PAIR**

WARNING: Cancer and Reproductive Harm - www.p65warnings.ca.gov

## 120" 4 RIBBED FULL FENDERS



BEADED EDGE

**TFEN-F21** 16 Gauge

### TECHNICAL SPECIFICATIONS

FENDER LENGTH	120"
MATERIAL	Stainless Steel
WEIGHT PER SET	102 lbs.
SOLD	As a Pair
WARRANTY	1 Year
DESIGNED TO FIT	<b>43.5" O.D TIRES</b>

Trux recommends installing with Mounting Kits that are the SAME OR THICKER Gauge than the fender. TFEN-FKIT, TFEN-FKITN, TFEN-FKITHD, TFEN-FKIT2 or TFEN-FKIT2HD (Page 171)

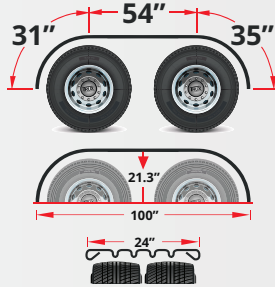

**16**  
GAUGE

SOLD AS A  
**PAIR**

## 116" 4 RIBBED FULL FENDERS



BEADED EDGE

**TFEN-F37** 16 Gauge

### TECHNICAL SPECIFICATIONS

FENDER LENGTH	116"
MATERIAL	Stainless Steel
WEIGHT PER SET	106 lbs.
SOLD	As a Pair
WARRANTY	1 Year
DESIGNED TO FIT	<b>46.5" O.D TIRES</b>

Trux recommends installing with Mounting Kits that are the SAME OR THICKER Gauge than the fender. TFEN-FKIT, TFEN-FKITN, TFEN-FKITHD, TFEN-FKIT2 or TFEN-FKIT2HD (Page 171)

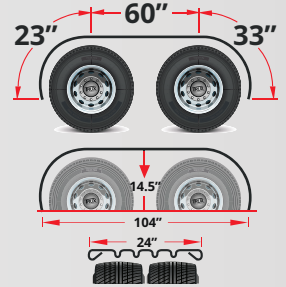

**16**  
GAUGE

SOLD AS A  
**PAIR**

## 108" 3 RIBBED FULL FENDERS



ROLLED EDGE

**TFEN-F15** 16 Gauge

### TECHNICAL SPECIFICATIONS

FENDER LENGTH	108"
MATERIAL	Stainless Steel
WEIGHT PER SET	101 lbs.
SOLD	As a Pair
WARRANTY	1 Year
DESIGNED TO FIT	<b>43.5" O.D TIRES</b>

Trux recommends installing with Mounting Kits that are the SAME OR THICKER Gauge than the fender. TFEN-FKIT, TFEN-FKITN, TFEN-FKITHD, TFEN-FKIT2 or TFEN-FKIT2HD (Page 171)

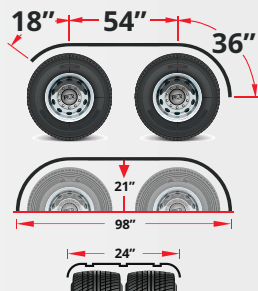

**16**  
GAUGE

SOLD AS A  
**PAIR**

## 120" 3 RIBBED FULL FENDERS



ROLLED EDGE

**TFEN-F17** 16 Gauge

### TECHNICAL SPECIFICATIONS

FENDER LENGTH	120"
MATERIAL	Stainless Steel
WEIGHT PER SET	112 lbs.
SOLD	As a Pair
WARRANTY	1 Year
DESIGNED TO FIT	<b>43.5" O.D TIRES</b>

Trux recommends installing with Mounting Kits that are the SAME OR THICKER Gauge than the fender. TFEN-FKIT, TFEN-FKITN, TFEN-FKITHD, TFEN-FKIT2 or TFEN-FKIT2HD (Page 171)

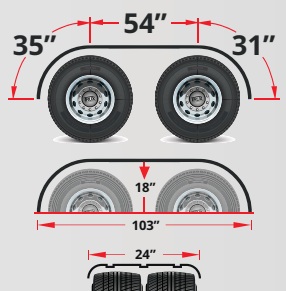

**16**  
GAUGE

SOLD AS A  
**PAIR**

# FENDERS

## 80" SMOOTH SINGLE AXLE FENDERS



ROLLED EDGE  
**TFEN-S13** 16 Gauge  
**TFEN-S12** 14 Gauge

### TECHNICAL SPECIFICATIONS

FENDER LENGTH	80"
MATERIAL	Stainless Steel
WEIGHT PER SET	TFEN-S13: 74 lbs. TFEN-S12: 92 lbs.
SOLD	As a Pair
WARRANTY	1 Year

DESIGNED TO FIT **43.5" O.D TIRES**

Trux recommends installing with Mounting Kits that are the SAME OR THICKER Gauge than the fender.  
 TFEN-S13: **TFEN-SKIT, TFEN-SKITN or TFEN-SKITHD** (Page 172) TFEN-S12: **TFEN-SKITHD** (Page 172)

TFEN-S13  
**16**  
 GAUGE

TFEN-S12  
**14**  
 GAUGE

SOLD AS A  
**PAIR**

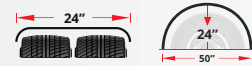
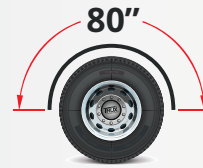

## 80" SMOOTH LOW PROFILE SINGLE AXLE FENDERS



ROLLED EDGE  
**TFEN-S33** 16 Gauge  
**TFEN-S32** 14 Gauge

### TECHNICAL SPECIFICATIONS

FENDER LENGTH	80"
MATERIAL	Stainless Steel
WEIGHT PER SET	TFEN-S33: 74 lbs. TFEN-S32: 92 lbs.
SOLD	As a Pair
WARRANTY	1 Year
DESIGNED TO FIT	<b>41.75" O.D TIRES</b>



TFEN-S33  
**16**  
 GAUGE

TFEN-S32  
**14**  
 GAUGE

SOLD AS A  
**PAIR**

Trux recommends installing with Mounting Kits that are the SAME OR THICKER Gauge than the fender. TFEN-S33: **TFEN-SKIT, TFEN-SKITN, TFEN-SKITHD** (Page 172) TFEN-S32: **TFEN-SKITHD** (Page 172)

## 91" SMOOTH CURVED DROP ROLLIN' LO - SINGLE AXLE FENDERS



ROLLED EDGE  
**TFEN-S11** 14 Gauge

### TECHNICAL SPECIFICATIONS

FENDER LENGTH	91"
MATERIAL	Stainless Steel
WEIGHT PER SET	105 lbs.
SOLD	As a Pair
WARRANTY	1 Year
DESIGNED TO FIT	<b>41.75" O.D TIRES</b>



**14**  
 GAUGE

SOLD AS A  
**PAIR**

Trux recommends installing with Mounting Kits that are the SAME OR THICKER Gauge than the fender. **TFEN-SKITHD** (Page 172)

**WARNING: Cancer and Reproductive Harm - www.p65warnings.ca.gov**

## 80" 3 RIBBED SINGLE AXLE FENDERS



ROLLED EDGE  
**TFEN-S14** 16 Gauge Stainless Steel  
**TFEN-S16** 0.09" Thick Aluminum

### TECHNICAL SPECIFICATIONS

FENDER LENGTH	80"
WEIGHT PER SET	TFEN-S14: 67 lbs TFEN-S16: 39 lbs.
SOLD	As a Pair
WARRANTY	1 Year
DESIGNED TO FIT	<b>43.5" O.D TIRES</b>



**TFEN-S14**  
**16**  
 GAUGE

**TFEN-S16**  
**0.09"**  
 THICKNESS

**SOLD AS A PAIR**

Trux recommends installing with Mounting Kits that are the SAME OR THICKER Gauge than the fender. **TFEN-SKIT, TFEN-SKITN or TFEN-SKITHD** (Page 172)

## 80" 4 RIBBED SINGLE AXLE FENDERS



BEADED EDGE  
**TFEN-S22** 16 Gauge

### TECHNICAL SPECIFICATIONS

FENDER LENGTH	80"
MATERIAL	Stainless Steel
WEIGHT PER SET	70 lbs.
SOLD	As a Pair
WARRANTY	1 Year
DESIGNED TO FIT	<b>43.5" O.D TIRES</b>



**16**  
 GAUGE

**SOLD AS A PAIR**

Trux recommends installing with Mounting Kits that are the SAME OR THICKER Gauge than the fender. **TFEN-SKIT, TFEN-SKITN or TFEN-SKITHD** (Page 172)

## 96" SMOOTH STRAIGHT DROP LOW RIDER - SINGLE AXLE FENDERS



ROLLED EDGE  
**TFEN-S37** 14 Gauge

### TECHNICAL SPECIFICATIONS

FENDER LENGTH	96"
MATERIAL	Stainless Steel
WEIGHT PER SET	110 lbs.
SOLD	As a Pair
WARRANTY	1 Year
DESIGNED TO FIT	<b>43.5" O.D TIRES</b>



**14**  
 GAUGE

**SOLD AS A PAIR**

Trux recommends installing with Mounting Kits that are the SAME OR THICKER Gauge than the fender. **TFEN-SKITHD** (Page 172)

## 96" SMOOTH CURVED DROP ROLLIN' LO - SINGLE AXLE FENDERS



ROLLED EDGE  
**TFEN-S10** 14 Gauge

### TECHNICAL SPECIFICATIONS

FENDER LENGTH	96"
MATERIAL	Stainless Steel
WEIGHT PER SET	110 lbs.
SOLD	As a Pair
WARRANTY	1 Year
DESIGNED TO FIT	<b>43.5" O.D TIRES</b>



**14**  
 GAUGE

**SOLD AS A PAIR**

Trux recommends installing with Mounting Kits that are the SAME OR THICKER Gauge than the fender. **TFEN-SKITHD** (Page 172)

# FENDERS

## ADJUSTABLE FENDER BRACKET HALF FENDER MOUNTING KIT



▲  
THREADED POST MOUNT

**TFEN-HKIT** 14 Gauge (Standard)

**TFEN-HKITHD** 12 Gauge (Heavy Duty)

NON THREADED POST MOUNT

**TFEN-HKITN** 14 Gauge (Standard)

### TECHNICAL SPECIFICATIONS

KIT INCLUDES	2 x Adjustable Fender Brackets 2 x Triangle Mounts (14 or 12 Gauge) 2 x Post Mounts 2 x Clamps & All Hardware
MATERIAL	Stainless Steel
SOLD	As a Kit
WARRANTY	1 Year

OUTFITS  
**1 AXLE**

## SWIVEL FENDER BRACKET HALF FENDER MOUNTING KIT



▲  
THREADED POST MOUNT

**TFEN-HKIT2** 14 Gauge (Standard)

**TFEN-HKIT2HD** 12 Gauge (Heavy Duty)

### TECHNICAL SPECIFICATIONS

KIT INCLUDES	2 x 9" Swivel Fender Brackets 2 x Triangle Mounts (14 or 12 Gauge) 2 x Post Mounts 2 x Clamps & All Hardware
MATERIAL	Stainless Steel
SOLD	As a Kit
WARRANTY	1 Year

OUTFITS  
**1 AXLE**

## ADJUSTABLE FENDER BRACKET FULL FENDER MOUNTING KIT



▲  
THREADED POST MOUNT

**TFEN-FKIT** 14 Gauge (Standard)

**TFEN-FKITHD** 12 Gauge (Heavy Duty)

NON THREADED POST MOUNT

**TFEN-FKITN** 14 Gauge (Standard)

### TECHNICAL SPECIFICATIONS

KIT INCLUDES	2 x Adjustable Fender Brackets 4 x Triangle Mounts (14 or 12 Gauge) 4 x Post Mounts 4 x Clamps & All Hardware
MATERIAL	Stainless Steel
SOLD	As a Kit
WARRANTY	1 Year

OUTFITS  
**1 AXLE**

## SWIVEL FENDER BRACKET FULL FENDER MOUNTING KIT



▲  
THREADED POST MOUNT

**TFEN-FKIT2** 14 Gauge (Standard)

**TFEN-FKIT2HD** 12 Gauge (Heavy Duty)

### TECHNICAL SPECIFICATIONS

KIT INCLUDES	2 x 9" Swivel Fender Brackets 4 x Triangle Mounts (14 or 12 Gauge) 4 x Post Mounts 4 x Clamps & All Hardware
MATERIAL	Stainless Steel
SOLD	As a Kit
WARRANTY	1 Year

OUTFITS  
**1 AXLE**

▲ WARNING: Cancer and Reproductive Harm - www.p65warnings.ca.gov

# TRIANGLE MOUNT SINGLE AXLE FENDER MOUNTING KIT



THREADED POST MOUNT

**TFEN-SKIT** 14 Gauge (Standard)

**TFEN-SKITHD** 12 Gauge (Heavy Duty)

NON THREADED POST MOUNT

**TFEN-SKITN** 14 Gauge (Standard)

**TECHNICAL SPECIFICATIONS**

KIT INCLUDES	4 x Triangle Mounts (14 or 12 Gauge) 4 x Post Mounts 4 x Clamps & All Hardware
--------------	--

MATERIAL	Stainless Steel
SOLD	As a Kit
WARRANTY	1 Year



The swivel mounting bracket is designed for easy installation and avoids any tension that can be encountered when installing. The fender will stay in a neutral state, whereas the bracket can rotate to meet the fender, avoiding any dimples that can lead to a cracked fender!

**Swivel Bracket**  
Rotates to meet the fender

Clockwise or Counter-clockwise

**WARNING:** Cancer and Reproductive Harm - [www.p65warnings.ca.gov](http://www.p65warnings.ca.gov)

# FENDERS

## SWIVEL FENDER BRACKETS

## ADJUSTABLE FENDER BRACKETS



▲ 9" OFFSET  
**TFEN-A54**



▲ 4" OFFSET  
**TFEN-A58**

### TECHNICAL SPECIFICATIONS

KIT INCLUDES	1 x Black Rubber Inset 1 x Top Plate 1 x Back Plate All Hardware
DIMENSIONS	33" x 8" x 4"
DESIGNED TO FIT	Half & Full Fenders
MATERIAL	Steel
SOLD	Individually



▲ DRIVER SIDE  
**TFEN-A29**



▲ PASSENGER SIDE  
**TFEN-A30**

### TECHNICAL SPECIFICATIONS

DESIGNED TO FIT	6" - 8.5" Suspension Height Fits 90% of ALL Truck Suspensions
MATERIAL	Steel
SOLD	Individually
APPLICATION	TFEN-A29: Driver Side TFEN-A30: Passenger Side

## TRIANGLE MOUNT WELDED END CAP



▲ STANDARD 14 GAUGE  
**TFEN-A10** Mount Only  
**TFEN-A11** Mount With Bolt Kit  
**TFEN-A12** Mount With Bolt Kit & Hardware



▲ HEAVY DUTY 12 GAUGE  
**TFEN-A13** Heavy Duty Mount

### TECHNICAL SPECIFICATIONS

	DIMENSIONS	PART NUMBER	TFEN-A10	TFEN-A11	TFEN-A12	TFEN-A13
DIMENSIONS	31" Long					
DESIGNED TO FIT	24" & 26" Wide Fenders					
MATERIAL	Stainless Steel					
SOLD	Individually					
WHAT'S INCLUDED			1 x 14 Ga. Triangle Mount with End Cap	1 x 14 Ga. Triangle Mount with End Cap 1 x Bolt Kit	1 x 14 Ga. Triangle Mount with End Cap 1 x Bolt Kit & Straps	1 x 12 Ga. Triangle Mount with Welded End Cap

▲ WARNING: Cancer and Reproductive Harm - [www.p65warnings.ca.gov](http://www.p65warnings.ca.gov)



# TRIANGLE MOUNT ACCESSORIES

BOLT KIT | METAL PLATE KIT



METAL PLATE  
**TFEN-A38**

**TECHNICAL SPECIFICATIONS**

KIT INCLUDES	1 x Metal Plate
DESIGNED TO FIT	TFEN-A10, TFEN-A11, TFEN-A12 & TFEN-A13
MATERIAL	Metal
SOLD	Individually



BOLT KIT  
**TFEN-A36**

**TECHNICAL SPECIFICATIONS**

KIT INCLUDES	6 x Bolts 6 x Washers
DESIGNED TO FIT	TFEN-A10, TFEN-A11, TFEN-A12 & TFEN-A13
MATERIAL	Metal
SOLD	As a Kit

# POST MOUNT ACCESSORIES



POST MOUNT  
**TFEN-A15** Threaded  
**TFEN-A17** Non Threaded

**TECHNICAL SPECIFICATIONS**

DESIGNED TO FIT	TFEN-A15: TFEN-A44
MATERIAL	Steel
SOLD	Individually



3/4" FINE THREAD BOLT  
**TFEN-A44**

**TECHNICAL SPECIFICATIONS**

DESIGNED TO FIT	TFEN-A15
MATERIAL	Stainless Steel
SOLD	Individually



POST MOUNT CLAMP  
**TFEN-A19**

**TECHNICAL SPECIFICATIONS**

KIT INCLUDES	1 x Bolt 1 x Clamp
MATERIAL	Stainless Steel
SOLD	Individually



WARNING: Cancer and Reproductive Harm - [www.p65warnings.ca.gov](http://www.p65warnings.ca.gov)

# FENDERS

## 24" TUBE MOUNT POLY QUARTER FENDER KIT

**TOP  
SELLER**



ROLLED EDGE  
**TFEN-Q20**

### TECHNICAL SPECIFICATIONS

FENDER LENGTH	24"
MATERIAL	PP / EDPM
WEIGHT PER SET	20 lbs.
SOLD	As a Kit
WARRANTY	1 Year

### KIT INCLUDES

- 2 x Fenders
- 2 x Tube Mounts
- 2 x Clamps
- 2 x Top Mud Flaps & Hardware

### TUBE MOUNT



SOLD AS A  
**KIT**



## 66" HALF TANDEM POLY FENDERS

**TOP  
SELLER**



ROLLED EDGE  
**TFEN-H39**

### TECHNICAL SPECIFICATIONS

FENDER LENGTH	66"
MATERIAL	PP / EDPM
WEIGHT PER SET	24.5 lbs.
SOLD	As a Pair
WARRANTY	1 Year

DESIGNED TO FIT **43.5"/46.5" O.D TIRES**

For Half Tandem Poly Fenders, Trux recommends installing with Mounting Kits: **TFEN-HKITP**, **TFEN-HKITP2** or **TFEN-HKITP3** (Page 177)

SOLD AS A  
**PAIR**

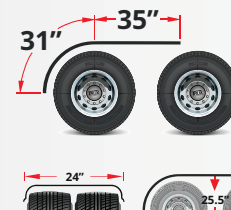

**WARNING:** Cancer and Reproductive Harm - [www.p65warnings.ca.gov](http://www.p65warnings.ca.gov)



## 76" SINGLE AXLE POLY FENDERS

ROLLED EDGE  
**TFEN-S17**

### TECHNICAL SPECIFICATIONS

FENDER LENGTH	76"
MATERIAL	PP / EDPM
WEIGHT PER SET	19.5 lbs.
SOLD	As a Pair
WARRANTY	1 Year

DESIGNED TO FIT **46.5" O.D TIRES**

For Single Axle Poly Fenders, Trux recommends installing with Mounting Kits: **TFEN-SKITP** or **TFEN-SKITP2** (Page 177-178)

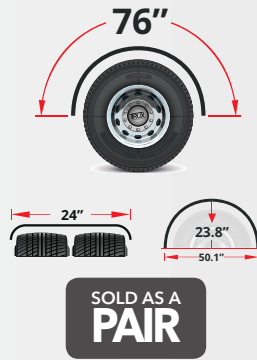

## 133" FULL TANDEM POLY FENDERS

ROLLED EDGE  
**TFEN-F26**

### TECHNICAL SPECIFICATIONS

FENDER LENGTH	133"
MATERIAL	PP / EDPM
WEIGHT PER SET	29 lbs.
SOLD	As a Pair
WARRANTY	1 Year

DESIGNED TO FIT **43.5" O.D TIRES**

For Full Tandem Poly Fenders, Trux recommends installing with Mounting Kits: **TFEN-FKITP**, **TFEN-FKITP2** or **TFEN-FKITP3** (Page 178)

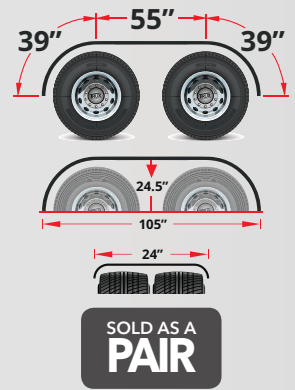

## 105" HALF TANDEM POLY FENDERS

ROLLED EDGE  
**TFEN-H66**

### TECHNICAL SPECIFICATIONS

FENDER LENGTH	105"
MATERIAL	PP / EDPM
WEIGHT PER SET	29 lbs.
SOLD	As a Pair
WARRANTY	1 Year

DESIGNED TO FIT Universal

For Half Tandem Poly Fenders, Trux recommends installing with Mounting Kits: **TFEN-HKITP**, **TFEN-HKITP2** or **TFEN-HKITP3** (Page 177)

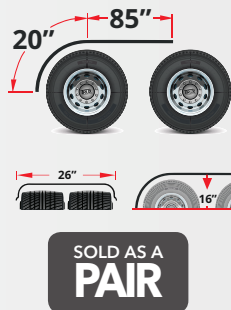

## 105" DOUBLE HUMP POLY FENDERS

ROLLED EDGE  
**TFEN-F40**

### TECHNICAL SPECIFICATIONS

FENDER LENGTH	105"
MATERIAL	PP / EDPM
WEIGHT PER SET	36 lbs.
SOLD	As a Pair
WARRANTY	1 Year

DESIGNED TO FIT **43.5" O.D TIRES**

For Full Tandem Poly Fenders, Trux recommends installing with Mounting Kits: **TFEN-FKITP**, **TFEN-FKITP2** or **TFEN-FKITP3** (Page 178)

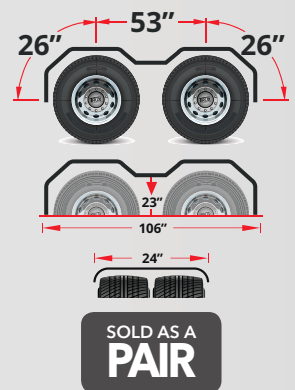

# FENDERS

## ADJUSTABLE FENDER BRACKET HALF FENDER MOUNTING KIT



ADJUSTABLE FENDER BRACKET KIT  
**TFEN-HKITP**

### TECHNICAL SPECIFICATIONS

KIT INCLUDES	2 x Adjustable Fender Brackets 2 x Black Triangle Mounts 2 x Black Threaded Post Mounts 2 x Black Clamps & All Hardware
MATERIAL	Painted Steel
SOLD	As a Kit
WARRANTY	1 Year

OUTFITS  
**1 AXLE**

## SWIVEL FENDER BRACKET HALF FENDER MOUNTING KIT



SWIVEL FENDER BRACKET KIT  
**TFEN-HKITP2**

### TECHNICAL SPECIFICATIONS

KIT INCLUDES	2 x 9" Swivel Fender Brackets 2 x Black Tube Mounts 2 x Black Threaded Post Mounts 2 x Black Clamps & All Hardware
MATERIAL	Painted Steel
SOLD	As a Kit
WARRANTY	1 Year

OUTFITS  
**1 AXLE**

## ANGLED FENDER BRACKET HALF FENDER MOUNTING KIT



ANGLED FENDER BRACKET KIT  
**TFEN-HKITP3**

### TECHNICAL SPECIFICATIONS

KIT INCLUDES	2 x Black Mounting Brackets 2 x Black Tube Mounts 2 x Black Threaded Post Mounts 2 x Black Clamps & All Hardware
MATERIAL	Painted Steel
SOLD	As a Kit
WARRANTY	1 Year

OUTFITS  
**1 AXLE**

## TRIANGLE MOUNTS SINGLE AXLE FENDER MOUNTING KIT



TRIANGLE MOUNT KIT  
**TFEN-SKITP**

### TECHNICAL SPECIFICATIONS

KIT INCLUDES	4 x Black Triangle Mounts 4 x Black Threaded Post Mounts 4 x Black Clamps & All Hardware
MATERIAL	Painted Steel
SOLD	As a Kit
WARRANTY	1 Year

OUTFITS  
**1 AXLE**

## TUBE MOUNTS SINGLE AXLE FENDER MOUNTING KIT



**TOP SELLER**  
TUBE MOUNT KIT  
**TFEN-SKITP2**

**TECHNICAL SPECIFICATIONS**

KIT INCLUDES	4 x Black Tube Mounts 4 x Black Threaded Post Mounts 4 x Black Clamps & All Hardware
MATERIAL	Painted Steel
SOLD	As a Kit
WARRANTY	1 Year

OUTFITS  
**1 AXLE**

## ADJUSTABLE FENDER BRACKET FULL FENDER MOUNTING KIT



ADJUSTABLE FENDER BRACKET KIT  
**TFEN-FKITP**

**TECHNICAL SPECIFICATIONS**

KIT INCLUDES	2 x Adjustable Fender Brackets 4 x Black Triangle Mounts 4 x Black Threaded Post Mounts 4 x Black Clamps & All Hardware
MATERIAL	Painted Steel
SOLD	As a Kit
WARRANTY	1 Year

OUTFITS  
**1 AXLE**

## SWIVEL FENDER BRACKET FULL FENDER MOUNTING KIT

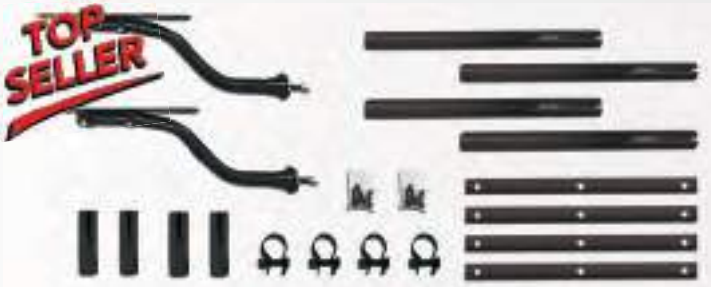

**TOP SELLER**  
SWIVEL FENDER BRACKET KIT  
**TFEN-FKITP2**

**TECHNICAL SPECIFICATIONS**

KIT INCLUDES	2 x 9" Swivel Fender Brackets 4 x Black Tube Mounts 4 x Black Threaded Post Mounts 4 x Black Clamps & All Hardware
MATERIAL	Painted Steel
SOLD	As a Kit
WARRANTY	1 Year

OUTFITS  
**1 AXLE**

## ANGLED FENDER BRACKET FULL FENDER MOUNTING KIT



ANGLED FENDER BRACKET KIT  
**TFEN-FKITP3**

**TECHNICAL SPECIFICATIONS**

KIT INCLUDES	2 x Black Mounting Brackets 4 x Black Tube Mounts 4 x Black Threaded Post Mounts 4 x Black Clamps & All Hardware
MATERIAL	Painted Steel
SOLD	As a Kit
WARRANTY	1 Year

OUTFITS  
**1 AXLE**

# FENDERS

## SWIVEL FENDER BRACKETS



▲ 9" OFFSET  
**TFEN-A54**



▲ 4" OFFSET  
**TFEN-A58**

### TECHNICAL SPECIFICATIONS

KIT INCLUDES	1 x Black Rubber Inset 1 x Top Plate 1 x Back Plate All Hardware
DIMENSIONS	33" x 8" x 4"
DESIGNED TO FIT	Half & Full Fenders
MATERIAL	Steel
SOLD	Individually

## ADJUSTABLE FENDER BRACKETS



▲ DRIVER SIDE  
**TFEN-A29**



▲ PASSENGER SIDE  
**TFEN-A30**

### TECHNICAL SPECIFICATIONS

DESIGNED TO FIT	6" - 8.5" Suspension Height Fits 90% of ALL Truck Suspensions
MATERIAL	Steel
SOLD	Individually
APPLICATION	TFEN-A29: Driver Side TFEN-A30: Passenger Side

## ANGLED FENDER BRACKETS



▲ DRIVER SIDE  
**TFEN-A63**



▲ PASSENGER SIDE  
**TFEN-A64**

### TECHNICAL SPECIFICATIONS

DESIGNED TO FIT	6" - 8.5" Suspension Height
MATERIAL	Steel
SOLD	Individually
WARRANTY	1 Year

▲ WARNING: Cancer and Reproductive Harm - [www.p65warnings.ca.gov](http://www.p65warnings.ca.gov)

## TUBE MOUNT STAINLESS STEEL



▲  
TUBE MOUNT WITH CLAMP & POST MOUNT SET  
**TFEN-A55**

### TECHNICAL SPECIFICATIONS

KIT INCLUDES	1 x Black Tube Mount 1 x Post Mount 1 x Black Clamp All Hardware
MATERIAL	Black Stainless Steel
SOLD	Kit
WARRANTY	1 Year

## TRIANGLE MOUNT WITH BOLT KIT



▲  
TRIANGLE MOUNT WITH BOLT KIT  
**TFEN-A53**

### TECHNICAL SPECIFICATIONS

KIT INCLUDES	1 x Black Triangle Mount with Welded End Cap 6 x Bolts 6 x Washer
ARM GAUGE	14 Gauge
DIMENSIONS	29" Long
MATERIAL	Black Stainless Steel
SOLD	Individually
WARRANTY	1 Year

# JOIN TRUX'S POLY FENDER PROGRAM AND RECIEVE A FREE DISPLAY!

CONTACT YOUR TRUX ACCOUNT MANAGER TODAY!



**STARTER**  
**TRX-173**

'STARTER' FENDER DISPLAY  
RETAIL SPACE: 36" X 24" X 47"



**STANDARD**  
**TRX-172**

'STANDARD' FENDER DISPLAY  
RETAIL SPACE: 36" X 48" X 51"

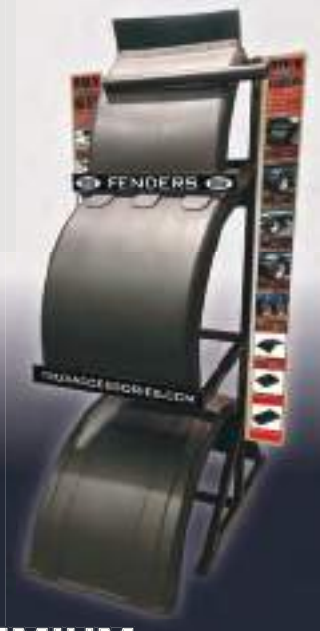

**PREMIUM**  
**TRX-112**

'PREMIUM' FENDER DISPLAY  
RETAIL SPACE: 43" x 48" x 92"

# EXHAUST

## COMPLETE 8" / 7" / 6" DIAMETER KITS

52" MIDDLE SPOOLS - 90° ELBOWS - PRE-2007 PETERBILT MODELS

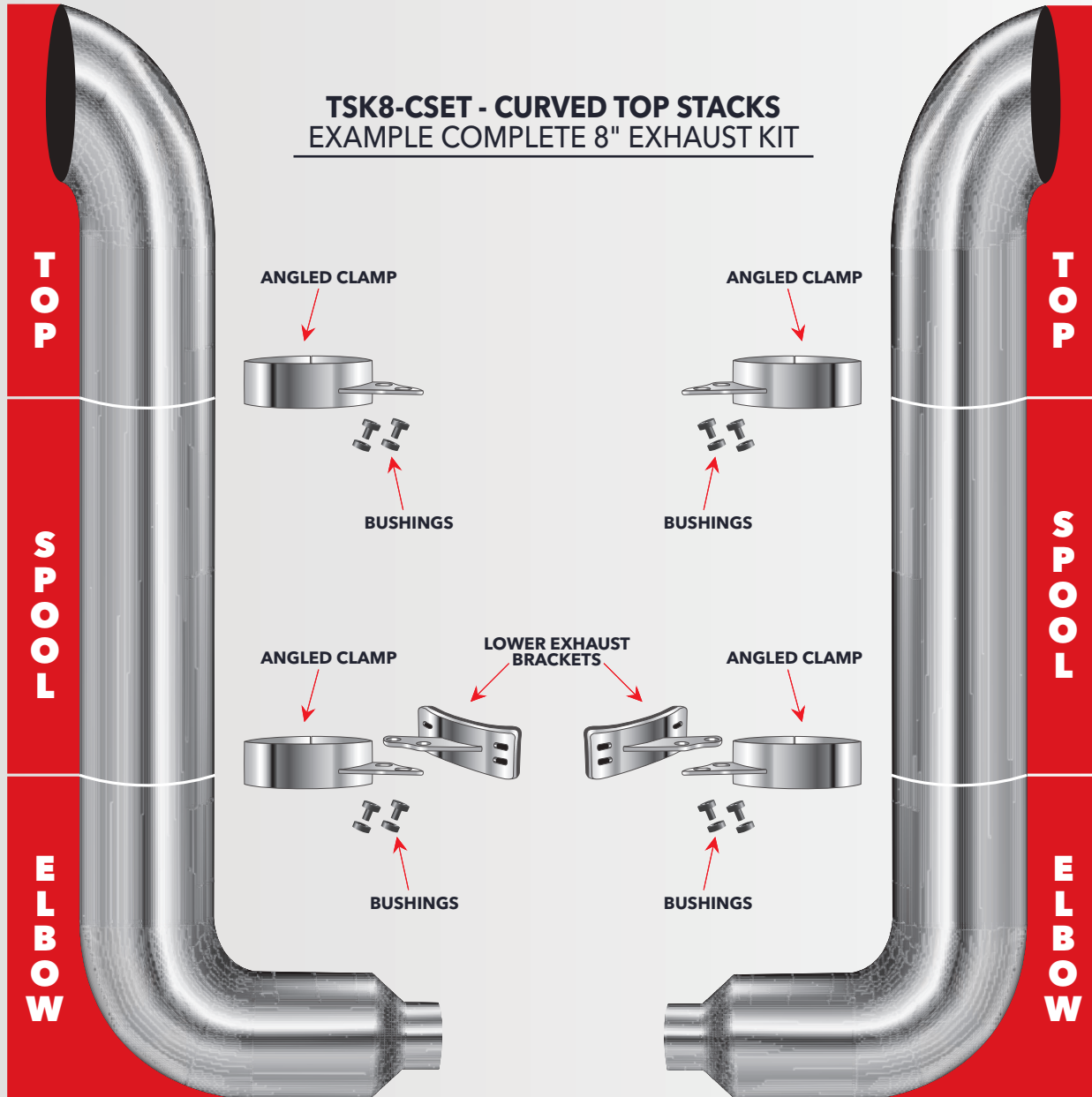

**TSK8-CSET - CURVED TOP STACKS**  
EXAMPLE COMPLETE 8" EXHAUST KIT

### TECHNICAL SPECIFICATIONS

MATERIAL	Chrome Plated Stainless Steel
SOLD	As a Kit
WARRANTY	1 Year

### ALL 8" / 7" / 6" KITS INCLUDE

- 2 x Top Stacks (54" or 60" High)
- 2 x Middle Spools (52" High)
- 2 x 90° Elbows (Reduced to 5" O.D)
- 4 x 3.75" Angled Wide Band & Clamps
- 2 x Angled Lower Exhaust Brackets
- 8 x Black Bushings

### 90° ELBOWS REDUCED TO 5"

All 8"/7"/6" Elbows are Reduced to 5" Diameter in order to be used with the 5" Y-Pipe.

Clamps are Chrome Plated Stainless Steel, allowing the clamps to have the same mirror shine finish as the exhaust components.

 **WARNING:** Cancer and Reproductive Harm - [www.p65warnings.ca.gov](http://www.p65warnings.ca.gov)



**54" / 60" TOP STACK KITS - 52" MIDDLE SPOOLS**  
 90° ELBOWS REDUCED TO 5" - PRE-2007 PETERBILT MODELS



<b>8"</b> DIAMETER KITS	<b>TSK8-MSET</b> 54" Mitered Top Stacks	<b>TSK8-CSET</b> 54" Curved Top Stacks	<b>TSK8-BSET</b> 54" Bullhorn Top Stacks	<b>TSK8-FSET</b> 54" Flat Top Stacks
	<b>TSK8-MSET2</b> 60" Mitered Top Stacks	<b>TSK8-CSET2</b> 60" Curved Top Stacks	<b>TSK8-BSET2</b> 60" Bullhorn Top Stacks	<b>TSK8-FSET2</b> 60" Flat Top Stacks

<b>7"</b> DIAMETER KITS	<b>TSK7-MSET</b> 54" Mitered Top Stacks	<b>TSK7-CSET</b> 54" Curved Top Stacks	<b>TSK7-BSET</b> 54" Bullhorn Top Stacks	Part Not Available
	<b>TSK7-MSET2</b> 60" Mitered Top Stacks	<b>TSK7-CSET2</b> 60" Curved Top Stacks	<b>TSK7-BSET2</b> 60" Bullhorn Top Stacks	Part Not Available

<b>6"</b> DIAMETER KITS	<b>TSK6-MSET</b> 54" Mitered Top Stacks	<b>TSK6-CSET</b> 54" Curved Top Stacks	<b>TSK6-BSET</b> 54" Bullhorn Top Stacks	Part Not Available
	<b>TSK6-MSET2</b> 60" Mitered Top Stacks	<b>TSK6-CSET2</b> 60" Curved Top Stacks	<b>TSK6-BSET2</b> 60" Bullhorn Top Stacks	Part Not Available



WARNING: Cancer and Reproductive Harm - [www.p65warnings.ca.gov](http://www.p65warnings.ca.gov)

# EXHAUST

## COMPLETE 8" / 7" / 6" DIAMETER KITS

55" MIDDLE SPOOLS - 90° ELBOWS - PRE-2007 PETERBILT MODELS

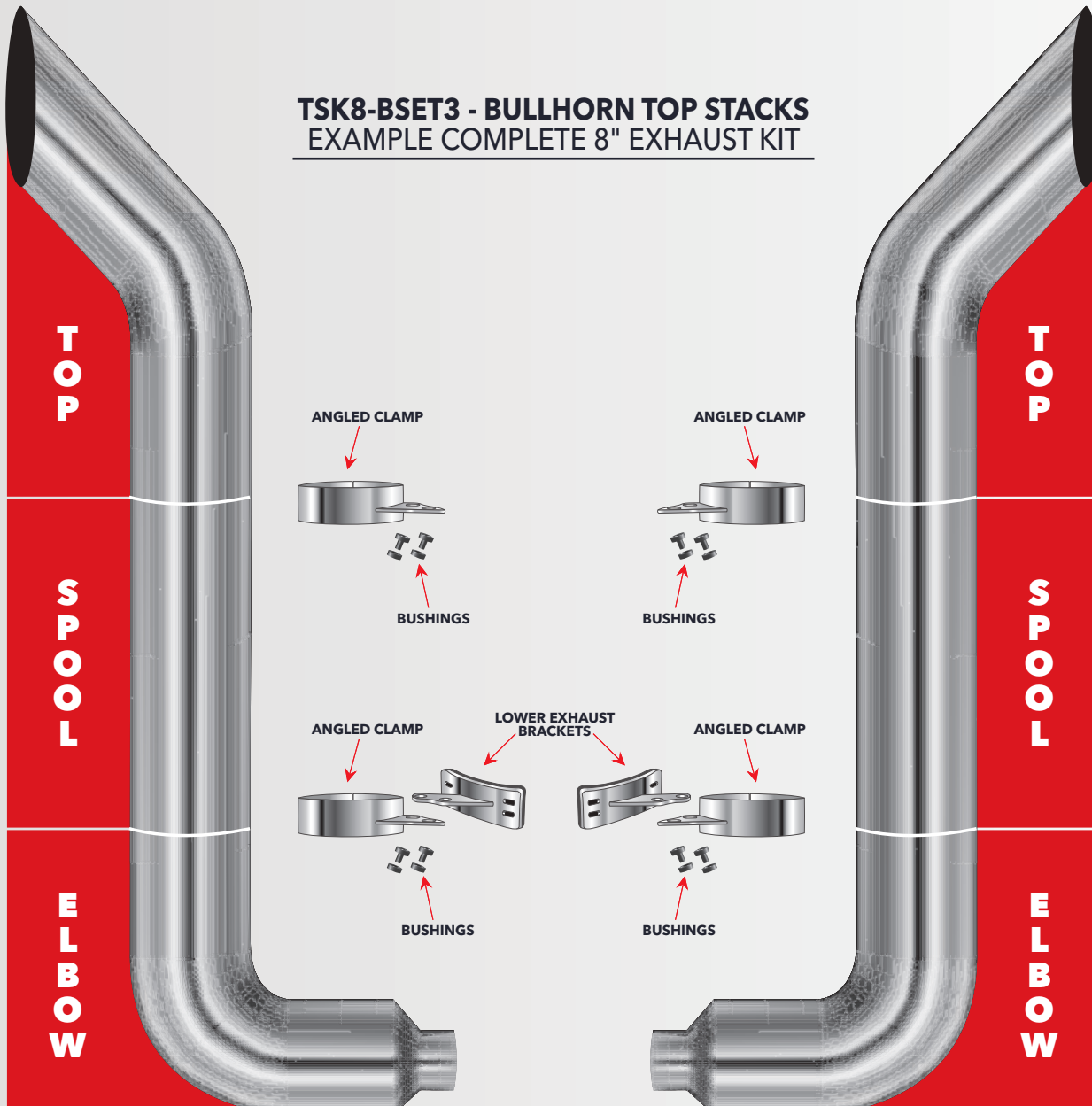

**TSK8-BSET3 - BULLHORN TOP STACKS**  
**EXAMPLE COMPLETE 8" EXHAUST KIT**

### TECHNICAL SPECIFICATIONS

MATERIAL	Chrome Plated Stainless Steel
SOLD	As a Kit
WARRANTY	1 Year

### ALL 8" / 7" / 6" KITS INCLUDE

- 2 x Top Stacks (54" or 60" High)
- 2 x Middle Spools (55" High)
- 2 x 90° Elbows (Reduced to 5" O.D.)
- 4 x 3.75" Angled Wide Band & Clamps
- 2 x Angled Lower Exhaust Brackets
- 8 x Black Bushings

### 90° ELBOWS REDUCED TO 5"

All 8"/7"/6" Elbows are Reduced to 5" Diameter in order to be used with the 5" Y-Pipe.

Clamps are Chrome Plated Stainless Steel, allowing the clamps to have the same mirror shine finish as the exhaust components.

 **WARNING:** Cancer and Reproductive Harm - [www.p65warnings.ca.gov](http://www.p65warnings.ca.gov)

**54" / 60" TOP STACK KITS - 55" MIDDLE SPOOLS**  
 90° ELBOWS REDUCED TO 5" - PRE-2007 PETERBILT MODELS

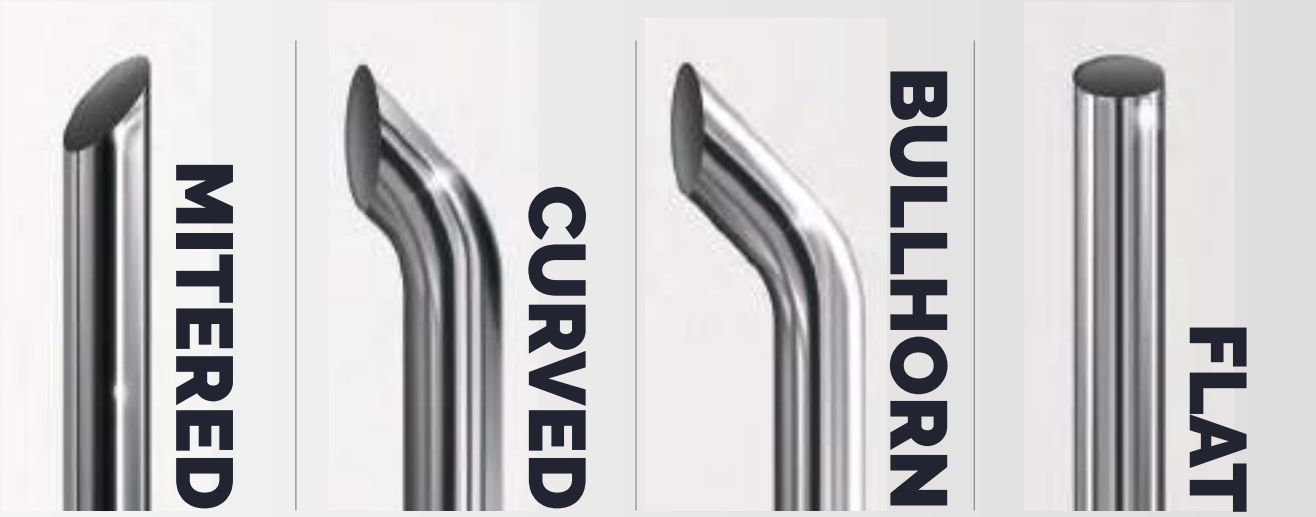

<b>8"</b> DIAMETER KITS	<b>TSK8-MSET5</b> 54" Mitered Top Stacks	<b>TSK8-CSET4</b> 54" Curved Top Stacks	<b>TSK8-BSET3</b> 54" Bullhorn Top Stacks	<b>TSK8-FSET4</b> 54" Flat Top Stacks
	<b>TSK8-MSET3</b> 60" Mitered Top Stacks	<b>TSK8-CSET3</b> 60" Curved Top Stacks	<b>TSK8-BSET4</b> 60" Bullhorn Top Stacks	<b>TSK8-FSET5</b> 60" Flat Top Stacks

<b>7"</b> DIAMETER KITS	<b>TSK7-MSET6</b> 54" Mitered Top Stacks	<b>TSK7-CSET6</b> 54" Curved Top Stacks	<b>TSK7-BSET5</b> 54" Bullhorn Top Stacks	Part Not Available
	<b>TSK7-MSET5</b> 60" Mitered Top Stacks	<b>TSK7-CSET5</b> 60" Curved Top Stacks	<b>TSK7-BSET6</b> 60" Bullhorn Top Stacks	Part Not Available

<b>6"</b> DIAMETER KITS	<b>TSK6-MSET5</b> 54" Mitered Top Stacks	<b>TSK6-CSET5</b> 54" Curved Top Stacks	<b>TSK6-BSET5</b> 54" Bullhorn Top Stacks	Part Not Available
	<b>TSK6-MSET6</b> 60" Mitered Top Stacks	<b>TSK6-CSET6</b> 60" Curved Top Stacks	<b>TSK6-BSET6</b> 60" Bullhorn Top Stacks	Part Not Available



WARNING: Cancer and Reproductive Harm - [www.p65warnings.ca.gov](http://www.p65warnings.ca.gov)

# EXHAUST

## COMPLETE 10" DIAMETER KITS

52" / 55" MIDDLE SPOOLS - 90° ELBOWS - PRE-2007 PETERBILT MODELS

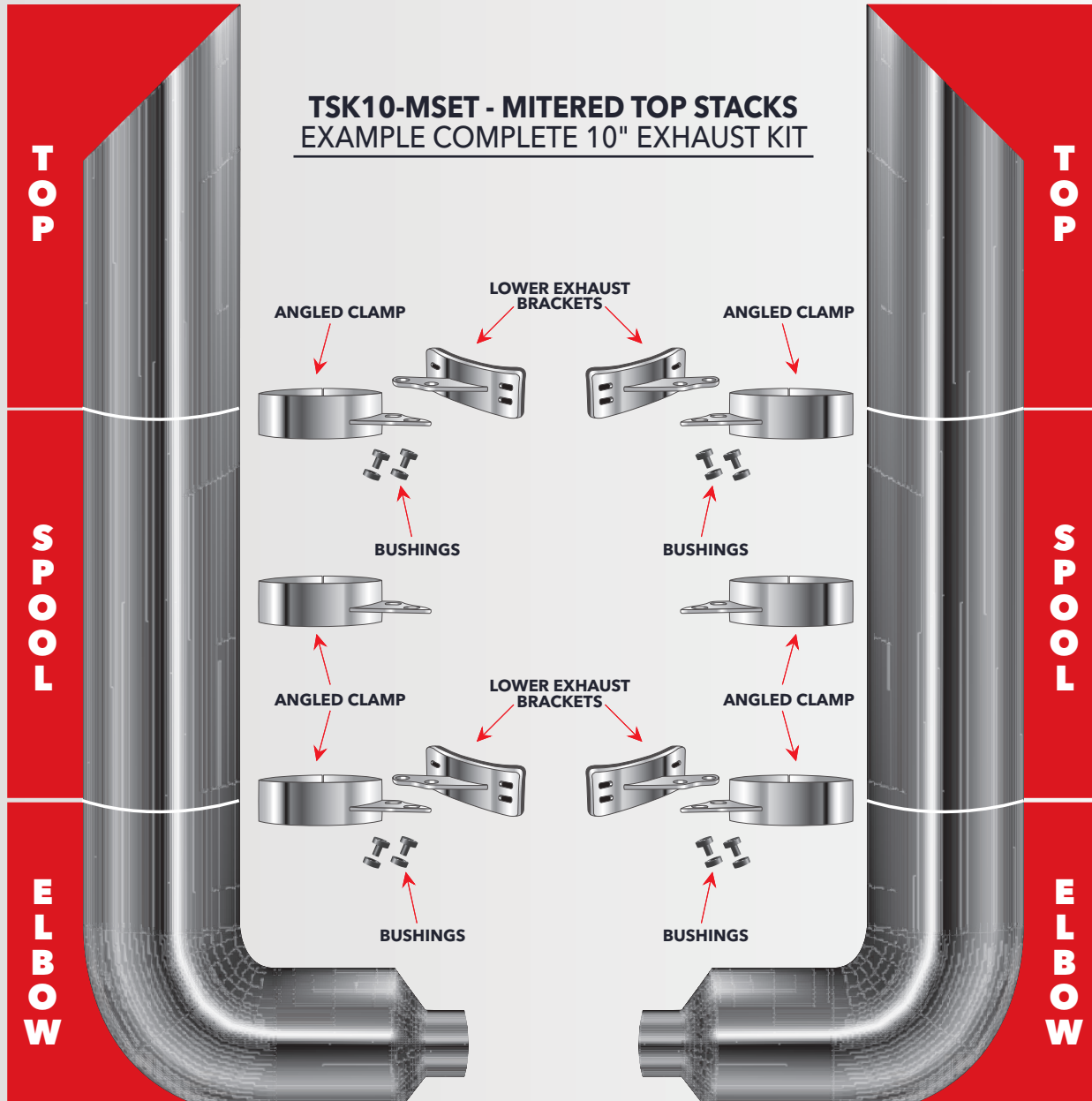

### TECHNICAL SPECIFICATIONS

MATERIAL	Chrome Plated Stainless Steel
SOLD	As a Kit
WARRANTY	1 Year

### ALL 10" KITS INCLUDE

- 2 x Top Stacks (54" or 60" High)
- 2 x Middle Spools (52" or 55" High)
- 2 x 90° Elbows (Reduced to 5" O.D)
- 6 x 3.75" Angled Wide Band & Clamps
- 4 x Angled Lower Exhaust Brackets
- 8 x Black Bushings

### 90° ELBOWS REDUCED TO 5"

All 10" Elbows are Reduced to 5" Diameter in order to be used with the 5" Y-Pipe.

Clamps are Chrome Plated Stainless Steel, allowing the clamps to have the same mirror shine finish as the exhaust components.

WARNING: Cancer and Reproductive Harm - [www.p65warnings.ca.gov](http://www.p65warnings.ca.gov)

**54" / 60" TOP STACK KITS - 52" MIDDLE SPOOLS**  
 90° ELBOWS REDUCED TO 5" - PRE-2007 PETERBILT MODELS



**10"**  
 DIAMETER  
 KITS

**TSK10-MSET**  
 54" Mitered Top Stacks

**TSK10-CSET**  
 54" Curved Top Stacks

**TSK10-BSET**  
 54" Bullhorn Top Stacks

**TSK10-FSET**  
 54" Flat Top Stacks

**TSK10-MSET2**  
 60" Mitered Top Stacks

**TSK10-CSET2**  
 60" Curved Top Stacks

**TSK10-BSET2**  
 60" Bullhorn Top Stacks

**TSK10-FSET2**  
 60" Flat Top Stacks

**54" / 60" TOP STACK KITS - 55" MIDDLE SPOOLS**  
 90° ELBOWS REDUCED TO 5"



**10"**  
 DIAMETER  
 KITS

**TSK10-MSET3**  
 54" Mitered Top Stacks

**TSK10-CSET3**  
 54" Curved Top Stacks

**TSK10-BSET3**  
 54" Bullhorn Top Stacks

**TSK10-FSET3**  
 54" Flat Top Stacks

**TSK10-MSET4**  
 60" Mitered Top Stacks

**TSK10-CSET4**  
 60" Curved Top Stacks

**TSK10-BSET4**  
 60" Bullhorn Top Stacks

**TSK10-FSET4**  
 60" Flat Top Stacks

# EXHAUST

## COMPLETE 8" / 7" / 6" DIAMETER KITS

52" MIDDLE SPOOLS - 58° ELBOWS - PRE-2007 PETERBILT MODELS

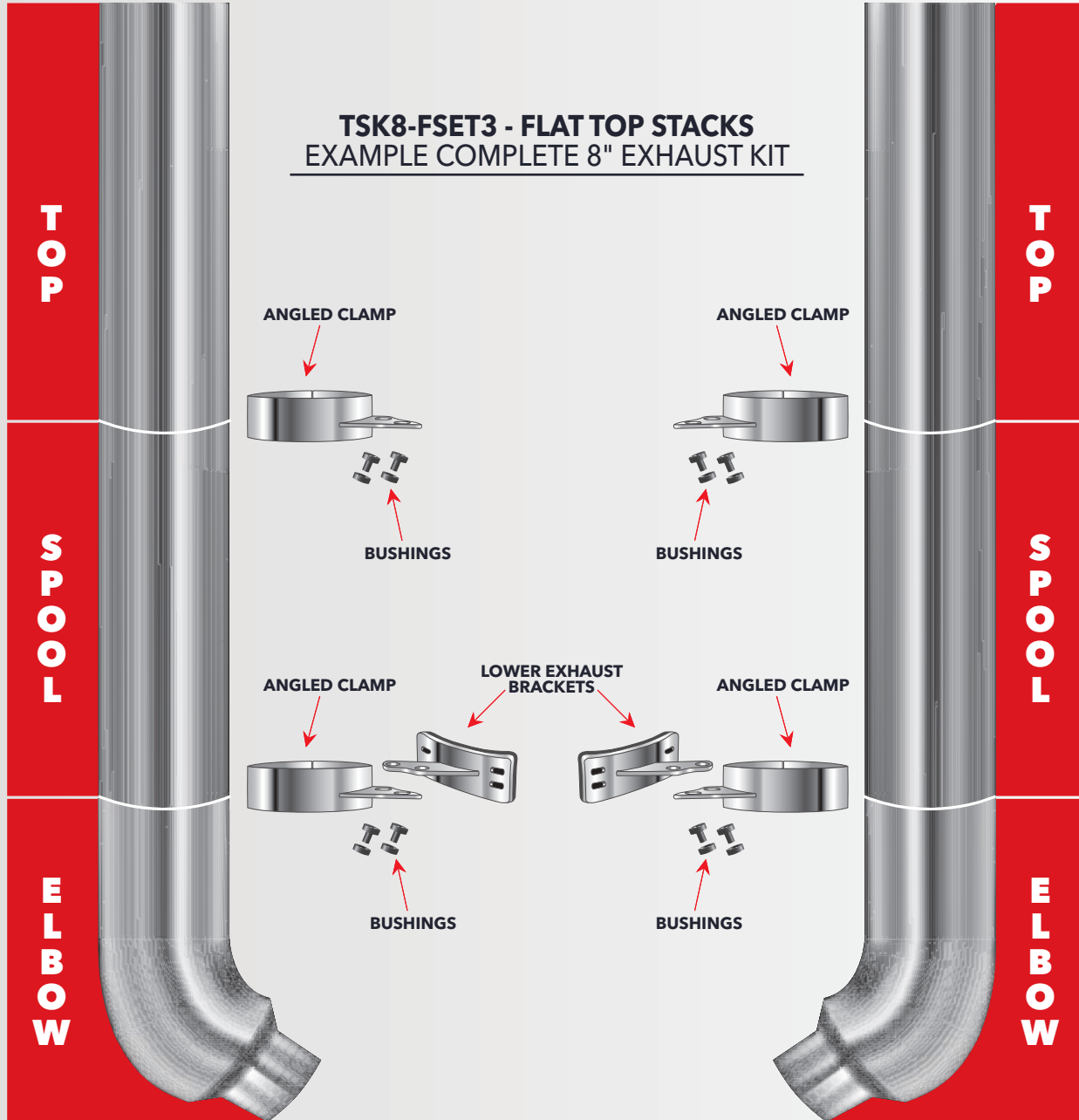

**TSK8-FSET3 - FLAT TOP STACKS**  
EXAMPLE COMPLETE 8" EXHAUST KIT

### TECHNICAL SPECIFICATIONS

MATERIAL	Chrome Plated Stainless Steel
SOLD	As a Kit
WARRANTY	1 Year

### ALL 8" / 7" / 6" KITS INCLUDE

- 2 x Top Stacks (54" or 60" High)
- 2 x Middle Spools (52" High)
- 2 x 58° Elbows (Reduced to 5" O.D)
- 4 x 3.75" Angled Wide Band & Clamps
- 2 x Angled Lower Exhaust Brackets
- 8 x Black Bushings

### 90° ELBOWS REDUCED TO 5"

All 8"/7"/6" Elbows are Reduced to 5" Diameter in order to be used with the 5" Y-Pipe.

Clamps are Chrome Plated Stainless Steel, allowing the clamps to have the same mirror shine finish as the exhaust components.

WARNING: Cancer and Reproductive Harm - [www.p65warnings.ca.gov](http://www.p65warnings.ca.gov)

**54" / 60" TOP STACK KITS - 52" MIDDLE SPOOLS**  
 58° ELBOWS REDUCED TO 5" - PRE-2007 PETERBILT MODELS



<b>8"</b> DIAMETER KITS	<b>TSK8-MSET4</b> 54" Mitered Top Stacks	<b>TSK8-CSET5</b> 54" Curved Top Stacks	<b>TSK8-BSET5</b> 54" Bullhorn Top Stacks	<b>TSK8-FSET3</b> 54" Flat Top Stacks
	<b>TSK8-MSET6</b> 60" Mitered Top Stacks	<b>TSK8-CSET6</b> 60" Curved Top Stacks	<b>TSK8-BSET6</b> 60" Bullhorn Top Stacks	<b>TSK8-FSET6</b> 60" Flat Top Stacks
<b>7"</b> DIAMETER KITS	<b>TSK7-MSET3</b> 54" Mitered Top Stacks	<b>TSK7-CSET3</b> 54" Curved Top Stacks	<b>TSK7-BSET3</b> 54" Bullhorn Top Stacks	Part Not Available
	<b>TSK7-MSET4</b> 60" Mitered Top Stacks	<b>TSK7-CSET4</b> 60" Curved Top Stacks	<b>TSK7-BSET4</b> 60" Bullhorn Top Stacks	Part Not Available
<b>6"</b> DIAMETER KITS	<b>TSK6-MSET3</b> 54" Mitered Top Stacks	<b>TSK6-CSET3</b> 54" Curved Top Stacks	<b>TSK6-BSET3</b> 54" Bullhorn Top Stacks	Part Not Available
	<b>TSK6-MSET4</b> 60" Mitered Top Stacks	<b>TSK6-CSET4</b> 60" Curved Top Stacks	<b>TSK6-BSET4</b> 60" Bullhorn Top Stacks	Part Not Available



**WARNING: Cancer and Reproductive Harm - [www.p65warnings.ca.gov](http://www.p65warnings.ca.gov)**

# EXHAUST

## COMPLETE 8" / 7" / 6" DIAMETER KITS

55" MIDDLE SPOOLS - 58° ELBOWS - PRE-2007 PETERBILT MODELS

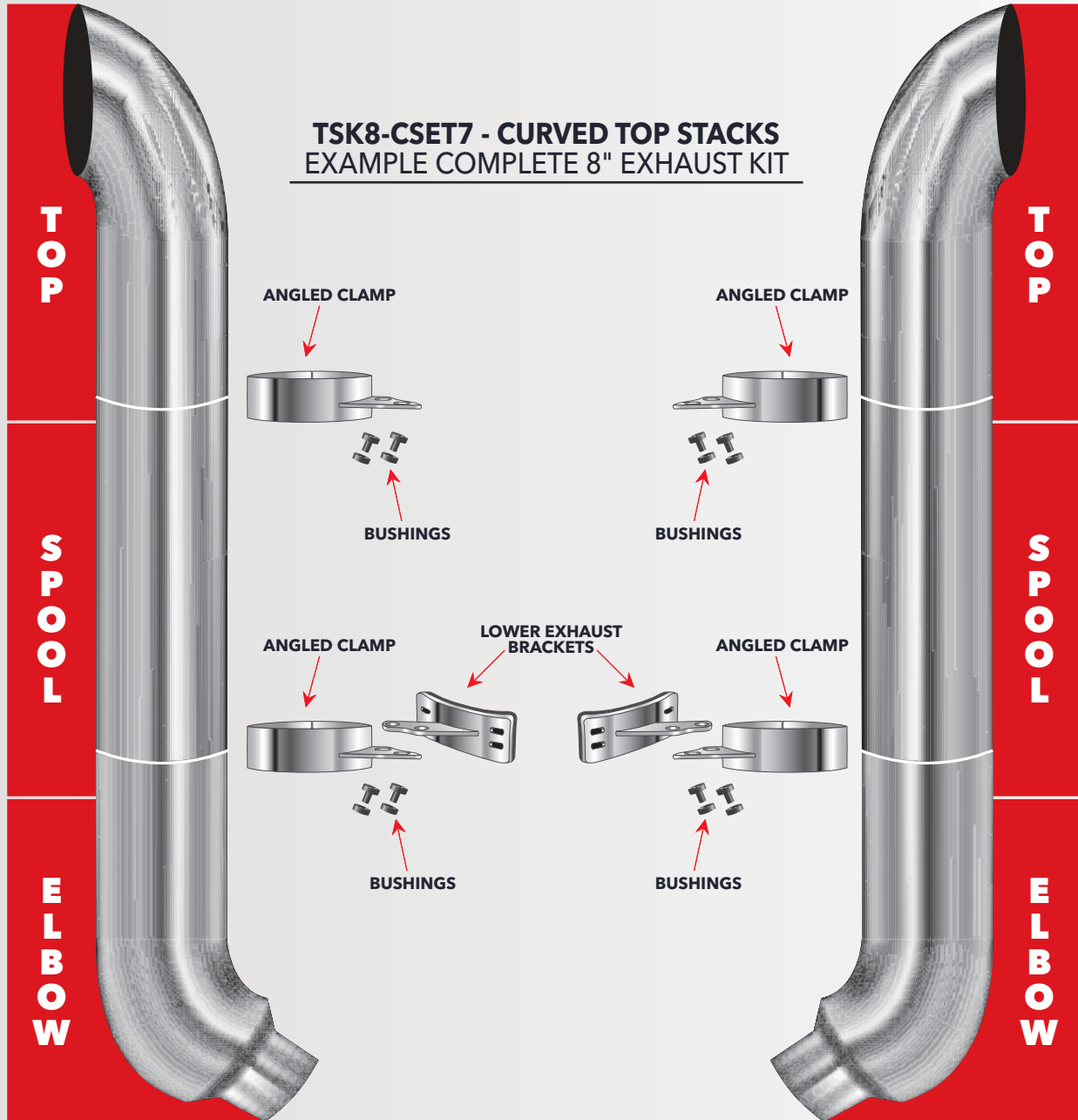

**TSK8-CSET7 - CURVED TOP STACKS**  
EXAMPLE COMPLETE 8" EXHAUST KIT

### TECHNICAL SPECIFICATIONS

MATERIAL	Chrome Plated Stainless Steel
SOLD	As a Kit
WARRANTY	1 Year

### ALL 8" / 7" / 6" KITS INCLUDE

- 2 x Top Stacks (54" or 60" High)
- 2 x Middle Spools (55" High)
- 2 x 58° Elbows (Reduced to 5" O.D)
- 4 x 3.75" Angled Wide Band & Clamps
- 2 x Angled Lower Exhaust Brackets
- 8 x Black Bushings

### 90° ELBOWS REDUCED TO 5"

All 8"/7"/6" Elbows are Reduced to 5" Diameter in order to be used with the 5" Y-Pipe.

Clamps are Chrome Plated Stainless Steel, allowing the clamps to have the same mirror shine finish as the exhaust components.

WARNING: Cancer and Reproductive Harm - [www.p65warnings.ca.gov](http://www.p65warnings.ca.gov)



**54" / 60" TOP STACK KITS - 55" MIDDLE SPOOLS**  
 58° ELBOWS REDUCED TO 5" - PRE-2007 PETERBILT MODELS



<b>8"</b> DIAMETER KITS	<b>TSK8-MSET7</b> 54" Mitered Top Stacks	<b>TSK8-CSET7</b> 54" Curved Top Stacks	<b>TSK8-BSET7</b> 54" Bullhorn Top Stacks	<b>TSK8-FSET7</b> 54" Flat Top Stacks
	<b>TSK8-MSET8</b> 60" Mitered Top Stacks	<b>TSK8-CSET8</b> 60" Curved Top Stacks	<b>TSK8-BSET8</b> 60" Bullhorn Top Stacks	<b>TSK8-FSET8</b> 60" Flat Top Stacks
<b>7"</b> DIAMETER KITS	<b>TSK7-MSET7</b> 54" Mitered Top Stacks	<b>TSK7-CSET7</b> 54" Curved Top Stacks	<b>TSK7-BSET7</b> 54" Bullhorn Top Stacks	Part Not Available
	<b>TSK7-MSET8</b> 60" Mitered Top Stacks	<b>TSK7-CSET8</b> 60" Curved Top Stacks	<b>TSK7-BSET8</b> 60" Bullhorn Top Stacks	Part Not Available
<b>6"</b> DIAMETER KITS	<b>TSK6-MSET7</b> 54" Mitered Top Stacks	<b>TSK6-CSET7</b> 54" Curved Top Stacks	<b>TSK6-BSET7</b> 54" Bullhorn Top Stacks	Part Not Available
	<b>TSK6-MSET8</b> 60" Mitered Top Stacks	<b>TSK6-CSET8</b> 60" Curved Top Stacks	<b>TSK6-BSET8</b> 60" Bullhorn Top Stacks	Part Not Available



**WARNING:** Cancer and Reproductive Harm - [www.p65warnings.ca.gov](http://www.p65warnings.ca.gov)

# EXHAUST

## 54" / 60" TOP STACKS PRE-2007 TRUCK MODELS - SOLD INDIVIDUALLY



<b>10"</b> DIAMETER TOP STACK	<b>TSK10-M54T</b> 54" Mitered Top Stack	<b>TSK10-C54T</b> 54" Curved Top Stack	<b>TSK10-B54T</b> 54" Bullhorn Top Stack	<b>TSK10-F54T</b> 54" Flat Top Stack
	<b>TSK10-M60T</b> 60" Mitered Top Stack	<b>TSK10-C60T</b> 60" Curved Top Stack	<b>TSK10-B60T</b> 60" Bullhorn Top Stack	<b>TSK10-F60T</b> 60" Flat Top Stack
<b>8"</b> DIAMETER TOP STACK	<b>TSK8-M54T</b> 54" Mitered Top Stack	<b>TSK8-C54T</b> 54" Curved Top Stack	<b>TSK8-B54T</b> 54" Bullhorn Top Stack	<b>TSK8-F54T</b> 54" Flat Top Stack
	<b>TSK8-M60T</b> 60" Mitered Top Stack	<b>TSK8-C60T</b> 60" Curved Top Stack	<b>TSK8-B60T</b> 60" Bullhorn Top Stack	<b>TSK8-F60T</b> 60" Flat Top Stack
<b>7"</b> DIAMETER TOP STACK	<b>TSK7-M54T</b> 54" Mitered Top Stack	<b>TSK7-C54T</b> 54" Curved Top Stack	<b>TSK7-B54T</b> 54" Bullhorn Top Stack	Part Not Available
	<b>TSK7-M60T</b> 60" Mitered Top Stack	<b>TSK7-C60T</b> 60" Curved Top Stack	<b>TSK7-B60T</b> 60" Bullhorn Top Stack	Part Not Available
<b>6"</b> DIAMETER TOP STACK	<b>TSK6-M54T</b> 54" Mitered Top Stack	<b>TSK6-C54T</b> 54" Curved Top Stack	<b>TSK6-B54T</b> 54" Bullhorn Top Stack	Part Not Available
	<b>TSK6-M60T</b> 60" Mitered Top Stack	<b>TSK6-C60T</b> 60" Curved Top Stack	<b>TSK6-B60T</b> 60" Bullhorn Top Stack	Part Not Available

**TRUX'S RETAIL PACKAGING**  
INFORMATIVE, EYE-CATCHING RETAIL BOX  
PROTECTING YOUR PURCHASE DURING TRANSIT

ALL OF TRUX'S EXHAUSTS KITS, TOP STACKS, SPOOLS & ACCESSORIES ARE SHIPPED IN HIGH QUALITY PACKAGING FOR YOUR CONVENIENCE

WARNING: Cancer and Reproductive Harm - [www.p65warnings.ca.gov](http://www.p65warnings.ca.gov)

**52" / 55" MIDDLE SPOOLS**  
 PLAIN BOTTOM | REDUCED TO 5" BOTTOM - PRE-2007 TRUCK MODELS - SOLD INDIVIDUALLY



PLAIN BOTTOM	
<b>TSK10-52S</b> 10" Diameter - 52" Middle Spool	<b>TSK10-55S</b> 10" Diameter - 55" Middle Spool
<b>TSK8-52S</b> 8" Diameter - 52" Middle Spool	<b>TSK8-55S</b> 8" Diameter - 55" Middle Spool
<b>TSK7-52S</b> 7" Diameter - 52" Middle Spool	<b>TSK7-55S</b> 7" Diameter - 55" Middle Spool
<b>TSK6-52S</b> 6" Diameter - 52" Middle Spool	<b>TSK6-55S</b> 6" Diameter - 55" Middle Spool

REDUCED TO 5" BOTTOM	
<b>TSK75-52S</b> 7" to 5" Reduced Diameter 52" Middle Spool	<b>TSK75-55S</b> 7" to 5" Reduced Diameter 55" Middle Spool
<b>TSK65-52S</b> 6" to 5" Reduced Diameter 52" Middle Spool	Part Not Available

**IMPORTANT**

For Peterbilt 379: Trucks between 1987-2003, use a 52" Middle Spool. From 2003-2006, use a 55" Middle Spool. (Some Peterbilt 379 Models built in late 2003 may need 52" Middle Spools)

Please measure the distance between your current upper & lower exhaust brackets for exact dimensions.

**Attention! The above measurements are the length of each spool and do not include the additional tapered sleeve. If assembled correctly, the middle spool will measure either 52" or 55" in length.**

**IMPORTANT**

The common 5" Outer Diameter Elbows will fit inside these Middle Spools.

For Peterbilt 379: Trucks between 1987-2003, use a 52" Middle Spool. From 2003-2006, use a 55" Middle Spool.

Please measure the distance between your current upper & lower exhaust brackets for exact dimensions.

**Attention! The above measurements are the length of each spool and do not include the additional tapered sleeve. If assembled correctly, the middle spool will measure either 52" or 55" in length.**



WARNING: Cancer and Reproductive Harm - www.p65warnings.ca.gov

# EXHAUST

## 90° ELBOWS - REDUCED TO 5" O.D PRE-2007 TRUCK MODELS - SOLD INDIVIDUALLY

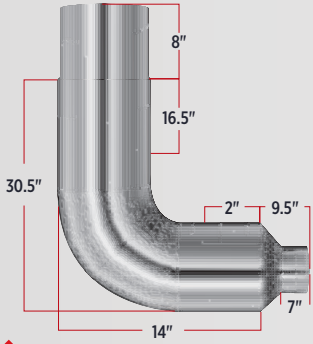

▲ 10" REDUCED TO 5" DIAMETER  
**TEL-105**

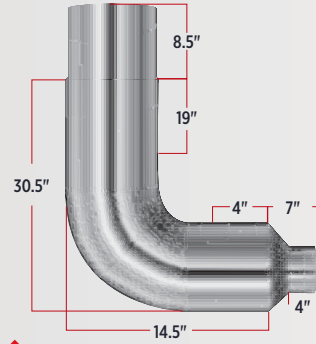

▲ 8" REDUCED TO 5" DIAMETER  
**TEL-85**

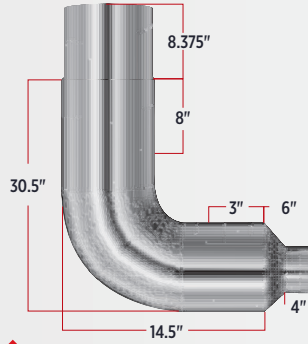

▲ 7" REDUCED TO 5" DIAMETER  
**TEL-75**

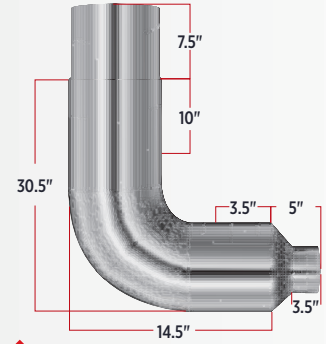

▲ 6" REDUCED TO 5" DIAMETER  
**TEL-65**

### TECHNICAL SPECIFICATIONS

MATERIAL	Chrome Plated Stainless Steel
SOLD	Individually
WARRANTY	1 Year

These elbows are sold with an additional tapered sleeve & is attached to the top of the elbow. This extra reduced sleeve fits INTO the bottom of any middle spool (corresponding to the correct diameter) offering the elbow extra support and strength.

## 90° ELBOWS - REDUCED TO 8" O.D PRE-2007 TRUCK MODELS - SOLD INDIVIDUALLY

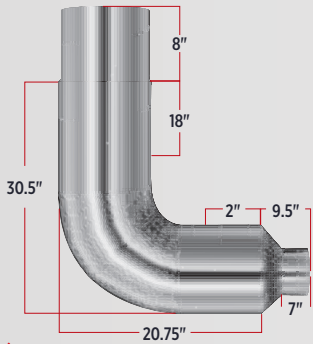

▲ 10" REDUCED TO 8" DIAMETER  
**TEL-10**

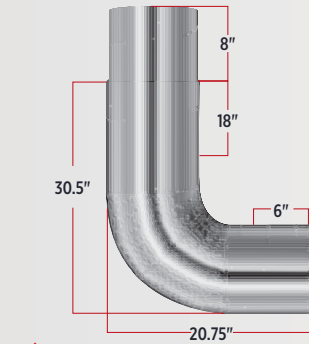

▲ 8" DIAMETER  
**TEL-8**

### TECHNICAL SPECIFICATIONS

MATERIAL	Chrome Plated Stainless Steel
SOLD	Individually
WARRANTY	1 Year

These elbows are sold with an additional tapered sleeve & is attached to the top of the elbow. This extra reduced sleeve fits INTO the bottom of any middle spool (corresponding to the correct diameter) offering the elbow extra support and strength.



▲ WARNING: Cancer and Reproductive Harm - [www.p65warnings.ca.gov](http://www.p65warnings.ca.gov)

# 58° ELBOWS - REDUCED TO 5" O.D

PRE-2007 TRUCK MODELS - SOLD INDIVIDUALLY

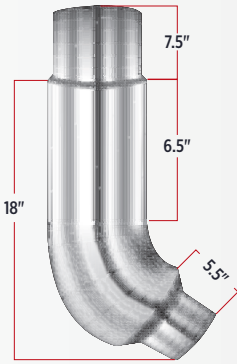

▲ 8" REDUCED TO 5" DIAMETER  
**TEL85-PET**

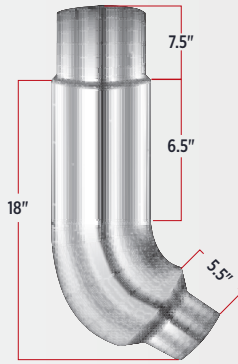

▲ 7" REDUCED TO 5" DIAMETER  
**TEL75-PET**

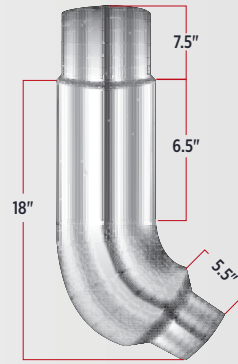

▲ 6" REDUCED TO 5" DIAMETER  
**TEL65-PET**



▲ 5" DIAMETER  
**TEL55-PET**

**TECHNICAL SPECIFICATIONS**

MATERIAL	Chrome Plated Stainless Steel
SOLD	Individually
WARRANTY	1 Year

These elbows are sold with an additional tapered sleeve & is attached to the top of the elbow. This extra reduced sleeve fits INTO the bottom of any middle spool (corresponding to the correct diameter) offering the elbow extra support and strength.



▲ WARNING: Cancer and Reproductive Harm - [www.p65warnings.ca.gov](http://www.p65warnings.ca.gov)

# EXHAUST

## 5" O.D TOP STACKS PRE-2007 TRUCK MODELS - SOLD INDIVIDUALLY

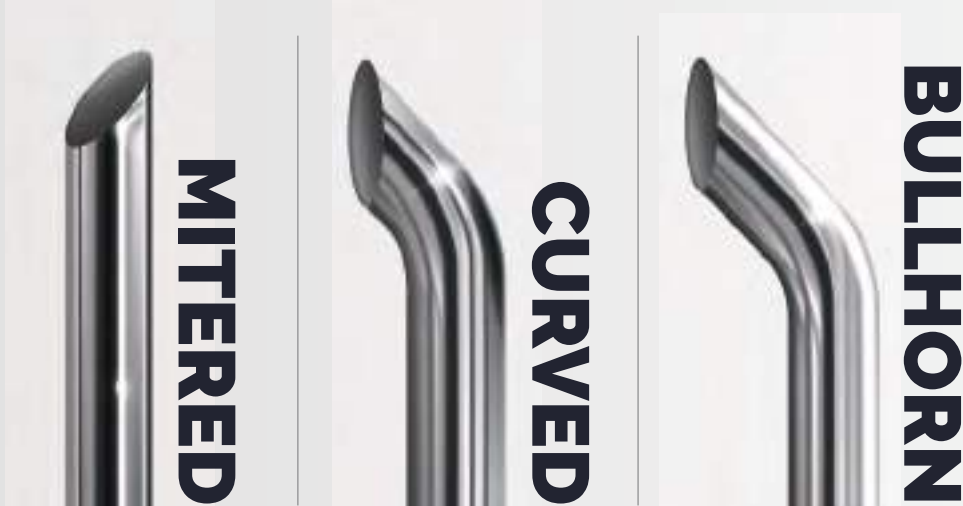

**36"**  
LONG

**TSK5-M036**  
36" Mitered Top Stack

**TSK5-C036**  
36" Curved Top Stack

**TSK5-B036**  
36" Bullhorn Top Stack

**48"**  
LONG

**TSK5-M048**  
48" Mitered Top Stack

**TSK5-C048**  
48" Curved Top Stack

**TSK5-B048**  
48" Bullhorn Top Stack

**60"**  
LONG

**TSK5-M060**  
60" Mitered Top Stack

**TSK5-C060**  
60" Curved Top Stack

**TSK5-B060**  
60" Bullhorn Top Stack



### TECHNICAL SPECIFICATIONS

MATERIAL	Chrome Plated Stainless Steel
SOLD	Individually
WARRANTY	1 Year



WARNING: Cancer and Reproductive Harm - [www.p65warnings.ca.gov](http://www.p65warnings.ca.gov)

# REDUCED TO 5" O.D TOP STACKS

PRE-2007 TRUCK MODELS - SOLD INDIVIDUALLY



**7" TO 5" REDUCED**

<b>TSK75-M048</b> 7" to 5" Reduced Diameter 48" Mitered Top Stack	<b>TSK75-C048</b> 7" to 5" Reduced Diameter 48" Curved Top Stack	<b>TSK75-B048</b> 7" to 5" Reduced Diameter 48" Bullhorn Top Stack
<b>TSK75-M060</b> 7" to 5" Reduced Diameter 60" Mitered Top Stack	<b>TSK75-C060</b> 7" to 5" Reduced Diameter 60" Curved Top Stack	<b>TSK75-B060</b> 7" to 5" Reduced Diameter 60" Bullhorn Top Stack



**6" TO 5" REDUCED**

<b>TSK65-M036</b> 6" to 5" Reduced Diameter 36" Mitered Top Stack	<b>TSK65-C036</b> 6" to 5" Reduced Diameter 36" Curved Top Stack	<b>TSK65-B036</b> 6" to 5" Reduced Diameter 36" Bullhorn Top Stack
<b>TSK65-M048</b> 6" to 5" Reduced Diameter 48" Mitered Top Stack	<b>TSK65-C048</b> 6" to 5" Reduced Diameter 48" Curved Top Stack	<b>TSK65-B048</b> 6" to 5" Reduced Diameter 48" Bullhorn Top Stack
<b>TSK65-M060</b> 6" to 5" Reduced Diameter 60" Mitered Top Stack	<b>TSK65-C060</b> 6" to 5" Reduced Diameter 60" Curved Top Stack	<b>TSK65-B060</b> 6" to 5" Reduced Diameter 60" Bullhorn Top Stack



**TECHNICAL SPECIFICATIONS**

MATERIAL	Chrome Plated Stainless Steel
SOLD	Individually
WARRANTY	1 Year



**TRUX'S RETAIL PACKAGING**  
INFORMATIVE, EYE-CATCHING RETAIL BOX  
PROTECTING YOUR PURCHASE DURING TRANSIT

ALL OF TRUX'S EXHAUSTS KITS, TOP STACKS, SPOOLS & ACCESSORIES ARE SHIPPED IN HIGH QUALITY PACKAGING FOR YOUR CONVENIENCE

 WARNING: Cancer and Reproductive Harm - [www.p65warnings.ca.gov](http://www.p65warnings.ca.gov)

# EXHAUST

## LOWER EXHAUST BRACKETS STRAIGHT | ANGLED



STRAIGHT BRACKET  
**TCLA-PEB**



ANGLED BRACKET  
**TCLA-PEBA**

### TECHNICAL SPECIFICATIONS

MATERIAL	Chrome Plated Stainless Steel
SOLD	Individually
WARRANTY	1 Year

Replaces the original Exhaust Bracket on the Cab corner.

## BRACKET BUSHINGS 4 UNITS



4 PACK  
**TP-2010**

### TECHNICAL SPECIFICATIONS

MATERIAL	Black Polyurethane
SOLD	Pack of 4
WARRANTY	1 Year

## WIDE BAND CLAMPS STRAIGHT / ANGLED MOUNTING PLATE



STRAIGHT MOUNTING PLATE  
**TCLA-51** 5" Wide  
**TCLA-61** 6" Wide



ANGLED MOUNTING PLATE  
**TCLA-103** 10" Wide  
**TCLA-83** 8" Wide  
**TCLA-73** 7" Wide  
**TCLA-63** 6" Wide

### TECHNICAL SPECIFICATIONS

MATERIAL	Chrome Plated Stainless Steel
SOLD	Individually
WARRANTY	1 Year

The clamp wraps around the Exhaust & attaches to the Mounting Bracket of the truck.



## Y-PIPE FOR TRUX ELBOWS



GALVANIZED STEEL  
**TSK-5Y** 5" Wide  
**TSK-8Y** 8" Wide

### TECHNICAL SPECIFICATIONS

MATERIAL	Galvanized Steel
SOLD	Individually
WARRANTY	1 Year

<b>TSK-5Y</b> DESIGNED TO FIT	Trux Elbows: TEL85-PET, TEL75-PET, TEL65-PET, TEL55-PET, TEL-105, TEL-85, TEL-75, TEL-65
<b>TSK-8Y</b> DESIGNED TO FIT	Trux Elbows: TEL-8 & TEL-10

WARNING: Cancer and Reproductive Harm - [www.p65warnings.ca.gov](http://www.p65warnings.ca.gov)



**COMPLETE EXHAUST HARDWARE KITS**  
ALL-IN-ONE BOX OUTFITS ONE TRUCK



**ALL-IN-ONE  
BOX!**

**NO MORE LOOSE PARTS TO WORRY ABOUT!**  
THE TRUX ALL-IN-ONE BOX TAKES CARE  
OF YOUR INVENTORY NEEDS.



**WIDE BAND CLAMPS**  
(ANGLED OR STRAIGHT)

**BRACKET BUSHINGS**

**LOWER EXHAUST BRACKETS**  
(ANGLED OR STRAIGHT)

**TECHNICAL SPECIFICATIONS**

SOLD	As a Kit
WARRANTY	1 Year

PART NUMBER	TSK10K	TSK8K	TSK7K	TSK6K	TSK5K
KIT INCLUDES	6 x 10" Angled Wide Band Clamps 4 x Angled Lower Exhaust Brackets 8 x Bracket Bushings	4 x 8" Angled Wide Band Clamps 2 x Angled Lower Exhaust Brackets 8 x Bracket Bushings	4 x 7" Angled Wide Band Clamps 2 x Angled Lower Exhaust Brackets 8 x Bracket Bushings	4 x 6" Angled Wide Band Clamps 2 x Angled Lower Exhaust Brackets 8 x Bracket Bushings	4 x 5" Straight Wide Band Clamps 2 x Straight Lower Exhaust Brackets 8 x Bracket Bushings

**WARNING:** Cancer and Reproductive Harm - [www.p65warnings.ca.gov](http://www.p65warnings.ca.gov)

# PETERBILT SUN VISORS

## 14" BOWTIE HIGH & LOW ROOF SUN VISORS



SOUTHERN STYLE  
**TSUN-P1** Stainless Steel  
**TSUN-P2** Paintable Aluminium

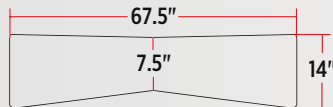

### TECHNICAL SPECIFICATIONS

#### HIGH & LOW ROOF MODELS

**379 & 378** (2005-2007) **389, 388, 386, 385, 384, 357, 340, 335 & 330** (2007+)

DIMENSIONS	Width: 67.5"   Sides: 14"   Drop: 7.5"
WHAT'S INCLUDED	1 x Sun Visor Bracket & Hardware
WARRANTY	1 Year

Visit our website at [www.truxaccessories.com](http://www.truxaccessories.com) for Installation Instructions. Drilling will be required. For Trucks with Cab/Door Mounted Mirrors.

## 14" BOLTLESS HIGH ROOF SUN VISOR - 2005+



STAINLESS STEEL  
**TSUN-P14**

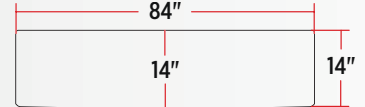

### TECHNICAL SPECIFICATIONS

#### HIGH ROOF MODELS

**PETERBILT MODELS** (2005+)

DIMENSIONS	Width: 84"   Sides: 14"   Drop: 14"
WHAT'S INCLUDED	6 x Sun Visor Brackets & Hardware
WARRANTY	1 Year

Will NOT work on the new 1 Piece Windshields. Designed to fit OEM Stainless Steel Visors. Visit our website at [www.truxaccessories.com](http://www.truxaccessories.com) for Installation Instructions.

## 14" BOLTLESS LOW ROOF SUN VISOR - 1987+



STAINLESS STEEL  
**TSUN-P25**

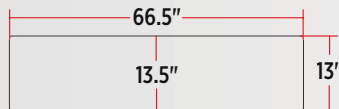

### TECHNICAL SPECIFICATIONS

#### LOW ROOF MODELS

**PETERBILT MODELS** (1987+)

DIMENSIONS	Width: 66.5"   Sides: 13"   Drop: 13.5"
WHAT'S INCLUDED	6 x Sun Visor Brackets & Hardware
WARRANTY	1 Year

Visit our website at [www.truxaccessories.com](http://www.truxaccessories.com) for Installation Instructions. Depending on Truck Year, Drilling may be required.

## 12" BOLTLESS BOWTIE LOW ROOF SUN VISOR - 1987+



STAINLESS STEEL  
**TSUN-P26**

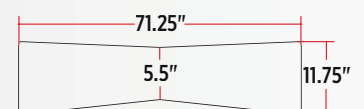

### TECHNICAL SPECIFICATIONS

#### LOW ROOF MODELS

**PETERBILT MODELS** (1987+)

DIMENSIONS	Width: 71.25"   Sides: 11.75"   Drop: 5.5"
WHAT'S INCLUDED	4 x Sun Visor Brackets & Hardware
WARRANTY	1 Year

Visit our website at [www.truxaccessories.com](http://www.truxaccessories.com) for Installation Instructions. Depending on Truck Year, Drilling may be required.

**WARNING:** Cancer and Reproductive Harm - [www.p65warnings.ca.gov](http://www.p65warnings.ca.gov)

## 13" LOW ROOF FLAT GLASS SUN VISOR - 2005+



STAINLESS STEEL  
**TSUN-P20**



### TECHNICAL SPECIFICATIONS

#### MODELS WITH CAB MOUNTED MIRRORS

**389, 388, 386, 384, 379, 378, 367, 365, 357, 348, 340, 337, 335 & 330** (2005+)

DIMENSIONS	Width: 72"   Sides: 16"   Drop: 13"
WHAT'S INCLUDED	3 x Sun Visor Brackets & Hardware
WARRANTY	1 Year

Visit our website at [www.truxaccessories.com](http://www.truxaccessories.com) for Installation Instructions. Depending on Truck Year, Drilling may be required.

## 15" V SHAPED LOW ROOF SUN VISOR - 2005+



STAINLESS STEEL  
**TSUN-P24**

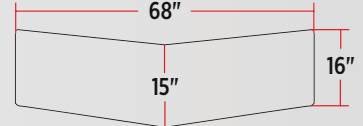

### TECHNICAL SPECIFICATIONS

#### LOW ROOF MODELS

**389, 388, 379, 378 & 367** (2005+)

DIMENSIONS	Width: 68"   Sides: 16"   Drop: 15"
WHAT'S INCLUDED	3 x Sun Visor Brackets & Hardware
WARRANTY	1 Year

Visit our website at [www.truxaccessories.com](http://www.truxaccessories.com) for Installation Instructions. Depending on Truck Year, Drilling may be required.

## 15" HIGH ROOF CURVED GLASS SUN VISOR - 2000+



STAINLESS STEEL  
**TSUN-P28**

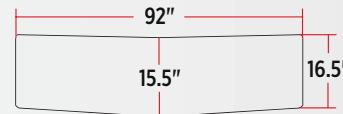

### TECHNICAL SPECIFICATIONS

#### MODELS WITH DOOR MOUNTED MIRRORS

**587 & 387** (2000+)

DIMENSIONS	Width: 92"   Sides: 16.5"   Drop: 15.5"
WHAT'S INCLUDED	3 x Sun Visor Brackets & Hardware
WARRANTY	1 Year

Visit our website at [www.truxaccessories.com](http://www.truxaccessories.com) for Installation Instructions.

## 11" BOLTLESS WAVE HIGH ROOF SUN VISOR - 2002+

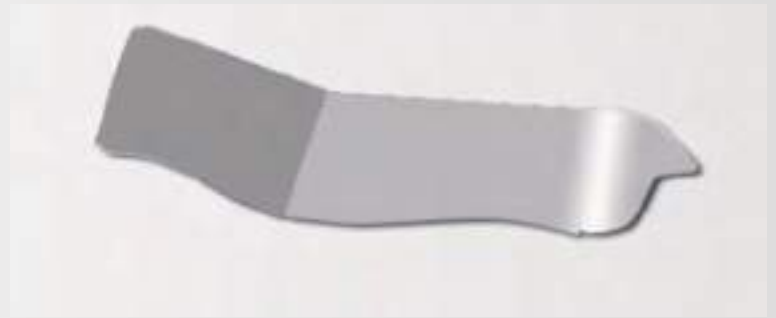

STAINLESS STEEL  
**TSUN-P30**

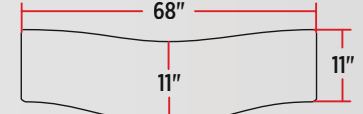

### TECHNICAL SPECIFICATIONS

#### HIGH ROOF MODELS

**389, 388, 386, 384, 379, 378, 367, 365 & 357** (2002+)

DIMENSIONS	Width: 68"   Sides: 10"   Drop: 11"
WHAT'S INCLUDED	6 x Sun Visor Brackets & Hardware
WARRANTY	1 Year

Replaces OEM Sun Visor. Visit our website at [www.truxaccessories.com](http://www.truxaccessories.com) for Installation Instructions.

# PETERBILT SUN VISORS

## 14" HIGH ROOF FLAT GLASS SUN VISOR - PRE-2005



STAINLESS STEEL  
**TSUN-P8**

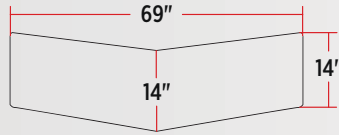

### TECHNICAL SPECIFICATIONS

#### MODELS WITH DOOR MOUNTED MIRRORS

**389, 388, 386, 384, 379, 378, 367, 365, 357, 348, 340, 337, 335 & 330** (Pre-2005)

DIMENSIONS	Width: 69"   Sides: 14"   Drop: 14"
WHAT'S INCLUDED	3 x Sun Visor Brackets & Hardware
WARRANTY	1 Year

Visit our website at [www.truxaccessories.com](http://www.truxaccessories.com) for Installation Instructions.

## 14" HIGH ROOF FLAT GLASS SUN VISOR - 2005+



STAINLESS STEEL  
**TSUN-P11**

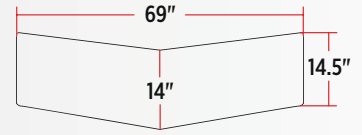

### TECHNICAL SPECIFICATIONS

#### MODELS WITH CAB MOUNTED MIRRORS

**389, 388, 386, 384, 379, 378, 367, 365, 357, 348, 340, 337, 335 & 330** (2005+)

DIMENSIONS	Width: 69"   Sides: 14.5"   Drop: 14"
WHAT'S INCLUDED	6 x Sun Visor Brackets & Hardware
WARRANTY	1 Year

Visit our website at [www.truxaccessories.com](http://www.truxaccessories.com) for Installation Instructions.

## 13" LOW ROOF FLAT GLASS SUN VISOR - PRE-2005



STAINLESS STEEL  
**TSUN-P17**



### TECHNICAL SPECIFICATIONS

#### MODELS WITH DOOR MOUNTED MIRRORS

**389, 388, 386, 384, 379, 378, 367, 365, 357, 348, 340, 337, 335 & 330** (Pre-2005)

DIMENSIONS	Width: 67"   Sides: 13"   Drop: 13"
WHAT'S INCLUDED	3 x Sun Visor Brackets & Hardware
WARRANTY	1 Year

Visit our website at [www.truxaccessories.com](http://www.truxaccessories.com) for Installation Instructions.

## 15" HIGH ROOF SLEEPER SUN VISOR - 2013+



STAINLESS STEEL  
**TSUN-P27** 5 x Slotted Holes  
**TSUN-P57** 20 x 3/4" Holes

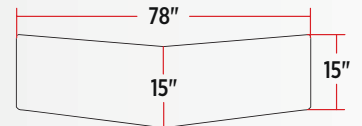

### TECHNICAL SPECIFICATIONS

#### HIGH ROOF SLEEPER MODEL

**579** (2013+)

DIMENSIONS	Width: 78"   Sides: 15"   Drop: 15"
WHAT'S INCLUDED	3 x Sun Visor Brackets & Hardware
WARRANTY	1 Year

Visit our website at [www.truxaccessories.com](http://www.truxaccessories.com) for Installation Instructions.

**WARNING:** Cancer and Reproductive Harm - [www.p65warnings.ca.gov](http://www.p65warnings.ca.gov)

## 378 BUG DEFLECTOR HOOD SHIELD - ALL YEARS



STAINLESS STEEL  
**THOD-PET3K**

### TECHNICAL SPECIFICATIONS

#### SHORT HOOD MODELS

**378** (All Years)

DIMENSIONS	Width: 48"
WHAT'S INCLUDED	Hardware
WARRANTY	1 Year

Visit our website at [www.truxaccessories.com](http://www.truxaccessories.com) for Installation Instructions.

## 379 BUG DEFLECTOR HOOD SHIELD - ALL YEARS



STAINLESS STEEL  
**THOD-PET379**

### TECHNICAL SPECIFICATIONS

#### PETERBILT MODEL

**379** (All Years)

DIMENSIONS	Width: 43"
WHAT'S INCLUDED	Hardware
WARRANTY	1 Year

Visit our website at [www.truxaccessories.com](http://www.truxaccessories.com) for Installation Instructions.

## 379 FRONT GRILLE OVAL PUNCH OUTS - ALL YEARS



STAINLESS STEEL  
**TP-1124** Long Hood Models  
**TP-1125** Short Hood Models

### TECHNICAL SPECIFICATIONS

#### PETERBILT 379 MODELS

**TP-1124** Long Hood (All Years) **TP-1125** Short Hood (All Years)

GAUGE	18 Gauge
DIMENSIONS	TP-1124: 42.25" x 33.75" TP-1125: 42.25" x 33.675"
WHAT'S INCLUDED	Hardware
WARRANTY	1 Year

Visit our website at [www.truxaccessories.com](http://www.truxaccessories.com) for Installation Instructions.

**WARNING: Cancer and Reproductive Harm - [www.p65warnings.ca.gov](http://www.p65warnings.ca.gov)**

## 386/384 BUG DEFLECTOR HOOD SHIELD - 2006+



STAINLESS STEEL  
**THOD-PET386**

### TECHNICAL SPECIFICATIONS

#### PETERBILT MODELS

**384 & 386** (2006+)

DIMENSIONS	Width: 47.5"
WHAT'S INCLUDED	Hardware
WARRANTY	1 Year

Drilling is required. Visit our website at [www.truxaccessories.com](http://www.truxaccessories.com) for Installation Instructions.

# PETERBILT BUG DEFLECTORS

## 389/388/367 BUG DEFLECTOR HOOD SHIELD - 2008+



STAINLESS STEEL  
**THOD-PET389**

### TECHNICAL SPECIFICATIONS

#### PETERBILT MODELS

**389, 388 & 367** Heavy Haul (2008+)

DIMENSIONS	Width: 52"
WHAT'S INCLUDED	Hardware
WARRANTY	1 Year

Visit our website at [www.truxaccessories.com](http://www.truxaccessories.com) for Installation Instructions.

## 389/388 FRONT GRILLE OVAL PUNCH OUT - ALL YEARS



STAINLESS STEEL  
**TP-1139**

### TECHNICAL SPECIFICATIONS

#### LONG HOOD MODELS

**389 & 388** (All Years)

GAUGE	18 Gauge
DIMENSIONS	Width: 36"   Height: 42"
WARRANTY	1 Year

Visit our website at [www.truxaccessories.com](http://www.truxaccessories.com) for Installation Instructions.

## 567 BUG DEFLECTOR HOOD SHIELD - 2013+



STAINLESS STEEL  
**THOD-PET567**

### TECHNICAL SPECIFICATIONS

#### PETERBILT MODEL

**567** (2013+)

DIMENSIONS	Width: 49.92"
WHAT'S INCLUDED	Hardware
WARRANTY	1 Year

Drilling is required. Visit our website at [www.truxaccessories.com](http://www.truxaccessories.com) for Installation Instructions.

## 335/337/340/348 BUG DEFLECTOR HOOD SHIELD - ALL YEARS



STAINLESS STEEL  
**THOD-PET335**

### TECHNICAL SPECIFICATIONS

#### PETERBILT MODELS

**335, 337, 340 & 348** (All Years)

DIMENSIONS	Width: 49.3"
WHAT'S INCLUDED	Hardware
WARRANTY	1 Year

Visit our website at [www.truxaccessories.com](http://www.truxaccessories.com) for Installation Instructions.

 **WARNING:** Cancer and Reproductive Harm - [www.p65warnings.ca.gov](http://www.p65warnings.ca.gov)

## 579 BUG DEFLECTOR HOOD SHIELD - 2013+



STAINLESS STEEL  
**THOD-PET579**

### TECHNICAL SPECIFICATIONS

#### PETERBILT MODEL

**579** (2013+)

DIMENSIONS	Width: 58"
WHAT'S INCLUDED	Hardware
WARRANTY	1 Year

Drilling is required. Visit our website at [www.truxaccessories.com](http://www.truxaccessories.com) for Installation Instructions.

## 579 GRILLE SURROUND 2013+



STAINLESS STEEL  
**TP-1131**

### TECHNICAL SPECIFICATIONS

#### PETERBILT MODEL

**579** (2013+)

WHAT'S INCLUDED	Hardware & 3M Tape (Double Side)
SOLD	As a Kit (4 Pieces)
WARRANTY	1 Year

Drilling is required. Visit our website at [www.truxaccessories.com](http://www.truxaccessories.com) for Installation Instructions.

## 587 BUG DEFLECTOR HOOD SHIELD - 2011+



STAINLESS STEEL  
**THOD-PET587**

### TECHNICAL SPECIFICATIONS

#### PETERBILT MODEL

**587** (2011+)

DIMENSIONS	Width: 51"
WHAT'S INCLUDED	Hardware
WARRANTY	1 Year

Visit our website at [www.truxaccessories.com](http://www.truxaccessories.com) for Installation Instructions.

## 587/387 BUG DEFLECTOR HOOD SHIELD - 2000+



STAINLESS STEEL  
**THOD-PET387**

### TECHNICAL SPECIFICATIONS

#### PETERBILT MODELS

**387 & 587** (2000+)

DIMENSIONS	Width: 54.4"
WHAT'S INCLUDED	Hardware
WARRANTY	1 Year

Visit our website at [www.truxaccessories.com](http://www.truxaccessories.com) for Installation Instructions.

# PETERBILT 379/378



- 430 Mirror Shine Stainless Steel
- LED Lighting
- 1 Year Warranty

- Hardware Included
- Pre-Wired & Assembled Kits\*

\*Depending on Part Number

## FRONT AIR CLEANER LIGHT BARS STAINLESS STEEL

	PANEL SIZE	2" HOLES			3/4" HOLES		
<b>FRONT STANDARD AIR CLEANERS</b> 379 & 378 1987-2004	19.5" LONG	<b>TP-1801</b> 12 x 2" HOLES	<b>TP-1801L</b> 12 x TLED-2A	<b>TP-1801LC</b> 12 x TLED-2TA	-	-	-
<b>FRONT STANDARD AIR CLEANERS</b> 379 & 378 ALL YEARS	20.25" LONG 4.81" MOUNT	<b>TP-1808</b> 12 x 2" HOLES	<b>TP-1808L</b> 12 x TLED-2A	<b>TP-1808LC</b> 12 x TLED-2TA	-	-	-
<b>FRONT STANDARD AIR CLEANERS</b> 379 & 378 1987-2004	26" LONG	<b>TP-1814</b> 16 x 2" HOLES	<b>TP-1814L</b> 16 x TLED-2A	<b>TP-1814LC</b> 16 x TLED-2TA	<b>TP-1863</b> 20 x 3/4" HOLES	<b>TP-1863L</b> 20 x TLED-B2A	<b>TP-1863LC</b> 20 x TLED-B2CA
<b>FRONT STANDARD AIR CLEANERS</b> 379 & 378 ALL YEARS	27" LONG 4.81" MOUNT	<b>TP-1820</b> 16 x 2" HOLES	<b>TP-1820L</b> 16 x TLED-2A	<b>TP-1820LC</b> 16 x TLED-2TA	-	-	-

Attaches to the bracket between the Hood & Air Cleaner with existing hardware.

	PANEL SIZE	G2 HOLES			3/4" HOLES		
<b>FRONT STANDARD AIR CLEANERS</b> 379 & 378 1987+	19.5" LONG 1.5" MOUNT	<b>TP-1852</b> 12 x G2 HOLES	<b>TP-1852LM</b> 12 x TLED-G2A	<b>TP-1852LMC</b> 12 x TLED-G2CA	-	-	-
<b>FRONT STANDARD AIR CLEANERS</b> 379 & 378 2005-2007	25.5" LONG 6.5" MOUNT	<b>TP-1855</b> 16 x G2 HOLES	<b>TP-1855LM</b> 16 x TLED-G2A	<b>TP-1855LMC</b> 16 x TLED-G2CA	-	-	-
<b>FRONT 15" STANDARD AIR CLEANERS</b> 379 & 378 1987+	26" LONG 5.07" MOUNT	<b>TP-1840</b> 16 x G2 HOLES	<b>TP-1840LM</b> 16 x TLED-G2A	<b>TP-1840LMC</b> 16 x TLED-G2CA	-	-	-

Attaches to the bracket between the Hood & Air Cleaner with existing hardware.

 WARNING: Cancer and Reproductive Harm - [www.p65warnings.ca.gov](http://www.p65warnings.ca.gov)







# REAR AIR CLEANER LIGHT BARS

## STAINLESS STEEL

	PANEL SIZE	2" HOLES			3/4" HOLES		
<b>REAR 13" STANDARD AIR CLEANERS</b> 379 & 378 1987-2004	19.5" LONG	<b>TP-1803</b> 12 x 2" HOLES	<b>TP-1803L</b> 12 x TLED-2R	<b>TP-1803LC</b> 12 x TLED-2TR	-	-	-
<b>REAR 15" STANDARD AIR CLEANERS</b> 379 & 378 1987+	20.25" LONG 7.25" MOUNT	<b>TP-1810</b> 12 x 2" HOLES	<b>TP-1810L</b> 12 x TLED-2R	<b>TP-1810LC</b> 12 x TLED-2TR	-	-	-
<b>REAR 13" STANDARD DONALDSON AIR CLEANERS</b> 379 & 378 2005+	20.5" LONG 2.63" MOUNT	<b>TP-1809</b> 12 x 2" HOLES	<b>TP-1809L</b> 12 x TLED-2R	<b>TP-1809LC</b> 12 x TLED-2TR	-	-	-
<b>REAR 15" STANDARD AIR CLEANERS</b> 379 & 378 ALL YEARS	21.5" LONG	<b>TP-1805</b> 12 x 2" HOLES	<b>TP-1805L</b> 12 x TLED-2R	<b>TP-1805LC</b> 12 x TLED-2TR	-	-	-
<b>REAR 13" STANDARD AIR CLEANERS</b> 379 & 378 1987-2004	26" LONG	<b>TP-1816</b> 16 x 2" HOLES	<b>TP-1816L</b> 16 x TLED-2R	<b>TP-1816LC</b> 16 x TLED-2TR	-	-	-
<b>REAR 15" STANDARD AIR CLEANERS</b> 379 & 378 ALL YEARS	26" LONG	<b>TP-1818</b> 16 x 2" HOLES	<b>TP-1818L</b> 16 x TLED-2R	<b>TP-1818LC</b> 16 x TLED-2TR	<b>TP-1864</b> 20 x 3/4" HOLES	<b>TP-1864L</b> 20 x TLED-B2R	<b>TP-1864LC</b> 20 x TLED-B2CR
<b>REAR 15" STANDARD AIR CLEANERS</b> 379 & 378 1987-2004	27" LONG 7.25" MOUNT	<b>TP-1822</b> 16 x 2" HOLES	<b>TP-1822L</b> 16 x TLED-2R	<b>TP-1822LC</b> 16 x TLED-2TR	-	-	-
<b>REAR 13"/15" STANDARD AIR CLEANERS</b> 379 & 378 2005+	27.25" LONG 8" MOUNT	<b>TP-1821</b> 16 x 2" HOLES	<b>TP-1821L</b> 16 x TLED-2R	<b>TP-1821LC</b> 16 x TLED-2TR	-	-	-

Attaches to the bracket between the Cab & Air Cleaner with existing hardware.

	PANEL SIZE	G2 HOLES			3/4" HOLES		
<b>REAR 13" STANDARD DONALDSON AIR CLEANERS</b> 379 & 378 1987+	18.36" LONG 1.5" MOUNT	<b>TP-1812</b> 12 x G2 HOLES	<b>TP-1812LM</b> 12 x TLED-G2R	<b>TP-1812LMC</b> 12 x TLED-G2CR	-	-	-
<b>REAR 15" STANDARD VORTEX AIR CLEANERS</b> 379 & 378 1987-2004	24.48" LONG 7.31" MOUNT	<b>TP-1857</b> 16 x G2 HOLES	<b>TP-1857LM</b> 16 x TLED-G2R	<b>TP-1857LMC</b> 16 x TLED-G2CR	-	-	-
<b>REAR 15" STANDARD AIR CLEANERS</b> 379 & 378 1987+	18.36" LONG 4.59" MOUNT	<b>TP-1868</b> 12 x G2 HOLES	<b>TP-1868LM</b> 12 x TLED-G2R	<b>TP-1868LMC</b> 12 x TLED-G2CR	-	-	-

Attaches to the bracket between the Cab & Air Cleaner with existing hardware.

# PETERBILT 379/378



- 430 Mirror Shine Stainless Steel
- LED Lighting
- 1 Year Warranty

- Hardware Included
- Pre-Wired & Assembled Kits\*

\*Depending on Part Number

## LOWER HOOD PANEL STAINLESS STEEL

	PANEL WIDTH	BLANK	G4 HOLES			3/4" HOLES		
<b>379</b> PRE-2007	-	<b>TP-1109</b>	-	-	-	-	-	-
						<b>2" HOLES</b>		
						-	-	-

## COWL PANELS STAINLESS STEEL

	PANEL WIDTH	BLANK	G4 HOLES			3/4" HOLES		
<b>379 &amp; 378</b> ALL YEARS	3.5" WIDE	<b>TP-1304</b>	<b>TP-1306</b> 8 x G4 HOLES	<b>TP-1306LM</b> 8 x TLED-G4A	<b>TP-1306LMC</b> 8 x TLED-G4CA	<b>TP-13126</b> 12 x 3/4" HOLES	<b>TP-13126L</b> 12 x TLED-B2A	<b>TP-13126LC</b> 12 x TLED-B2CA
						<b>2" HOLES</b>		
						<b>TP-1305</b> 8 x 2" HOLES	<b>TP-1305L</b> 8 x TLED-2A	<b>TP-1305LC</b> 8 x TLED-2TA

Depending on Model Year, Drilling may be required.

 WARNING: Cancer and Reproductive Harm - [www.p65warnings.ca.gov](http://www.p65warnings.ca.gov)

## CAB PANELS STAINLESS STEEL

	PANEL WIDTH	BLANK	G4 HOLES			3/4" HOLES		
<b>379 &amp; 378</b> ALL YEARS NO BLOCK HEATER	3.5" WIDE	<b>TP-1301</b>	<b>TP-1303</b> 6 x G4 HOLES	<b>TP-1303LM</b> 6 x TLED-G4A	<b>TP-1303LMC</b> 6 x TLED-G4CA	<b>TP-13110</b> 28 x 3/4" HOLES	<b>TP-13110L</b> 28 x TLED-B2A	<b>TP-13110LC</b> 28 x TLED-B2CA
						<b>2" HOLES</b>		
						<b>TP-1302</b> 10 x 2" HOLES	<b>TP-1302L</b> 10 x TLED-2A	<b>TP-1302LC</b> 10 x TLED-2TA

## 78" (OLD 70") SLEEPER WITH EXTENDERS STAINLESS STEEL

	PANEL WIDTH	BLANK	G4 HOLES			3/4" HOLES		
<b>78" SLEEPER</b> (OLD 70" SIZE) 379 & 378 1993+	3.5" WIDE	<b>TP-1504</b>	<b>TP-1506</b> 12 x G4 HOLES	<b>TP-1506LM</b> 12 x TLED-G4A	<b>TP-1506LMC</b> 12 x TLED-G4CA	-	-	-
						<b>2" HOLES</b>		
						<b>TP-1505</b> 16 x 2" HOLES	<b>TP-1505L</b> 16 x TLED-2A	<b>TP-1505LC</b> 16 x TLED-2TA

	PANEL WIDTH	BLANK	G4 HOLES			3/4" HOLES		
<b>78" SLEEPER</b> (OLD 70" SIZE) 379 & 378 ALL YEARS	4" WIDE	-	-	-	-	<b>TP-15132</b> 28 x 3/4" HOLES	<b>TP-15132L</b> 28 x TLED-B2A	<b>TP-15132LC</b> 28 x TLED-B2CA
						<b>2" HOLES</b>		
						-	-	-

Fits 78" Sleepers (Old 70" sleeper size) with extension. To be used with an Extension Panel or End Cap. Drilling may be required. Hardware is included.

## 72" (OLD 63") SLEEPER WITH EXTENDERS STAINLESS STEEL

	PANEL WIDTH	BLANK	G4 HOLES			3/4" HOLES		
<b>72" SLEEPER</b> (OLD 63" SIZE) 379 & 378 ALL YEARS	3.5" WIDE	<b>TP-1501</b>	<b>TP-1503</b> 10 x G4 HOLES	<b>TP-1503LM</b> 10 x TLED-G4A	<b>TP-1503LMC</b> 10 x TLED-G4CA	<b>TP-15128</b> 36 x 3/4" HOLES	<b>TP-15128L</b> 36 x TLED-B2A	<b>TP-15128LC</b> 36 x TLED-B2CA
						<b>2" HOLES</b>		
						<b>TP-1502</b> 16 x 2" HOLES	<b>TP-1502L</b> 16 x TLED-2A	<b>TP-1502LC</b> 16 x TLED-2TA

Fits 72" Sleepers (Old 63" sleeper size) with extension. To be used with an Extension Panel or End Cap. Drilling may be required. Hardware is included.

## 58" (OLD 48") SLEEPER WITH EXTENDERS STAINLESS STEEL

	PANEL WIDTH	BLANK	G4 HOLES			3/4" HOLES		
<b>58" SLEEPER</b> (OLD 48" SIZE) 379 & 378 ALL YEARS	3.5" WIDE	<b>TP-1510</b>	<b>TP-1512</b> 8 x G4 HOLES	<b>TP-1512LM</b> 8 x TLED-G4A	<b>TP-1512LMC</b> 8 x TLED-G4CA	-	-	-
						<b>2" HOLES</b>		
						<b>TP-1511</b> 10 x 2" HOLES	<b>TP-1511L</b> 10 x TLED-2A	<b>TP-1511LC</b> 10 x TLED-2TA

Fits 58" Sleepers (Old 48" sleeper size) with extension. To be used with an Extension Panel or End Cap. Drilling may be required. Hardware is included.

 **WARNING: Cancer and Reproductive Harm - [www.p65warnings.ca.gov](http://www.p65warnings.ca.gov)**

# PETERBILT 379/378

## EXTENDER PANELS STAINLESS STEEL

	PANEL WIDTH	BLANK	G4 HOLES			3/4" HOLES		
<b>78" SLEEPER</b> (OLD 70" SIZE) 379 & 378 ALL YEARS	3.5" WIDE	TP-1516	TP-1518 2 x G4 HOLES	TP-1518LM 2 x TLED-G4A	TP-1518LMC 2 x TLED-G4CA	-	-	-
						<b>2" HOLES</b>		
						TP-1517 4 x 2" HOLES	TP-1517L 4 x TLED-2A	TP-1517LC 4 x TLED-2TA

Fits 78" Sleepers (Old 70" sleeper size) with extension. Drilling may be required. Hardware is included. Is designed to continue the Sleeper Kit to the end of the Sleeper.

	PANEL WIDTH	BLANK	G4 HOLES			3/4" HOLES		
<b>78" SLEEPER</b> (OLD 70" SIZE) 379 & 378 ALL YEARS	4" WIDE	-	-	-	-	TP-15140 4 x 3/4" HOLES	TP-15140L 4 x TLED-B2A	TP-15140LC 4 x TLED-B2CA

Fits 78" Sleepers (Old 70" sleeper size) with extension. Drilling may be required. Hardware is included. Is designed to continue the Sleeper Kit to the end of the Sleeper.

	PANEL WIDTH	BLANK	G4 HOLES			3/4" HOLES		
<b>44"/58"/72" SLEEPER</b> (36"/48"/63" OLD SIZE) 379 & 378 ALL YEARS	3.5" WIDE	TP-1513	TP-1515 2 x G4 HOLES	TP-1515LM 2 x TLED-G4A	TP-1515LMC 2 x TLED-G4CA	TP-15129 14 x 3/4" HOLES	TP-15129L 14 x TLED-B2A	TP-15129LC 14 x TLED-B2CA
						<b>2" HOLES</b>		
						TP-1514 6 x 2" HOLES	TP-1514L 6 x TLED-2A	TP-1514LC 6 x TLED-2TA

Fits 72"/58"/44" Sleepers (OLD 63"/48"/36" sleeper size) with extension. Drilling may be required. Hardware is included. Is designed to continue the Sleeper Kit to the end of the Sleeper.



## SOUTHERN STYLE 6" / 9" WIDE PANELS





- 430 Mirror Shine Stainless Steel
- LED Lighting
- 1 Year Warranty
- Hardware Included
- Pre-Wired & Assembled Kits\*

\*Depending on Part Number

## 6" WIDE COWL, CAB & SLEEPER KITS STAINLESS STEEL

	PANEL WIDTH	BLANK	G4 HOLES			3/4" HOLES		
<b>6" WIDE 78" SLEEPERS</b> (OLD 70" SIZE) 379 & 378 1993-2007	6" WIDE	TP-1009	TP-1064 34 x G4 HOLES	TP-1064LM 34 x TLED-G4A	TP-1064LMC 34 x TLED-G4CA	-	-	-

Fits 78" Sleepers (Old 70" sleeper size). Drilling may be required. Hardware is included.

	PANEL WIDTH	BLANK	G4 HOLES			3/4" HOLES		
<b>6" WIDE 72" SLEEPERS</b> (OLD 63" SIZE) 379 & 378 1993-2007	6" WIDE	TP-1007	TP-1062 30 x G4 HOLES	TP-1062LM 30 x TLED-G4A	TP-1062LMC 30 x TLED-G4CA	-	-	-

Fits 72" Sleepers (Old 63" sleeper size). Drilling may be required. Hardware is included.

 WARNING: Cancer and Reproductive Harm - www.p65warnings.ca.gov

## 9" WIDE COWL, CAB & SLEEPER KITS STAINLESS STEEL



	PANEL WIDTH	BLANK	G4 HOLES			3/4" HOLES		
<b>9" WIDE 78" SLEEPERS</b> (OLD 70" SIZE) 379 & 378 1993-2007	9" WIDE	<b>TP-1005</b>	-	-	-	-	-	-

Fits 78" Sleepers (Old 70" sleeper size) with extension. Drilling may be required. Hardware is included.

<b>9" WIDE 72" SLEEPERS</b> (OLD 63" SIZE) 379 & 378 1993-2007	9" WIDE	<b>TP-1003</b>	<b>TP-1065</b> 24 x G4 HOLES	<b>TP-1065LM</b> 24 x TLED-G4A	<b>TP-1065LMC</b> 24 x TLED-G4CA	<b>TP-10221</b> 42 x 3/4" HOLES	<b>TP-10221L</b> 42 x TLED-B2A	<b>TP-10221LC</b> 42 x TLED-B2CA
---	---------	----------------	---------------------------------	-----------------------------------	-------------------------------------	------------------------------------	-----------------------------------	-------------------------------------

Fits 72" Sleepers (Old 63" sleeper size) with extension. Drilling may be required. Hardware is included.

## 6" WIDE COWL, CAB, SLEEPER & EXTENDER KITS STAINLESS STEEL

	PANEL WIDTH	BLANK	G4 HOLES			3/4" HOLES		
<b>6" WIDE 78" SLEEPERS</b> (OLD 70" SIZE) 379 & 378 1993-2007	6" WIDE	<b>TP-1091</b>	-	-	-	<b>TP-10220</b> 48 x 3/4" HOLES	<b>TP-10220L</b> 48 x TLED-B2A	<b>TP-10220LC</b> 48 x TLED-B2CA

Fits 78" Sleepers (Old 70" sleeper size) with extension. Drilling may be required. Hardware is included.

<b>6" WIDE 72" SLEEPERS</b> (OLD 63" SIZE) 379 & 378 1993-2007	6" WIDE	<b>TP-1090</b>	<b>TP-1063</b> 34 x G4 HOLES	<b>TP-1063LM</b> 34 x TLED-G4A	<b>TP-1063LMC</b> 34 x TLED-G4CA	-	-	-
---	---------	----------------	---------------------------------	-----------------------------------	-------------------------------------	---	---	---

Fits 72" Sleepers (Old 63" sleeper size) with extension. Drilling may be required. Hardware is included.

## 9" WIDE COWL, CAB, SLEEPER & EXTENDER KITS STAINLESS STEEL

	PANEL WIDTH	BLANK	G4 HOLES			3/4" HOLES		
<b>9" WIDE 78" SLEEPERS</b> (OLD 70" SIZE) 379 & 378 1993-2007	9" WIDE	<b>TP-1093</b>	<b>TP-1067</b> 28 x G4 HOLES	<b>TP-1067LM</b> 28 x TLED-G4A	<b>TP-1067LMC</b> 28 x TLED-G4CA	<b>TP-10195</b> 46 x 3/4" HOLES	<b>TP-10195L</b> 46 x TLED-B2A	<b>TP-10195LC</b> 46 x TLED-B2CA

Fits 78" Sleepers (Old 70" sleeper size) with extension. Drilling may be required. Hardware is included.

<b>9" WIDE 72" SLEEPERS</b> (OLD 63" SIZE) 379 & 378 1993-2007	9" WIDE	<b>TP-1092</b>	<b>TP-1066</b> 28 x G4 HOLES	<b>TP-1066LM</b> 28 x TLED-G4A	<b>TP-1066LMC</b> 28 x TLED-G4CA	-	-	-
---	---------	----------------	---------------------------------	-----------------------------------	-------------------------------------	---	---	---

Fits 72" Sleepers (Old 63" sleeper size) with extension. Drilling may be required. Hardware is included.

# PETERBILT 389



- 430 Mirror Shine Stainless Steel
- LED Lighting
- 1 Year Warranty

- Hardware Included
- Pre-Wired & Assembled Kits\*

\*Depending on Part Number

## FRONT AIR CLEANER LIGHT BARS STAINLESS STEEL

	PANEL SIZE	2" HOLES			3/4" HOLES		
<b>FRONT STANDARD AIR CLEANERS</b> 389 ALL YEARS	20.25" LONG 4.81" MOUNT	<b>TP-1808</b> 12 x 2" HOLES	<b>TP-1808L</b> 12 x TLED-2A	<b>TP-1808LC</b> 12 x TLED-2TA	-	-	-
<b>FRONT 15" PREMIUM AIR CLEANERS</b> 389 & 388 2005+	22.25" LONG 6.4" MOUNT	<b>TP-1847</b> 12 x 2" HOLES	<b>TP-1847L</b> 12 x TLED-2A	<b>TP-1847LC</b> 12 x TLED-2TA	-	-	-
<b>FRONT STANDARD AIR CLEANERS</b> 389 ALL YEARS	26" LONG	-	-	-	<b>TP-1863</b> 20 x 3/4" HOLES	<b>TP-1863L</b> 20 x TLED-B2A	<b>TP-1863LC</b> 20 x TLED-B2CA
<b>FRONT STANDARD AIR CLEANERS</b> 389 & 388 ALL YEARS	27" LONG 4.81" MOUNT	<b>TP-1820</b> 16 x 2" HOLES	<b>TP-1820L</b> 16 x TLED-2A	<b>TP-1820LC</b> 16 x TLED-2TA	-	-	-
<b>FRONT 15" PREMIUM AIR CLEANERS</b> 389 & 388 2010+	27.88" LONG 5.63" MOUNT	<b>TP-1846</b> 16 x 2" HOLES	<b>TP-1846L</b> 16 x TLED-2A	<b>TP-1846LC</b> 16 x TLED-2TA	-	-	-

Attaches to the bracket between the Hood & Air Cleaner with existing hardware.

	PANEL SIZE	G2 HOLES			3/4" HOLES		
<b>FRONT STANDARD AIR CLEANERS</b> 389 & 388 ALL YEARS	19.5" LONG 1.5" MOUNT	<b>TP-1852</b> 12 x G2 HOLES	<b>TP-1852LM</b> 12 x TLED-G2A	<b>TP-1852LMC</b> 12 x TLED-G2CA	-	-	-
<b>FRONT 15" PREMIUM AIR CLEANERS</b> 389 & 388 2010+	22.38" LONG 5.5" MOUNT	<b>TP-1853</b> 14 x G2 HOLES	<b>TP-1853LM</b> 14 x TLED-G2A	<b>TP-1853LMC</b> 14 x TLED-G2CA	<b>TP-1865</b> 12 x 3/4" HOLES	<b>TP-1865L</b> 12 x TLED-B2A	<b>TP-1865LC</b> 12 x TLED-B2CA





Attaches to the bracket between the Hood & Air Cleaner with existing hardware.

WARNING: Cancer and Reproductive Harm - [www.p65warnings.ca.gov](http://www.p65warnings.ca.gov)

## FRONT AIR CLEANER LIGHT BARS STAINLESS STEEL

	PANEL SIZE	G2 HOLES			3/4" HOLES		
<b>FRONT STANDARD AIR CLEANERS</b> 389 & 388 2005-2007	25.5" LONG 6.5" MOUNT	<b>TP-1855</b> 16 x G2 HOLES	<b>TP-1855LM</b> 16 x TLED-G2A	<b>TP-1855LMC</b> 16 x TLED-G2CA	-	-	-
<b>FRONT 15" STANDARD AIR CLEANERS</b> 389 & 388 ALL YEARS	26" LONG 5.07" MOUNT	<b>TP-1840</b> 16 x G2 HOLES	<b>TP-1840LM</b> 16 x TLED-G2A	<b>TP-1840LMC</b> 16 x TLED-G2CA	-	-	-

## REAR AIR CLEANER LIGHT BARS STAINLESS STEEL

	PANEL SIZE	2" HOLES			3/4" HOLES		
<b>REAR 15" STANDARD AIR CLEANERS</b> 389 & 388 ALL YEARS	20.25" LONG 7.25" MOUNT	<b>TP-1810</b> 12 x 2" HOLES	<b>TP-1810L</b> 12 x TLED-2R	<b>TP-1810LC</b> 12 x TLED-2TR	-	-	-
<b>REAR 13" STANDARD AIR CLEANERS</b> 389 & 388 2005+	20.5" LONG 2.63" MOUNT	<b>TP-1809</b> 12 x 2" HOLES	<b>TP-1809L</b> 12 x TLED-2R	<b>TP-1809LC</b> 12 x TLED-2TR	-	-	-
<b>REAR 15" PREMIUM AIR CLEANERS</b> 389 & 388 2010+	22" LONG 5.5" MOUNT	-	-	-	<b>TP-1866</b> 12 x 3/4" HOLES	<b>TP-1866L</b> 12 x TLED-B2R	<b>TP-1866LC</b> 12 x TLED-B2CR
<b>REAR 15" STANDARD AIR CLEANERS</b> 389 ALL YEARS	26" LONG	-	-	-	<b>TP-1864</b> 20 x 3/4" HOLES	<b>TP-1864L</b> 20 x TLED-B2R	<b>TP-1864LC</b> 20 x TLED-B2CR
<b>REAR 15" STANDARD AIR CLEANERS</b> 389 & 388 1987-2004	27" LONG 7.25" MOUNT	<b>TP-1822</b> 16 x 2" HOLES	<b>TP-1822L</b> 16 x TLED-2R	<b>TP-1822LC</b> 16 x TLED-2TR	-	-	-
<b>REAR 15" PREMIUM FLANGELESS AIR CLEANERS</b> 389 & 388 2010+	27.25" LONG 7.25" MOUNT	<b>TP-1867</b> 16 x 2" HOLES	<b>TP-1867L</b> 16 x TLED-2R	<b>TP-1867LC</b> 16 x TLED-2TR	-	-	-
<b>REAR 13"/15" STANDARD AIR CLEANERS</b> 389 & 388 2005+	27.25" LONG 8" MOUNT	<b>TP-1821</b> 16 x 2" HOLES	<b>TP-1821L</b> 16 x TLED-2R	<b>TP-1821LC</b> 16 x TLED-2TR	-	-	-

Attaches to the bracket between the Cab & Air Cleaner with existing hardware.

	PANEL SIZE	G2 HOLES			3/4" HOLES		
<b>REAR 15" STANDARD AIR CLEANERS</b> 389 & 388 ALL YEARS	18.36" LONG 1.5" MOUNT	<b>TP-1868</b> 12 x G2 HOLES	<b>TP-1868LM</b> 12 x TLED-G2R	<b>TP-1868LMC</b> 12 x TLED-G2CR	-	-	-
<b>REAR 15" PREMIUM AIR CLEANERS</b> 389 & 388 2010+	22.38" LONG 5.5" MOUNT	<b>TP-1854</b> 14 x G2 HOLES	<b>TP-1854LM</b> 14 x TLED-G2R	<b>TP-1854LMC</b> 14 x TLED-G2CR	-	-	-
<b>REAR 15" STANDARD VORTEX AIR CLEANERS</b> 389 & 388 1987-2004	24.48" LONG 7.31" MOUNT	<b>TP-1857</b> 16 x G2 HOLES	<b>TP-1857LM</b> 16 x TLED-G2R	<b>TP-1857LMC</b> 16 x TLED-G2CR	-	-	-

Attaches to the bracket between the Cab & Air Cleaner with existing hardware.

 **WARNING:** Cancer and Reproductive Harm - [www.p65warnings.ca.gov](http://www.p65warnings.ca.gov)

# PETERBILT 389



- 430 Mirror Shine Stainless Steel
- LED Lighting
- 1 Year Warranty

- Hardware Included
- Pre-Wired & Assembled Kits\*

\*Depending on Part Number

## DELUXE COWL PANELS STAINLESS STEEL

	PANEL WIDTH	BLANK	G4 HOLES			3/4" HOLES		
<b>LONG HOOD WITH STEP DPF</b> (131" BBC) 389 2014-2017 FOR 3" WIDE PANELS	-	<b>TP-13100</b>	<b>TP-1396</b> 10 x G4 HOLES	<b>TP-1396LM</b> 10 x TLED-G4A	<b>TP-1396LMC</b> 10 x TLED-G4CA	-	-	-

Passenger Side Cutout accommodates for DPF. Designed to fit with 3" Cab Panels. Install using supplied Hardware.

	PANEL WIDTH	BLANK	G4 HOLES			3/4" HOLES		
<b>LONG HOOD WITH STEP DPF</b> (131" BBC) 389 2014-2017 FOR 4" WIDE PANELS	-	-	-	-	-	<b>TP-13120</b> 10 x 3/4" HOLES	<b>TP-13120L</b> 10 x TLED-B2A	<b>TP-13120LC</b> 10 x TLED-B2CA

Passenger Side Cutout accommodates for DPF. Designed to fit with 4" Cab Panels. Install using supplied Hardware.

 WARNING: Cancer and Reproductive Harm - [www.p65warnings.ca.gov](http://www.p65warnings.ca.gov)



## DELUXE COWL PANELS STAINLESS STEEL

	PANEL WIDTH	BLANK	G4 HOLES			3/4" HOLES		
<b>LONG HOOD</b> (131" BBC) 389 2018+ FOR 4" PANELS	-	<b>TP-13150</b>	<b>TP-13159</b> 8 x G4 HOLES	<b>TP-13159LM</b> 8 x TLED-G4A	<b>TP-13159LMC</b> 8 x TLED-G4CA	<b>TP-13170</b> 10 x 3/4" HOLES	<b>TP-13170L</b> 10 x TLED-B2A	<b>TP-13170LC</b> 10 x TLED-B2CA

Use with 4" Wide Deluxe Cab & Sleeper Panels for 2018+ Models. Install using supplied Hardware.



## DELUXE CAB PANELS STAINLESS STEEL





	PANEL WIDTH	BLANK	G4 HOLES			3/4" HOLES		
<b>LONG HOOD</b> (131" BBC) 389 2014-2017 NO BLOCK HEATER	3" WIDE DRIVER SIDE	<b>TP-13101</b>	<b>TP-1398</b> 4 x G4 HOLES DRIVER SIDE	<b>TP-1398LM</b> 4 x TLED-G4A DRIVER SIDE	<b>TP-1398LMC</b> 4 x TLED-G4CA DRIVER SIDE	<b>TP-13121</b> 12 x 3/4" HOLES	<b>TP-13121L</b> 12 x TLED-B2A	<b>TP-13121LC</b> 12 x TLED-B2CA

Driver Side measures 3" Wide. Passenger Side measures 1.75" Wide. Drilling may be required.

	PANEL WIDTH	BLANK	G4 HOLES			3/4" HOLES		
<b>LONG HOOD</b> (131" BBC) 389 2018+ NO BLOCK HEATER	4" WIDE DRIVER SIDE	<b>TP-13149</b>	<b>TP-13168</b> 3 x G4 HOLES DRIVER SIDE	<b>TP-13168LM</b> 3 x TLED-G4A DRIVER SIDE	<b>TP-13168LMC</b> 3 x TLED-G4CA DRIVER SIDE	<b>TP-13169</b> 6 x 3/4" HOLES DRIVER SIDE	<b>TP-13169L</b> 6 x TLED-B2A DRIVER SIDE	<b>TP-13169LC</b> 6 x TLED-B2CA DRIVER SIDE

Driver Side measures 4" Wide, 37.85" Long. Passenger Side measures 0.82" tapering to 1.58" Wide & 43.57" Long. NOT to be used with OEM Cowl/Hood Extension Panels.

## OEM COWL PANELS STAINLESS STEEL

	PANEL WIDTH	BLANK	G4 HOLES			3/4" HOLES		
<b>LONG HOOD</b> (131" BBC) 389 2007-2017	-	<b>TP-1310</b>	-	-	-	-	-	-

Installs over the OEM Cowl using supplied hardware.

# PETERBILT 389

## OEM CAB PANELS STAINLESS STEEL

	PANEL WIDTH	BLANK	G4 HOLES			3/4" HOLES		
<b>LONG HOOD</b> (131" BBC) 389 2014-2017 NO BLOCK HEATER	3" WIDE	<b>TP-13102</b>	<b>TP-1397</b> 6 x G4 HOLES	<b>TP-1397LM</b> 6 x TLED-G4A	<b>TP-1397LMC</b> 6 x TLED-G4CA	<b>TP-13116</b> 14 x 3/4" HOLES	<b>TP-13116L</b> 14 x TLED-B2A	<b>TP-13116LC</b> 14 x TLED-B2CA

For use with OEM Cowl Panels. Some drilling is required.

	PANEL WIDTH	BLANK	G4 HOLES			3/4" HOLES		
<b>LONG HOOD</b> (131" BBC) 389 2018+ NO BLOCK HEATER	4" WIDE DRIVER SIDE	<b>TP-13171</b>	<b>TP-13166</b> 3 x G4 HOLES DRIVER SIDE	<b>TP-13166LM</b> 3 x TLED-G4A DRIVER SIDE	<b>TP-13166LMC</b> 3 x TLED-G4CA DRIVER SIDE	<b>TP-13167</b> 14 x 3/4" HOLES	<b>TP-13167L</b> 14 x TLED-B2A	<b>TP-13167LC</b> 14 x TLED-B2CA

Driver Side measures 4" Wide & 42.85" Long. Passenger Side measures 1.25" Wide & 42.88" Long. To be installed with OEM Cowl Panels using supplied hardware.

## SLEEPER WITHOUT EXTENDERS STAINLESS STEEL

	PANEL WIDTH	BLANK	G4 HOLES			3/4" HOLES		
<b>72" SLEEPERS</b> (OLD 63" SIZE) <b>LONG HOOD</b> (131" BBC) 389 2014-2017	3" WIDE	<b>TP-15158</b>	-	-	-	-	-	-
<b>72" SLEEPERS</b> (OLD 63" SIZE) <b>LONG HOOD</b> (131" BBC) 389 2007-2017 <b>SHORT HOOD</b> (123" BBC) 389 & 388 2007+	4" WIDE	-	<b>TP-1588</b> 8 x G4 HOLES	<b>TP-1588LM</b> 8 x TLED-G4A	<b>TP-1588LMC</b> 8 x TLED-G4CA	<b>TP-15156</b> 18 x 3/4" HOLES	<b>TP-15156L</b> 18 x TLED-B2A	<b>TP-15156LC</b> 18 x TLED-B2CA
<b>72" SLEEPERS</b> (OLD 63" SIZE) WITH WRAP <b>LONG HOOD</b> (131" BBC) 389 2018+	4" WIDE	<b>TP-15211</b>	<b>TP-15208</b> 8 x G4 HOLES	<b>TP-15208LM</b> 8 x TLED-G4A	<b>TP-15208LMC</b> 8 x TLED-G4CA	<b>TP-15212</b> 18 x 3/4" HOLES	<b>TP-15212L</b> 18 x TLED-B2A	<b>TP-15212LC</b> 18 x TLED-B2CA

Fits 72" Sleepers (Old 63" sleeper size) without Extension. Drilling may be required. Hardware is included.





<b>58" SLEEPERS</b> (OLD 48" SIZE) <b>LONG HOOD</b> (131" BBC) 389 2007-2017 <b>SHORT HOOD</b> (123" BBC) 389 & 388 2007+	4" WIDE	<b>TP-1583</b>	<b>TP-1585</b> 6 x G4 HOLES	<b>TP-1585LM</b> 6 x TLED-G4A	<b>TP-1585LMC</b> 6 x TLED-G4CA	<b>TP-15152</b> 14 x 3/4" HOLES	<b>TP-15152L</b> 14 x TLED-B2A	<b>TP-15152LC</b> 14 x TLED-B2CA
<b>58" SLEEPERS</b> (OLD 48" SIZE) WITH WRAP <b>LONG HOOD</b> (131" BBC) 389 2018+	4" WIDE	<b>TP-15214</b>	<b>TP-15207</b> 6 x G4 HOLES	<b>TP-15207LM</b> 6 x TLED-G4A	<b>TP-15207LMC</b> 6 x TLED-G4CA	<b>TP-15215</b> 14 x 3/4" HOLES	<b>TP-15215L</b> 14 x TLED-B2A	<b>TP-15215LC</b> 14 x TLED-B2CA

Fits 58" Sleepers (Old 48" sleeper size) without Extension. Drilling may be required. Hardware is included.

 WARNING: Cancer and Reproductive Harm - [www.p65warnings.ca.gov](http://www.p65warnings.ca.gov)

## 78" (OLD 70") SLEEPER WITH EXTENDERS

STAINLESS STEEL

	PANEL WIDTH	BLANK	G4 HOLES			3/4" HOLES		
<b>78" SLEEPERS</b> (OLD 70" SIZE) 389 & 388 2014-2017	3" WIDE	<b>TP-15159</b>	-	-	-	-	-	-
<b>78" SLEEPERS</b> (OLD 70" SIZE) <b>LONG HOOD</b> (131" BBC) 389 & 388 2007-2017 <b>SHORT HOOD</b> (123" BBC) 389 & 388 2007+	4" WIDE	-	-	-	-	<b>TP-15139</b> 22 x 3/4" HOLES	<b>TP-15139L</b> 22 x TLED-B2A	<b>TP-15139LC</b> 2 x TLED-B2CA
<b>78" SLEEPERS</b> (OLD 70" SIZE) <b>LONG HOOD</b> (131" BBC) 389 2007-2017 <b>SHORT HOOD</b> (123" BBC) 389 & 388 2007+	4" WIDE	-	<b>TP-1571</b> 10 x G4 HOLES	<b>TP-1571LM</b> 10 x TLED-G4A	<b>TP-1571LMC</b> 10 x TLED-G4CA	-	-	-
<b>78" SLEEPERS</b> (OLD 70" SIZE) <b>LONG HOOD</b> (131" BBC) 389 2018+	4" WIDE	<b>TP-15209</b>	<b>TP-15205</b> 10 x G4 HOLES	<b>TP-15205LM</b> 10 x TLED-G4A	<b>TP-15205LMC</b> 10 x TLED-G4CA	<b>TP-15210</b> 22 x 3/4" HOLES	<b>TP-15210L</b> 22 x TLED-B2A	<b>TP-15210LC</b> 22 x TLED-B2CA

Fits 78" Sleepers (Old 70" sleeper size) with extension. To be used with an Extension Panel or End Cap. Drilling may be required. Hardware is included.

## 72" (OLD 63") SLEEPER WITH EXTENDERS

STAINLESS STEEL

	PANEL WIDTH	BLANK	G4 HOLES			3/4" HOLES		
<b>72" SLEEPERS</b> (OLD 63" SIZE) 389 & 388 2014-2017	3" WIDE	<b>TP-15160</b>	<b>TP-15120</b> 14 x G4 HOLES	<b>TP-15120LM</b> 10 x TLED-G4A	<b>TP-15120LMC</b> 10 x TLED-G4CA	-	-	-
<b>72" SLEEPERS</b> (OLD 63" SIZE) <b>LONG HOOD</b> (131" BBC) 389 2007-2017 <b>SHORT HOOD</b> (123" BBC) 389 & 388 2007-2017	4" WIDE	-	-	-	-	<b>TP-15201</b> 18 x 3/4" HOLES	<b>TP-15201L</b> 18 x TLED-B2A	<b>TP-15201LC</b> 18 x TLED-B2CA
<b>72" SLEEPERS</b> (OLD 63" SIZE) <b>LONG HOOD</b> (131" BBC) 389 2018+	4" WIDE	<b>TP-15213</b>	<b>TP-15204</b> 8 x G4 HOLES	<b>TP-15204LM</b> 8 x TLED-G4A	<b>TP-15204LMC</b> 8 x TLED-G4CA	-	-	-

Fits 72" Sleepers (Old 63" sleeper size) with extension. To be used with an Extension Panel or End Cap. Drilling may be required. Hardware is included.



# PETERBILT 389

## 58" (OLD 48") SLEEPER WITH EXTENDER STAINLESS STEEL

	PANEL WIDTH	BLANK	G4 HOLES			3/4" HOLES		
<b>58" SLEEPERS</b> (OLD 48" SIZE) <b>LONG HOOD</b> (131" BBC) 389 2007-2017 <b>SHORT HOOD</b> (123" BBC) 389 & 388 2007+	4" WIDE	<b>TP-1595</b>	-	-	-	<b>TP-15200</b> 14 x 3/4" HOLES	<b>TP-15200L</b> 14 x TLED-B2A	<b>TP-15200LC</b> 14 x TLED-B2CA
<b>58" SLEEPERS</b> (OLD 48" SIZE) <b>LONG HOOD</b> (131" BBC) 389 2014-2017	3" WIDE	-	<b>TP-15185</b> 10 x G4 HOLES	<b>TP-15185LM</b> 10 x TLED-G4A	<b>TP-15185LMC</b> 10 x TLED-G4CA	-	-	-
<b>58" SLEEPERS</b> (OLD 48" SIZE) <b>LONG HOOD</b> (131" BBC) 389 2018+	4" WIDE	<b>TP-15216</b>	<b>TP-15203</b> 6 x G4 HOLES	<b>TP-15203LM</b> 6 x TLED-G4A	<b>TP-15203LMC</b> 6 x TLED-G4CA	-	-	-

Fits 58" Sleepers (Old 48" sleeper size) with extension. To be installed with Extension Panels.

## 78" (OLD 70") SLEEPERS EXTENDER PANELS FOR STAINLESS STEEL

	PANEL WIDTH	BLANK	G4 HOLES			3/4" HOLES		
<b>78" SLEEPERS</b> (OLD 70" SIZE) 389 2014-2017	3" WIDE	<b>TP-15163</b>	<b>TP-15118</b> 2 x G4 HOLES	<b>TP-15118LM</b> 2 x TLED-G4A	<b>TP-15118LMC</b> 2 x TLED-G4CA	-	-	-
<b>78" SLEEPERS</b> (OLD 70" SIZE) 389 & 388 2014-2017	4" WIDE	-	-	-	-	<b>TP-15140</b> 4 x 3/4" HOLES	<b>TP-15140L</b> 4 x TLED-B2A	<b>TP-15140LC</b> 4 x TLED-B2CA

Fits 78" Sleepers (Old 70" sleeper size) with extension. Drilling may be required. Hardware is included. Will NOT fit 2018+ Peterbilt 389 Long Hood Models.

## EXTENSION PANELS FOR 72"/58"/44" SLEEPERS STAINLESS STEEL

	PANEL WIDTH	BLANK	G4 HOLES			3/4" HOLES		
<b>72"/58"/44" SLEEPERS</b> (63"/48"/36" OLD SIZE) 389 - 2014+ 388 - 2007+	3" WIDE	<b>TP-15162</b>	-	-	-	-	-	-
<b>72"/58" SLEEPERS</b> (OLD 63"/48" SIZE) 389 2014+	3" WIDE	<b>TP-15137</b>	<b>TP-15119</b> 6 x G4 HOLES	<b>TP-15119LM</b> 6 x TLED-G4A	<b>TP-15119LMC</b> 6 x TLED-G4CA	-	-	-

Fits 72"/58"/44" Sleepers (OLD 63"/48"/36" sleeper size) with extension. Drilling may be required. Hardware is included.

 WARNING: Cancer and Reproductive Harm - [www.p65warnings.ca.gov](http://www.p65warnings.ca.gov)



- 430 Mirror Shine Stainless Steel
- LED Lighting
- 1 Year Warranty

- Hardware Included
- Pre-Wired & Assembled Kits\*

\*Depending on Part Number

## CAB, SLEEPER & EXTENSION KIT STAINLESS STEEL

	PANEL WIDTH	BLANK	SLIM HOLES			3/4" HOLES		
<b>78" SLEEPERS</b> (OLD 70" SIZE) WITH FAIRINGS 386 ALL YEARS	1 5/8" WIDE	-	<b>TP-10107</b> 24 x SLIM HOLES	<b>TP-10107LF</b> 24 x TLED-FG4A	<b>TP-10107LFC</b> 24 x TLED-FG4CA	<b>TP-10215</b> 62 x 3/4" HOLES	<b>TP-10215L</b> 62 x TLED-B2A	<b>TP-10215 LC</b> 62 x TLED-B2CA



 WARNING: Cancer and Reproductive Harm - [www.p65warnings.ca.gov](http://www.p65warnings.ca.gov)

# PETERBILT 587



- 430 Mirror Shine Stainless Steel
- LED Lighting
- 1 Year Warranty

- Hardware Included
- Pre-Wired & Assembled Kits\*

\*Depending on Part Number

## CAB, SLEEPER & EXTENSION KIT STAINLESS STEEL

	PANEL WIDTH	BLANK	G4 HOLES			3/4" HOLES		
<b>75" SLEEPERS</b> (OLD 70" SIZE) <b>HIGH ROOF</b> 389 2011+ BLOCK HEATER HOLE	5" WIDE	-	<b>TP-10127</b> 14 x G4 HOLES	<b>TP-10127LM</b> 14 x TLED-G4A	<b>TP-10127LMC</b> 14 x TLED-G4CA	-	-	-



 WARNING: Cancer and Reproductive Harm - [www.p65warnings.ca.gov](http://www.p65warnings.ca.gov)



- 430 Mirror Shine Stainless Steel
- LED Lighting
- 1 Year Warranty

- Hardware Included
- Pre-Wired & Assembled Kits\*

\*Depending on Part Number

## CAB & 80" SLEEPER KITS WITHOUT EXTENSION LONG HOOD MODELS - STAINLESS STEEL

	PANEL WIDTH	BLANK	G4 HOLES			3/4" HOLES		
<b>80" SLEEPERS UNDERBODY EXHAUST</b> (123" BBC) 579 2013+ 1 BLOCK HEATER	2.5" WIDE	-	<b>TP-10138</b> 16 x G4 HOLES	<b>TP-10138LM</b> 16 x TLED-G4A	<b>TP-10138LMC</b> 16 x TLED-G4CA	-	-	-
<b>80" SLEEPERS UNDERBODY EXHAUST</b> (123" BBC) 579 2013+ 2 BLOCK HEATER	2.5" WIDE	<b>TP-10168</b>	-	-	-	-	-	-



 WARNING: Cancer and Reproductive Harm - [www.p65warnings.ca.gov](http://www.p65warnings.ca.gov)

# PETERBILT 579

## CAB & 72" SLEEPER KITS WITHOUT EXTENSION LONG HOOD MODELS - STAINLESS STEEL

	PANEL WIDTH	BLANK	G4 HOLES			3/4" HOLES		
<b>72" SLEEPERS UNDERBODY EXHAUST</b> (123" BBC) 579 2013+ 1 BLOCK HEATER	2.5" WIDE	-	<b>TP-10120</b> 14 x G4 HOLES	<b>TP-10120LM</b> 14 x TLED-G4A	<b>TP-10120LMC</b> 14 x TLED-G4CA	-	-	-
<b>72" SLEEPERS UNDERBODY EXHAUST</b> (123" BBC) 579 2013+ 2 BLOCK HEATER	2.5" WIDE	<b>TP-10166</b>	-	-	-	-	-	-

## CAB & 44" SLEEPER KITS WITHOUT EXTENSION LONG HOOD MODELS - STAINLESS STEEL

	PANEL WIDTH	BLANK	G4 HOLES			3/4" HOLES		
<b>44" SLEEPERS UNDERBODY EXHAUST</b> (123" BBC) 579 2013+ NO BLOCK HEATER	2.5" WIDE	<b>TP-10160</b>	<b>TP-10163</b> 10 x G4 HOLES	<b>TP-10163LM</b> 10 x TLED-G4A	<b>TP-10163LMC</b> 10 x TLED-G4CA	-	-	-
<b>44" SLEEPERS UNDERBODY EXHAUST</b> (123" BBC) 579 2013+ 1 BLOCK HEATER	2.5" WIDE	<b>TP-10161</b>	<b>TP-10164</b> 10 x G4 HOLES	<b>TP-10164LM</b> 10 x TLED-G4A	<b>TP-10164LMC</b> 10 x TLED-G4CA	-	-	-
<b>44" SLEEPERS UNDERBODY EXHAUST</b> (123" BBC) 579 2013+ 2 BLOCK HEATER	2.5" WIDE	<b>TP-10162</b>	<b>TP-10165</b> 10 x G4 HOLES	<b>TP-10165LM</b> 10 x TLED-G4A	<b>TP-10165LMC</b> 10 x TLED-G4CA	-	-	-

## CAB, 80" SLEEPER & EXTENSION KITS LONG HOOD MODELS - STAINLESS STEEL

	PANEL WIDTH	BLANK	G4 HOLES			3/4" HOLES		
<b>80" SLEEPERS UNDERBODY EXHAUST</b> (123" BBC) 579 2013+ NO BLOCK HEATER	2.5" WIDE	-	<b>TP-10133</b> 18 x G4 HOLES	<b>TP-10133LM</b> 18 x TLED-G4A	<b>TP-10133LMC</b> 18 x TLED-G4CA	-	-	-
<b>80" SLEEPERS UNDERBODY EXHAUST</b> (123" BBC) 579 2013+ 1 BLOCK HEATER	2.5" WIDE	-	<b>TP-10130</b> 18 x G4 HOLES	<b>TP-10130LM</b> 18 x TLED-G4A	<b>TP-10130LMC</b> 18 x TLED-G4CA	-	-	-
<b>80" SLEEPERS UNDERBODY EXHAUST</b> (123" BBC) 579 2013+ 2 BLOCK HEATER	2.5" WIDE	<b>TP-10180</b>	<b>TP-10131</b> 18 x G4 HOLES	<b>TP-10131LM</b> 18 x TLED-G4A	<b>TP-10131LMC</b> 18 x TLED-G4CA	-	-	-

 WARNING: Cancer and Reproductive Harm - [www.p65warnings.ca.gov](http://www.p65warnings.ca.gov)





## CAB, 80" SLEEPER & EXTENSION KITS

LONG HOOD MODELS - STAINLESS STEEL

	PANEL WIDTH	BLANK	G4 HOLES			3/4" HOLES		
<b>80" SLEEPERS CAB EXHAUST</b> (123" BBC) 579 ALL YEARS 1 BLOCK HEATER	3" WIDE	<b>TP-10181</b>	<b>TP-10183</b> 18 x G4 HOLES	<b>TP-10183LM</b> 18 x TLED-G4A	<b>TP-10183LMC</b> 18 x TLED-G4CA	-	-	-
<b>80" SLEEPERS CAB EXHAUST</b> (123" BBC) 579 ALL YEARS 2 BLOCK HEATER	3" WIDE	<b>TP-10182</b>	<b>TP-10143</b> 18 x G4 HOLES	<b>TP-10143LM</b> 18 x TLED-G4A	<b>TP-10143LMC</b> 18 x TLED-G4CA	-	-	-

## CAB, 72" SLEEPER & EXTENSION KITS

LONG HOOD MODELS - STAINLESS STEEL

	PANEL WIDTH	BLANK	G4 HOLES			3/4" HOLES		
<b>72" SLEEPERS UNDERBODY EXHAUST</b> (123" BBC) 579 2013+ NO BLOCK HEATER	2.5" WIDE	-	<b>TP-10115</b> 16 x G4 HOLES	<b>TP-10115LM</b> 16 x TLED-G4A	<b>TP-10115LMC</b> 16 x TLED-G4CA	-	-	-
<b>72" SLEEPERS UNDERBODY EXHAUST</b> (123" BBC) 579 2013+ 1 BLOCK HEATER	2.5" WIDE	<b>TP-10114</b>	<b>TP-10116</b> 16 x G4 HOLES	<b>TP-10116LM</b> 16 x TLED-G4A	<b>TP-10116LMC</b> 16 x TLED-G4CA	-	-	-
<b>72" SLEEPERS UNDERBODY EXHAUST</b> (123" BBC) 579 2013+ 2 BLOCK HEATER	2.5" WIDE	-	<b>TP-10140</b> 16 x G4 HOLES	<b>TP-10140LM</b> 16 x TLED-G4A	<b>TP-10140LMC</b> 16 x TLED-G4CA	-	-	-
<b>72" SLEEPERS CAB EXHAUST</b> (123" BBC) 579 ALL YEARS NO BLOCK HEATER	3" WIDE	<b>TP-10177</b>	<b>TP-10179</b> 18 x G4 HOLES	<b>TP-10179LM</b> 18 x TLED-G4A	<b>TP-10179LMC</b> 18 x TLED-G4CA	-	-	-
<b>72" SLEEPERS CAB EXHAUST</b> (123" BBC) 579 ALL YEARS 1 BLOCK HEATER	3" WIDE	<b>TP-10178</b>	<b>TP-10142</b> 18 x G4 HOLES	<b>TP-10142LM</b> 18 x TLED-G4A	<b>TP-10142LMC</b> 18 x TLED-G4CA	-	-	-



 WARNING: Cancer and Reproductive Harm - [www.p65warnings.ca.gov](http://www.p65warnings.ca.gov)





# PETERBILT 579

## CAB, 44" SLEEPER & EXTENSION KITS LONG HOOD MODELS - STAINLESS STEEL

	PANEL WIDTH	BLANK	G4 HOLES			3/4" HOLES		
<b>44" SLEEPERS UNDERBODY EXHAUST</b> (123" BBC) 579 2013+ NO BLOCK HEATER	2.5" WIDE	<b>TP-10170</b>	<b>TP-10173</b> 14 x G4 HOLES	<b>TP-10173LM</b> 14 x TLED-G4A	<b>TP-10173LMC</b> 14 x TLED-G4CA	-	-	-
<b>44" SLEEPERS UNDERBODY EXHAUST</b> (123" BBC) 579 2013+ 1 BLOCK HEATER	2.5" WIDE	<b>TP-10171</b>	<b>TP-10174</b> 14 x G4 HOLES	<b>TP-10174LM</b> 14 x TLED-G4A	<b>TP-10174LMC</b> 14 x TLED-G4CA	-	-	-
<b>44" SLEEPERS UNDERBODY EXHAUST</b> (123" BBC) 579 2013+ 2 BLOCK HEATER	2.5" WIDE	<b>TP-10172</b>	<b>TP-10175</b> 14 x G4 HOLES	<b>TP-10175LM</b> 14 x TLED-G4A	<b>TP-10175LMC</b> 14 x TLED-G4CA	-	-	-



## CAB, 80" SLEEPER & EXTENSION KITS SHORT HOOD MODELS - STAINLESS STEEL

	PANEL WIDTH	BLANK	G4 HOLES			3/4" HOLES		
<b>80" SLEEPERS UNDERBODY EXHAUST</b> (117" BBC) 579 2013+ 1 BLOCK HEATER	2.5" WIDE	<b>TP-10157</b>	<b>TP-10144</b> 18 x G4 HOLES	<b>TP-10144LM</b> 18 x TLED-G4A	<b>TP-10144LMC</b> 18 x TLED-G4CA	-	-	-
<b>80" SLEEPERS UNDERBODY EXHAUST</b> (117" BBC) 579 2013+ 2 BLOCK HEATER	2.5" WIDE	<b>TP-10158</b>	<b>TP-10159</b> 18 x G4 HOLES	<b>TP-10159LM</b> 18 x TLED-G4A	<b>TP-10159LMC</b> 18 x TLED-G4CA	-	-	-
<b>80" SLEEPERS CAB EXHAUST</b> (117" BBC) 579 2013+ 1 BLOCK HEATER	3" WIDE	<b>TP-10154</b>	<b>TP-10156</b> 18 x G4 HOLES	<b>TP-10156LM</b> 18 x TLED-G4A	<b>TP-10156LMC</b> 18 x TLED-G4CA	-	-	-
<b>80" SLEEPERS CAB EXHAUST</b> (117" BBC) 579 2013+ 2 BLOCK HEATER	3" WIDE	<b>TP-10153</b>	<b>TP-10155</b> 18 x G4 HOLES	<b>TP-10155LM</b> 18 x TLED-G4A	<b>TP-10155LMC</b> 18 x TLED-G4CA	-	-	-

 WARNING: Cancer and Reproductive Harm - [www.p65warnings.ca.gov](http://www.p65warnings.ca.gov)

# CAB, 72" SLEEPER & EXTENSION KITS

SHORT HOOD MODELS - STAINLESS STEEL

	PANEL WIDTH	BLANK	G4 HOLES			3/4" HOLES		
<b>72" SLEEPERS UNDERBODY EXHAUST</b> (117" BBC) 579 2013+ NO BLOCK HEATER	2.5" WIDE	<b>TP-10146</b>	<b>TP-10150</b> 18 x G4 HOLES	<b>TP-10150LM</b> 1186 x TLED-G4A	<b>TP-10150LMC</b> 18 x TLED-G4CA	-	-	-
<b>72" SLEEPERS UNDERBODY EXHAUST</b> (117" BBC) 579 2013+ 1 BLOCK HEATER	2.5" WIDE	<b>TP-10148</b>	<b>TP-10152</b> 18 x G4 HOLES	<b>TP-10152LM</b> 18 x G4 HOLES	<b>TP-10152LMC</b> 18 x G4 HOLES	-	-	-
<b>72" SLEEPERS CAB EXHAUST</b> (117" BBC) 579 2013+ NO BLOCK HEATER	3" WIDE	<b>TP-10145</b>	<b>TP-10149</b> 18 x G4 HOLES	<b>TP-10149LM</b> 18 x TLED-G4A	<b>TP-10149LMC</b> 18 x TLED-G4CA	-	-	-
<b>72" SLEEPERS CAB EXHAUST</b> (117" BBC) 579 2013+ 1 BLOCK HEATER	3" WIDE	<b>TP-10147</b>	<b>TP-10151</b> 18 x G4 HOLES	<b>TP-10151LM</b> 18 x TLED-G4A	<b>TP-10151LMC</b> 18 x TLED-G4CA	-	-	-

**CAN'T FIND WHAT YOU'RE LOOKING FOR?**  
WITH OVER 2000 MORE PRODUCTS ON OUR WEBSITE, YOU'D BE SURE TO FIND WHAT YOU WANT!



**VISIT OUR WEBSITE**  
[TRUXACCESSORIES.COM](http://TRUXACCESSORIES.COM)

# PETERBILT TRIMS

## DOOR WINDOW SHADES WITH MIRROR CUTOUTS | WITHOUT MIRROR CUTOUTS



STAINLESS STEEL  
**TP-1401** With Mirror Cutout



STAINLESS STEEL  
**TP-1402** Without Mirror Cutout



STAINLESS STEEL  
**TP-1431** Without Mirror Cutout

### TECHNICAL SPECIFICATIONS

#### MODELS WITH 1.9M CAB

**TP-1401:** All Cab Mounted Models except NGP Models (2005-2012)

**TP-1402:** All Models (2005+)

**TP-1431:** All Cab Mounted Models except NGP Models (2012+)

WHAT'S INCLUDED	Hardware & 3M Tape (Double Sided)
SOLD	As a Pair
WARRANTY	1 Year

TP-1401 & TP-1431 will not fit NGP Cab Models (387,587,579 & 567).

### WIPER ARM COVERS - ALL YEARS



STAINLESS STEEL  
**TP-0130**

### TECHNICAL SPECIFICATIONS

#### PETERBILT MODELS

**ALL MODELS** (All Years)

WHAT'S INCLUDED	3M Tape (Double Sided)
SOLD	As a Pair
WARRANTY	1 Year

Install with supplied 3M Tape.

### WINDSHIELD CONTOUR & CENTER TRIM - 1987+



STAINLESS STEEL  
**TP-0196**

### TECHNICAL SPECIFICATIONS

#### PETERBILT MODELS

**389, 388, 379, 378, 377, 367,  
340, 335 & 330** (1987+)

WHAT'S INCLUDED	3M Tape (Double Sided)
SOLD	As a Kit (3 Pieces)
WARRANTY	1 Year

Install with supplied 3M Tape.

### REAR SLEEPER WINDOW TRIM - ALL YEARS



STAINLESS STEEL  
**TP-1407**

### TECHNICAL SPECIFICATIONS

#### MODELS WITH 37" WINDOW

**ALL MODELS** (All Years)

WHAT'S INCLUDED	Hardware & 3M Tape (Double Sided)
SOLD	Individually
WARRANTY	1 Year

Install with supplied 3M Tape & Screws.

**WARNING:** Cancer and Reproductive Harm - [www.p65warnings.ca.gov](http://www.p65warnings.ca.gov)

## BATTERY/TOOLBOX PANELS - 1993+



STAINLESS STEEL  
**TP-1602**

### TECHNICAL SPECIFICATIONS

#### PETERBILT MODELS

**ALL MODELS EXCEPT 579** (1993+)

DIMENSIONS	30.44" x 12.75"
WHAT'S INCLUDED	Hardware
SOLD	As a Pair
WARRANTY	1 Year

Install with supplied Hardware.

## 5" WINDOW CHOP TOPS DOOR MOUNTED MIRRORS - ALL YEARS



STAINLESS STEEL  
**TP-1436**

### TECHNICAL SPECIFICATIONS

#### MODELS WITH DOOR MOUNTED MIRRORS

**389, 388, 386, 379, 378** (All Years)

WHAT'S INCLUDED	Hardware
SOLD	As a Pair
WARRANTY	1 Year

Install with supplied Hardware.



STAINLESS STEEL  
**TP-1439** With Flange

## 5" WINDOW CHOP TOPS CAB MOUNTED MIRRORS - ALL YEARS



STAINLESS STEEL  
**TP-1437**



STAINLESS STEEL  
**TP-1438** With Flange



STAINLESS STEEL  
**TP-1446** Convex Mirror Cutout

### TECHNICAL SPECIFICATIONS

#### MODELS WITH CAB MOUNTED MIRRORS

**TP-1437/TP-1438:** 389, 388, 379 & 378 (All Years)

**TP-1446:** 389, 388, 386, 384, 379, 378, 367, 365, 357, 348, 340, 337, 335 & 330 (All Years)

WHAT'S INCLUDED	Hardware
SOLD	As a Pair
WARRANTY	1 Year

Install with supplied Hardware.

**WARNING:** Cancer and Reproductive Harm - [www.p65warnings.ca.gov](http://www.p65warnings.ca.gov)

# PETERBILT TRIMS

## BATTERY & TOOL BOX COVERS



14 GAUGE 304 STAINLESS STEEL  
**TP-1662** Battery & Tool Box Cover Set  
**TP-1662B** Battery Box Cover Only  
**TP-1662T** Tool Box Cover Only

### TECHNICAL SPECIFICATIONS

#### PETERBILT MODELS

**389** (Current Year Gliders) **388** (Pre-2010)  
**379** (1988-2007)

WHAT'S INCLUDED	Hardware
SOLD	TP-1662: As a Kit   TP-1662B/T: Individually
WARRANTY	1 Year

Install with supplied Hardware.

## PASSENGER DOOR WINDOW TRIM - 2005+



STAINLESS STEEL  
**TP-1413**

### TECHNICAL SPECIFICATIONS

#### PETERBILT MODELS

**ALL MODELS** (2005+)

WHAT'S INCLUDED	Silicone
SOLD	Individually
WARRANTY	1 Year

Install with supplied Silicone.

## AIR LINE BOX | COVER - ALL YEARS

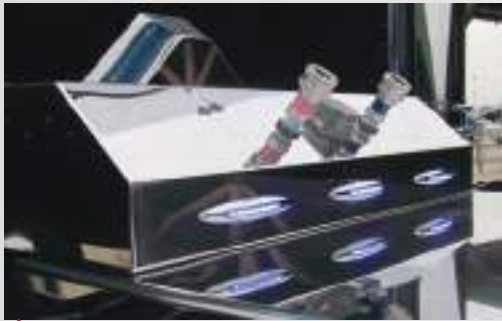

STAINLESS STEEL  
**TP-1645** Box with 3 x FG4 Holes  
**TP-1651** Back Panel

### TECHNICAL SPECIFICATIONS

#### PETERBILT MODELS

**ALL MODELS** (All Years)

WHAT'S INCLUDED	Hardware
SOLD	Individually
WARRANTY	1 Year

Install with supplied Hardware.

## 379/389 LOUVERED HALF MOON STRAIGHT GRILLE BARS - ALL YEARS



STAINLESS STEEL  
**TP-1143** 33.5" Vertical Bar



STAINLESS STEEL  
**TP-1144** 39" Horizontal Bar

### TECHNICAL SPECIFICATIONS

#### PETERBILT MODELS

**379 & 389** (All Years)

DIMENSIONS	TP-1143: 33.5" Long   TP-1144: 39" Long
SOLD	Individually
WARRANTY	1 Year

Install with supplied Hardware.

**WARNING:** Cancer and Reproductive Harm - [www.p65warnings.ca.gov](http://www.p65warnings.ca.gov)

## 379 LONG HOOD LOUVERED STRAIGHT GRILLE BARS - 1987+



STAINLESS STEEL  
**TP-1104** 34" Straight (7 Bars)

### TECHNICAL SPECIFICATIONS

#### LONG HOOD MODELS

**379** (1987+)

WHAT'S INCLUDED	Hardware
SOLD	As a Kit (7 Grille Bars)
WARRANTY	1 Year

Install with supplied Hardware.

## 379 SHORT HOOD LOUVERED STRAIGHT GRILLE BARS - ALL YEARS

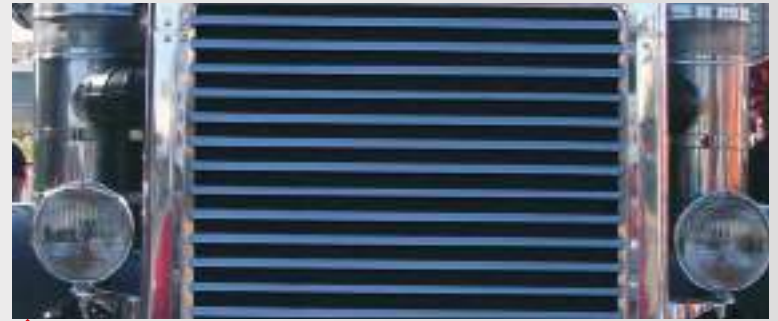

STAINLESS STEEL  
**TP-1002** Straight (15 Bars)

### TECHNICAL SPECIFICATIONS

#### SHORT HOOD MODELS

**379** (All Years)

WHAT'S INCLUDED	Hardware
SOLD	As a Kit (15 Grille Bars)
WARRANTY	1 Year

Install with supplied Hardware.

## 379/359 LONG HOOD LOUVERED STRAIGHT GRILLE BARS - ALL YEARS



STAINLESS STEEL  
**TP-1001** Straight (16 Bars)

### TECHNICAL SPECIFICATIONS

#### LONG HOOD MODELS

**379 & 359** (All Years)

WHAT'S INCLUDED	Hardware
SOLD	As a Kit (16 Grille Bars)
WARRANTY	1 Year

Install with supplied Hardware.

## 379/378/359 LONG HOOD LOUVERED ANGLED GRILLE BARS - ALL YEARS



STAINLESS STEEL  
**TP-1102** Angled (15 Bars)

### TECHNICAL SPECIFICATIONS

#### LONG HOOD MODELS

**379, 378 & 359** (All Years)

WHAT'S INCLUDED	Hardware
SOLD	As a Kit (15 Grille Bars)
WARRANTY	1 Year

Install with supplied Hardware.

# PETERBILT TRIMS

## 379 FRONT FENDER TRIMS ALL YEARS



STAINLESS STEEL  
**TP-1219**

### TECHNICAL SPECIFICATIONS

#### PETERBILT MODELS

**379** (All Years)

WHAT'S INCLUDED	3M Tape (Double Sided)
SOLD	As a Pair
WARRANTY	1 Year

Install with supplied Hardware.

## 379 FENDER GUARDS ALL YEARS



STAINLESS STEEL  
**TP-1201**

### TECHNICAL SPECIFICATIONS

#### PETERBILT MODELS

**379** (All Years)

WHAT'S INCLUDED	Hardware
SOLD	As a Pair
WARRANTY	1 Year

Install with supplied Hardware.

## 379/378 FENDER TRIMS ALL YEARS



STAINLESS STEEL  
**TFT-PET379** Outer Trim



STAINLESS STEEL  
**TFT-PET379F** Inner Trim

### TECHNICAL SPECIFICATIONS

#### LONG/SHORT HOOD MODELS

**379 & 378** (All Years)

WHAT'S INCLUDED	3M Tape (Double Sided)
SOLD	As a Pair
WARRANTY	1 Year

TFT-PET379F is 49.6" Long. Install with supplied 3M Tape.

## 386 AIR INTAKE COVER WITH LOGO - 2007+



STAINLESS STEEL  
**TP-1119** Logo Cutout

### TECHNICAL SPECIFICATIONS

#### PETERBILT MODEL

**386** (2007+)

WHAT'S INCLUDED	Hardware & 3M Tape (Double Sided)
SOLD	Individually
WARRANTY	1 Year

Install with supplied 3M Tape & Hardware.

WARNING: Cancer and Reproductive Harm - [www.p65warnings.ca.gov](http://www.p65warnings.ca.gov)



## 389 FENDER GUARDS - SINGLE HEADLIGHT



STAINLESS STEEL  
**TP-1228**

**TECHNICAL SPECIFICATIONS**

PETERBILT MODEL	
389 (2018+)	

WHAT'S INCLUDED	Hardware
SOLD	As a Kit
WARRANTY	1 Year

Install with supplied Hardware.

## 389/388 HOOD LATCH GUARDS - 2007+



STAINLESS STEEL  
**TP-1112**

**TECHNICAL SPECIFICATIONS**

PETERBILT MODEL	
389, 388 (2007+)	

SOLD	As a Kit
WARRANTY	1 Year

Mounted using existing hardware.

## 389 HOOD EMBLEM STRIPE ACCENTS - 2007+



STAINLESS STEEL  
**TP-1113**

**TECHNICAL SPECIFICATIONS**

LONG HOOD MODEL	
389 131" BBC (2007+)	

WHAT'S INCLUDED	3M Tape (Double Side)
SOLD	As a Kit
WARRANTY	1 Year

Mounted using the existing Emblem Mounting Studs & supplied 3M Tape.

## 389/388 FENDER GUARD SINGLE HEADLIGHT - 2007+



STAINLESS STEEL  
**TP-1210** Blank

**TECHNICAL SPECIFICATIONS**

PETERBILT MODELS	
389 & 388 (2007+)	

WHAT'S INCLUDED	Hardware
SOLD	As a Kit
WARRANTY	1 Year

Install with supplied 3M Tape & Hardware.

## 389/388 FENDER GUTTER TRIMS - 2007+



STAINLESS STEEL  
**TP-1211**

**TECHNICAL SPECIFICATIONS**

PETERBILT MODELS	
389 & 388 (2007+)	

WHAT'S INCLUDED	Hardware & 3M Tape (Double Sided)
SOLD	As a Pair
WARRANTY	1 Year

Drilling is required. Install with supplied 3M Tape & Hardware.

# PETERBILT TRIMS

## 389/388 FENDER TRIMS 2008+



STAINLESS STEEL  
**TFT-PET389**

### TECHNICAL SPECIFICATIONS

#### PETERBILT MODELS

**389 & 388** (2008+)

WHAT'S INCLUDED	3M Tape (Double Sided)
SOLD	As a Pair
WARRANTY	1 Year

Install with supplied 3M Tape.

## 389/388 BATTERY TOOLBOX PANELS - 2007+



STAINLESS STEEL  
**TP-1606**

### TECHNICAL SPECIFICATIONS

#### PETERBILT MODELS

**389 & 388** (2007+)

WHAT'S INCLUDED	Hardware
SOLD	As a Pair
WARRANTY	1 Year

Install with supplied Hardware.

## 389/388 LICENSE/TAG SWING PLATES SINGLE / DOUBLE / TRIPLE - 2007+



STAINLESS STEEL  
**TP-1701** 1 Plate



STAINLESS STEEL  
**TP-1702** 2 Plates



STAINLESS STEEL  
**TP-1703** 3 Plates

### TECHNICAL SPECIFICATIONS

#### PETERBILT MODELS

**389 & 388** (2007+)

GAUGE	18 Gauge
WHAT'S INCLUDED	Hardware & Bezels
SOLD	As a Kit
WARRANTY	1 Year

Install using existing bumper mounting bolts on bumper face. Does not require drilling.

WARNING: Cancer and Reproductive Harm - [www.p65warnings.ca.gov](http://www.p65warnings.ca.gov)

## 579 FENDER TRIMS

LONG HOOD - ALL YEARS



STAINLESS STEEL  
**TFT-PET579**

**TECHNICAL SPECIFICATIONS**

**LONG HOOD MODELS**

**579** 123" BBC (All Years)

WHAT'S INCLUDED	3M Tape (Double Sided)
SOLD	As a Kit (4 Pieces)
WARRANTY	1 Year

Install with supplied 3M Tape.

## 579 HEADLIGHT TRIMS

2013+



STAINLESS STEEL  
**TP-1218**

**TECHNICAL SPECIFICATIONS**

**PETERBILT MODEL**

**579** (2013+)

WHAT'S INCLUDED	Hardware & 3M Tape (Double Side)
SOLD	As a Pair
WARRANTY	1 Year

Install with supplied 3M Tape.

## 579 SIDE HOOD TRIMS

LONG HOOD - ALL YEARS

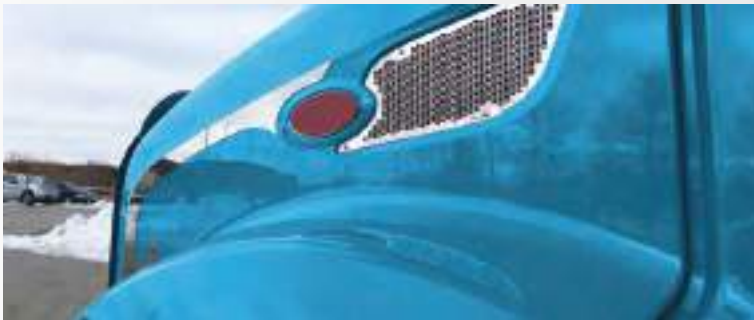

STAINLESS STEEL  
**TP-1129**

**TECHNICAL SPECIFICATIONS**

**LONG HOOD MODELS**

**579** 123" BBC (All Years)

WHAT'S INCLUDED	3M Tape (Double Side)
SOLD	As a Pair
WARRANTY	1 Year

Install with supplied 3M Tape.

## 579 DOOR WINDOW TRIMS

ALL YEARS



STAINLESS STEEL  
**TP-1434**

**TECHNICAL SPECIFICATIONS**

**PETERBILT MODEL**

**579** (All Years)

WHAT'S INCLUDED	3M Tape (Double Side)
SOLD	As a Pair
WARRANTY	1 Year

Install with supplied 3M Tape.

# PETERBILT TRIMS

## 579 STEP TRIMS LOWER BACK | UPPER BACK | FRONT

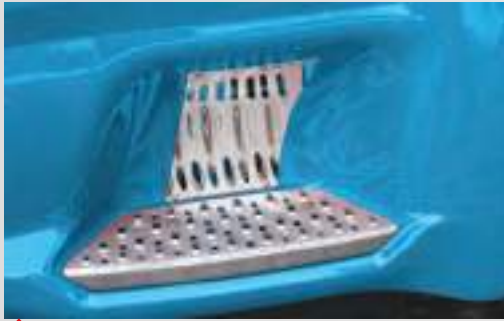

STAINLESS STEEL  
**TP-1643** Lower Back Step



STAINLESS STEEL  
**TP-1646** Upper Back Step



STAINLESS STEEL  
**TP-1648** Front Step

### TECHNICAL SPECIFICATIONS

#### PETERBILT MODEL

**TP-1643:** 579 (All Years) **TP-1646:** 579 (2013+)  
**TP-1648:** 579 (2013+)

WHAT'S INCLUDED	Hardware & 3M Tape (Double Sided)
SOLD	As a Pair
WARRANTY	1 Year

Install with supplied 3M Tape & Hardware.

## 579 AIR INTAKE GRILLE TRIMS - 2013+



STAINLESS STEEL  
**TP-1123**

### TECHNICAL SPECIFICATIONS

#### PETERBILT MODEL

**579** (2013+)

WHAT'S INCLUDED	Hardware & 3M Tape (Double Side)
SOLD	As a Pair
WARRANTY	1 Year

Install with supplied 3M Tape & Hardware.

## 579/567 DOOR HANDLE TRIMS - ALL YEARS



STAINLESS STEEL  
**TP-1433**

### TECHNICAL SPECIFICATIONS

#### PETERBILT MODELS

**579 & 567** (All Years)

WHAT'S INCLUDED	3M Tape (Double Side)
SOLD	As a Pair
WARRANTY	1 Year

Install with supplied 3M Tape & Hardware.

WARNING: Cancer and Reproductive Harm - [www.p65warnings.ca.gov](http://www.p65warnings.ca.gov)

## 579/567 DOOR WINDOW TRIMS - ALL YEARS



STAINLESS STEEL  
**TP-1445**

### TECHNICAL SPECIFICATIONS

#### PETERBILT MODELS

**579 & 567** (All Years)

WHAT'S INCLUDED	3M Tape (Double Side)
SOLD	As a Pair
WARRANTY	1 Year

Install with supplied 3M Tape.

## 579/567 DOOR WINDOW SHADES - 2013+



STAINLESS STEEL  
**TP-1440**

### TECHNICAL SPECIFICATIONS

#### MODELS WITH/WITHOUT PASSENGER MIRROR

**579 & 567** (All Years)

WHAT'S INCLUDED	Hardware & 3M Tape (Double Side)
SOLD	As a Pair
WARRANTY	1 Year

Install with supplied 3M Tape & Hardware.

## 579/567 CAB DOOR CONTOUR TRIMS - ALL YEARS



STAINLESS STEEL  
**TP-1444**

### TECHNICAL SPECIFICATIONS

#### PETERBILT MODELS

**579 & 567** (All Years)

WHAT'S INCLUDED	3M Tape (Double Side)
SOLD	As a Pair
WARRANTY	1 Year

Install with supplied 3M Tape.

## 587 AIR INTAKE GRILLE TRIMS - 2011+



STAINLESS STEEL  
**TP-1128**

### TECHNICAL SPECIFICATIONS

#### PETERBILT MODEL

**587** (2011+)

WHAT'S INCLUDED	Hardware & 3M Tape (Double Sided)
SOLD	As a Pair
WARRANTY	1 Year

Install with supplied 3M Tape & Hardware.

# KENWORTH SUN VISORS

## 11" CURVED GLASS SUN VISOR - 1998-2006



STAINLESS STEEL  
**TSUN-K4**

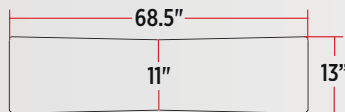

### TECHNICAL SPECIFICATIONS

#### CURVED WINDSHIELD MODELS

**W900B, W900L & T800** (1998-2006)

DIMENSIONS	Width: 68.5"   Sides: 13"   Drop: 11"
WHAT'S INCLUDED	3 x Sun Visor Brackets & Hardware
WARRANTY	1 Year

Trux's definition of a Curved Glass Windshield is that on both passenger & driver sides near the doors, the Windshield curves approximately three inches towards the back of the truck. Will fit a 1 Piece or 2 Piece Windshield. Will not replace Fiberglass Sun Visor. Visit our website at [www.truxaccessories.com](http://www.truxaccessories.com) for Installation Instructions.

## 12" CURVED GLASS SUN VISOR - 2008+



STAINLESS STEEL  
**TSUN-K14** Blank  
**TSUN-K13** 5 x OEM Holes

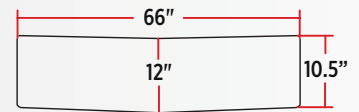

### TECHNICAL SPECIFICATIONS

#### CURVED WINDSHIELD MODELS

**T660, T800 & W900** (2008+)

DIMENSIONS	Width: 66"   Sides: 10.5"   Drop: 12"
WHAT'S INCLUDED	3 x Sun Visor Brackets & Hardware
WARRANTY	1 Year

TSUN-K13: OEM replacement for the composite lighted visor. Visit our website at [www.truxaccessories.com](http://www.truxaccessories.com) for Installation Instructions.

## 13" BOLTESS BOWTIE CURVED GLASS SUN VISOR - 1995+



STAINLESS STEEL  
**TSUN-K6**

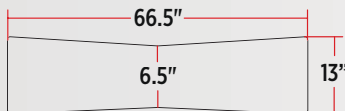

### TECHNICAL SPECIFICATIONS

#### CURVED WINDSHIELD MODELS

**KENWORTH AEROCAB MODELS** (1995+)

DIMENSIONS	Width: 66.5"   Sides: 13"   Drop: 6.5"
WHAT'S INCLUDED	8 x Sun Visor Brackets & Hardware
WARRANTY	1 Year

Trux's definition of a Curved Glass Windshield is that on both passenger & driver sides near the doors, the Windshield curves approximately three inches towards the back of the truck. Designed to replace OEM Sun Visor. Visit our website at [www.truxaccessories.com](http://www.truxaccessories.com) for Installation Instructions.

## 14" CURVED GLASS SUN VISOR - PRE-2007



STAINLESS STEEL  
**TSUN-K1** Blank  
**TSUN-K2** 8 x 2" Holes

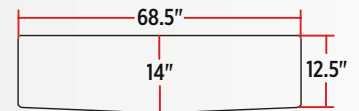

### TECHNICAL SPECIFICATIONS

#### CURVED WINDSHIELD MODELS

**T800, W900B & W900L** (Pre-2007)

DIMENSIONS	Width: 68.5"   Sides: 12.5"   Drop: 14"
WHAT'S INCLUDED	5 x Sun Visor Brackets & Hardware
WARRANTY	1 Year

Trux's definition of a Curved Glass Windshield is that on both passenger & driver sides near the doors, the Windshield curves approximately three inches towards the back of the truck. Will fit a 1 Piece or 2 Piece Windshield. Will not replace Fiberglass Sun Visor. Visit our website at [www.truxaccessories.com](http://www.truxaccessories.com) for Installation Instructions.

**WARNING: Cancer and Reproductive Harm - [www.p65warnings.ca.gov](http://www.p65warnings.ca.gov)**

## 14" CURVED GLASS STANDARD CAB SUN VISOR - 2007+



STAINLESS STEEL  
**TSUN-K5**

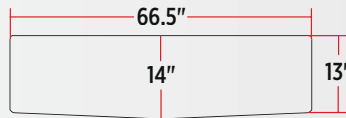

**TECHNICAL SPECIFICATIONS**

**CURVED WINDSHIELD MODELS**

**W900B, W900L, T800, T660 & T600 (2007+)**

DIMENSIONS	Width: 66.5"   Sides: 13"   Drop: 14"
WHAT'S INCLUDED	5 x Sun Visor Brackets & Hardware
WARRANTY	1 Year

Trux's definition of a Curved Glass Windshield is that on both passenger & driver sides near the doors, the Windshield curves approximately three inches towards the back of the truck. Will fit a 1 Piece or 2 Piece Windshield. Will not replace Fiberglass Sun Visor. Visit our website at [www.truxaccessories.com](http://www.truxaccessories.com) for Installation Instructions.

## 11" FLAT GLASS SUN VISOR - 1988-2005



STAINLESS STEEL  
**TSUN-K12**

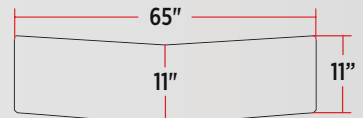

**TECHNICAL SPECIFICATIONS**

**FLAT WINDSHIELD MODELS**

**T600, T800, W900B & W900L (1988-2005)**

DIMENSIONS	Width: 65"   Sides: 11"   Drop: 11"
WHAT'S INCLUDED	3 x Sun Visor Brackets & Hardware
WARRANTY	1 Year

Trux's definition of Flat Glass Windshield is that on both passenger and driver sides near the doors, the Windshield is perfectly straight. Will fit a 1 Piece or 2 Piece Windshield. Will not replace Fiberglass Sun Visor. Visit our website at [www.truxaccessories.com](http://www.truxaccessories.com) for Installation Instructions.

## 13" FLAT GLASS STANDARD CAB SUN VISOR - 2007+



STAINLESS STEEL  
**TSUN-K11**



**TECHNICAL SPECIFICATIONS**

**FLAT WINDSHIELD MODELS**

**ALL KENWORTH MODELS (2007+)**

DIMENSIONS	Width: 68"   Sides: 12"   Drop: 13"
WHAT'S INCLUDED	5 x Sun Visor Brackets & Hardware
WARRANTY	1 Year

Replaces OEM 2 Piece Sun Visor. Visit our website at [www.truxaccessories.com](http://www.truxaccessories.com) for Installation Instructions.

## 15" FLAT GLASS SUN VISOR - PRE-2007



STAINLESS STEEL  
**TSUN-K8**

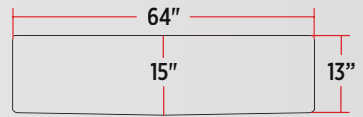

**TECHNICAL SPECIFICATIONS**

**FLAT WINDSHIELD MODELS**

**T800, W900B & W900L (Pre-2007)**

DIMENSIONS	Width: 64"   Sides: 13"   Drop: 15"
WHAT'S INCLUDED	3 x Sun Visor Brackets & Hardware
WARRANTY	1 Year

Trux's definition of Flat Glass Windshield is that on both passenger and driver sides near the doors, the Windshield is perfectly straight. Will fit a 1 Piece or 2 Piece Windshield. Will not replace Fiberglass Sun Visor. Visit our website at [www.truxaccessories.com](http://www.truxaccessories.com) for Installation Instructions.

# KENWORTH SUN VISORS

## 8.5" HIGH ROOF SUN VISOR - 2012+



STAINLESS STEEL  
**TSUN-K20**

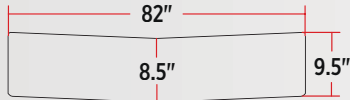

### TECHNICAL SPECIFICATIONS

#### HIGH ROOF SLEEPER MODELS

**T680 & T880** (2012+)

DIMENSIONS	Width: 82"   Sides: 9.5"   Drop: 8.5"
WHAT'S INCLUDED	4 x Sun Visor Brackets & Hardware
WARRANTY	1 Year

Visit our website at [www.truxaccessories.com](http://www.truxaccessories.com) for Installation Instructions.

## 8.5" DAY CAB SUN VISOR - 2012+



OEM METAL  
**TSUN-K21**

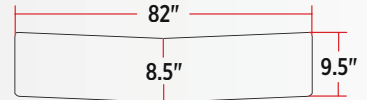

### TECHNICAL SPECIFICATIONS

#### DAY CAB MODELS WITH OEM SUN VISOR

**T680 & T880** (2012+)

DIMENSIONS	Width: 82"   Sides: 9.5"   Drop: 8.5"
WHAT'S INCLUDED	3 x Sun Visor Brackets & Hardware
WARRANTY	1 Year

For Models with OEM Metal Sun Visor. Visit our website at [www.truxaccessories.com](http://www.truxaccessories.com) for Installation Instructions.

## 11.5" BOLTLESS DAY CAB SUN VISOR - 2013-2015



STAINLESS STEEL  
**TSUN-K23** Blank  
**TSUN-K45** 18 x 3/4" Holes

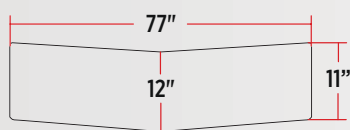

### TECHNICAL SPECIFICATIONS

#### LOW ROOF DAY CAB MODELS

**T680 & T880** (2013-2015)

DIMENSIONS	Width: 77"   Sides: 11"   Drop: 12"
WHAT'S INCLUDED	5 x Sun Visor Brackets & Hardware
WARRANTY	1 Year

Replaces the OEM Stainless Steel Visor. Fits 2016+ Models if installed with OEM Brackets. 2 Piece Sun Visor. Visit our website at [www.truxaccessories.com](http://www.truxaccessories.com) for Installation Instructions.

## 11.5" DAY CAB SUN VISOR - 2012+



STAINLESS STEEL  
**TSUN-K22**

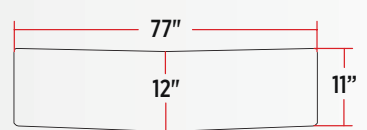

### TECHNICAL SPECIFICATIONS

#### LOW ROOF DAY CAB MODELS

**T680 & T880** (2012+)

DIMENSIONS	Width: 77"   Sides: 11"   Drop: 12"
WHAT'S INCLUDED	5 x Sun Visor Brackets & Hardware
WARRANTY	1 Year

For Models WITHOUT an existing OEM Visor. 2 Piece Sun Visor. Visit our website at [www.truxaccessories.com](http://www.truxaccessories.com) for Installation Instructions.

WARNING: Cancer and Reproductive Harm - [www.p65warnings.ca.gov](http://www.p65warnings.ca.gov)



## W900B BUG DEFLECTOR HOOD SHIELD - 1967+



STAINLESS STEEL  
**THOD-KW900B**

### TECHNICAL SPECIFICATIONS

#### KENWORTH MODEL

**W900B** (1967+)

DIMENSIONS	Width: 48"
WHAT'S INCLUDED	Hardware
WARRANTY	1 Year

Visit our website at [www.truxaccessories.com](http://www.truxaccessories.com) for Installation Instructions.

## W900L BUG DEFLECTOR HOOD SHIELD - 1989+



STAINLESS STEEL  
**THOD-KW900L**

### TECHNICAL SPECIFICATIONS

#### KENWORTH MODEL

**W900L** (1989+)

DIMENSIONS	Width: 43"
WHAT'S INCLUDED	Hardware
WARRANTY	1 Year

Visit our website at [www.truxaccessories.com](http://www.truxaccessories.com) for Installation Instructions.

## T680 BUG DEFLECTOR HOOD SHIELD - ALL YEARS



STAINLESS STEEL  
**THOD-KWT680**

### TECHNICAL SPECIFICATIONS

#### KENWORTH MODEL

**T680** (All Years)

DIMENSIONS	Width: 56.63"
WHAT'S INCLUDED	Hardware
WARRANTY	1 Year

Drilling of mounting holes through fiberglass hood is required. Visit our website at [www.truxaccessories.com](http://www.truxaccessories.com) for Installation Instructions.

## T800 BUG DEFLECTOR HOOD SHIELD - 1987+



STAINLESS STEEL  
**THOD-KWT800**

### TECHNICAL SPECIFICATIONS

#### KENWORTH MODEL

**T800** (1987+)

DIMENSIONS	Width: 48"
WHAT'S INCLUDED	Hardware
WARRANTY	1 Year

Visit our website at [www.truxaccessories.com](http://www.truxaccessories.com) for Installation Instructions.

# KENWORTH BUG DEFLECTORS

## T660 BUG DEFLECTOR HOOD SHIELD - 2006-2017



STAINLESS STEEL  
**THOD-KWT660**

### TECHNICAL SPECIFICATIONS

#### KENWORTH MODEL

**T660** (2006-2017)

DIMENSIONS	Width: 37.5"
WHAT'S INCLUDED	Hardware
WARRANTY	1 Year

Visit our website at [www.truxaccessories.com](http://www.truxaccessories.com) for Installation Instructions.

## T880 BUG DEFLECTOR HOOD SHIELD - 2012+



STAINLESS STEEL  
**THOD-KWT880**

### TECHNICAL SPECIFICATIONS

#### KENWORTH MODEL

**T880** (2012+)

DIMENSIONS	Width: 54.6"
WHAT'S INCLUDED	Hardware
WARRANTY	1 Year

Visit our website at [www.truxaccessories.com](http://www.truxaccessories.com) for Installation Instructions.

## T600 BUG DEFLECTOR HOOD SHIELD - 1996-2006



STAINLESS STEEL  
**THOD-KWT600**

### TECHNICAL SPECIFICATIONS

#### KENWORTH MODEL

**T600** (1996-2006)

DIMENSIONS	Width: 42"
WHAT'S INCLUDED	Hardware
WARRANTY	1 Year

Visit our website at [www.truxaccessories.com](http://www.truxaccessories.com) for Installation Instructions.

## T2000 BUG DEFLECTOR HOOD SHIELD - 1997-2010



STAINLESS STEEL  
**THOD-KWT2000**

### TECHNICAL SPECIFICATIONS

#### KENWORTH MODEL

**T2000** (1997-2010)

DIMENSIONS	Width: 55.5"
WHAT'S INCLUDED	Hardware
WARRANTY	1 Year

Visit our website at [www.truxaccessories.com](http://www.truxaccessories.com) for Installation Instructions.

**WARNING: Cancer and Reproductive Harm - [www.p65warnings.ca.gov](http://www.p65warnings.ca.gov)**

**T370/T270/T170 BUG DEFLECTOR**  
HOOD SHIELD - 2008+



STAINLESS STEEL  
**THOD-KW70**

**TECHNICAL SPECIFICATIONS**

**KENWORTH MODELS**

**T370, T270 & T170** (2008+)

DIMENSIONS	Width: 48.2"
WHAT'S INCLUDED	Hardware
WARRANTY	1 Year

Visit our website at [www.truxaccessories.com](http://www.truxaccessories.com) for Installation Instructions.

**T300 BUG DEFLECTOR**  
HOOD SHIELD - 2005-2007



STAINLESS STEEL  
**THOD-KWT300**

**TECHNICAL SPECIFICATIONS**

**KENWORTH MODEL**

**T300** (2005-2007)

DIMENSIONS	Width: 46.6"
WHAT'S INCLUDED	Hardware
WARRANTY	1 Year

Visit our website at [www.truxaccessories.com](http://www.truxaccessories.com) for Installation Instructions.

**CAN'T FIND WHAT YOU'RE LOOKING FOR?**  
WITH OVER 2000 MORE PRODUCTS ON OUR WEBSITE, YOU'D  
BE SURE TO FIND WHAT YOU WANT!



**VISIT OUR WEBSITE**  
**TRUXACCESSORIES.COM**

# KENWORTH T680







- 430 Mirror Shine Stainless Steel
- LED Lighting
- 1 Year Warranty

- Hardware Included
- Sold as a Pre-Wired & Assembled Kit\*

\*Depending on Part Number

## CAB PANELS STAINLESS STEEL

	PANEL WIDTH	BLANK	G4 HOLES			3/4" HOLES		
<b>SINGLE EXHAUST</b> T680 & T880 2013+ NO BLOCK HEATER	3.82" WIDE	<b>TK-13100</b>	<b>TK-13101</b> 4 x G4 HOLES	<b>TK-13101LM</b> 4 x TLED-G4A	<b>TK-13101LMC</b> 4 x TLED-G4CA	-	-	-
<b>SINGLE EXHAUST</b> T680 & T880 2013+ 1 BLOCK HEATER	3.52" WIDE	<b>TK-13104</b>	-	-	-	-	-	-
<b>DUAL EXHAUST</b> T680 & T880 ALL YEARS 1 BLOCK HEATER	5" WIDE	<b>TK-13102</b>	-	-	-	<b>TK-13103</b> 12 x 3/4" HOLES	<b>TK-13103L</b> 12 x TLED-B2A	<b>TK-13103LC</b> 12 x TLED-B2CA
<b>DUAL EXHAUST</b> T680 & T880 ALL YEARS 2 BLOCK HEATER	5" WIDE	<b>TK-13105</b>	<b>TK-13106</b> 4 x G4 HOLES	<b>TK-13106LM</b> 4 x TLED-G4A	<b>TK-13106LMC</b> 4 x TLED-G4CA	<b>TK-13107</b> 12 x 3/4" HOLES	<b>TK-13107L</b> 12 x TLED-B2A	<b>TK-13107LC</b> 12 x TLED-B2CA

NO Drilling is Required. Install with existing hardware.

Drilling is Required. Install with supplied Hardware.

 WARNING: Cancer and Reproductive Harm - [www.p65warnings.ca.gov](http://www.p65warnings.ca.gov)

## TRANSITION PANELS STAINLESS STEEL

	PANEL WIDTH	BLANK	G4 HOLES			3/4" HOLES		
<b>HIGH ROOF 76" SLEEPER</b> T680 ALL YEARS	3.27" WIDE	-	<b>TK-1682</b> 2 x G4 HOLES	<b>TK-1682LM</b> 2 x TLED-G4A	<b>TK-1682LMC</b> 2 x TLED-G4CA	-	-	-

## CAB, SLEEPER & EXTENSION KITS STAINLESS STEEL

	PANEL WIDTH	BLANK	G4 HOLES			3/4" HOLES		
<b>HIGH ROOF 76" SLEEPER</b> UNDERMOUNT EXHAUST WITH TRANSITION PANEL T680 2013+ NO BLOCK HEATER	2.5" WIDE	<b>TK-1033</b>	<b>TK-1035</b> 16 x G4 HOLES	<b>TK-1035LM</b> 16 x TLED-G4A	<b>TK-1035LMC</b> 16 x TLED-G4CA	<b>TK-1074</b> 40 x 3/4" HOLES	<b>TK-1074L</b> 40 x TLED-B2A	<b>TK-1074LC</b> 40 x TLED-B2CA
<b>HIGH ROOF 76" SLEEPER</b> UNDERMOUNT EXHAUST WITH TRANSITION PANEL T680 2013+ 1 BLOCK HEATER	2.5" WIDE	<b>TK-1032</b>	<b>TK-1034</b> 16 x G4 HOLES	<b>TK-1034LM</b> 16 x TLED-G4A	<b>TK-1034LMC</b> 16 x TLED-G4CA	<b>TK-1086</b> 40 x 3/4" HOLES	<b>TK-1086L</b> 40 x TLED-B2A	<b>TK-1086LC</b> 40 x TLED-B2CA

<b>MID ROOF 76" SLEEPER</b> UNDERMOUNT EXHAUST WITH TRANSITION PANEL T680 ALL YEARS NO BLOCK HEATER	2.5" WIDE	<b>TK-1087</b>	<b>TK-1088</b> 14 x G4 HOLES	<b>TK-1088LM</b> 14 x TLED-G4A	<b>TK-1088LMC</b> 14 x TLED-G4CA	<b>TK-1089</b> 38 x 3/4" HOLES	<b>TK-1089L</b> 38 x TLED-B2A	<b>TK-1089LC</b> 38 x TLED-B2CA
<b>MID ROOF 76" SLEEPER</b> UNDERMOUNT EXHAUST WITH TRANSITION PANEL T680 ALL YEARS 1 BLOCK HEATER	2.5" WIDE	<b>TK-1090</b>	<b>TK-1091</b> 14 x G4 HOLES	<b>TK-1091LM</b> 14 x TLED-G4A	<b>TK-1091LMC</b> 14 x TLED-G4CA	<b>TK-1092</b> 38 x 3/4" HOLES	<b>TK-1092L</b> 38 x TLED-B2A	<b>TK-1092LC</b> 38 x TLED-B2CA

<b>MID ROOF 52" SLEEPER</b> UNDERMOUNT EXHAUST T680 2014+ NO BLOCK HEATER	2.5" WIDE	<b>TK-1055</b>	<b>TK-1057</b> 10 x G4 HOLES	<b>TK-1057LM</b> 10 x TLED-G4A	<b>TK-1057LMC</b> 10 x TLED-G4CA	-	-	-
<b>MID ROOF 52" SLEEPER</b> UNDERMOUNT EXHAUST T680 2014+ 1 BLOCK HEATER	2.5" WIDE	<b>TK-1056</b>	<b>TK-1058</b> 10 x G4 HOLES	<b>TK-1058LM</b> 10 x TLED-G4A	<b>TK-1058LMC</b> 10 x TLED-G4CA	-	-	-

Drilling is Required. Install with supplied Hardware.

# KENWORTH T660



- 430 Mirror Shine Stainless Steel
- LED Lighting
- 1 Year Warranty

- Hardware Included
- Sold as a Pre-Wired & Assembled Kit\*

\*Depending on Part Number

## CAB, SLEEPER & EXTENSION KITS STAINLESS STEEL

	PANEL WIDTH	BLANK	INFINITY HOLES			3/4" HOLES		
<b>72" SLEEPER WITH CHASSIS FAIRING</b> T660 2013+ 1 BLOCK HEATER	3.25" WIDE	<b>TK-1037</b>	<b>TK-1038</b> 22 x INFINITY HOLES	<b>TK-1038L</b> 22 x TLED-INF2A	<b>TK-1038LC</b> 22 x TLED-INF2CA	<b>TK-1093</b> 30 x 3/4" HOLES	<b>TK-1093L</b> 30 x TLED-B2A	<b>TK-1093LC</b> 30 x TLED-B2CA

Install with supplied Hardware.



 WARNING: Cancer and Reproductive Harm - [www.p65warnings.ca.gov](http://www.p65warnings.ca.gov)



- 430 Mirror Shine Stainless Steel
- LED Lighting
- 1 Year Warranty

- Hardware Included
- Sold as a Pre-Wired & Assembled Kit\*

\*Depending on Part Number

## FRONT AIR CLEANER LIGHT BARS STAINLESS STEEL

	PANEL SIZE	G2 HOLES			3/4" HOLES		
<b>FRONT STANDARD AIR CLEANERS W900L 1982+</b>	21.77" LONG 6" MOUNT	<b>TK-1844</b> 14 x G2 HOLES	<b>TK-1844LM</b> 14 x TLED-G2A	<b>TK-1844LMC</b> 14 x TLED-G2CA	<b>TK-1848</b> 12 x 3/4" HOLES	<b>TK-1848L</b> 12 x TLED-B2A	<b>TK-1848LC</b> 12 x TLED-B2CA
<b>FRONT PREMIUM AIR CLEANERS W900 2010+</b>	22.38" LONG 5.25" MOUNT	<b>TK-1814</b> 14 x G2 HOLES	<b>TK-1814LM</b> 14 x TLED-G2A	<b>TK-1814LMC</b> 14 x TLED-G2CA	<b>TK-1852</b> 16 x 3/4" HOLES	<b>TK-1852L</b> 16 x TLED-B2A	<b>TK-1852LC</b> 16 x TLED-B2CA

Attaches to the brackets between the Cab & Air Cleaner with existing hardware.

## REAR AIR CLEANER LIGHT BARS STAINLESS STEEL

	PANEL SIZE	G2 HOLES			3/4" HOLES		
<b>REAR 13/15" STANDARD AIR CLEANERS W900L 1982+</b>	21.88" LONG 6.35" MOUNT	<b>TK-1845</b> 14 x G2 HOLES	<b>TK-1845LM</b> 14 x TLED-G2R	<b>TK-1845LMC</b> 14 x TLED-G2CR	-	-	-
<b>REAR 13/15" STANDARD AIR CLEANERS KENWORTH MODELS ALL YEARS</b>	19.75" LONG 4" MOUNT	-	-	-	<b>TK-1858</b> 12 x 3/4" HOLES	<b>TK-1858L</b> 12 x TLED-B2R	<b>TK-1858LC</b> 12 x TLED-B2CR
<b>REAR PREMIUM AIR CLEANERS W900 2010+</b>	22.38" LONG 5.25" MOUNT	<b>TK-1815</b> 14 x G2 HOLES	<b>TK-1815LM</b> 14 x TLED-G2R	<b>TK-1815LMC</b> 14 x TLED-G2CR	<b>TK-1853</b> 16 x 3/4" HOLES	<b>TK-1853L</b> 16 x TLED-B2R	<b>TK-1853LC</b> 16 x TLED-B2CR

Attaches to the brackets between the Cab & Air Cleaner with existing hardware.

# KENWORTH W900





- 430 Mirror Shine Stainless Steel
- LED Lighting
- 1 Year Warranty

- Hardware Included
- Sold as a Pre-Wired & Assembled Kit\*

\*Depending on Part Number

## LOWER HOOD PANELS STAINLESS STEEL

	PANEL WIDTH	BLANK	G4 HOLES			3/4" HOLES		
<b>1989+</b> W900L	-	<b>TK-1106</b>	-	-	-	-	-	-
<b>1989+</b> W900	-	<b>TK-1127</b>	-	-	-	-	-	-



Replaces OEM Panel behind the Front Fender.



 WARNING: Cancer and Reproductive Harm - [www.p65warnings.ca.gov](http://www.p65warnings.ca.gov)



## CAB PANELS STAINLESS STEEL

	PANEL WIDTH	BLANK	G4 HOLES			3/4" HOLES		
<b>UNDERBODY DPF</b> AEROCAB W900L 2011+ NO BLOCK HEATER	6.57" WIDE DRIVER SIDE	<b>TK-13108</b>	<b>TK-1387</b> 6 x G4 HOLES	<b>TK-1387LM</b> 6 x TLED-G4A	<b>TK-1387LMC</b> 6 x TLED-G4CA	-	-	-

Passenger Side is 5.12" Wide & 51.67" Long. Will NOT fit Day Cab Models due to Exhaust. Install with supplied Hardware.

<b>STEP DPF</b> AEROCAB W900L 2011+ 1 BLOCK HEATER	6.57" WIDE DRIVER SIDE	<b>TK-13109</b>	<b>TK-1377</b> 6 x G4 HOLES	<b>TK-1377LM</b> 6 x TLED-G4A	<b>TK-1377LMC</b> 6 x TLED-G4CA	<b>TK-13112</b> 14 x 3/4" HOLES	<b>TK-13112L</b> 14 x TLED-B2A	<b>TK-13112LC</b> 14 x TLED-B2CA
<b>STEP DPF WITH COURTESY LIGHT CUTOUT</b> W900L 2011+ 1 BLOCK HEATER	6.57" WIDE DRIVER SIDE	<b>TK-13110</b>	<b>TK-13111</b> 6 x G4 HOLES	<b>TK-13111LM</b> 6 x TLED-G4A	<b>TK-13111LMC</b> 6 x TLED-G4CA	-	-	-

Passenger Side is 5.12" Wide & 51.67" Long. Will NOT fit Day Cab Models due to Exhaust. Install with supplied Hardware.

## SLEEPER PANELS WITHOUT EXTENSION STAINLESS STEEL

	PANEL WIDTH	BLANK	G4 HOLES			3/4" HOLES		
<b>72" SLEEPER</b> SIDE MOUNT EXHAUST AEROCAB W900 EPA 2007+	3.5" WIDE	<b>TK-1501</b>	<b>TK-1502</b> 8 x G4 HOLES	<b>TK-1502LM</b> 8 x TLED-G4A	<b>TK-1502LMC</b> 8 x TLED-G4CA	<b>TK-1578</b> 14 x 3/4" HOLES	<b>TK-1578L</b> 18 x TLED-B2A	<b>TK-1578LC</b> 18 x TLED-B2CA

<b>62" SLEEPER</b> SIDE MOUNT EXHAUST AEROCAB W900 EPA 2007+	3.5" WIDE	<b>TK-1513</b>	<b>TK-1514</b> 6 x G4 HOLES	<b>TK-1514LM</b> 6 x TLED-G4A	<b>TK-1514LMC</b> 6 x TLED-G4CA	<b>TK-1565</b> 14 x 3/4" HOLES	<b>TK-1565L</b> 14 x TLED-B2A	<b>TK-1565LC</b> 14 x TLED-B2CA
--	-----------	----------------	--------------------------------	----------------------------------	------------------------------------	-----------------------------------	----------------------------------	------------------------------------

Install with supplied Hardware.

## SLEEPER PANELS WITH EXTENSION STAINLESS STEEL

	PANEL WIDTH	BLANK	G4 HOLES			3/4" HOLES		
<b>72" SLEEPER</b> SIDE MOUNT EXHAUST AEROCAB W900L EPA 2007+	3.5" WIDE	<b>TK-1503</b>	<b>TK-1504</b> 10 x G4 HOLES	<b>TK-1504LM</b> 10 x TLED-G4A	<b>TK-1504LMC</b> 10 x TLED-G4CA	-	-	-
<b>72" SLEEPER</b> SIDE MOUNT EXHAUST AEROCAB W900 2007+	3.5" WIDE	-	-	-	-	<b>TK-1566</b> 24 x 3/4" HOLES	<b>TK-1566L</b> 24 x TLED-B2A	<b>TK-1566LC</b> 24 x TLED-B2CA

<b>62" SLEEPER</b> SIDE MOUNT EXHAUST AEROCAB W900 EPA 2007+	3.5" WIDE	<b>TK-1515</b>	<b>TK-1579</b> 8 x G4 HOLES	<b>TK-1579LM</b> 8 x TLED-G4A	<b>TK-1579LMC</b> 8 x TLED-G4CA	<b>TK-1580</b> 20 x 3/4" HOLES	<b>TK-1580L</b> 20 x TLED-B2A	<b>TK-1580LC</b> 20 x TLED-B2CA
--	-----------	----------------	--------------------------------	----------------------------------	------------------------------------	-----------------------------------	----------------------------------	------------------------------------

Install with supplied Hardware.

 **WARNING:** Cancer and Reproductive Harm - [www.p65warnings.ca.gov](http://www.p65warnings.ca.gov)

# KENWORTH T800





- 430 Mirror Shine Stainless Steel
- LED Lighting
- 1 Year Warranty

- Hardware Included
- Sold as a Pre-Wired & Assembled Kit\*

\*Depending on Part Number

## CAB PANELS STAINLESS STEEL

	PANEL WIDTH	BLANK	G4 HOLES			3/4" HOLES		
<b>AEROCAB</b> T800 1995-2010 NO BLOCK HEATER	3.25" WIDE	<b>TK-1318</b>	<b>TK-1370</b> 6 x G4 HOLES	<b>TK-1370LM</b> 6 x TLED-G4A	<b>TK-1370LMC</b> 6 x TLED-G4CA	-	-	-

Cab Panels are 40.56" Long. Install with supplied Hardware.

<b>WITH STEP DPF</b> MX ENGINE T800 2011+ 1 BLOCK HEATER	3.25" WIDE	<b>TK-13114</b>	<b>TK-1368</b> 6 x G4 HOLES	<b>TK-1368LM</b> 6 x TLED-G4A	<b>TK-1368LMC</b> 6 x TLED-G4CA	-	-	-
---	------------	-----------------	--------------------------------	----------------------------------	------------------------------------	---	---	---

Install with supplied Hardware.



 WARNING: Cancer and Reproductive Harm - [www.p65warnings.ca.gov](http://www.p65warnings.ca.gov)

## SLEEPER PANELS WITHOUT EXTENSION

### STAINLESS STEEL

	PANEL WIDTH	BLANK	G4 HOLES			3/4" HOLES		
<b>72" SLEEPER</b> SIDE MOUNT EXHAUST T800 EPA 2007+	3.5" WIDE	<b>TK-1501</b>	<b>TK-1502</b> 8 x G4 HOLES	<b>TK-1502LM</b> 8 x TLED-G4A	<b>TK-1502LMC</b> 8 x TLED-G4CA	<b>TK-1578</b> 14 x 3/4" HOLES	<b>TK-1578L</b> 18 x TLED-B2A	<b>TK-1578LC</b> 18 x TLED-B2CA
<b>62" SLEEPER</b> SIDE MOUNT EXHAUST T800 EPA 2007+	3.5" WIDE	<b>TK-1513</b>	<b>TK-1514</b> 6 x G4 HOLES	<b>TK-1514LM</b> 6 x TLED-G4A	<b>TK-1514LMC</b> 6 x TLED-G4CA	<b>TK-1565</b> 14 x 3/4" HOLES	<b>TK-1565L</b> 14 x TLED-B2A	<b>TK-1565LC</b> 14 x TLED-B2CA

Install with supplied Hardware.

## SLEEPER PANELS WITH EXTENSION

### STAINLESS STEEL

	PANEL WIDTH	BLANK	G4 HOLES			3/4" HOLES		
<b>72" SLEEPER</b> SIDE MOUNT EXHAUST T800 EPA 2007+	3.5" WIDE	<b>TK-1503</b>	<b>TK-1504</b> 10 x G4 HOLES	<b>TK-1504LM</b> 10 x TLED-G4A	<b>TK-1504LMC</b> 10 x TLED-G4CA	-	-	-
<b>72" SLEEPER</b> SIDE MOUNT EXHAUST T800 2007+	3.5" WIDE	-	-	-	-	<b>TK-1566</b> 24 x 3/4" HOLES	<b>TK-1566L</b> 24 x TLED-B2A	<b>TK-1566LC</b> 24 x TLED-B2CA
<b>62" SLEEPER</b> SIDE MOUNT EXHAUST T800 EPA 2007+	3.5" WIDE	<b>TK-1515</b>	<b>TK-1579</b> 8 x G4 HOLES	<b>TK-1579LM</b> 8 x TLED-G4A	<b>TK-1579LMC</b> 8 x TLED-G4CA	<b>TK-1580</b> 20 x 3/4" HOLES	<b>TK-1580L</b> 20 x TLED-B2A	<b>TK-1580LC</b> 20 x TLED-B2CA

Install with supplied Hardware.



 WARNING: Cancer and Reproductive Harm - [www.p65warnings.ca.gov](http://www.p65warnings.ca.gov)

# KENWORTH TRIMS

## DOOR WINDOW SHADES ALL YEARS



STAINLESS STEEL

**TK-1401** Without Convex Mirror Cutout

**TK-1402** With Convex Mirror Arm Cutout (Passenger)

### TECHNICAL SPECIFICATIONS

#### MODELS WITH DAYLIGHT DOOR

**ALL KENWORTH MODELS** (All Years)

WHAT'S INCLUDED	Hardware & 3M Tape (Double Sided)
SOLD	As a Pair
WARRANTY	1 Year

## HEADLIGHT VISORS ALL YEARS



STAINLESS STEEL

**TK-1219** Double Headlights Only

### TECHNICAL SPECIFICATIONS

#### KENWORTH MODELS

**ALL MODELS** (All Years)

SOLD	As a Pair
WARRANTY	1 Year

Install using existing hardware.

## WINDOW CHOP TOPS ALL YEARS



STAINLESS STEEL

**TK-1430** With Flange



STAINLESS STEEL

**TK-1431** Without Flange

### TECHNICAL SPECIFICATIONS

#### KENWORTH MODELS

**ALL MODELS** (All Years)

WHAT'S INCLUDED	3M Tape (Double Sided)
SOLD	As a Pair
WARRANTY	1 Year

Install using supplied 3M Tape.

 **WARNING:** Cancer and Reproductive Harm - [www.p65warnings.ca.gov](http://www.p65warnings.ca.gov)

## FLAME HOOD EMBLEM ACCENT - ALL YEARS



STAINLESS STEEL  
**TK-1609**

### TECHNICAL SPECIFICATIONS

#### KENWORTH MODELS

**ALL MODELS** (All Years)

WHAT'S INCLUDED	3M Tape (Double Sided)
SOLD	As a Pair
WARRANTY	1 Year

Install using supplied 3M Tape.

## W900/T800/T600/T300/C500 DAYLIGHT DOOR TRIMS - ALL YEARS



STAINLESS STEEL  
**TK-1407**

### TECHNICAL SPECIFICATIONS

#### MODELS WITH DAYLIGHT DOOR

**W900, T800, T600, T300 & C500** (All Years)

WHAT'S INCLUDED	3M Tape (Double Sided)
SOLD	As a Pair
WARRANTY	1 Year

Will NOT fit T680, T880 or T2000 Models. Install using supplied 3M Tape.

## T660/T470/T440/T370/T270/T170 AIR INTAKE LOGO TRIMS



STAINLESS STEEL  
**TK-1121**

### TECHNICAL SPECIFICATIONS

#### KENWORTH MODELS

**T660, T370, T270 & T170** (2005+)  
**T470, T440** (2010+)

WHAT'S INCLUDED	3M Tape (Double Sided)
SOLD	As a Pair
WARRANTY	1 Year

Install using supplied 3M Tape.

## T660/T370 AIR INTAKE LOGO TRIMS - 2008+



STAINLESS STEEL  
**TK-1119**

### TECHNICAL SPECIFICATIONS

#### KENWORTH MODELS

**T660 & T370** (2008+)

WHAT'S INCLUDED	3M Tape (Double Sided)
SOLD	As a Pair
WARRANTY	1 Year

Install using supplied 3M Tape.

# KENWORTH TRIMS

## BATTERY / TOOLBOX COVERS WITH STEPS



▲ STAINLESS STEEL  
**TK-1616** 34" Wide



▲ STAINLESS STEEL  
**TK-1617** 39.5" Wide



▲ STAINLESS STEEL  
**TK-1618** 45" Wide

### TECHNICAL SPECIFICATIONS

#### KENWORTH MODELS

**TK-1616** (1987-2004) **TK-1617** (2005-2011)  
**TK-1618** (2005-2007)

WHAT'S INCLUDED	Hardware
SOLD	As a Kit
WARRANTY	1 Year

Replaces OEM Aluminium Covers. Install using supplied Hardware.



## 45" STEP HANGERS PRE-2005

## BATTERY / TOOLBOX COVERS PRE-2005



▲ STAINLESS STEEL  
**TK-1631** For 45" Covers



▲ STAINLESS STEEL  
**TK-1630** 39.5" Wide



▲ STAINLESS STEEL  
**TK-1634** 45" Wide

### TECHNICAL SPECIFICATIONS

#### KENWORTH MODELS

**ALL MODELS** (Pre-2005)

GAUGE	11 Gauge
WHAT'S INCLUDED	3M Tape (Double Sided)
SOLD	As a Pair
WARRANTY	1 Year

Install using supplied 3M Tape.

### TECHNICAL SPECIFICATIONS

#### KENWORTH MODELS

**ALL MODELS** (Pre-2005)

WHAT'S INCLUDED	Hardware
SOLD	As a Pair
WARRANTY	1 Year

Install using supplied Hardware.

▲ WARNING: Cancer and Reproductive Harm - [www.p65warnings.ca.gov](http://www.p65warnings.ca.gov)

## T680 FENDER TRIMS FOR MODEL WITH FAIRINGS - 2013+



STAINLESS STEEL  
**TFT-KWT680**

### TECHNICAL SPECIFICATIONS

#### MODEL WITH FAIRINGS

**T680** (2013+)

WHAT'S INCLUDED	3M Tape (Double Sided)
SOLD	As a Kit (4 Pieces)
WARRANTY	1 Year

Install using supplied 3M Tape.

## T680 FENDER TRIMS FOR MODEL WITHOUT FAIRINGS - 2013+



STAINLESS STEEL  
**TFT-KWT680N**

### TECHNICAL SPECIFICATIONS

#### MODEL WITHOUT FAIRINGS

**T680** (2013+)

WHAT'S INCLUDED	3M Tape (Double Sided)
SOLD	As a Kit (4 Pieces)
WARRANTY	1 Year

Install using supplied 3M Tape.

## T680 SIDE HOOD TRIMS LONG HOOD - ALL YEARS



STAINLESS STEEL  
**TK-1133**

### TECHNICAL SPECIFICATIONS

#### LONG HOOD MODEL

**T680** (All Years)

WHAT'S INCLUDED	3M Tape (Double Sided)
SOLD	As a Kit (4 Pieces)
WARRANTY	1 Year

Install using supplied 3M Tape.

## T680 CENTER HOOD TRIMS SHORT HOOD | LONG HOOD



STAINLESS STEEL  
**TK-1143** Long Hood SFA  
**TK-1144** Short Hood SBA

### TECHNICAL SPECIFICATIONS

#### KENWORTH MODELS

**TK-1143** T680 Long Hood Set Forward Axle (2015+)  
**TK-1144** T680 Short Hood Set Back Axle (2012+)

WHAT'S INCLUDED	3M Tape (Double Sided)
SOLD	Individually
WARRANTY	1 Year

Install using supplied 3M Tape.

# KENWORTH TRIMS

## T680 HEADLIGHT TRIMS - 2013+



STAINLESS STEEL  
**TK-1226**

### TECHNICAL SPECIFICATIONS

#### KENWORTH MODEL

**T680** (2013+)

WHAT'S INCLUDED	Hardware & 3M Tape (Double Sided)
SOLD	As a Pair
WARRANTY	1 Year

Drilling of fender is required. Install using supplied Hardware & 3M Tape.

## T680 UPPER SLEEPER WINDOW TRIMS - 2016+



STAINLESS STEEL  
**TK-1451** "T680" Cutout

### TECHNICAL SPECIFICATIONS

#### HIGH ROOF MODELS

**T680** (2016+)

WHAT'S INCLUDED	Hardware & 3M Tape (Double Sided)
SOLD	As a Pair
WARRANTY	1 Year

Install using supplied Hardware & 3M Tape.

## T680 SLEEPER WINDOW TRIMS - 2013+



STAINLESS STEEL  
**TK-1651**

### TECHNICAL SPECIFICATIONS

#### KENWORTH MODEL

**T680** (2013+)

WHAT'S INCLUDED	Hardware & 3M Tape (Double Sided)
SOLD	As a Pair
WARRANTY	1 Year

Install using supplied Hardware & 3M Tape.

## T680 FRONT LOWER STEP KICK PLATES - PRE-2017



STAINLESS STEEL  
**TK-1670**

### TECHNICAL SPECIFICATIONS

#### LONG HOOD MODEL

**T680** (Pre-2017)

WHAT'S INCLUDED	Hardware
SOLD	As a Pair
WARRANTY	1 Year

Install using supplied Hardware.

## T680 FRONT LOWER STEP KICK PLATES - PRE-2017



STAINLESS STEEL  
**TK-1671**

### TECHNICAL SPECIFICATIONS

#### SHORT HOOD MODEL

**T680** (Pre-2017)

WHAT'S INCLUDED	Hardware
SOLD	As a Pair
WARRANTY	1 Year

Install using supplied Hardware.

## T680 FRONT UPPER STEP KICK PLATES - ALL YEARS



STAINLESS STEEL  
**TK-1672**

### TECHNICAL SPECIFICATIONS

#### KENWORTH MODEL

**T680** (All Years)

WHAT'S INCLUDED	Hardware & 3M Tape (Double Sided)
SOLD	As a Pair
WARRANTY	1 Year

Install using supplied Hardware & 3M Tape.

**WARNING:** Cancer and Reproductive Harm - [www.p65warnings.ca.gov](http://www.p65warnings.ca.gov)



**T680 DOUBLE LICENSE PLATE HOLDER - 2013+**



STAINLESS STEEL  
**TK-1712**

**TECHNICAL SPECIFICATIONS**

**SHORT HOOD MODEL**

**T680** (2013+)

WHAT'S INCLUDED	Hardware & Brackets
SOLD	Individually
WARRANTY	1 Year

Install using supplied Hardware & brackets.

**T680/T880 DOOR WINDOW SHADES - 2012+**



STAINLESS STEEL  
**TK-1438**

**TECHNICAL SPECIFICATIONS**

**LONG HOOD MODELS**

**T680 & T880** (2012+)

WHAT'S INCLUDED	Hardware & 3M Tape (Double Sided)
SOLD	As a Pair
WARRANTY	1 Year

Install using supplied Hardware & 3M Tape.

**T680/T880 DOOR WINDOW SHADES - ALL YEARS**



STAINLESS STEEL  
**TP-1440**

**TECHNICAL SPECIFICATIONS**

**KENWORTH MODELS**

**T680 & T880** (All Years)

WHAT'S INCLUDED	Hardware & 3M Tape (Double Sided)
SOLD	As a Pair
WARRANTY	1 Year

Designed for models with or without passenger side mirror. Install using supplied Hardware & 3M Tape.

**T680/T880 DOOR HANDLE TRIMS - 2013+**



STAINLESS STEEL  
**TK-1427**

**TECHNICAL SPECIFICATIONS**

**KENWORTH MODELS**

**T680 & T880** (2013+)

WHAT'S INCLUDED	Hardware & 3M Tape (Double Sided)
SOLD	As a Pair
WARRANTY	1 Year

Install using supplied Hardware & 3M Tape.

**T680 DEF TANK INNER/OUTER TRIM - ALL YEARS**



STAINLESS STEEL  
**TK-1680** Inner Trim  
**TK-1681** Outer Trim

**TECHNICAL SPECIFICATIONS**

**SHORT HOOD MODELS**

**T680** (All Years)

WHAT'S INCLUDED	3M Tape (Double Sided)
SOLD	Individually
WARRANTY	1 Year

Install using supplied 3M Tape.

**T680/T880 FENDER LIGHT TRIMS - 2013+**



STAINLESS STEEL  
**TK-1428**

**TECHNICAL SPECIFICATIONS**

**KENWORTH MODELS**

**T680 & T880** (2013+)

WHAT'S INCLUDED	3M Tape (Double Sided)
SOLD	As a Pair
WARRANTY	1 Year

Install using supplied 3M Tape.

# KENWORTH TRIMS

## T660 UPPER PANEL KICK PLATES

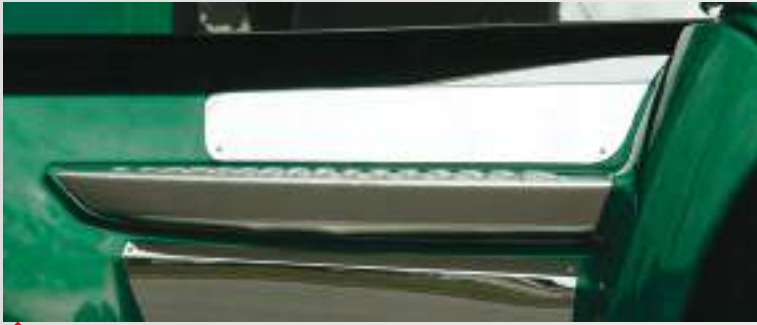

STAINLESS STEEL  
**TK-1602** Pre-2010  
**TK-1649** 2011+

### TECHNICAL SPECIFICATIONS

#### KENWORTH MODELS

**TK-1602:** T660 (Pre-2010) **TK-1649:** T660 (2011+)

WHAT'S INCLUDED	Hardware
SOLD	As a Pair
WARRANTY	1 Year

Install using supplied Hardware.

## T660 LOWER PANEL FRONT KICK PLATES - 2007+



STAINLESS STEEL  
**TK-1603**

### TECHNICAL SPECIFICATIONS

#### KENWORTH MODEL

**T660** (2007+)

WHAT'S INCLUDED	Hardware
SOLD	As a Pair
WARRANTY	1 Year

Install using supplied Hardware.

## T680/T660/T700 UPPER PANEL BACK STEP TRIMS - 2007-2016



STAINLESS STEEL  
**TK-1620**

### TECHNICAL SPECIFICATIONS

#### KENWORTH MODELS

**T680, T660 & T700** (2007-2016)

WHAT'S INCLUDED	Hardware & 3M Tape (Double Sided)
SOLD	As a Pair
WARRANTY	1 Year

Install using supplied Hardware & 3M Tape.

## T680/T660/T700 LOWER PANEL PANEL BACK STEP TRIMS - 2007-2016



STAINLESS STEEL  
**TK-1621**

### TECHNICAL SPECIFICATIONS

#### KENWORTH MODELS

**T680, T660 & T700** (2007-2016)

WHAT'S INCLUDED	Hardware & 3M Tape (Double Sided)
SOLD	As a Pair
WARRANTY	1 Year

Install using supplied Hardware & 3M Tape.

 WARNING: Cancer and Reproductive Harm - [www.p65warnings.ca.gov](http://www.p65warnings.ca.gov)

## T660 FRONT FENDER HEADLIGHT TRIMS - 2006-2017



STAINLESS STEEL  
**TK-1211**

### TECHNICAL SPECIFICATIONS

#### KENWORTH MODEL

**T660** (2006-2017)

WHAT'S INCLUDED	3M Tape (Double Sided)
SOLD	As a Pair
WARRANTY	1 Year

Install using supplied 3M Tape.

## T660 FENDER TRIMS 2006-2017



STAINLESS STEEL  
**TFT-KWT660**

### TECHNICAL SPECIFICATIONS

#### KENWORTH MODEL

**T660** (2006-2017)

WHAT'S INCLUDED	3M Tape (Double Sided)
SOLD	As a Kit
WARRANTY	1 Year

Install using supplied 3M Tape.

## T660 LICENSE PLATE HOLDER - ALL YEARS



STAINLESS STEEL  
**TK-1704** Holds 2 Plates

### TECHNICAL SPECIFICATIONS

#### KENWORTH MODEL

**T660** (All Years)

WHAT'S INCLUDED	Hardware, Brackets & License Plate Bezels
SOLD	Individually
WARRANTY	1 Year

Install using supplied Hardware.

## T660/W900L/B UPPER SLEEPER FORWARD FACING WINDOW TRIMS - ALL YEARS



STAINLESS STEEL  
**TK-1436**

### TECHNICAL SPECIFICATIONS

#### AEROCAB AERODYNE SLEEPER MODELS

**T660, W900L & W900B** (All Years)

WHAT'S INCLUDED	3M Tape (Double Sided)
SOLD	As a Pair
WARRANTY	1 Year

Install using supplied 3M Tape.

# KENWORTH TRIMS

## W900L LOUVERED STRAIGHT GRILLE BARS - ALL YEARS



STAINLESS STEEL  
**TK-1002** 16 Straight Bars

### TECHNICAL SPECIFICATIONS

#### KENWORTH MODEL

**W900L** (All Years)

WHAT'S INCLUDED	Hardware
SOLD	As a Kit (16 Bars)
WARRANTY	1 Year

Not Suitable for W900B Models. Install using supplied Hardware.

## W900L LOUVERED ANGLED GRILLE BARS - ALL YEARS



STAINLESS STEEL  
**TK-1003** 16 Angled Bars

### TECHNICAL SPECIFICATIONS

#### KENWORTH MODEL

**W900L** (All Years)

WHAT'S INCLUDED	Hardware
SOLD	As a Kit (16 Bars)
WARRANTY	1 Year

Not Suitable for W900B Models. Install using supplied Hardware.

## W900B/L SIDE GRILLE DEFLECTORS - 1967+



STAINLESS STEEL  
**TK-1105**

### TECHNICAL SPECIFICATIONS

#### KENWORTH MODELS

**W900L & W900B** (1967+)

SOLD	As a Pair
WARRANTY	1 Year

Install to the side of the Grille with OEM Hardware.

## W900L HOOD STRIP - PRE-2008



STAINLESS STEEL  
**TK-1111**

### TECHNICAL SPECIFICATIONS

#### KENWORTH MODEL

**W900L** (Pre-2008)

WHAT'S INCLUDED	Hardware & 3M Tape (Double Sided)
SOLD	Individually
WARRANTY	1 Year

Will NOT fit W900L Metton Hood Models. Install using supplied Hardware & 3M Tape.

## W900 SWING LICENSE PLATE - ALL YEARS



STAINLESS STEEL  
**TK-1702** Holds 2 Plates

### TECHNICAL SPECIFICATIONS

#### TEXAS STYLE BUMPER MODEL

**W900B** (All Years)

WHAT'S INCLUDED	Hardware & License Plate Bezels
SOLD	Individually
WARRANTY	1 Year

No drilling is required, Install onto existing Bumper Mounting Bolt Pattern. Install using supplied Hardware.

**WARNING:** Cancer and Reproductive Harm - [www.p65warnings.ca.gov](http://www.p65warnings.ca.gov)

## W900B/L FENDER HEADLIGHT GUARDS



STAINLESS STEEL  
**TK-1203** W900L Models  
**TK-1204** W900B Aerocab Models

### TECHNICAL SPECIFICATIONS

KENWORTH MODELS	
<b>TK-1203:</b>	W900L (1989+)
<b>TK-1204:</b>	W900B Aerocab Curved Glass (1989-2009)

WHAT'S INCLUDED	Hardware
SOLD	As a Pair
WARRANTY	1 Year

## W900B/L HEADLIGHT SURROUND FENDER GUARDS



STAINLESS STEEL  
**TK-1201** W900L Models



STAINLESS STEEL  
**TK-1202** W900B Models

### TECHNICAL SPECIFICATIONS

KENWORTH MODELS	
<b>TK-1201:</b>	W900L (All Years)
<b>TK-1202:</b>	W900B (1989-2009)

WHAT'S INCLUDED	Hardware
SOLD	As a Pair
WARRANTY	1 Year

Drilling is required. Install using supplied Hardware.

## W900L AIR INTAKE SHROUDS - 2008+



STAINLESS STEEL  
**TK-1110**

### TECHNICAL SPECIFICATIONS

MODEL WITH METTON HOOD	
<b>W900L</b> (2008+)	

WHAT'S INCLUDED	Hardware
SOLD	As a Pair
WARRANTY	1 Year

Drilling into the Hood is required. Install using supplied Hardware.

## W900L FRONT FENDER MUD FLAP BRACKETS



STAINLESS STEEL  
**TK-1901** Reinforcement Bracket

### TECHNICAL SPECIFICATIONS

KENWORTH MODEL	
<b>W900L</b> (All Years)	

SOLD	As a Pair
WARRANTY	1 Year

Install using existing hardware.

# KENWORTH TRIMS

## W900L HOOD/BATTERY BOX FILLER PANELS - 1997-2010



STAINLESS STEEL  
**TK-1114**



STAINLESS STEEL  
**TK-1113** 8 x Slotted Holes

### TECHNICAL SPECIFICATIONS

#### KENWORTH MODEL

**W900L** (1997-2010)

WHAT'S INCLUDED	Hardware, Brackets & *OEM Plug (*TK-1113 Only)
SOLD	As a Pair
WARRANTY	1 Year

Replacement for the OEM Hood/Battery Box Filler Panel. Install using supplied Hardware & Brackets.

## W900/T800/T440 VIEW DOOR WINDOW TRIM

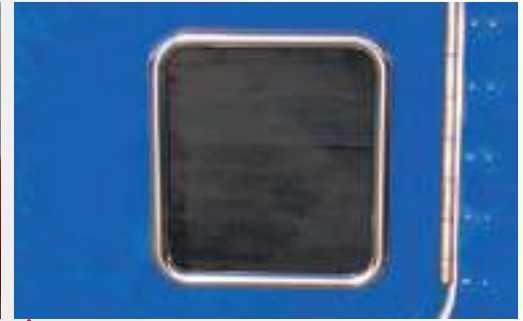

STAINLESS STEEL  
**TK-1409** Passenger Side

### TECHNICAL SPECIFICATIONS

#### KENWORTH MODELS

**W900, T800 & T440** (All Years)

WHAT'S INCLUDED	Silicone
SOLD	Individually
WARRANTY	1 Year

Install using supplied Silicone.

## W900/T800 AIR INTAKE SHROUDS - 1982+



STAINLESS STEEL  
**TK-1107**

### TECHNICAL SPECIFICATIONS

#### KENWORTH MODELS

**W900 & T800** (1982+)

WHAT'S INCLUDED	Hardware
SOLD	As a Pair
WARRANTY	1 Year

Drilling into the Hood is required. Install using supplied Hardware.

## W900B/L/T800 FUEL TANK SKIRT FAIRINGS - 2013+



STAINLESS STEEL  
**TK-1419**

### TECHNICAL SPECIFICATIONS

#### KENWORTH MODELS

**W900B, W900L & T800** (2013+)

DIMENSIONS	73" Long
SOLD	As a Pair
WARRANTY	1 Year

Install using existing Hardware.

**WARNING:** Cancer and Reproductive Harm - [www.p65warnings.ca.gov](http://www.p65warnings.ca.gov)

## T800 SIDE GRILLE DEFLECTOR - ALL YEARS



STAINLESS STEEL  
**TK-1115**

**TECHNICAL SPECIFICATIONS**

**KENWORTH MODELS**  
T800 (All Years)

SOLD	Individually
WARRANTY	1 Year

Install using existing hardware.

## T800 GRILLE SURROUND KIT - 1995+



STAINLESS STEEL  
**TK-1140** 11 Straight Bars

**TECHNICAL SPECIFICATIONS**

**KENWORTH MODELS**  
T800 (1995+)

SOLD	As a Kit (11 Bars)
WARRANTY	1 Year

Install using existing Hardware.

## T800 HEADLIGHT SURROUND FENDER GUARDS



STAINLESS STEEL  
**TK-1224**

**TECHNICAL SPECIFICATIONS**

**FLAT GLASS STANDARD CAB MODELS**  
T800 (All Years)

WHAT'S INCLUDED	Hardware
SOLD	As a Pair
WARRANTY	1 Year

Drilling is required. Install with supplied Hardware.

## T800 UNDER HEADLIGHT FENDER GUARDS



STAINLESS STEEL  
**TK-1225**

**TECHNICAL SPECIFICATIONS**

**STANDARD CAB MODELS**  
T800 (1987-1995)

WHAT'S INCLUDED	Hardware
SOLD	As a Pair
WARRANTY	1 Year

Drilling is required. Install using supplied Hardware.

## T800 FENDER GUARDS STANDARD | AEROCAB CURVED GLASS



STAINLESS STEEL  
**TK-1205** Standard

**TECHNICAL SPECIFICATIONS**

**KENWORTH MODELS**  
TK-1205: T800 (Pre-2008)  
TK-1206: T800 Aerocab Curved Glass (2007+)

WHAT'S INCLUDED	Hardware
SOLD	As a Pair
WARRANTY	1 Year

Drilling is required. Install using supplied Hardware.



STAINLESS STEEL  
**TK-1206** Aerocab Curved Glass

# KENWORTH TRIMS

## T800 AIR INTAKE SHROUDS AEROCAB HOOD | FIBERGLASS HOOD | METTON HOOD



STAINLESS STEEL  
**TK-1208** Aerocab Hood



STAINLESS STEEL  
**TK-1209** Fiberglass Hood



STAINLESS STEEL  
**TK-1210** Metton Hood

### TECHNICAL SPECIFICATIONS

#### SPLIT FENDER MODELS

**TK-1208:** T800 Aerocab Hood (Pre-2008)

**TK-1209:** T800 Fiberglass Hood (Pre-2008)

**TK-1210:** T800 Metton Hood (2008+)

WHAT'S INCLUDED	Hardware
SOLD	As a Pair
WARRANTY	1 Year

Install using the supplied Hardware. Drilling is required. NOT for wide hood models.

### T800/T600 AIR INTAKE COVERS - ALL YEARS



STAINLESS STEEL  
**TK-1600** Driver Side  
**TK-1601** Passenger Side

### TECHNICAL SPECIFICATIONS

#### STANDARD CAB MODELS

**T800 & T600** (All Years)

WHAT'S INCLUDED	Hardware
SOLD	Individually
WARRANTY	1 Year

Drilling is required. Install using supplied hardware.

### T600 HEADLIGHT FENDER GUARDS - ALL YEARS



STAINLESS STEEL  
**TK-1214**

### TECHNICAL SPECIFICATIONS

#### KENWORTH MODEL

**T600** (All Years)

WHAT'S INCLUDED	Hardware
SOLD	As a Pair
WARRANTY	1 Year

Drilling is required. Install using supplied hardware.

### T600 GRILLE BEZEL - ALL YEARS



STAINLESS STEEL  
**TK-0108**

### TECHNICAL SPECIFICATIONS

#### KENWORTH MODEL

**T600** (All Years)

WHAT'S INCLUDED	Hardware
SOLD	Individually
WARRANTY	1 Year

Drilling & Bolting is required. Install using supplied hardware.

**WARNING:** Cancer and Reproductive Harm - [www.p65warnings.ca.gov](http://www.p65warnings.ca.gov)



## T600 DOOR KICK PLATES - ALL YEARS



STAINLESS STEEL  
**TK-1406** Block Heater Hole

### TECHNICAL SPECIFICATIONS

#### KENWORTH MODEL

**T600** (All Years)

SOLD	As a Pair
WARRANTY	1 Year

Driver Side Block Heater Hole. Install using existing factory mounting holes.

## T880 AIR INTAKE GRILLE TRIMS - 2013+



STAINLESS STEEL  
**TK-1141**

### TECHNICAL SPECIFICATIONS

#### KENWORTH MODEL

**T880** (2013+)

WHAT'S INCLUDED	Hardware Kit
SOLD	As a Kit
WARRANTY	1 Year

Drilling of mounting holes through hood is required. Install using supplied Hardware.

## T880 SIDE GRILLE DEFLECTORS - 2012+



STAINLESS STEEL  
**TK-1134**

### TECHNICAL SPECIFICATIONS

#### KENWORTH MODEL

**T880** (2012+)

SOLD	As a Pair
WARRANTY	1 Year

Install using existing hardware.

## T880 FRONT FENDER GUARDS HEADLIGHT GUARDS | SIDE GUARDS - 2012+



STAINLESS STEEL  
**TK-1229** Front Headlight Guards

### TECHNICAL SPECIFICATIONS

#### KENWORTH MODEL

**T880** (2012+)

WHAT'S INCLUDED	Hardware
SOLD	As a Pair
WARRANTY	1 Year

Install using supplied 3M Tape.



STAINLESS STEEL  
**TK-1232** Front Side Guards

## T880 FRONT LIGHT TRIMS - 2012+



STAINLESS STEEL  
**TK-1228**

### TECHNICAL SPECIFICATIONS

#### KENWORTH MODEL

**T880** (2012+)

WHAT'S INCLUDED	3M Tape (Double Side)
SOLD	As a Pair
WARRANTY	1 Year

Install using supplied 3M Tape.

# FREIGHTLINER SUN VISORS

## 18" CASCADIA SUN VISOR - 2008-2013



STAINLESS STEEL  
**TSUN-F70** Blank  
**TSUN-F71** 10 x 3/4" Holes

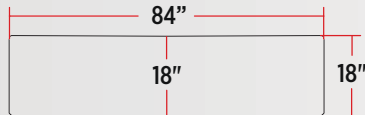

### TECHNICAL SPECIFICATIONS

#### FREIGHTLINER MODEL

**CASCADIA** (2008-2013)

DIMENSIONS	Width: 84"   Sides: 18"   Drop: 18"
WHAT'S INCLUDED	4 x Sun Visor Brackets & All Hardware
WARRANTY	1 Year

Visit our website at [www.truxaccessories.com](http://www.truxaccessories.com) for Installation Instructions. Drilling may be required.

## 16" DAYCAB SUN VISOR CASCADIA- 2008-2014



STAINLESS STEEL  
**TSUN-F26** Blank  
**TSUN-F37** 22 x 3/4" Holes

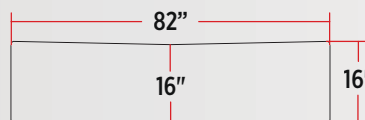

### TECHNICAL SPECIFICATIONS

#### DAY CAB MODELS

**CASCADIA** (2008-2014)

DIMENSIONS	Width: 82"   Sides: 16"   Drop: 16"
WHAT'S INCLUDED	5 x Sun Visor Brackets, OEM Light Holes & All Hardware
WARRANTY	1 Year

TSUN-F26 & TSUN-F37 are designed with OEM light holes. For installation instructions visit our website.

## 14" DAYCAB SUN VISOR - 2001+



STAINLESS STEEL  
**TSUN-F24**

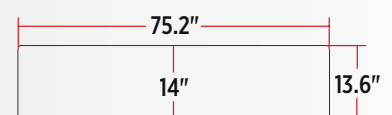

### TECHNICAL SPECIFICATIONS

#### DAYCAB MODELS

**CENTURY CLASS, COLUMBIA & CORONADO** (2001+)

DIMENSIONS	Width: 75.2"   Sides: 13.6"   Drop: 14"
WHAT'S INCLUDED	3 x Sun Visor Brackets & All Hardware
WARRANTY	1 Year

Visit our website at [www.truxaccessories.com](http://www.truxaccessories.com) for Installation Instructions. Drilling may be required.

## 16" RAISED & MID ROOF SUN VISOR - CASCADIA



STAINLESS STEEL  
**TSUN-F25** 2008-2013  
**TSUN-F32** 2014+

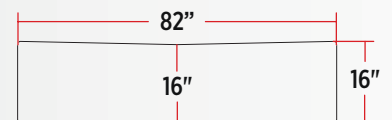

### TECHNICAL SPECIFICATIONS

#### NON DAY CAB MODELS

**TSUN-F25:** CASCADIA (2008-2013) **TSUN-F32:** CASCADIA (2014+)

DIMENSIONS	Width: 82"   Sides: 16"   Drop: 16"
WHAT'S INCLUDED	5 x Sun Visor Brackets, OEM Light Holes & All Hardware
WARRANTY	1 Year

TSUN-F25 & TSUN-F32 are designed with OEM light holes and will not fit Daycab models. For installation instructions visit our website.

**WARNING:** Cancer and Reproductive Harm - [www.p65warnings.ca.gov](http://www.p65warnings.ca.gov)

## 16" RAISED & MID ROOF SUN VISOR



▲  
STAINLESS STEEL  
**TSUN-F21** Blank

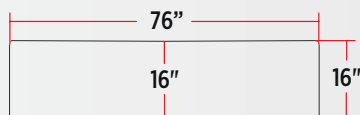

### TECHNICAL SPECIFICATIONS

#### FREIGHTLINER MODELS

**CORONADO** (2001+)  
**CENTURY CLASS & COLUMBIA** (Pre- 2005)

DIMENSIONS	Width: 76"   Sides: 16"   Drop: 16"
WHAT'S INCLUDED	3 x Sun Visor Brackets & All Hardware
WARRANTY	1 Year

Remove original factory brackets and install using TRUX brackets. For installation instructions visit our website.

## 16" RAISED & MID ROOF SUN VISOR - 2005+



▲  
STAINLESS STEEL  
**TSUN-F17** Blank  
**TSUN-F19** 5 x Slotted Holes

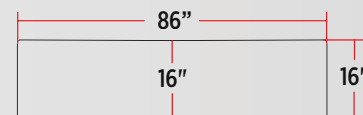

### TECHNICAL SPECIFICATIONS

#### FREIGHTLINER MODELS

**CENTURY CLASS & COLUMBIA** (2005+)

DIMENSIONS	Width: 86"   Sides: 16"   Drop: 16"
WHAT'S INCLUDED	3 x Sun Visor Brackets & All Hardware
WARRANTY	1 Year

Remove original factory brackets and install using TRUX brackets. For installation instructions visit our website.

## 16" RAISED ROOF SUN VISOR - 1991+



▲  
STAINLESS STEEL  
**TSUN-F6**

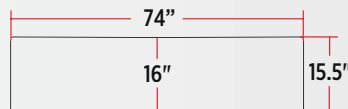

### TECHNICAL SPECIFICATIONS

#### FREIGHTLINER MODELS

**CLASSIC, CLASSIC XL, FLD112 & FLD120** (1991+)

DIMENSIONS	Width: 74"   Sides: 15.5"   Drop: 16"
WHAT'S INCLUDED	5 x Sun Visor Brackets & All Hardware
WARRANTY	1 Year

Remove original factory brackets and install using TRUX Brackets. For installation instructions visit our website.

## 16" RAISED ROOF SUN VISOR - 1991+



▲  
STAINLESS STEEL  
**TSUN-F8** 6 x Slotted Holes

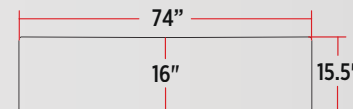

### TECHNICAL SPECIFICATIONS

#### FREIGHTLINER MODELS

**CLASSIC, CLASSIC XL, FLD120 & FLD112** (1991+)

DIMENSIONS	Width: 74"   Sides: 15.5"   Drop: 16"
WHAT'S INCLUDED	5 x Sun Visor Brackets & All Hardware
WARRANTY	1 Year

Remove original factory brackets and install using TRUX brackets. For installation instructions visit our website.

# FREIGHTLINER SUN VISORS

## 15" OEM METAL FLAT TOP SUN VISOR - 1991+



▲  
STAINLESS STEEL  
**TSUN-F1**

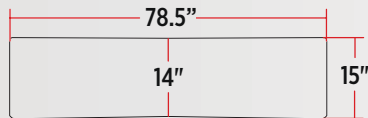

### TECHNICAL SPECIFICATIONS

#### MODELS WITH CAB MOUNTED MIRRORS

**CLASSIC, CLASSIC XL, FLD120 & FLD112 (1991+)**

DIMENSIONS	Width: 78.5"   Sides: 15"   Drop: 14"
WHAT'S INCLUDED	5 x Sun Visor Brackets & All Hardware
WARRANTY	1 Year

Remove original factory brackets and install using TRUX brackets. For installation instructions visit our website.

## 15" OEM METAL FLAT TOP SUN VISOR - 1991+



▲  
STAINLESS STEEL  
**TSUN-F2**

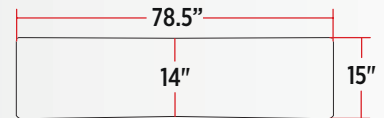

### TECHNICAL SPECIFICATIONS

#### MODELS WITH DOOR MOUNTED MIRRORS

**CLASSIC, CLASSIC XL, FLD112 & FLD120 (1991+)**

DIMENSIONS	Width: 78.5"   Sides: 15"   Drop: 14"
WHAT'S INCLUDED	5 x Sun Visor Brackets & All Hardware
WARRANTY	1 Year

Remove original factory brackets and install using TRUX brackets. For installation instructions visit our website.

## 15" OEM FIBERGLASS FLAT TOP SUN VISOR - 1991+



▲  
STAINLESS STEEL  
**TSUN-F3**

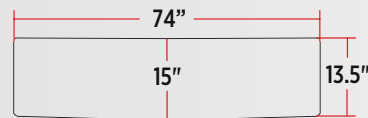

### TECHNICAL SPECIFICATIONS

#### MODELS WITH CAB MOUNTED MIRRORS

**CLASSIC, CLASSIC XL, FLD120 & FLD112 (1991+)**

DIMENSIONS	Width: 74"   Sides: 13.5"   Drop: 15"
WHAT'S INCLUDED	5 x Sun Visor Brackets & All Hardware
WARRANTY	1 Year

Remove original factory brackets and install using TRUX brackets. For installation instructions visit our website.

## 15" OEM FIBERGLASS FLAT TOP SUN VISOR - 1991+



▲  
STAINLESS STEEL  
**TSUN-F4**

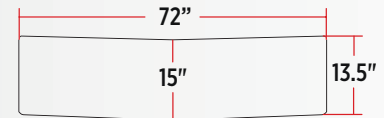

### TECHNICAL SPECIFICATIONS

#### MODELS WITH DOOR MOUNTED MIRRORS

**CLASSIC, CLASSIC XL, FLD120 & FLD112 (1991+)**

DIMENSIONS	Width: 72"   Sides: 13.5"   Drop: 15"
WHAT'S INCLUDED	5 x Sun Visor Brackets & All Hardware
WARRANTY	1 Year

Remove original factory brackets and install using TRUX brackets. For installation instructions visit our website.

▲ **WARNING:** Cancer and Reproductive Harm - [www.p65warnings.ca.gov](http://www.p65warnings.ca.gov)

## 12.25" FLAT TOP SUN VISOR - 2003-2006



STAINLESS STEEL  
**TSUN-F27**

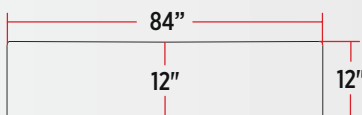

### TECHNICAL SPECIFICATIONS

#### FREIGHTLINER MODELS

**BUSINESS CLASS M2-106 & M2-112** (2003-2006)

DIMENSIONS	Width: 84"   Sides: 12"   Drop: 12"
WHAT'S INCLUDED	4 x Sun Visor Brackets & All Hardware
WARRANTY	1 Year

Remove original factory brackets and install using TRUX brackets. For installation instructions visit our website.

## 13.5" FLAT TOP SUN VISOR



STAINLESS STEEL  
**TSUN-F28**

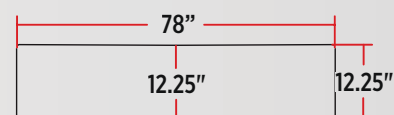

### TECHNICAL SPECIFICATIONS

#### FREIGHTLINER MODELS

**BUSINESS CLASS M2-106 & M2-112** Regular Cab (2006+)  
**BUSINESS CLASS 108SD-114SD** (2012+)

DIMENSIONS	Width: 78"   Sides: 12.25"   Drop: 12.25"
WHAT'S INCLUDED	5 x Sun Visor Brackets & All Hardware
WARRANTY	1 Year

Remove original factory brackets and install using TRUX brackets. For installation instructions visit our website.

**CAN'T FIND WHAT YOU'RE LOOKING FOR?**  
WITH OVER 2000 MORE PRODUCTS ON OUR WEBSITE, YOU'D  
BE SURE TO FIND WHAT YOU WANT!



**VISIT OUR WEBSITE**  
**TRUXACCESSORIES.COM**

# FREIGHTLINER BUG DEFLECTORS

## CASCADIA BUG DEFLECTOR HOOD SHIELD



STAINLESS STEEL  
**THOD-FLCAS** 2008-2017  
**THOD-FLCAS2** 2018+

### TECHNICAL SPECIFICATIONS

#### FREIGHTLINER MODEL

**THOD-FLCAS:** CASCADIA (2008-2017)  
**THOD-FLCAS2:** CASCADIA (2018+)

DIMENSIONS	Width: 60"
WHAT'S INCLUDED	Hardware
WARRANTY	1 Year

Drilling of mounting holes through the hood is required.

## COLUMBIA BUG DEFLECTOR HOOD SHIELD - 2001+



STAINLESS STEEL  
**THOD-FLCOL**

### TECHNICAL SPECIFICATIONS

#### FREIGHTLINER MODEL

**COLUMBIA** (2001+)

DIMENSIONS	Width: 52"
WHAT'S INCLUDED	Hardware
WARRANTY	1 Year

Drilling of mounting holes through the hood is required.

## CENTURY BUG DEFLECTOR HOOD SHIELD - 1996+



STAINLESS STEEL  
**THOD-FLCC**

### TECHNICAL SPECIFICATIONS

#### FREIGHTLINER MODELS

**CENTURY CLASS** (1996+)

DIMENSIONS	Width: 59"
WHAT'S INCLUDED	Hardware
WARRANTY	1 Year

Drilling of mounting holes through the hood is required.

## CENTURY BUG DEFLECTOR HOOD SHIELD - 2005+



STAINLESS STEEL  
**THOD-FLCC2**

### TECHNICAL SPECIFICATIONS

#### FREIGHTLINER MODEL

**CENTURY CLASS** (2005+)

DIMENSIONS	Width: 49.3"
WHAT'S INCLUDED	Hardware
WARRANTY	1 Year

Designed with a built in grab handle for hood tilting. Drilling of mounting holes through the Fiberglass hood is required.

 **WARNING:** Cancer and Reproductive Harm - [www.p65warnings.ca.gov](http://www.p65warnings.ca.gov)

## CORONADO BUG DEFLECTOR HOOD SHIELD - 2003-2010



STAINLESS STEEL  
**THOD-FLCOR**

### TECHNICAL SPECIFICATIONS

#### FREIGHTLINER MODEL

**CORONADO** (2003-2010)

DIMENSIONS	Width: 56"
WHAT'S INCLUDED	All Hardware
WARRANTY	1 Year

Drilling of mounting holes through the hood is required.

## CORONADO BUG DEFLECTOR HOOD SHIELD - 2010+



STAINLESS STEEL  
**THOD-FLCOR2**

### TECHNICAL SPECIFICATIONS

#### FREIGHTLINER MODEL

**CORONADO** (2010+)

DIMENSIONS	Width: 54.3"
WHAT'S INCLUDED	Hardware
WARRANTY	1 Year

Drilling of mounting holes through the hood is required.

## CLASSIC BUG DEFLECTOR HOOD SHIELD - 1991+



STAINLESS STEEL  
**THOD-FLCL**

### TECHNICAL SPECIFICATIONS

#### FREIGHTLINER MODEL

**CLASSIC** (1991+)

DIMENSIONS	Width: 52"
WHAT'S INCLUDED	All Hardware
WARRANTY	1 Year

Drilling of mounting holes through the hood is required.

## FLD120 BUG DEFLECTOR HOOD SHIELD - 1991+



STAINLESS STEEL  
**THOD-FLD120**

### TECHNICAL SPECIFICATIONS

#### FREIGHTLINER MODEL

**FLD120** (1991+)

DIMENSIONS	Width: 46"
WHAT'S INCLUDED	All Hardware
WARRANTY	1 Year

Drilling of mounting holes through the hood is required.

# FREIGHTLINER CASCADIA







- 430 Mirror Shine Stainless Steel
- LED Lighting
- 1 Year Warranty

- Hardware Included
- Sold as a Pre-Wired & Assembled Kit\*

\*Depending on Part Number

## CAB, SLEEPER & EXTENSION KITS STAINLESS STEEL

	PANEL WIDTH	BLANK	G4 HOLES			3/4" HOLES		
<b>72" SLEEPER STANDARD</b> 2008 NO BLOCK HEATER	3" WIDE	<b>TF-1019</b>	<b>TF-1020</b> 16 x G4 HOLES	<b>TF-1020LM</b> 16 x TLED-G4A	<b>TF-1020LMC</b> 16 x TLED-G4CA	-	-	-
<b>60" SLEEPER STANDARD</b> 2008 NO BLOCK HEATER	3" WIDE	<b>TF-1024</b>	<b>TF-1025</b> 14 x G4 HOLES	<b>TF-1025LM</b> 14 x TLED-G4A	<b>TF-1025LMC</b> 14 x TLED-G4CA	-	-	-
<b>72" SLEEPER EVOLUTION</b> ALL YEARS 1 BLOCK HEATER	3" WIDE	<b>TF-1017</b>	<b>TF-1018</b> 16 x G4 HOLES	<b>TF-1018LM</b> 16 x TLED-G4A	<b>TF-1018LMC</b> 16 x TLED-G4CA	-	-	-
<b>60" SLEEPER EVOLUTION</b> ALL YEARS 1 BLOCK HEATER	3" WIDE	<b>TF-1015</b>	<b>TF-1016</b> 14 x G4 HOLES	<b>TF-1016LM</b> 14 x TLED-G4A	<b>TF-1016LMC</b> 14 x TLED-G4CA	-	-	-

Install using supplied Hardware.

 **WARNING:** Cancer and Reproductive Harm - [www.p65warnings.ca.gov](http://www.p65warnings.ca.gov)



## 5" WINDOW CHOP TOPS 2003-2010



STAINLESS STEEL  
**TF-1429**



STAINLESS STEEL  
**TF-1430** Flange

## WIPER ARM COVERS - 2000+



STAINLESS STEEL  
**TF-1010**

### TECHNICAL SPECIFICATIONS

#### FREIGHTLINER MODELS

**COLUMBIA, CENTURY CLASS & CORONADO** (2003-2010)

WHAT'S INCLUDED	3M Tape (Double Sided)
SOLD	As a Pair
WARRANTY	1 Year

Install using supplied 3M Tape.

### TECHNICAL SPECIFICATIONS

#### FREIGHTLINER MODELS

**COLUMBIA, CENTURY CLASS  
& CORONADO** (2000+)

WHAT'S INCLUDED	3M Tape (Double Sided)
SOLD	As a Pair
WARRANTY	1 Year

Install using supplied 3M Tape.

## WIPER ARM COVERS 2004+



STAINLESS STEEL  
**TF-1011**

### TECHNICAL SPECIFICATIONS

#### FREIGHTLINER MODELS

**CLASSIC & FLD-120** (2004+)

WHAT'S INCLUDED	3M Tape (Double Sided)
SOLD	As a Pair
WARRANTY	1 Year

Install using supplied 3M Tape.

## DOOR WINDOW DEFLECTOR PRE-2010



STAINLESS STEEL  
**TF-1405**

### TECHNICAL SPECIFICATIONS

#### FREIGHTLINER MODELS

**COLUMBIA, CENTURY CLASS & CORONADO** (Pre-2010)

WHAT'S INCLUDED	3M Tape (Double Sided)
SOLD	As a Pair
WARRANTY	1 Year

Drilling of mounting holes through the hood is required. Install using supplied 3M Tape.

# FREIGHTLINER TRIMS

## CASCADIA FENDER SIDE TRIMS



STAINLESS STEEL  
**TFT-FLCAS** 2008-2017  
**TFT-FLCAS3** 2018+

### TECHNICAL SPECIFICATIONS

#### FREIGHTLINER MODEL

**TFT-FLCAS:** CASCADIA (2008-2017)  
**TFT-FLCAS3:** CASCADIA (2018+)

WHAT'S INCLUDED	3M Tape (Double Sided)
SOLD	As a Kit
WARRANTY	1 Year

Install using supplied 3M Tape.

## CASCADIA HOOD LATCH INSERT - ALL YEARS



STAINLESS STEEL  
**TF-1109**

### TECHNICAL SPECIFICATIONS

#### FREIGHTLINER MODEL

**CASCADIA** (All Years)

WHAT'S INCLUDED	3M Tape (Double Sided)
SOLD	Individually
WARRANTY	1 Year

Install using supplied 3M Tape.

## CASCADIA DOOR WINDOW SHADES



STAINLESS STEEL  
**TF-1410** 2008-2017  
**TF-1454** 2018+

### TECHNICAL SPECIFICATIONS

#### CASCADIA MODELS

**TF-1410:** With Passenger Side Downward Mirror (2008-2017)  
**TF-1454:** With/Without Passenger Side Downward Mirror (2018+)

WHAT'S INCLUDED	Hardware & 3M Tape (Double Sided)
SOLD	As a Pair
WARRANTY	1 Year

Install using supplied 3M Tape & Hardware.

## CASCADIA LOWER WINDOW TRIMS - ALL YEARS



STAINLESS STEEL  
**TF-1409**

### TECHNICAL SPECIFICATIONS

#### FREIGHTLINER MODELS

**CASCADIA** (All Years)

WHAT'S INCLUDED	3M Tape (Double Sided)
SOLD	As a Pair
WARRANTY	1 Year

Install using supplied 3M Tape.

**WARNING:** Cancer and Reproductive Harm - [www.p65warnings.ca.gov](http://www.p65warnings.ca.gov)

## CASCADIA 5" WINDOW CHOP TOPS



STAINLESS STEEL  
**TF-1437**

## CASCADIA SLEEPER DOOR TRIMS - ALL YEARS



STAINLESS STEEL  
**TF-1414**

## CASCADIA UPPER SLEEPER WINDOW TRIMS



STAINLESS STEEL  
**TF-1412** 2008-2017  
**TF-1455** 2018+

### TECHNICAL SPECIFICATIONS

#### FREIGHTLINER MODEL

**CASCADIA** (All Years)

WHAT'S INCLUDED	3M Tape (Double Sided)
SOLD	As a Pair
WARRANTY	1 Year

Install using supplied 3M Tape.

### TECHNICAL SPECIFICATIONS

#### FREIGHTLINER MODEL

**CASCADIA** (All Years)

WHAT'S INCLUDED	3M Tape (Double Sided)
SOLD	As a Kit
WARRANTY	1 Year

Install using supplied 3M Tape.

### TECHNICAL SPECIFICATIONS

#### FREIGHTLINER MODEL

**TF-1412:** CASCADIA (2008-2017)  
**TF-1455:** CASCADIA (2018+)

WHAT'S INCLUDED	3M Tape (Double Sided)
SOLD	As a Pair
WARRANTY	1 Year

Install using supplied 3M Tape.

## CASCADIA BAGGAGE DOOR TRIMS - ALL YEARS



STAINLESS STEEL  
**TF-1413**

### TECHNICAL SPECIFICATIONS

#### FREIGHTLINER MODEL

**CASCADIA** (All Years)

WHAT'S INCLUDED	3M Tape (Double Sided)
SOLD	As a Pair
WARRANTY	1 Year

Install using supplied 3M Tape.



# FREIGHTLINER TRIMS

## CENTURY GRILLE SURROUND ALL YEARS



STAINLESS STEEL  
**TF-1105**

### TECHNICAL SPECIFICATIONS

#### FREIGHTLINER MODEL

**CENTURY CLASS** (All Years)

WHAT'S INCLUDED	Grille Trim & Deflectors, All Hardware
SOLD	As a Kit (3 Pieces)
WARRANTY	1 Year

Drilling required. Install using supplied Hardware.

## CORONADO LOWER GRILLE TRIMS - PRE-2010



STAINLESS STEEL  
**TF-1108**

### TECHNICAL SPECIFICATIONS

#### FREIGHTLINER MODEL

**CORONADO** (Pre-2010)

WHAT'S INCLUDED	Hardware
SOLD	Individually
WARRANTY	1 Year

Install to the lower grille using supplied Hardware.

## CORONADO HEADLIGHT FENDER GUARDS



STAINLESS STEEL  
**TF-1209**



STAINLESS STEEL  
**TF-1210** Set Forward Axle



STAINLESS STEEL  
**TF-1212** Set Back Axle

### TECHNICAL SPECIFICATIONS

#### FREIGHTLINER MODELS

**TF-1209:** CORONADO (Pre-2010)

**TF-1210:** CORONADO Set Forward Axle (2010+)

**TF-1212:** CORONADO Set Back Axle (2010+)

WHAT'S INCLUDED	Hardware
SOLD	As a Pair
WARRANTY	1 Year

Install using supplied Hardware.

 **WARNING:** Cancer and Reproductive Harm - [www.p65warnings.ca.gov](http://www.p65warnings.ca.gov)

## CORONADO HEADLIGHT SURROUND FENDER GUARDS - 2010+



▲  
STAINLESS STEEL  
**TF-1211**

### TECHNICAL SPECIFICATIONS

#### SET FORWARD AXLE MODEL

**CORONADO** (2010+)

WHAT'S INCLUDED	Hardware
SOLD	As a Pair
WARRANTY	1 Year

Install using supplied Hardware.

## CORONADO UNDER DOOR WINDOW TRIMS - 2010+



▲  
STAINLESS STEEL  
**TF-1422**

### TECHNICAL SPECIFICATIONS

#### FREIGHTLINER MODEL

**CORONADO** (2010+)

WHAT'S INCLUDED	3M Tape (Double Sided)
SOLD	As a Pair
WARRANTY	1 Year

Install using supplied 3M Tape.

## CORONADO DOOR WINDOW SHADES - 2010+



▲  
STAINLESS STEEL  
**TF-1427**

### TECHNICAL SPECIFICATIONS

#### FREIGHTLINER MODEL

**CORONADO** (2010+)

WHAT'S INCLUDED	3M Tape (Double Sided)
SOLD	As a Pair
WARRANTY	1 Year

Install using supplied 3M Tape.

## CORONADO BATTERY BOX COVERS - PRE-2010



▲  
STAINLESS STEEL  
**TF-1608**

### TECHNICAL SPECIFICATIONS

#### FREIGHTLINER MODEL

**CORONADO** (Pre-2010)

DIMENSIONS	Width: 36"
WHAT'S INCLUDED	3M Tape (Double Sided) & Hardware
SOLD	Individually
WARRANTY	1 Year

Install using supplied 3M Tape & Hardware.

# FREIGHTLINER TRIMS

## COLUMBIA GRILLE PANEL OEM REPLACEMENT - ALL YEARS



STAINLESS STEEL  
**TF-1706**

### TECHNICAL SPECIFICATIONS

#### FREIGHTLINER MODEL

**COLUMBIA** (All Years)

SOLD	Individually
WARRANTY	1 Year

No mounting hardware is required.

## COLUMBIA HOOD & CAB TRIMS - ALL YEARS



STAINLESS STEEL  
**TF-1106**

### TECHNICAL SPECIFICATIONS

#### FREIGHTLINER MODEL

**COLUMBIA** (All Years)

WHAT'S INCLUDED	3M Tape (Double Sided)
SOLD	As a Kit (6 Pieces)
WARRANTY	1 Year

Install using supplied 3M Tape.

## COLUMBIA FENDER TRIMS - WHEEL WELL - ALL YEARS



STAINLESS STEEL  
**TFT-FLCOL**

### TECHNICAL SPECIFICATIONS

#### FREIGHTLINER MODEL

**COLUMBIA** (All Years)

WHAT'S INCLUDED	3M Tape (Double Sided)
SOLD	As a Pair
WARRANTY	1 Year

Install using supplied 3M Tape.

## COLUMBIA FENDER GUARDS ALL YEARS



STAINLESS STEEL  
**TF-1208**

### TECHNICAL SPECIFICATIONS

#### FREIGHTLINER MODEL

**COLUMBIA** (All Years)

WHAT'S INCLUDED	Hardware
SOLD	Individually
WARRANTY	1 Year

Mount onto the fender with supplied Hardware.

WARNING: Cancer and Reproductive Harm - [www.p65warnings.ca.gov](http://www.p65warnings.ca.gov)

## BUSINESS CLASS CHROME INTAKE GRILLE



▲  
STAINLESS STEEL  
**TF-1111**

### TECHNICAL SPECIFICATIONS

#### BUSINESS CLASS MODELS

**M2 106 & M2 112** (All Years)

DIMENSIONS	Length: 22.75"
SOLD	Individually
WARRANTY	1 Year

Install using existing Hardware. Replaces existing OEM Grille.

## FLD 120 SIDE GRILLE DEFLECTOR - 1991+



▲  
STAINLESS STEEL  
**TF-1104**

### TECHNICAL SPECIFICATIONS

#### FREIGHTLINER MODEL

**FLD 120** (1991+)

WHAT'S INCLUDED	Hardware
SOLD	Individually
WARRANTY	1 Year

Drilling is required. Install behind Grille Bezel using supplied Hardware.

## CLASSIC LOUVERED GRILLE BARS - 2006+



▲  
STAINLESS STEEL  
**TF-1003**

### TECHNICAL SPECIFICATIONS

#### FREIGHTLINER MODEL

**CLASSIC** (2006+)

WHAT'S INCLUDED	14 Bars & Hardware
SOLD	As a Kit
WARRANTY	1 Year

Install to the front fender using supplied Hardware.

## CLASSIC FENDER GUARDS - ALL YEARS



▲  
STAINLESS STEEL  
**TF-1203**

### TECHNICAL SPECIFICATIONS

#### SHORT HOOD MODELS

**CLASSIC** (All Years)

WHAT'S INCLUDED	Hardware Kit
SOLD	As a Pair
WARRANTY	1 Year

Mounts to the fender below the headlights.

## CLASSIC DOOR WINDOW SHADES - ALL YEARS



▲  
STAINLESS STEEL  
**TF-1401**

### TECHNICAL SPECIFICATIONS

#### FREIGHTLINER MODELS

**CLASSIC, XL FLD-112/120** (All Years)

WHAT'S INCLUDED	3M Tape (Double Sided) & Hardware
SOLD	As a Pair
WARRANTY	1 Year

Install using supplied 3M Tape & Hardware.

## CLASSIC BATTERY & TOOL BOX PANELS - 2007+



▲  
STAINLESS STEEL  
**TF-1601**

### TECHNICAL SPECIFICATIONS

#### FREIGHTLINER MODEL

**CLASSIC** (2007+)

DIMENSIONS	Width: 31"
WHAT'S INCLUDED	Silicone & Hardware
SOLD	As a Kit (4 Pieces)
WARRANTY	1 Year

Install panels to battery tool box with bolts & supplied Silicone Adhesive.

## 17" RAISED ROOF SUN VISOR - 2003-2018



STAINLESS STEEL  
**TSUN-V1** 8 x 6" Slotted

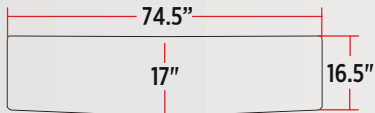

### TECHNICAL SPECIFICATIONS

#### RAISED ROOF MODELS

**VN670, VN730, VN780 & VT800** (2003-2018)

DIMENSIONS	Width: 74.5"   Sides: 16.5"   Drop: 17"
WHAT'S INCLUDED	2 x Sun Visor Brackets & All Hardware
WARRANTY	1 Year

OEM Replacement. Remove original factory brackets and install using TRUX brackets. For installation instructions visit our website.

## VN/VH SUN VISOR TRIM SUN VISOR - 2003-2014



STAINLESS STEEL  
**TSUN-V2**

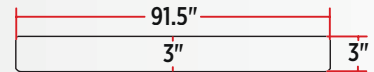

### TECHNICAL SPECIFICATIONS

#### RAISED ROOF OEM REPLACEMENT MODELS

**ALL VN & VH MODELS** (2003-2014)

DIMENSIONS	Width: 91.5"   Sides: 3"   Drop: 3"
WHAT'S INCLUDED	3M Tape (Double Sided) & Hardware
WARRANTY	1 Year

Install using 3M Tape & supplied Hardware.

## VN BUG DEFLECTOR HOOD SHIELD - 2003-2018



STAINLESS STEEL  
**THOD-VN**

### TECHNICAL SPECIFICATIONS

#### VOLVO MODELS

**VN630, VN670, VN730 & VN780** (2003-2018)

DIMENSIONS	Width: 58"
WHAT'S INCLUDED	All Hardware
WARRANTY	1 Year

Drilling of mounting holes through the hood is required. Install using supplied Hardware.

## SLEEPER CAB TRIM 2003-2018



STAINLESS STEEL  
**TV-1404**

### TECHNICAL SPECIFICATIONS

#### VOLVO MODELS

**VN730, VN780 & VT880** (2003-2018)

WHAT'S INCLUDED	3M Tape (Double Sided)
SOLD	As a Pair
WARRANTY	1 Year

Install using 3M Tape.



## VN SURROUND BUG DEFLECTOR & GRILLE KIT



STAINLESS STEEL  
**TV-1104**

### TECHNICAL SPECIFICATIONS

#### VOLVO MODELS

**VN 630, VN670, VN730 & VN780**  
(2003-2018)

WHAT'S INCLUDED	Hardware Kit
SOLD	As a Kit (4 Pieces)
WARRANTY	1 Year

Designed with a built in grab handle for hood tilting.  
Drilling of mounting holes through the hood is required.

## VN/VT FENDER GUARDS - 2003-2018



STAINLESS STEEL  
**TV-1203**

### TECHNICAL SPECIFICATIONS

#### VOLVO MODELS

**VN 730, VN780 & VT880** (2003-2018)

WHAT'S INCLUDED	3M Tape (Double Sided)
SOLD	As a Pair
WARRANTY	1 Year

Install using 3M Tape.

## VN BUMPER CENTRAL TRIM - 2003-2018



STAINLESS STEEL  
**TV-1701**

### TECHNICAL SPECIFICATIONS

#### VOLVO MODELS

**ALL VN MODELS** (2003-2018)

WHAT'S INCLUDED	3M Tape (Double Sided)
SOLD	Individually
WARRANTY	1 Year

Install using 3M Tape.

## VN AIR INTAKE GRILLE 2003-2018



CHROME PLASTIC  
**TV-1102** Driver Side



CHROME PLASTIC  
**TV-1103** Passenger Side

### TECHNICAL SPECIFICATIONS

#### VOLVO MODELS

**ALL VN MODELS** (2003-2018)

WHAT'S INCLUDED	3M Tape (Double Sided)
SOLD	Individually
WARRANTY	1 Year

Install using 3M Tape.

## VN FENDER TRIMS SIDE FAIRING - 2003-2018



STAINLESS STEEL  
**TFT-VN**

### TECHNICAL SPECIFICATIONS

#### MODELS WITH SIDE FAIRING

**ALL VN MODELS** (2003-2018)

WHAT'S INCLUDED	3M Tape (Double Sided)
SOLD	As a Pair
WARRANTY	1 Year

Install using 3M Tape.

## VN UPPER KICK PLATE PANELS 2003-2018



STAINLESS STEEL  
**TV-1406**

### TECHNICAL SPECIFICATIONS

#### VOLVO MODELS

**ALL VN MODELS** (2003-2018)

WHAT'S INCLUDED	3M Tape (Double Sided)
SOLD	As a Pair
WARRANTY	1 Year

Install using 3M Tape.



STAINLESS STEEL  
**TV-1436** With Volvo Cutout

### TECHNICAL SPECIFICATIONS

#### VOLVO MODELS

**ALL VN MODELS** (2003-2018)

WHAT'S INCLUDED	3M Tape (Double Sided)
SOLD	As a Pair
WARRANTY	1 Year

## VN LOWER KICK PLATE PANELS 2006-2018



STAINLESS STEEL  
**TV-1408** Front

### TECHNICAL SPECIFICATIONS

#### VOLVO MODELS

**ALL VN MODELS** (2006-2018)

WHAT'S INCLUDED	3M Tape (Double Sided)
SOLD	As a Pair
WARRANTY	1 Year

Install using 3M Tape.



STAINLESS STEEL  
**TV-1421** Rear

### TECHNICAL SPECIFICATIONS

#### VOLVO MODELS

**ALL VN MODELS** (2006-2018)

WHAT'S INCLUDED	3M Tape (Double Sided)
SOLD	As a Pair
WARRANTY	1 Year

## VN/VNL/VT DOOR HANDLE TRIMS



STAINLESS STEEL  
**TV-1413**

### TECHNICAL SPECIFICATIONS

#### VOLVO MODELS

**VN, VNL & VT** (2003-2018)

WHAT'S INCLUDED	3M Tape (Double Sided)
SOLD	As a Pair
WARRANTY	1 Year

Install using 3M Tape.

## VN630/VN670 SLEEPER VENT TRIMS



STAINLESS STEEL  
**TV-1415**

### TECHNICAL SPECIFICATIONS

#### VOLVO MODELS

**VN630 & VN670** (2003-2018)

WHAT'S INCLUDED	3M Tape (Double Sided)
SOLD	As a Pair
WARRANTY	1 Year

Install using 3M Tape.

## VN730/VN780 UPPER FAIRING TRIMS



STAINLESS STEEL  
**TV-1440** 18 x Slotted Holes

### TECHNICAL SPECIFICATIONS

#### VOLVO MODELS

**VN730 & VN780** (2006-2011)

DIMENSIONS	Step: 17.5" Front Fender: 13.06" Front Step: 62.25" Sleeper: 69.125" Rear Step: 22.5
WHAT'S INCLUDED	3M Tape (Double Sided) & Hardware
SOLD	As a Kit (8 Pieces)
WARRANTY	1 Year

## VN DOOR WINDOW SHADES PRE-2018



STAINLESS STEEL  
**TV-1462**

### TECHNICAL SPECIFICATIONS

#### VOLVO MODELS

**ALL VN MODELS** (Pre- 2018)

WHAT'S INCLUDED	3M Tape (Double Sided)
SOLD	As a Pair
WARRANTY	1 Year

Install using 3M Tape.

## VN730/VN780 CAB & SLEEPER PANELS - 2003-2010



STAINLESS STEEL  
**TV-1002** 16 x Slotted Holes

### TECHNICAL SPECIFICATIONS

#### VOLVO MODELS

**VN730 & VN780** (2003-2010)

DIMENSIONS	L: 43"   W: 4"
WHAT'S INCLUDED	Hardware Kit
SOLD	As a Kit (4 Pieces)
WARRANTY	1 Year

Install using supplied Hardware.

# INTERNATIONAL

## 12" OEM SUN VISOR - 2008+



STAINLESS STEEL  
**TSUN-I1** 5 x Slotted Holes

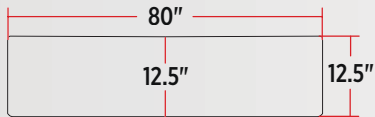

### TECHNICAL SPECIFICATIONS

#### OEM VISOR MODELS

**LONESTAR, PROSTAR, TERRASTAR, WORKSTAR** (2008+)

DIMENSIONS	Width: 80"   Sides: 12.5"   Drop: 12.5"
WHAT'S INCLUDED	4 x Sun visor Brackets & All Hardware
WARRANTY	1 Year

Install by removing the original factory brackets & using Trux brackets. Visit our website to download the installation instructions.

## 11" 9000 SERIES SUN VISOR - PRE-1999



STAINLESS STEEL  
**TSUN-I2**

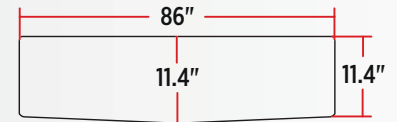

### TECHNICAL SPECIFICATIONS

#### LOW ROOF/HIGH RISE/DAY CAB MODELS

**9000 SERIES** (Pre-1999)

DIMENSIONS	Width: 86"   Sides: 11.4"   Drop: 11.4"
WHAT'S INCLUDED	5 x Sun visor Brackets & All Hardware
WARRANTY	1 Year

Install by removing the original factory brackets & using Trux brackets. Visit our website to download the installation instructions.

## 12.5" 9000 SERIES SUN VISOR - 1999+



STAINLESS STEEL  
**TSUN-I5** Blank  
**TSUN-I7** 8 x Slotted Holes

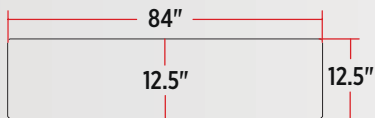

### TECHNICAL SPECIFICATIONS

#### LOW ROOF/HIGH RISE/SKY RISE MODELS

**9000 SERIES** (1999+)

DIMENSIONS	Width: 84"   Sides: 12.5"   Drop: 12.5"
WHAT'S INCLUDED	5 x Sun visor Brackets & All Hardware
WARRANTY	1 Year

Install by removing the original factory brackets & using Trux brackets. Visit our website to download the installation instructions.

## 12" 9000 SERIES DAY CAB WITH ROOF DEFLECTOR - 1999+



STAINLESS STEEL  
**TSUN-I8** Blank  
**TSUN-I9** 5 x Slotted Holes

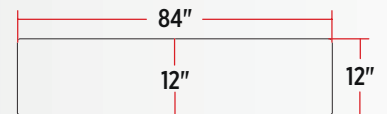

### TECHNICAL SPECIFICATIONS

#### DAY CAB WITH ROOF DEFLECTOR MODELS

**9000 SERIES** (1999+)

DIMENSIONS	Width: 84"   Sides: 12"   Drop: 12."
WHAT'S INCLUDED	5 x Sun visor Brackets & All Hardware
WARRANTY	1 Year

Install by removing the original factory brackets & using Trux brackets. Visit our website to download the installation instructions.

**WARNING:** Cancer and Reproductive Harm - [www.p65warnings.ca.gov](http://www.p65warnings.ca.gov)

## 12" 4000 SERIES SUN VISOR - 2002+



STAINLESS STEEL

- TSUN-I11** Blank
- TSUN-I12** 5 x 2" Holes
- TSUN-I10** 6 x Slotted Holes
- TSUN-I18** 20 x 3/4" Holes

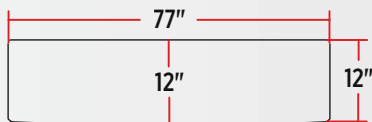

### TECHNICAL SPECIFICATIONS

#### INTERNATIONAL MODELS

**4000 SERIES** (2002+)

DIMENSIONS	Width: 77"   Sides: 12"   Drop: 12"
WHAT'S INCLUDED	4 x Sun visor Brackets & All Hardware
WARRANTY	1 Year

Install by removing the original factory brackets & using Trux brackets. Visit our website to download the installation instructions.

## PROSTAR BUG DEFLECTOR HOOD SHIELD - 2008+



STAINLESS STEEL

**THOD-INPR**

### TECHNICAL SPECIFICATIONS

#### INTERNATIONAL MODEL

**PROSTAR** (2008+)

DIMENSIONS	Width: 57.38"
WHAT'S INCLUDED	All Hardware
WARRANTY	1 Year

Install using supplied Hardware. Drilling into hood is required.

## 4000 SERIES BUG DEFLECTOR HOOD SHIELD - 2002+



STAINLESS STEEL

**THOD-IN40**

### TECHNICAL SPECIFICATIONS

#### INTERNATIONAL MODELS

**4000 SERIES** (2002+)

DIMENSIONS	Width: 56.625"
WHAT'S INCLUDED	All Hardware
WARRANTY	1 Year

Install using supplied Hardware. Drilling into hood is

## LONESTAR BUG DEFLECTOR HOOD SHIELD - ALL YEARS



STAINLESS STEEL

**THOD-INLS**

### TECHNICAL SPECIFICATIONS

#### INTERNATIONAL MODEL

**LONESTAR** (All Years)

DIMENSIONS	Width: 35" per Side
WHAT'S INCLUDED	All Hardware
WARRANTY	1 Year

Install using supplied Hardware. Drilling into hood is required.

# INTERNATIONAL

## BUG DEFLECTOR HOOD SHIELD - ALL YEARS



STAINLESS STEEL  
**THOD-IN92**

### TECHNICAL SPECIFICATIONS

#### INTERNATIONAL MODELS

**5900 ROUND HOOD, 9100, 9200 & 9400** (All Years)

DIMENSIONS	Width: 60.21"
WHAT'S INCLUDED	All Hardware
WARRANTY	1 Year

Install using supplied Hardware. Drilling into hood is required.

## 5900 ROUND HOOD/9400 BUG DEFLECTOR HOOD SHIELD - ALL YEARS



STAINLESS STEEL  
**THOD-IN94**

### TECHNICAL SPECIFICATIONS

#### INTERNATIONAL MODELS

**5900 ROUND HOOD & 9400** (All Years)

DIMENSIONS	Width: 60.21"
WHAT'S INCLUDED	All Hardware
WARRANTY	1 Year

Install using supplied Hardware. Drilling into hood is required.

## 9300 BUG DEFLECTOR HOOD SHIELD - ALL YEARS



STAINLESS STEEL  
**THOD-IN93**

### TECHNICAL SPECIFICATIONS

#### INTERNATIONAL MODEL

**9300** (All Years)

DIMENSIONS	Width: 55.56"
WHAT'S INCLUDED	All Hardware
WARRANTY	1 Year

Install using supplied Hardware. Drilling into hood is required.

## BUG DEFLECTOR HOOD SHIELD



STAINLESS STEEL  
**THOD-IN99**

### TECHNICAL SPECIFICATIONS

#### INTERNATIONAL MODELS

**HX520** (2017+)  
**5900 FLAT HOOD, 9900 & 9900i** (All Years)

DIMENSIONS	Width: 59.2"
WHAT'S INCLUDED	All Hardware
WARRANTY	1 Year

Install using supplied Hardware. Drilling into hood is required.

**WARNING: Cancer and Reproductive Harm - [www.p65warnings.ca.gov](http://www.p65warnings.ca.gov)**

## 4000 SERIES/DURASTAR BUMPER BAR



STAINLESS STEEL  
**TI-1703** 16 x 2" Holes

### TECHNICAL SPECIFICATIONS

#### INTERNATIONAL MODELS

**4000 SERIES & DURASTAR** (All Years)

SOLD	Individually
WARRANTY	1 Year

Drilling maybe required.

## PROSTAR BUMPER INSERT - PRE-2012



STAINLESS STEEL  
**TI-1708**

### TECHNICAL SPECIFICATIONS

#### INTERNATIONAL MODEL

**PROSTAR** (Pre-2012)

WHAT'S INCLUDED	3M Tape (Double Sided)
SOLD	Individually
WARRANTY	1 Year

Install using supplied 3M Tape.

## 9900I/9900IX GRILLE HORIZONTAL BARS



STAINLESS STEEL  
**TI-1103**

### TECHNICAL SPECIFICATIONS

#### INTERNATIONAL MODELS

**9900I & 9900IX** (All Years)

WHAT'S INCLUDED	Grille Bars & Bug Screen
SOLD	Individually
WARRANTY	1 Year

Sold completely assembled with the bug screen included.  
Install using existing Hardware.

## AIR FILTER SHROUDS



STAINLESS STEEL  
**TI-1104**

### TECHNICAL SPECIFICATIONS

#### MODELS WITH AIR FILTER

**9300/9900** (2016+)  
**HX515, HX520, HX615 & HX620**  
(2016+)

WHAT'S INCLUDED	Hardware Kit
SOLD	As a Pair
WARRANTY	1 Year

Install using supplied Hardware.

## PROSTAR CAB PANELS 2007+



STAINLESS STEEL  
**TI-1301** 4 x Slotted Holes

### TECHNICAL SPECIFICATIONS

#### INTERNATIONAL MODEL

**PROSTAR** (2007+)

DIEMENSIONS	L: 36"   W: 5.6"
SOLD	As a Pair
WARRANTY	1 Year

Mount underneath cab, drilling maybe required.

## LONESTAR/PROSTAR BAGGAGE DOOR TRIMS



STAINLESS STEEL  
**TI-1411** Inner Trim

### TECHNICAL SPECIFICATIONS

#### 56" & 73" SLEEPER MODELS

**LONESTAR & PROSTAR** (All Years)

WHAT'S INCLUDED	3M Tape (Double Sided)
SOLD	As a Pair
WARRANTY	1 Year

Install using supplied 3M Tape.

## 13" SUN VISOR ALL YEARS



STAINLESS STEEL  
**TSUN-M1**

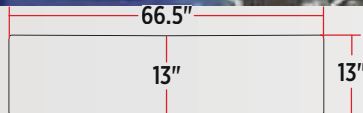

### TECHNICAL SPECIFICATIONS

#### MACK MODELS

**GRANITE CH/CL/CX/CT/GU** With Roof Fairings (All Years)  
**ANTHEM** Without Roof Fairings (All Years)

DIMENSIONS	Width: 66.5"   Sides: 13"   Drop: 13"
WHAT'S INCLUDED	8 x Sun Visor Brackets & All Hardware
WARRANTY	1 Year

2 Piece Sun visor. Visit our website at [www.truxaccessories.com](http://www.truxaccessories.com) for Installation Instructions.

## 7.5" R SERIES SUN VISOR - 1994+



STAINLESS STEEL  
**TSUN-M2**

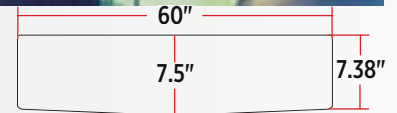

### TECHNICAL SPECIFICATIONS

#### MACK MODELS

**R SERIES** (1994+)

DIMENSIONS	Width: 60"   Sides: 7.38"   Drop: 7.5"
WHAT'S INCLUDED	3 x Sun Visor Brackets & All Hardware
WARRANTY	1 Year

Installation does not require drilling, remove the original factory brackets & use TRUX brackets. Visit our website at [www.truxaccessories.com](http://www.truxaccessories.com) for Installation Instructions.

## 12" R SERIES SUN VISOR - PRE-2006



STAINLESS STEEL  
**TSUN-M3**

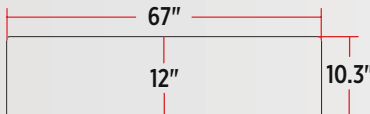

### TECHNICAL SPECIFICATIONS

#### MACK MODELS

**R SERIES** (Pre-2006)

DIMENSIONS	Width: 67"   Sides: 10.3"   Drop: 12"
WHAT'S INCLUDED	4 x Sun Visor Brackets & All Hardware
WARRANTY	1 Year

2 Piece Sun Visor. Visit our website at [www.truxaccessories.com](http://www.truxaccessories.com) for Installation Instructions.

## PINNACLE/VISION AIR INTAKE TRIMS - ALL YEARS



STAINLESS STEEL  
**TM-1102** Outer Air Intake Trim  
**TM-1417** Inner Air Intake Trim

### TECHNICAL SPECIFICATIONS

#### MACK MODELS

**PINNACLE** (All Years)  
**VISION** (All Years)

WHAT'S INCLUDED	3M Tape (Double Sided)
SOLD	As a Kit
WARRANTY	1 Year

Install using supplied 3M Tape.

**WARNING:** Cancer and Reproductive Harm - [www.p65warnings.ca.gov](http://www.p65warnings.ca.gov)



## CT/GU BUG DEFLECTOR HOOD SHIELD



▲  
STAINLESS STEEL  
**THOD-MGCT**

### TECHNICAL SPECIFICATIONS

#### MACK MODEL

**GRANITE CT** (2006-2010)  
**GRANITE GU** (2011+)

DIMENSIONS	Width: 60.76"
WHAT'S INCLUDED	All Hardware
WARRANTY	1 Year

Drilling of mounting holes through the hood is required. Install using supplied Hardware.

## CH BUG DEFLECTOR HOOD SHIELD - PRE-2016



▲  
STAINLESS STEEL  
**THOD-MCH**

### TECHNICAL SPECIFICATIONS

#### MACK MODEL

**CH** (Pre-2016)

DIMENSIONS	Width: 52.2"
WHAT'S INCLUDED	All Hardware
WARRANTY	1 Year

Drilling of mounting holes through the hood is required. Install using supplied Hardware.

## CH AIR INTAKE GRILLE TRIMS - OEM REPLACEMENT



▲  
STAINLESS STEEL  
**TM-1412** Grille  
**TM-1427** Grille Surround with Logo

### TECHNICAL SPECIFICATIONS

#### MACK MODEL

**CH** (All Years)

WHAT'S INCLUDED	Hardware Kit
SOLD	As a Pair
WARRANTY	1 Year

Replace OEM plastic panels with TRUX Stainless panels by installing with supplied Hardware.

## VISION GRILLE SURROUND - PRE-2007



▲  
STAINLESS STEEL  
**TM-1101**

### TECHNICAL SPECIFICATIONS

#### MACK MODEL

**VISION** (Pre-2007)

WHAT'S INCLUDED	Hardware Kit
SOLD	As a Pair
WARRANTY	1 Year

Acts as a Bug & Grille Deflector. Drilling into the hood may be required. Install to the hood using supplied Hardware.

## CH GRILLE SURROUND - ALL YEARS



▲  
STAINLESS STEEL  
**TM-1107**

### TECHNICAL SPECIFICATIONS

#### SET FORWARD AXLE MODEL

**CH** (All Years)

WHAT'S INCLUDED	Hardware Kit
SOLD	As a Kit (4 Pieces)
WARRANTY	1 Year

Acts as a Bug & Grille Deflector. Drilling into the hood may be required. Install to the hood using supplied Hardware.

## VISION FENDER TRIMS 1993+



STAINLESS STEEL  
**TFT-MVIS**

### TECHNICAL SPECIFICATIONS

#### MACK MODEL

**VISION** (1993+)

WHAT'S INCLUDED	3M Tape (Double Sided)
SOLD	As a Kit
WARRANTY	1 Year

Install using supplied 3M Tape.

## CH FENDER GUARDS SET FORWARD AXLE - ALL YEARS



STAINLESS STEEL  
**TM-1202**

### TECHNICAL SPECIFICATIONS

#### SET FORWARD AXLE MODEL

**CH** (All Years)

WHAT'S INCLUDED	Hardware & 3M Tape (Double Sided)
SOLD	As a Pair
WARRANTY	1 Year

Install using supplied 3M Tape & Hardware.

## KICK PLATES WITH MACK CUT-OUT ALL YEARS



STAINLESS STEEL  
**TM-1605** Old Logo



STAINLESS STEEL  
**TM-1606** New Logo

### TECHNICAL SPECIFICATIONS

#### MACK MODELS

**ANTHEM, GRANITE, PINNACLE, RAWHIDE & VISION** (All Years)

WHAT'S INCLUDED	3M Tape (Double Sided)
SOLD	As a Pair
WARRANTY	1 Year

Install using supplied 3M Tape & existing Hardware.

## FIRE WALL LIGHT BARS - ALL YEARS



STAINLESS STEEL  
**TM-1801** 16 x 2" Holes  
**TM-1802** 16 x 3/4" Holes

### TECHNICAL SPECIFICATIONS

#### MACK MODELS

**ALL MODELS** (All Years)

DIMENSIONS	15.5" High
WHAT'S INCLUDED	Hardware Kit
SOLD	As a Pair
WARRANTY	1 Year

Install using supplied Hardware.

## DOOR HANDLE TRIMS 1993+



STAINLESS STEEL  
**TM-1403**

### TECHNICAL SPECIFICATIONS

#### MACK MODELS

**GRANITE, PINNACLE, VISION & ANTHEM** (1993+)

WHAT'S INCLUDED	3M Tape (Double Sided)
SOLD	As a Pair
WARRANTY	1 Year

Install using supplied 3M Tape.

## DOOR WINDOW SHADES ALL YEARS



STAINLESS STEEL  
**TM-1413**

### TECHNICAL SPECIFICATIONS

#### MACK MODELS

**ANTHEM, CH, GRANITE & VISION** (All Years)

WHAT'S INCLUDED	3M Tape (Double Sided)
SOLD	As a Pair
WARRANTY	1 Year

Install using supplied 3M Tape & Hardware.

## GRANITE / ANTHEM DOOR WINDOW TRIMS



STAINLESS STEEL  
**TM-1429**

### TECHNICAL SPECIFICATIONS

#### MACK MODELS

**GRANITE** (2002+) **ANTHEM** (2019+)

WHAT'S INCLUDED	3M Tape (Double Sided)
SOLD	As a Pair
WARRANTY	1 Year

Install using supplied 3M Tape.

## GRANITE INTAKE GRILLE ALL YEARS



STAINLESS STEEL  
**TM-1109** Driver Side  
**TM-1110** Passenger Side

### TECHNICAL SPECIFICATIONS

#### OLDER STYLE HOOD MODELS

**GRANITE** (All Years)

WHAT'S INCLUDED	3M Tape (Double Sided)
SOLD	Individually
WARRANTY	1 Year

Install using supplied 3M Tape.

# WESTERN STAR

## 13.5" FLAT TOP SUN VISOR - 1998+ EXCEPT 2006



STAINLESS STEEL  
**TSUN-W1**

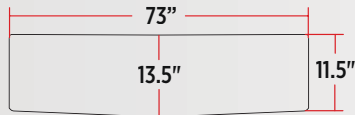

### TECHNICAL SPECIFICATIONS

#### MODELS WITH DOOR MOUNTED MIRRORS

**CONSTELLATION & STRATOSPHERE** (1998+ except 2006)

DIMENSIONS	Width: 73"   Sides: 11.5   Drop: 13.5"
WHAT'S INCLUDED	5 x Sun Visor Brackets & All Hardware
WARRANTY	1 Year

Visit our website at [www.truxaccessories.com](http://www.truxaccessories.com) for Installation Instructions. Drilling may be required.

## 11" HERITAGE SUN VISOR - 1987-2006



STAINLESS STEEL  
**TSUN-W2**



### TECHNICAL SPECIFICATIONS

#### MODELS WITH OEM SUN VISOR

**HERITAGE** (1987-2006)

DIMENSIONS	Width: 63"   Sides: 11"   Drop: 11"
WHAT'S INCLUDED	6 x Sun Visor Brackets & All Hardware
WARRANTY	1 Year

Will NOT fit EPA-2007 Models. Visit our website at [www.truxaccessories.com](http://www.truxaccessories.com) for Installation Instructions. Drilling may be required.

## 16" STRATOSPHERE SUN VISOR - ALL YEARS



STAINLESS STEEL  
**TSUN-W3**

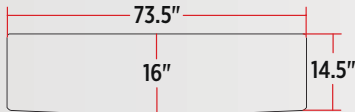

### TECHNICAL SPECIFICATIONS

#### STRATOSPHERE MODELS WITH OEM SUN VISOR

**STRATOSPHERE** (All Years)

DIMENSIONS	Width: 73.5"   Sides: 14.5"   Drop: 16"
WHAT'S INCLUDED	5 x Sun Visor Brackets & All Hardware
WARRANTY	1 Year

Visit our website at [www.truxaccessories.com](http://www.truxaccessories.com) for Installation Instructions. Drilling may be required.

## 15" MID ROOF SUN VISOR - ALL YEARS



STAINLESS STEEL  
**TSUN-W8**



### TECHNICAL SPECIFICATIONS

#### MODELS WITH CAB MOUNTED MIRRORS

**ALL MODELS** (All Years)

DIMENSIONS	Width: 77"   Sides: 13"   Drop: 15"
WHAT'S INCLUDED	5 x Sun Visor Brackets & All Hardware
WARRANTY	1 Year

In addition this Sun Visor is sold with 1 Center Leg and 1 Reinforcement Bar that holds the 2 piece windshield. Visit our website at [www.truxaccessories.com](http://www.truxaccessories.com) for Installation Instructions. Drilling may be required.

**WARNING:** Cancer and Reproductive Harm - [www.p65warnings.ca.gov](http://www.p65warnings.ca.gov)

## BUG DEFLECTOR HOOD SHIELD - 2000+



▲  
STAINLESS STEEL  
**THOD-WCF**

### TECHNICAL SPECIFICATIONS

#### WESTERN STAR MODELS

**CONSTELLATION, HERITAGE,  
4964 & 4900 (FX/FA, EX, SX/SA) (2000+)**

DIMENSIONS	Width: 49"
WHAT'S INCLUDED	All Hardware
WARRANTY	1 Year

Will not fit on models with high visibility hoods or SD models. Drilling of mounting holes through the hood is required.

## 4900EX/FA BUG DEFLECTOR HOOD SHIELD - 1993-2011



▲  
STAINLESS STEEL  
**THOD-WH**

### TECHNICAL SPECIFICATIONS

#### WESTERN STAR MODELS

**4900EX & 4900FA (1993-2011)**

DIMENSIONS	Width: 48"
WHAT'S INCLUDED	All Hardware
WARRANTY	1 Year

Drilling of mounting holes through the hood is required.

## 4700SB/SF BUG DEFLECTOR HOOD SHIELD - 2012+



▲  
STAINLESS STEEL  
**THOD-WSB**

### TECHNICAL SPECIFICATIONS

#### WESTERN STAR MODELS

**4700SB & 4700SF (2012+)**

DIMENSIONS	Width: 54"
WHAT'S INCLUDED	All Hardware
WARRANTY	1 Year

Drilling of mounting holes through the hood is required.

## 4900CO BUG DEFLECTOR HOOD SHIELD - 1993-2011



▲  
STAINLESS STEEL  
**THOD-WC**

### TECHNICAL SPECIFICATIONS

#### WESTERN STAR MODEL

**4900CO (1993-2011)**

DIMENSIONS	Width: 46.5"
WHAT'S INCLUDED	All Hardware
WARRANTY	1 Year

Drilling of mounting holes through the hood is required.

# WESTERN STAR

## 4900EX GRILLE KIT REPLACES OEM - 1995+



STAINLESS STEEL  
**TW-1101**

### TECHNICAL SPECIFICATIONS

#### WESTERN STAR MODEL

**4900EX** OEM 67205-3479 & 67205-3481

DIMENSIONS	W: 42"   H: 33.59"
WHAT'S INCLUDED	Brackets and Hardware
SOLD	As a Kit
WARRANTY	1 Year

Install using supplied Hardware. Drilling may be required.  
NOTE: Does not include the Bug Deflector.

## 4700SB GRILLE SURROUND 2012+



STAINLESS STEEL  
**TW-1105**

### TECHNICAL SPECIFICATIONS

#### WESTERN STAR MODEL

**4700SB** (2012+)

WHAT'S INCLUDED	Hardware
SOLD	As a Kit
WARRANTY	1 Year

Install using supplied hardware. Drilling may be required.

## CONSTELLATION HEADLIGHT FENDER GUARDS - 1996-2009



STAINLESS STEEL  
**TW-1203**

### TECHNICAL SPECIFICATIONS

#### WESTERN STAR MODEL

**CONSTELLATION** (1996-2009)

WHAT'S INCLUDED	Hardware
SOLD	As a Pair
WARRANTY	1 Year

Install using supplied Hardware. Drilling into hood is required.

## 4900EX/4900FA FENDER GUARDS - 2014-2018



STAINLESS STEEL  
**TW-1207**

### TECHNICAL SPECIFICATIONS

#### WESTERN STAR MODELS

**4900EX & 4900FA** (2014-2018)

WHAT'S INCLUDED	Hardware
SOLD	As a Pair
WARRANTY	1 Year

Install using supplied Hardware. Drilling into hood is required.

WARNING: Cancer and Reproductive Harm - [www.p65warnings.ca.gov](http://www.p65warnings.ca.gov)

## CAB MOUNTED WINDOW SHADES - ALL YEARS



STAINLESS STEEL  
**TW-1401**

### TECHNICAL SPECIFICATIONS

#### MODELS WITH CAB MOUNTED MIRRORS

**ALL MODELS** (All Years)

WHAT'S INCLUDED	3M Tape (Double Sided)
SOLD	As a Pair
WARRANTY	1 Year

Install using supplied 3M Tape. Drilling may be required.

## DOOR MOUNTED WINDOW SHADES - ALL YEARS



STAINLESS STEEL  
**TW-1404**

### TECHNICAL SPECIFICATIONS

#### MODELS WITH DOOR MOUNTED MIRRORS

**ALL MODELS** (All Years)

WHAT'S INCLUDED	3M Tape (Double Sided)
SOLD	As a Pair
WARRANTY	1 Year

Install using supplied 3M Tape. Drilling may be required.

## 5" WINDOW CHOP TOPS 1998+



STAINLESS STEEL  
**TW-1407**

### TECHNICAL SPECIFICATIONS

#### MODELS WITH CAB MOUNTED MIRRORS

**ALL MODELS** (1998+)

WHAT'S INCLUDED	3M Tape (Double Sided)
SOLD	As a Pair
WARRANTY	1 Year

Install using supplied 3M Tape.

## DOOR WINDOW TRIMS 2000+



STAINLESS STEEL  
**TW-1411**

### TECHNICAL SPECIFICATIONS

#### WESTERN STAR MODELS

**ALL MODELS** (2000+)

WHAT'S INCLUDED	3M Tape (Double Sided)
SOLD	As a Pair
WARRANTY	1 Year

Install using supplied 3M Tape.

**NEW**

STAY WARM WITH TRUX APPAREL

BOMBER  
JACKET

SOFT SHELL  
JACKET

SAFETY  
PARKA

# HEATED JACKETS

FRONT & BACK  
MULTI-ZONE  
HEATING ELEMENTS



**MULTI-ZONE HEATING**  
UP TO 11\* HOURS OF HEAT  
\*HEAT DURATION VARIES BASED ON JACKET MODEL



**BREATHABLE,  
WATER & WIND RESISTANT**



**M, L, XL, XXL**  
SIZES AVAILABLE

**3 HEAT SETTINGS**  
BUTTON FOUND DISCRETELY IN THE JACKET



LOW



MEDIUM



HIGH

RECHARGEABLE  
**POWER BANK** INCLUDED





## SOFT SHELL JACKET

BLACK - HEATED



**BLACK HEATED SOFT SHELL JACKET**  
**TT-105M** Medium  
**TT-105L** Large  
**TT-105XL** XL  
**TT-1052XL** XXL

### TECHNICAL SPECIFICATIONS

COLOR	Black
FUNCTION	3 Setting Heated Jacket
HEAT DURATION	Up to 7 Hours
MATERIAL	Shell: 94% Polyester, 6% Spandex Lining & Insulation: 100% Polyester
WASHING INSTRUCTIONS	Machine Washable, Gentle Cycle
WHAT'S INCLUDED	USB Power Bank & Charging Cable
POWER BANK	5V - 10,000 mAh (TT-109) Power Bank Certification: FCC, CE, RoHS Power Cell Certification: UL Certified
SOLD	Individually
WARRANTY	1 Year

### BODY SIZE GUIDE

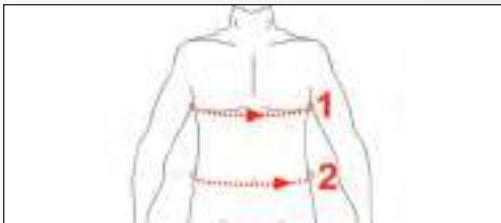

SIZE	M	L	XL	XXL
<b>1</b>	42" - 43"	44" - 45"	46" - 47"	48" - 49"
<b>2</b>	38" - 39"	40" - 41"	42" - 43"	43" - 44"

## BOMBER JACKET

ORANGE - HEATED



**ORANGE HEATED BOMBER JACKET**  
**TT-104M** Medium  
**TT-104L** Large  
**TT-104XL** XL  
**TT-1042XL** XXL

### TECHNICAL SPECIFICATIONS

COLOR	Orange
FUNCTION	3 Setting Heated Jacket
HEAT DURATION	Up to 7 Hours
MATERIAL	Outer Shell, Lining & Insulation: 100% Polyester, 3M Reflective Tape
WASHING INSTRUCTIONS	Machine Washable, Gentle Cycle
WHAT'S INCLUDED	USB Power Bank & Charging Cable
POWER BANK	5V - 10,000 mAh (TT-101) Power Bank Certification: FCC, CE, RoHS Power Cell Certification: UL Certified
SOLD	Individually
WARRANTY	1 Year

### BODY SIZE GUIDE

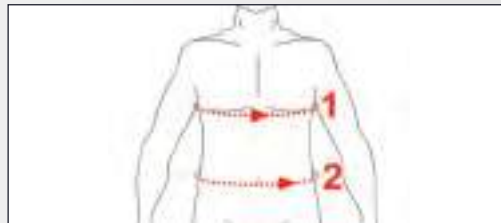

SIZE	M	L	XL	XXL
<b>1</b>	41" - 43"	44" - 46"	47" - 49"	50" - 52"
<b>2</b>	37" - 39"	40" - 42"	43" - 45"	46" - 48"

## SAFETY PARKA

YELLOW - HEATED



**YELLOW HEATED SAFETY PARKA**  
**TT-103M** Medium  
**TT-103L** Large  
**TT-103XL** XL  
**TT-1032XL** XXL

### TECHNICAL SPECIFICATIONS

COLOR	Yellow
FUNCTION	3 Setting Heated Jacket
HEAT DURATION	Up to 11 Hours
MATERIAL	Outer Shell, Lining & Insulation: 100% Polyester, 3M Reflective Tape
WASHING INSTRUCTIONS	Machine Washable, Gentle Cycle
WHAT'S INCLUDED	USB Power Bank & Charging Cable
POWER BANK	5V - 20,000 mAh (TT-102) Power Bank Certification: FCC, CE, RoHS Power Cell Certification: UL Certified
SOLD	Individually
WARRANTY	1 Year

### BODY SIZE GUIDE

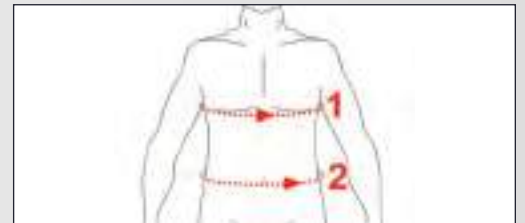

SIZE	M	L	XL	XXL
<b>1</b>	41" - 43"	44" - 46"	47" - 49"	50" - 52"
<b>2</b>	37" - 39"	40" - 42"	43" - 45"	46" - 48"

# APPAREL

## VEST LINER BLACK - HEATED



WEAR  
UNDERNEATH  
YOUR JACKET!

**BLACK HEATED VEST LINER**  
**TT-106M** Medium  
**TT-106L** Large  
**TT-106XL** XL  
**TT-1062XL** XXL

### TECHNICAL SPECIFICATIONS

COLOR	Black
FUNCTION	3 Setting Heated Jacket
HEAT DURATION	Up to 6 Hours
MATERIAL	Shell: 95% Polyester, 5% Spandex Lining: 100% Polyester
WASHING INSTRUCTIONS	Machine Washable, Gentle Cycle
WHAT'S INCLUDED	USB Power Bank & Charging Cable
POWER BANK	5V - 10,000 mAh (TT-109) Power Bank Certification: FCC, CE, RoHS Power Cell Certification: UL Certified
SOLD	Individually
WARRANTY	1 Year

### BODY SIZE GUIDE

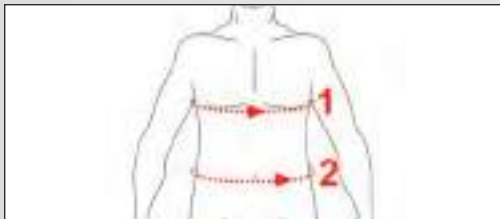

SIZE	M	L	XL	XXL
<b>1</b>	40" - 41"	42" - 43"	44" - 45"	46" - 47"
<b>2</b>	36" - 37"	38" - 39"	40" - 41"	42" - 43"

## GLOVES BLACK - HEATED



**BLACK HEATED GLOVES**  
**TT-107M** Medium  
**TT-107L** Large  
**TT-107XL** XL  
**TT-1072XL** XXL

### TECHNICAL SPECIFICATIONS

COLOR	Black
FUNCTION	3 Setting Heated Gloves
HEAT DURATION	Up to 6 Hours
MATERIAL	Outer Shell: 100% Nylon Hand & Thumb Inserts: 60% Nylon, 40% Polyurethane Lining & Insulation: 100% Polyester
WASHING INSTRUCTIONS	Machine Washable, Gentle Cycle
WHAT'S INCLUDED	2 USB Power Banks & Charging Cable
POWER BANK	5V - 5000 mAh (TT-100) Power Bank Certification: FCC, CE, RoHS Power Cell Certification: UL Certified
SOLD	Individually
WARRANTY	1 Year

### HAND SIZE GUIDE

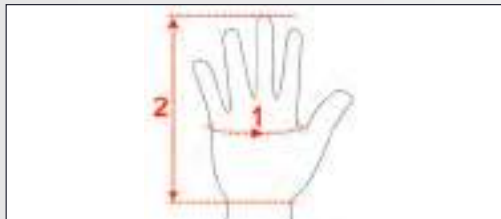

SIZE	M	L	XL	XXL
<b>1</b>	8.1" - 8.5"	8.5" - 8.9"	8.9" - 9.2"	9.2" - 9.7"
<b>2</b>	7.6" - 7.9"	7.9" - 8.2"	8.2" - 8.5"	8.5" - 8.7"

## MITTS BLACK - HEATED



**BLACK HEATED MITTS**  
**TT-108M** Medium  
**TT-108L** Large  
**TT-108XL** XL  
**TT-1082XL** XXL

### TECHNICAL SPECIFICATIONS

COLOR	Black
FUNCTION	3 Setting Heated Mitts
HEAT DURATION	Up to 6 Hours
MATERIAL	Outer Shell: 100% Nylon Hand & Thumb Inserts: 60% Nylon, 40% Polyurethane Lining & Insulation: 100% Polyester
WASHING INSTRUCTIONS	Machine Washable, Gentle Cycle
WHAT'S INCLUDED	2 USB Power Banks & Charging Cable
POWER BANK	5V - 5000 mAh (TT-100) Power Bank Certification: FCC, CE, RoHS Power Cell Certification: UL Certified
SOLD	Individually
WARRANTY	1 Year

### HAND SIZE GUIDE

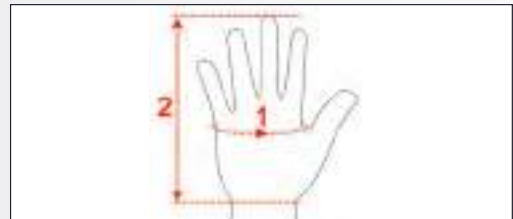

SIZE	M	L	XL	XXL
<b>1</b>	8.1" - 8.5"	8.5" - 8.9"	8.9" - 9.2"	9.2" - 9.7"
<b>2</b>	7.6" - 7.9"	7.9" - 8.2"	8.2" - 8.5"	8.5" - 8.7"

WARNING: Cancer and Reproductive Harm - [www.p65warnings.ca.gov](http://www.p65warnings.ca.gov)

## POWER BANK 10,000 MAH

FOR HEATED  
SOFT SHELL JACKETS  
& BOMBER JACKETS



POWER BANK  
**TT-101** 10,000 mAh

### TECHNICAL SPECIFICATIONS

COLOR	Silver
VOLTAGE	5 Volts
POWER	10,000 mAh
WHAT'S INCLUDED	USB Power Bank & Charging Cable
SOLD	Individually
WARRANTY	1 Year

## POWER BANK 20,000 MAH

FOR HEATED PARKA



POWER BANK  
**TT-102** 20,000 mAh

### TECHNICAL SPECIFICATIONS

COLOR	Black
VOLTAGE	5 Volts
POWER	20,000 mAh
WHAT'S INCLUDED	USB Power Bank & Charging Cable
SOLD	Individually
WARRANTY	1 Year

## POWER BANK 10,000 MAH

FOR HEATED VESTS



POWER BANK  
**TT-109** 10,000 mAh

### TECHNICAL SPECIFICATIONS

COLOR	Silver
VOLTAGE	5 Volts
POWER	10,000 mAh
WHAT'S INCLUDED	USB Power Bank & Charging Cable
SOLD	Individually
WARRANTY	1 Year

## POWER BANK 5000 MAH

FOR HEATED  
MITS & GLOVES



POWER BANK  
**TT-100** 5000 mAh

### TECHNICAL SPECIFICATIONS

COLOR	Black
VOLTAGE	5 Volts
POWER	5000 mAh
WHAT'S INCLUDED	USB Power Bank & Charging Cable
SOLD	Individually
WARRANTY	1 Year

# HEATED GLOVES & MITTS

**PORTABLE RECHARGEABLE  
POWER BANK  
INCLUDED**

**TOUCH SCREEN  
RECEPTIVE  
FINGER TIP PADS**

**MULTIZONE HEATING  
UP TO 6 HOURS OF HEAT**

**WATERPROOF,  
WIND RESISTANT &  
BREATHABLE**

# MERCHANDISING

## UNIVERSAL HEADLIGHT ASSEMBLY COUNTER DISPLAYS



UNIVERSAL LED PROJECTOR HEADLIGHT DISPLAYS  
**TRX-133** Chrome Headlight Assembly  
**TRX-132** Black Headlight Assembly

DISPLAY DIMENSIONS 18" x 10" x 10.5"

### TRX-132 QUALIFYING ORDER

PART NUMBER	DESCRIPTION	UNITS
TLED-H122	Universal LED Projector Headlight Assembly Black (Driver Side)	5
TLED-H123	Universal LED Projector Headlight Assembly Black (Passenger Side)	5

### TRX-133 QUALIFYING ORDER

PART NUMBER	DESCRIPTION	UNITS
TLED-H120	Universal LED Projector Headlight Assembly Chrome (Driver Side)	5
TLED-H121	Universal LED Projector Headlight Assembly Chrome (Passenger Side)	5

## FREIGHTLINER CASCADIA HEADLIGHT ASSEMBLY COUNTER DISPLAY



FREIGHTLINER CASCADIA LED PROJECTOR HEADLIGHT DISPLAY  
**TRX-144** Chrome Headlight Assembly

DISPLAY DIMENSIONS 18" x 15" x 15"

### QUALIFYING ORDER

PART NUMBER	DESCRIPTION	UNITS
TLED-H66	FTL. Cascadia LED Projector Headlight Assembly Chrome (Driver Side)	3
TLED-H67	FTL. Cascadia LED Projector Headlight Assembly Chrome (Passenger Side)	3
TLED-H68	FTL. Cascadia LED Projector Headlight Assembly Black (Driver Side)	2
TLED-H69	FTL. Cascadia LED Projector Headlight Assembly Black (Passenger Side)	2

## RETRO SERIES HEADLIGHT ASSEMBLY COUNTER DISPLAY



RETRO LED PROJECTOR HEADLIGHT DISPLAY  
**TRX-171** Chrome Headlight Assembly

DISPLAY DIMENSIONS 18" x 10" x 10.75"

### QUALIFYING ORDER

PART NUMBER	DESCRIPTION	UNITS
TLED-H104	Retro LED Projector Headlight Assembly-Chrome (Driver Side)	3
TLED-H105	Retro LED Projector Headlight Assembly Chrome (Passenger Side)	3
TLED-H106	Retro LED Projector Headlight Assembly with Mounting Bracket - Chrome (Driver Side)	2
TLED-H107	Retro LED Projector Headlight Assembly with Mounting Bracket - Chrome (Passenger Side)	2

WARNING: Cancer and Reproductive Harm - www.p65warnings.ca.gov

## FREIGHTLINER CENTURY HEADLIGHT ASSEMBLY COUNTER DISPLAY



**FREIGHTLINER CENTURY LED PROJECTOR HEADLIGHT DISPLAY**  
**TRX-143** Chrome Headlight Assembly

DISPLAY DIMENSIONS 25" x 12" x 15"

### QUALIFYING ORDER

PART NUMBER	DESCRIPTION	UNITS
TLED-H49	FTL. Century LED Projector Headlight Assembly Chrome (Driver Side)	2
TLED-H50	FTL. Century LED Projector Headlight Assembly Chrome (Passenger Side)	2
TLED-H57	FTL. Century LED Projector Headlight Assembly Black (Driver Side)	1
TLED-H58	FTL. Century LED Projector Headlight Assembly Black (Passenger Side)	1
TLED-H13	FTL. Century Halogen Headlight Assembly Chrome (Driver Side)	1
TLED-H14	FTL. Century Halogen Headlight Assembly Chrome (Passenger Side)	1
TLED-H15	FTL. Century Halogen Headlight Assembly Black (Driver Side)	1
TLED-H16	FTL. Century Halogen Headlight Assembly Black (Passenger Side)	1

## VOLVO VN/VNL HEADLIGHT ASSEMBLY COUNTER DISPLAY



**VOLVO VN/VNL LED PROJECTOR HEADLIGHT DISPLAY**  
**TRX-131** Chrome Headlight Assembly

DISPLAY DIMENSIONS 21" x 21" x 20"

### QUALIFYING ORDER

PART NUMBER	DESCRIPTION	UNITS
TLED-H17	Volvo VNL LED Projector Headlight Assembly Chrome (Driver Side)	2
TLED-H18	Volvo VNL LED Projector Headlight Assembly Chrome (Passenger Side)	2
TLED-H19	Volvo VNL LED Projector Headlight Assembly Black (Driver Side)	1
TLED-H20	Volvo VNL LED Projector Headlight Assembly Black (Passenger Side)	1
TLED-H45	Volvo VNL Halogen Headlight Assembly Chrome (Driver Side)	1
TLED-H46	Volvo VNL Halogen Headlight Assembly Chrome (Passenger Side)	1
TLED-H54	Volvo VNL Halogen Headlight Assembly Black (Driver Side)	1
TLED-H55	Volvo VNL Halogen Headlight Assembly Black (Passenger Side)	1



# MERCHANDISING

## LED PROJECTOR HEADLIGHTS COUNTER DISPLAY



FRONT

SIDE

4" x 6", 5" x 7", 7" LED PROJECTOR HEADLIGHT DISPLAY  
**TRX-102** Counter Display

DISPLAY DIMENSIONS 18" x 8" x 14.75"

### QUALIFYING ORDER

PART NUMBER	DESCRIPTION	UNITS
TLED-H6	4" x 6" LED Projector Headlight - Low Beam	16
TLED-H7	4" x 6" LED Projector Headlight - High Beam	16
TLED-H4	5" x 7" LED Projector Headlight	8
TLED-H3	7" Round LED Projector Headlight	10

## LED REFLECTOR HEADLIGHTS COUNTER DISPLAY



FRONT

SIDE

4" x 6", 5" x 7", 7" LED REFLECTOR HEADLIGHT DISPLAY  
**TRX-121** Counter Display

DISPLAY DIMENSIONS 18" x 8" x 14.75"

### QUALIFYING ORDER

PART NUMBER	DESCRIPTION	UNITS
TLED-H2	4" x 6" LED Reflector Headlight - Low Beam	16
TLED-H1	4" x 6" LED Reflector Headlight - High Beam	16
TLED-H74	5" x 7" LED Reflector Headlight	8
TLED-H77	7" Round LED Reflector Headlight	10

## 4" x 6" LED PROJECTOR HEADLIGHT COUNTER | SLOTWALL DISPLAY



FRONT

SIDE

4" x 6" LED PROJECTOR HEADLIGHT DISPLAY  
**TRX-089** Counter Display  
**TRX-090** Slotwall Display

DISPLAY DIMENSIONS 13.75" x 8.5" x 8"

### QUALIFYING ORDER

PART NUMBER	DESCRIPTION	UNITS
TLED-H6	4" x 6" LED Projector Headlight - Low Beam	15
TLED-H7	4" x 6" LED Projector Headlight - High Beam	15

## 4" x 6" LED REFLECTOR HEADLIGHT COUNTER DISPLAY



FRONT

SIDE

4" x 6" LED REFLECTOR HEADLIGHT DISPLAY  
**TRX-122** Counter Display

DISPLAY DIMENSIONS 13.75" x 8.5" x 8"

### QUALIFYING ORDER

PART NUMBER	DESCRIPTION	UNITS
TLED-H2	4" x 6" LED Reflector Headlight - Low Beam	15
TLED-H1	4" x 6" LED Reflector Headlight - High Beam	15

WARNING: Cancer and Reproductive Harm - www.p65warnings.ca.gov



 WARNING: Cancer and Reproductive Harm - [www.p65warnings.ca.gov](http://www.p65warnings.ca.gov)

# MERCHANDISING

## STANDARD LED WORK LAMPS COUNTER DISPLAY



STANDARD WORKLAMP DISPLAY  
**TRX-165** Counter Display

DISPLAY DIMENSIONS 26.5" x 6" x 9"

### QUALIFYING ORDER

PART NUMBER	DESCRIPTION	UNITS
TLED-U1	4.5" Round LED Work Lamp - Flood Beam	10
TLED-U9	6" Oval High Powered LED Work Lamp Spot Beam	4
TLED-U5	4.5" Square LED Work Lamp - Spot Beam	8
TLED-U32	3" Mini Square LED Work Lamp - Spot Beam	12
TLED-U34	3" Mini Round LED Work Lamp - Spot Beam	11
TLED-U4	5" Round High Powered LED Work Lamp Spot Beam	8

## STELLAR SERIES MINI LED WORK LAMPS COUNTER DISPLAY



STELLAR MINI DISPLAY  
**TRX-134** Counter Display

DISPLAY DIMENSIONS 15" x 6" x 8"

### QUALIFYING ORDER

PART NUMBER	DESCRIPTION	UNITS
TLED-U87	3" Mini Round "Stellar Series" LED Work Lamp Spot Beam	10
TLED-U88	3" Mini Round "Stellar Series" LED Work Lamp Flood Beam	6
TLED-U89	3" Mini Square "Stellar Series" LED Work Lamp Spot Beam	10
TLED-U90	3" Mini Square "Stellar Series" LED Work Lamp Flood Beam	6
TLED-U93	4" Square "Stellar Series" LED Work Lamp Spot Beam	10
TLED-U95	4.5" Round "Stellar Series" LED Work Lamp Spot Beam	10
TLED-U97	Rectangular "Stellar Series" LED Work Lamp Spot Beam	10
TLED-U98	Rectangular "Stellar Series" LED Work Lamp Flood Beam	4

## STELLAR SERIES LED WORK LAMPS COUNTER DISPLAY



STELLAR SERIES DISPLAY  
**TRX-228** Counter Display

DISPLAY DIMENSIONS 26.5" x 6" x 9"

### QUALIFYING ORDER

PART NUMBER	DESCRIPTION	UNITS
TLED-U88	3" Mini Round "Stellar Series" LED Work Lamp Flood Beam	10
TLED-U90	3" Mini Square "Stellar Series" LED Work Lamp Flood Beam	10
TLED-U94	4" Square "Stellar Series" LED Work Lamp Flood Beam	12
TLED-U96	4.5" Round "Stellar Series" LED Work Lamp Flood Beam	12

WARNING: Cancer and Reproductive Harm - [www.p65warnings.ca.gov](http://www.p65warnings.ca.gov)



# RADIANT SERIES & STROBE LED

## WORK LAMP COUNTER | FLOOR DISPLAY



PREMIUM DISPLAY  
**TRX-169** Floor Display

DISPLAY DIMENSIONS 27.5" x 20" x 70"

### TRX-169 QUALIFYING ORDER

PART NUMBER	DESCRIPTION	UNITS
TLED-U102	4.5" Round Pair "Radiant Series" LED Work Lamp Combination Spot & Flood Beam	15
TLED-U103	4.5" Round Pair "Radiant Series" LED Work Lamp Combination Spot & Flood Beam	15
TLED-U120	4.5" Square "Radiant Series" LED Work Lamp Combination Spot & Flood Beam	10
TLED-U114	4" Round LED Work Lamp Spot Beam with Amber Strobe	5
TLED-U106	4" Cube LED Work Lamp Spot Beam with Amber Strobe	4
TLED-U105	3" Mini Rectangle LED Work Lamp Combination Spot with Flood Beam	4
TLED-W4	6" Rectangle LED Work Lamp - Spot Beam with Amber Strobe	10
TLED-U112	7" Half Moon LED Work Lamp - Flood Beam with Amber Strobe	7
TLED-U108	7" Half Moon LED Work Lamp - Flood Beam	8



COUNTER DISPLAY  
**TRX-170**

DISPLAY DIMENSIONS 25.75" x 11" x 15.75"

**TRX-170 QUALIFYING ORDER**  
CONTACT YOUR TRUX ACCOUNT  
MANAGER TO LEARN HOW TO QUALIFY  
FOR THIS DISPLAY



# MERCHANDISING

## STANDARD LED LIGHTING SLOTWALL DISPLAY



STANDARD LED DISPLAY  
**TRX-094** Slotwall Display

DISPLAY DIMENSIONS 26.75" x 2" x 22.5"

## DUAL LED LIGHTING SLOTWALL DISPLAY



DUAL REVOLUTION LED DISPLAY  
**TRX-130** Slotwall Display

DISPLAY DIMENSIONS 26.75" x 2" x 22.5"

### TRX-094 QUALIFYING ORDER

PART NUMBER	DESCRIPTION	UNITS
TLED-48R	4" LED Red Stop, Turn & Tail Fleet Light	16
TLED-4100R	4" LED Red Stop, Turn & Tail Light	12
TLED-OBMA	Oval Mirror LED Amber Marker Light	12
TLED-OBMR	Oval Mirror LED Red Marker Light	12
TLED-B4A	3/4" Oval LED Amber Marker Light - 3 Wires	12
TLED-B4R	3/4" Oval LED Red Marker Light - 3 Wires	12
TLED-B2A	3/4" Round LED Amber Marker Light - 2 Wires	25
TLED-B2R	3/4" Round LED Red Marker Light - 2 Wires	20
TLED-B2CR	3/4" Round LED Clear Red Marker Light - 2 Wires	20
TLED-B2CA	3/4" Round LED Clear Amber Marker Light - 2 Wires	20
TLED-2R	2" Round Ribbed LED Red Marker Light	20
TLED-2A	2" Round Ribbed LED Amber Marker Light	20
TLED-2TA	2" Round Ribbed LED Clear Amber Marker Light	16
TLED-2TR	2" Round Ribbed LED Clear Red Marker Light	8
TLED-2HA	2.5" Round Ribbed LED Amber Marker Light	12
TLED-2HR	2.5" Round Ribbed LED Red Marker Light	12
TLED-G4A	Generation 4 LED Amber Marker Light	30
TLED-G4R	Generation 4 LED Red Marker Light	6
TLED-G4CA	Generation 4 LED Clear Amber Marker Light	20
TLED-G4CR	Generation 4 LED Clear Red Marker Light	4
TLED-G2A	Generation 2 LED Amber Marker Light	16
TLED-G2R	Generation 2 LED Red Marker Light	16
TLED-INF2A	Small Infinity LED Amber Marker Light	10
TLED-INF2R	Small Infinity LED Red Marker Light	10
TLED-2X6DA	2" x 6" Multi-Directional Trailer LED Amber Marker Light	20
TLED-2X6DR	2" x 6" Multi-Directional Trailer LED Red Marker Light	10
TLED-PETA	Peterbilt LED Amber Marker Light	20
TLED-PETR	Peterbilt LED Red Marker Light	4
TLED-F45A	4.5" Slim Flatline LED Amber Marker Light	6
TLED-F45R	4.5" Slim Flatline LED Red Marker Light	5
TLED-F9A	9" Slim Flatline LED Amber LED Marker Light	6
TLED-F17A	17" Slim Flatline LED Amber Marker Light	6
TLED-F17R	17" Slim Flatline LED Red LED Marker Light	6

### QUALIFYING ORDER

CONTACT YOUR TRUX ACCOUNT  
MANAGER TO LEARN HOW TO QUALIFY  
FOR THIS DISPLAY

 WARNING: Cancer and Reproductive Harm - [www.p65warnings.ca.gov](http://www.p65warnings.ca.gov)

## 3/4" STANDARD & DUAL LED LIGHTING COUNTER | SLOTWALL DISPLAY



### STANDARD & DUAL LED LIGHTING DISPLAY TRX-091 Slotwall | Countertop Display

DISPLAY DIMENSIONS 26" x 5" x 3"

#### QUALIFYING ORDER

PART NUMBER	DESCRIPTION	UNITS
TLED-B3CA	3/4" Round LED Clear Amber Marker Light - 3 Wires	20
TLED-B3R	3/4" Round LED Red Marker Light - 3 Wires	20
TLED-BX3AG	3/4" Round LED Amber Marker to Green Auxiliary Light	20
TLED-BX3RW	3/4" Round Red Marker to White Auxiliary LED Light	20
TLED-BX4AB	3/4" Oval LED Amber Marker to Blue Auxiliary Light - 3 Wires	20
TLED-BX4AW	3/4" Oval LED Amber Marker to White Auxiliary Light - 3 Wires	20
TLED-BX4RW	3/4" Oval LED Red Marker to White Auxiliary Light - 3 Wires	20
TLED-BX4RB	3/4" Oval LED Red Marker to Blue Auxiliary Light - 3 Wires	20

## DUAL REVOLUTION LED LIGHTING COUNTER DISPLAY



FRONT



SIDE

### DUAL LED LIGHTING DISPLAY WITH MOTION SENSOR TRX-078 Countertop Display

DISPLAY DIMENSIONS 16.5" x 11" x 16.25"

#### QUALIFYING ORDER

PART NUMBER	DESCRIPTION	UNITS
TLED-4X40	4" Round Dual Revolution LED Red Stop, Turn & Tail to White Back Up Light - Grommet Mount	20
TLED-4X40F	4" Round Dual Revolution LED Red Stop, Turn & Tail to White Back Up Light - Flange Mount	6
TLED-OX60R	Oval Dual Revolution LED Red Stop, Turn & Tail to White Back Up Light	10
TLED-2XRW	2" Round Dual Revolution LED Red Stop, Turn & Tail to White Back Up Light	5
TLED-G2XRB	Generation 2 Dual Revolution LED Red Marker to Blue Auxiliary Light	12
TLED-G2XAB	Generation 2 Dual Revolution LED Amber Marker to Blue Auxiliary Light	12
TLED-G4XAB	Generation 4 Dual Revolution LED Amber Marker to Blue Auxiliary Light	20
TLED-G4XRB	Generation 4 Dual Revolution LED Red Marker to Blue Auxiliary Light	4
TLED-4XRB	4" Round Dual Revolution LED Red Stop, Turn & Tail to Blue Auxiliary Light	8



# MERCHANDISING

## DUAL REVOLUTION LED COUNTER DISPLAY



FRONT

SIDE

### DUAL REVOLUTION LED DISPLAY TRX-092 Counter Display

DISPLAY DIMENSIONS 13" x 9" x 3"

#### QUALIFYING ORDER

PART NUMBER	DESCRIPTION	UNITS
TLED-4X40	4" Round Dual Revolution LED Red Stop, Turn & Tail to White Back Up Light - Grommet Mount	30
TLED-4X40F	4" Round Dual Revolution LED Red Stop, Turn & Tail to White Back Up Light - Flange Mount	7
TLED-OX60R	Oval Dual Revolution LED Red Stop, Turn & Tail to White Back Up Light	11

## DUAL REVOLUTION LED SMALL SLOTWALL DISPLAY



FRONT

SIDE

### DUAL REVOLUTION LED DISPLAY TRX-093 Slotwall Display

DISPLAY DIMENSIONS 13" x 3.2" x 13"

#### QUALIFYING ORDER

PART NUMBER	DESCRIPTION	UNITS
TLED-4X40	4" Round Dual Revolution LED Red Stop, Turn & Tail to White Back Up Light - Grommet Mount	30
TLED-4X40F	4" Round Dual Revolution LED Red Stop, Turn & Tail to White Back Up Light - Flange Mount	7
TLED-OX60R	Oval Dual Revolution LED Red Stop, Turn & Tail to White Back Up Light	11

## DUAL REVOLUTION LED LARGE SLOTWALL DISPLAY



### DUAL REVOLUTION LED DISPLAY TRX-079 Slotwall Display

DISPLAY DIMENSIONS 26" x 3" x 11"

#### QUALIFYING ORDER

PART NUMBER	DESCRIPTION	UNITS
TLED-4X40	4" Round Dual Revolution LED Red Stop, Turn & Tail to White Back Up Light - Grommet Mount	20
TLED-4X40F	4" Round Dual Revolution LED Red Stop, Turn & Tail to White Back Up Light - Flange Mount	6
TLED-OX60R	Oval Dual Revolution LED Red Stop, Turn & Tail to White Back Up Light	10
TLED-2XRW	2" Round Dual Revolution LED Red Stop, Turn & Tail to White Back Up Light	5
TLED-G2XRB	Generation 2 Dual Revolution LED Red Marker to Blue Auxiliary Light	12
TLED-G2XAB	Generation 2 Dual Revolution LED Amber Marker to Blue Auxiliary Light	12
TLED-G4XAB	Generation 4 Dual Revolution LED Amber Marker to Blue Auxiliary Light	20
TLED-G4XRB	Generation 4 Dual Revolution LED Red Marker to Blue Auxiliary Light	4
TLED-4XRB	4" Round Dual Revolution LED Red Stop, Turn & Tail to Blue Auxiliary Light	8

WARNING: Cancer and Reproductive Harm - www.p65warnings.ca.gov

## DUAL & STROBE LED SMALL COUNTER DISPLAY



FRONT



SIDE

**DUAL REVOLUTION STROBE LED DISPLAY**  
**TRX-187** Counter Display

DISPLAY DIMENSIONS 13" x 7.75" x 12.75"

### QUALIFYING ORDER

PART NUMBER	DESCRIPTION	UNITS
TLED-4X40	4" Round Dual Revolution LED Red Stop, Turn & Tail to White Back Up Light - Grommet Mount	20
TLED-OX60RAS	Oval Dual Revolution LED Red Stop, Turn & Tail to Amber Multi-Pulse Strobe	20

## DUAL & STROBE LED SMALL SLOTWALL DISPLAY



FRONT



SIDE

**DUAL REVOLUTION STROBE LED DISPLAY**  
**TRX-186** Slotwall Display

DISPLAY DIMENSIONS 13" x 3.2" x 13"

### QUALIFYING ORDER

PART NUMBER	DESCRIPTION	UNITS
TLED-4X40	4" Round Dual Revolution LED Red Stop, Turn & Tail to White Back Up Light	20
TLED-OX60RAS	Oval Dual Revolution LED Red Stop, Turn & Tail to Amber Multi-Pulse Strobe	20

## EXHAUST KIT FLOOR DISPLAY



**EXHAUST DISPLAY**  
**TRX-076** Floor Display

DISPLAY DIMENSIONS 30" x 12" x 60"

### QUALIFYING ORDER

**CONTACT YOUR TRUX ACCOUNT  
MANAGER TO LEARN HOW TO QUALIFY  
FOR THIS DISPLAY**

## GLOW STRIP LED COUNTER DISPLAY



FRONT

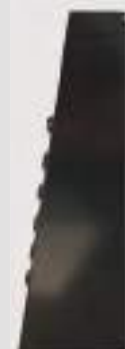

SIDE

**GLOW STRIP LED DISPLAY**  
**TRX-190** Counter Display

DISPLAY DIMENSIONS 18.25" x 5" x 15"

### QUALIFYING ORDER

**CONTACT YOUR TRUX ACCOUNT  
MANAGER TO LEARN HOW TO QUALIFY  
FOR THIS DISPLAY**

# MERCHANDISING

## STARTER STAINLESS FENDER FLOOR DISPLAY



▲  
QUARTER FENDER & MUDFLAP HANGER DISPLAY  
**TRX-168** Starter Program

DISPLAY DIMENSIONS 36" x 24" x 47"

**QUALIFYING ORDER**  
CONTACT YOUR TRUX ACCOUNT  
MANAGER TO LEARN HOW TO QUALIFY  
FOR THIS DISPLAY

## STANDARD STAINLESS FENDER FLOOR DISPLAY



▲  
QUARTER FENDER DISPLAY  
**TRX-167** Standard Program

DISPLAY DIMENSIONS 36" x 24" x 47"

**QUALIFYING ORDER**  
CONTACT YOUR TRUX ACCOUNT  
MANAGER TO LEARN HOW TO QUALIFY  
FOR THIS DISPLAY

## PREMIUM STAINLESS FENDER FLOOR DISPLAY



▲  
STAINLESS QUARTER, HALF & SINGLE AXLE FENDER DISPLAY  
**TRX-113** Premium Program

DISPLAY DIMENSIONS 43" x 48" x 92"

**QUALIFYING ORDER**  
CONTACT YOUR TRUX ACCOUNT  
MANAGER TO LEARN HOW TO QUALIFY  
FOR THIS DISPLAY

## STARTER POLY FENDER FLOOR DISPLAY



▲ QUARTER FENDER DISPLAY  
**TRX-173** Starter Program

DISPLAY DIMENSIONS 36" x 24" x 47"

**QUALIFYING ORDER**  
CONTACT YOUR TRUX ACCOUNT  
MANAGER TO LEARN HOW TO QUALIFY  
FOR THIS DISPLAY

## STANDARD POLY FENDER FLOOR DISPLAY



▲ QUARTER FENDER & SINGLE AXLE DISPLAY  
**TRX-172** Standard Program

DISPLAY DIMENSIONS 36" x 48" x 51"

**QUALIFYING ORDER**  
CONTACT YOUR TRUX ACCOUNT  
MANAGER TO LEARN HOW TO QUALIFY  
FOR THIS DISPLAY

## PREMIUM POLY FENDER FLOOR DISPLAY



▲ POLY QUARTER, HALF & SINGLE AXLE FENDER DISPLAY  
**TRX-112** Premium Program

DISPLAY DIMENSIONS 43" x 48" x 92"

**QUALIFYING ORDER**  
CONTACT YOUR TRUX ACCOUNT  
MANAGER TO LEARN HOW TO QUALIFY  
FOR THIS DISPLAY

# MERCHANDISING



## 3/4" ROUND LED POS DISPLAYS MARKER - BOX OF 80

TRX-140  
BOX CONTAINS  
**80 x TLED-B2A1**



▲  
**AMBER MARKER**  
**TRX-140** Box of 80

TRX-142  
BOX CONTAINS  
**80 x TLED-B2R1**



▲  
**RED MARKER**  
**TRX-142** Box of 80

### TECHNICAL SPECIFICATIONS

DOT/SAE	Compliant
DIODES	3 Diodes
FUNCTION	Marker
CURRENT DRAW	40 mA
LENS MATERIAL	Polycarbonate
SOLD	Box of 80
WARRANTY	3 Years

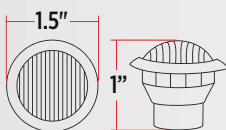

### WIRING

2 BULLET PLUGS



Assemble with any standard  
2 Prong Pigtail.

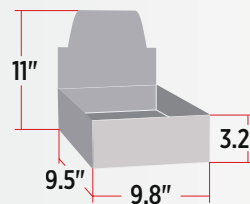

⚠ WARNING: Cancer and Reproductive Harm - [www.p65warnings.ca.gov](http://www.p65warnings.ca.gov)





## 2" ROUND LED POS DISPLAYS MARKER - BOX OF 50

TRX-223  
BOX CONTAINS  
**50 x TLED-2A1**



▲  
**AMBER MARKER**  
**TRX-223** Box of 50



TRX-224  
BOX CONTAINS  
**50 x TLED-2R1**



▲  
**RED MARKER**  
**TRX-224** Box of 50



### TECHNICAL SPECIFICATIONS

DOT/SAE	Compliant
DIODES	9 Diodes
FUNCTION	Marker
CURRENT DRAW	31 mA ~ 39 mA
LENS MATERIAL	Polycarbonate
SOLD	Box of 50
WARRANTY	3 Years

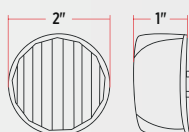

### WIRING

2 PRONG ADAPTER



Assemble with any Double Female Wire Harness.

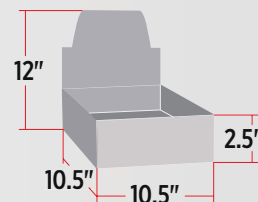

⚠ WARNING: Cancer and Reproductive Harm - [www.p65warnings.ca.gov](http://www.p65warnings.ca.gov)

# MERCHANDISING



## 2.5" ROUND LED POS DISPLAYS MARKER - BOX OF 40

TRX-235  
BOX CONTAINS  
**40 x TLED-2HA1**



▲  
AMBER MARKER  
**TRX-235** Box of 40

TRX-236  
BOX CONTAINS  
**40 x TLED-2HR1**



▲  
RED MARKER  
**TRX-236** Box of 40

### TECHNICAL SPECIFICATIONS

DOT/SAE	Compliant
DIODES	13 Diodes
FUNCTION	Marker
CURRENT DRAW	51 mA ~ 72 mA
LENS MATERIAL	Polycarbonate
SOLD	Box of 40
WARRANTY	3 Years

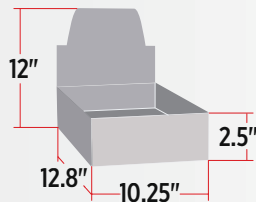
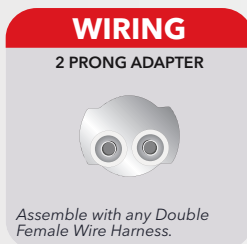
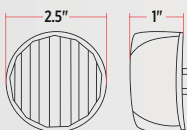

⚠ WARNING: Cancer and Reproductive Harm - [www.p65warnings.ca.gov](http://www.p65warnings.ca.gov)



## GENERATION 4 STANDARD LED POS DISPLAY MARKER - BOX OF 52

TRX-238  
BOX CONTAINS  
**52 x TLED-G4A1**



▲  
AMBER MARKER  
**TRX-238** Box of 52



### TECHNICAL SPECIFICATIONS

DOT/SAE	Compliant
DIODES	4 Diodes
FUNCTION	Marker
CURRENT DRAW	29 mA ~ 30 mA
LENS MATERIAL	Polycarbonate
SOLD	Box of 52
WARRANTY	3 Years

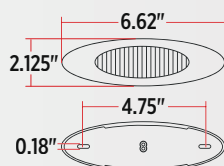

**WIRING**  
2 BULLET PLUGS

● MARKER  
● GROUND

*Assemble with any standard 2 Prong Pigtail.*

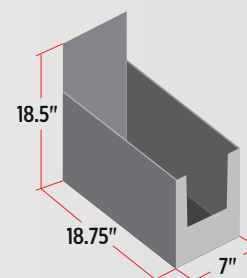

⚠ WARNING: Cancer and Reproductive Harm - [www.p65warnings.ca.gov](http://www.p65warnings.ca.gov)

# MERCHANDISING



## 4" ROUND STANDARD LED POS DISPLAY STOP, TURN & TAIL - BOX OF 48





RED STOP, TURN & TAIL  
TRX-136 Box of 48

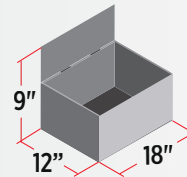
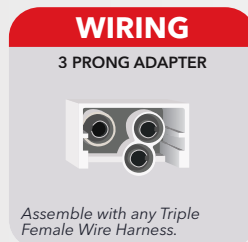
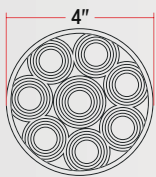

### TECHNICAL SPECIFICATIONS

DOT/SAE	Compliant
DIODES	8 Diodes
FUNCTION	Stop, Turn & Tail
CURRENT DRAW	130 mA
LENS MATERIAL	Polycarbonate
SOLD	Box of 48
WARRANTY	3 Years



 WARNING: Cancer and Reproductive Harm - [www.p65warnings.ca.gov](http://www.p65warnings.ca.gov)



## 4" ROUND DUAL REVOLUTION LED POS DISPLAY

STOP, TURN & TAIL TO WHITE BACK UP - BOX OF 24



### TECHNICAL SPECIFICATIONS

DOT/SAE	Compliant to Auxiliary
DIODES	19 Diodes
FUNCTION 1	Stop, Turn & Tail
FUNCTION 2	Back Up
CURRENT DRAW FUNCTION 1	270 mA
CURRENT DRAW FUNCTION 2	220 mA
LENS MATERIAL	Polycarbonate
SOLD	Box of 24
WARRANTY	3 Years

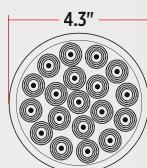

**WIRING**

**3 PRONG & BULLET PLUG**



S, T & T



BACK UP

Assemble with any standard 3 Prong Pigtail and single Female Harness.

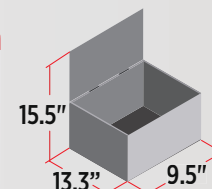

**WARNING:** Cancer and Reproductive Harm - [www.p65warnings.ca.gov](http://www.p65warnings.ca.gov)

# MERCHANDISING



## 2" MINI HIGH POWERED LED WORK LAMP POS DISPLAY SPOT BEAM - BOX OF 30

TRX-135  
BOX CONTAINS  
**30 x TLED-U104**



SPOT BEAM  
**TRX-135** Box of 30



### TECHNICAL SPECIFICATIONS

RAW LUMENS	1500 Lumens
EFFECTIVE LUMENS	900 Lumens
BEAM PATTERN	Spot Beam
DIODES	9 Diodes
OPERATING VOLTAGE	12-24 Volts
LED POWER	18 Watts
CURRENT DRAW (A)	0.87 Amp @ 12 Volts
COLOR TEMPERATURE	6500 Kelvin
HOUSING MATERIAL	Aluminum Die Cast
BRACKET MATERIAL	Stainless Steel
LENS MATERIAL	Polycarbonate
WATERPROOF RATING	IP67 Rating
SOLD	Box of 30
WARRANTY	3 Years

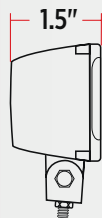
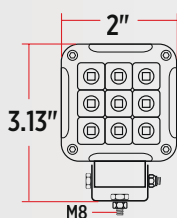

### BEAM PATTERN

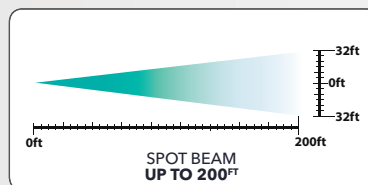

### WIRING

2 WIRE CONNECTION



Connect the negative and positive work lamp wires to the corresponding negative and positive wires from the truck's wiring harness.

**1500**  
LUMENS

**SPOT**  
BEAM

SOLD IN A BOX  
**30 PCS**

**WARNING:** Cancer and Reproductive Harm - [www.p65warnings.ca.gov](http://www.p65warnings.ca.gov)



## 6" RECTANGLE LED WORK LAMP POS DISPLAY

FLOOD BEAM - BOX OF 21

TRX-239  
BOX CONTAINS  
**21 x TLED-U122**



**SPOT BEAM**  
**TRX-239** Box of 21



### TECHNICAL SPECIFICATIONS

RAW LUMENS	1100 Lumens
EFFECTIVE LUMENS	750 Lumens
BEAM PATTERN	Spot Beam
DIODES	12 Diodes
OPERATING VOLTAGE	9-30 Volts
LED POWER	18 Watts
CURRENT DRAW (A)	1.5 Amp @ 12 Volts
COLOR TEMPERATURE	6000 Kelvin
HOUSING MATERIAL	Aluminum Die Cast
BRACKET MATERIAL	Stainless Steel
LENS MATERIAL	Polycarbonate
WATERPROOF RATING	IP67 Rating
SOLD	Box of 21
WARRANTY	3 Years

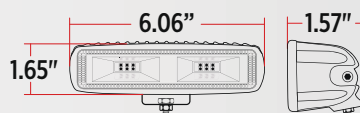

### BEAM PATTERN

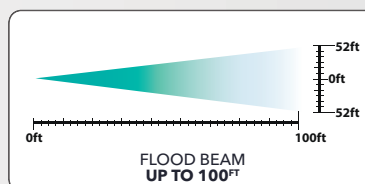

### WIRING

2 WIRE CONNECTION



Connect the negative and positive work lamp wires to the corresponding negative and positive wires from the truck's wiring harness.

**1100**  
LUMENS

**FLOOD**  
BEAM

SOLD IN A BOX  
**21 PCS**

**WARNING:** Cancer and Reproductive Harm - [www.p65warnings.ca.gov](http://www.p65warnings.ca.gov)

# MERCHANDISING



## 4" X 6" HEATED LED PROJECTOR HEADLIGHT POS DISPLAYS HIGH OR LOW BEAM - BOX OF 12 OR 6

TRX-240  
BOX CONTAINS  
**6 x TLED-H11**



**HIGH BEAM**  
**TRX-240** Box of 6

TRX-241  
BOX CONTAINS  
**12 x TLED-H12**



**LOW BEAM**  
**TRX-241** Box of 12

### TECHNICAL SPECIFICATIONS

LED POWER (W)	27 Watts
RAW LUMENS	Low: 1300 Lumens High: 2400 Lumens
EFFECTIVE LUMENS	Low: 850 Lumens High 1150 Lumens
BEAM PATTERN	TLED-H12: Low Beam TLED-H11: High Beam
OPERATING VOLTAGE	9-24 Volts (DRL Compatible)
CURRENT DRAW (A)	2.3 Amps @ 12 Volts
COLOR TEMPERATURE	6000 Kelvin
INTERIOR	Chrome
HOUSING MATERIAL	Aluminum Alloy
LENS MATERIAL	Polycarbonate
WATERPROOF RATING	IP67 Rating
COMPLIANCE	DOT SAE   FMVSS-108   CMVSS-108
SOLD	TRX-240: Box of 6 TRX-241: Box of 12
WARRANTY	7 Years

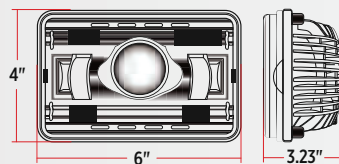

### RETROFIT

LOW BEAM

- 4652
- H4652
- H4656
- H4662

HIGH BEAM

- H4739
- H5062
- H4651
- H5051

### BEAM PATTERNS

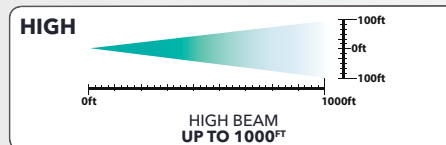
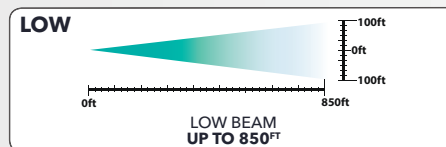

**DOT**  
COMPLIANT

LOW BEAM  
**1300**  
LUMENS

HIGH BEAM  
**2400**  
LUMENS

### WIRING

**HIGH BEAM H4 CONNECTOR**  
(2 Wires)

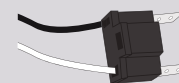

**LOW BEAM H4 CONNECTOR**  
(3 Wires)



Plug & Play

**WARNING:** Cancer and Reproductive Harm - [www.p65warnings.ca.gov](http://www.p65warnings.ca.gov)



# SHOW TRUCK POSTERS

24" WIDE x 18" HIGH



▲ "CODE BLUE" - 2019 SHOW TRUCK  
**TRX-178** Kenworth W900L



▲ "PURPLE HAZE" - 2018 SHOW TRUCK  
**TRX-157** Peterbilt 379



▲ "THE GENERAL" - 2017 SHOW TRUCK  
**TRX-158** Kenworth T660



▲ "MIDNIGHT EXPRESS" - 2016 SHOW TRUCK  
**TRX-159** Volvo VN670



▲ "WICKED" - 2015 SHOW TRUCK  
**TRX-160** Kenworth W900L

**TECHNICAL SPECIFICATIONS**

MATERIAL	Poster Paper
SOLD	Individually

## TRUX CATALOG

VOLUME 11



▲ VOLUME 11  
**TRX-100**

**TECHNICAL SPECIFICATIONS**

SOLD	Individually
------	--------------

## TRUX NATION

MAGAZINE



▲ TRUX NATION  
**TRX-191**

**TECHNICAL SPECIFICATIONS**

SOLD	Individually
------	--------------

# MERCHANDISING

## TRUX USB KEY MARKETING RESOURCES



▲  
16GB  
**TRX-105**

USB INCLUDES	Product Technical Data Website Product Images Product Videos Product Installation Instructions Catalogs & Magazines
--------------	---

## TRUX LOGO SIGN



▲  
CHOROPLAST SIGN  
**TRX-072**

### TECHNICAL SPECIFICATIONS

MATERIAL	Choroplast
SOLD	Individually

## TRUX LOGO SIGN 31" WIDE x 9" HIGH



▲  
HALF MOON  
**TRX-014**

### TECHNICAL SPECIFICATIONS

MATERIAL	Choroplast
SOLD	Individually

## TRUX MINI BATTERY PACK 8 x AA BATTERIES



▲  
FOR AA BATTERIES  
**TRX-054** Batteries NOT Included

### TECHNICAL SPECIFICATIONS

SOLD	Individually
------	--------------

## TRUX BANNER 35" WIDE x 21" HIGH



▲  
GROMMET MOUNT  
**TRX-012**

### TECHNICAL SPECIFICATIONS

MATERIAL	Vinyl with Grommets
SOLD	Individually

## RESTOCK TICKET HANGER STYLE



▲  
5" WIDE x 7" HIGH  
**TRX-209**

### TECHNICAL SPECIFICATIONS

DIMENSIONS	5" x 7"
MATERIAL	Card
SOLD	Individually

▲ WARNING: Cancer and Reproductive Harm - [www.p65warnings.ca.gov](http://www.p65warnings.ca.gov)

# SLOTWALL PANELS

## BLACK SLOTTED WOOD

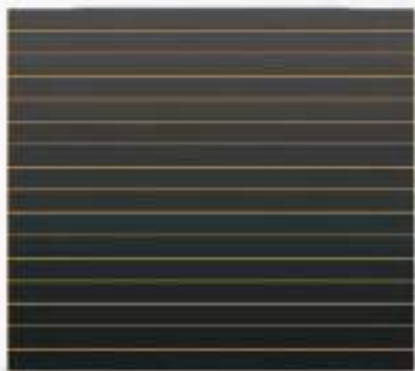

4 FT LONG x 4 FT HIGH  
**TRX-200**

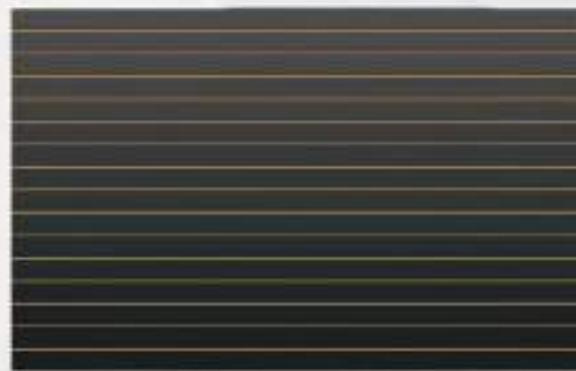

8 FT LONG x 4 FT HIGH  
**TRX-201**

### TECHNICAL SPECIFICATIONS

MATERIAL	Wood
SOLD	Individually

# SLOTWALL PANEL ACCESSORIES

## HOOK | LITERATURE HANGING HOLDER | BRACKET | BASKET



STANDARD SLOTWALL HOOK  
**TRX-202** 4" Long  
**TRX-203** 8" Long  
**TRX-204** 10" Long  
**TRX-205** 12" Long

### TECHNICAL SPECIFICATIONS

SOLD	Individually
------	--------------



KNIFE BRACKET  
**TRX-214** 12" Long

### TECHNICAL SPECIFICATIONS

SOLD	Individually
------	--------------



6 BALL WATERFALL HOOK  
**TRX-206**

### TECHNICAL SPECIFICATIONS

SOLD	Individually
------	--------------



BLACK SHELVES  
**TRX-233** 48" Long x 12" Depth  
**TRX-234** 24" Long x 12" Depth

### TECHNICAL SPECIFICATIONS

MATERIAL	Laminated Melamine
SOLD	Individually



LITERATURE HANGING HOLDER  
**TRX-029** For 8.5" x 11" Brochures

### TECHNICAL SPECIFICATIONS

DIMENSIONS	9" x 1.75" x 10"
MATERIAL	Plastic
SOLD	Individually



BASKET  
**TRX-208** For All Purpose Products

### TECHNICAL SPECIFICATIONS

DIMENSIONS	12" x 12" x 8"
MATERIAL	Black Metal
SOLD	Individually

# MERCHANDISING

## COUNTER MATS 19.5" WIDE x 15.75" HIGH



TRUX LATEST  
**TRX-244**



PROJECTOR LED HEADLIGHT SERIES  
**TRX-245**



UNIVERSAL ACCESSORIES  
**TRX-246**

### TECHNICAL SPECIFICATIONS

SOLD	Individually
------	--------------

## PRODUCT DISPLAY SIGNS 30" WIDE x 8" HIGH | SLOTWALL & MOBILE RETAIL DISPLAYS



STANDARD LED LIGHTING  
**TRX-067**



UNIVERSAL ACCESSORIES  
**TRX-068**



LED WORK LAMPS  
**TRX-071**



DUAL REVOLUTION LED LIGHTING  
**TRX-084**



LED HEADLIGHTS  
**TRX-103**



WHEEL ACCESSORIES  
**TRX-070**

### TECHNICAL SPECIFICATIONS

DIMENSIONS	30" x 0.25" x 8"
MATERIAL	Coroplast
SOLD	Individually

WARNING: Cancer and Reproductive Harm - [www.p65warnings.ca.gov](http://www.p65warnings.ca.gov)

# MOBILE RETAIL DISPLAYS

CUSTOMIZABLE



32" LONG x 32" WIDE x 80" HIGH  
**TRX-063** Custom

## WANT TO SHOWCASE ALL YOUR ACCESSORIES BUT HAVE LIMITED SPACE?

Why not ask your Trux Account Manager to design a completely customized mobile solution that BEST FITS YOUR NEEDS!

Our Mobile Solution only takes 32" x 32" of floor space BUT it provides 60 SQUARE FEET OF PRODUCT!!

Below are just some of the solutions Trux has designed to help grow our customers' business. Call your Trux Account Manager today to get started on your very own customized MRD Display!



EXAMPLE LED LIGHTING DISPLAY



EXAMPLE LED HEADLIGHTS & WORKLAMPS DISPLAY



EXAMPLE WHEEL ACCESSORIES DISPLAY



EXAMPLE MUDFLAP HANGERS DISPLAY

WARNING: Cancer and Reproductive Harm - [www.p65warnings.ca.gov](http://www.p65warnings.ca.gov)

# MERCHANDISING

## GONDOLA DISPLAYS CUSTOMIZABLE



### OPTIMIZE & INCREASE YOUR SALES

Trux Gondolas allow for the versatility to carry many Trux products from displaying accessories on hooks to wire baskets and shelves, the options are endless in displaying our range of accessories.

Increase your sales and optimize your retail space with Trux four-sided free-standing display by creating aisles of product and increasing exposure.

Arriving to your store pre-assembled these Gondola Displays are custom to your requirements. Call your Trux Account Manager today to get started on your very own customized Gondola Display!



 WARNING: Cancer and Reproductive Harm - [www.p65warnings.ca.gov](http://www.p65warnings.ca.gov)

# SLOTWALL DISPLAYS

## CUSTOMIZABLE



**MAXIMIZE ANY WALL OR GONDOLA IN YOUR SHOW ROOM WITH ONE OF OUR CUSTOM DISPLAYS**

### THE PROCESS

We will customize your display from the answers and measurements received from the questionnaire that we have provided. From there Trux will build a product diagram and a suggested order for you to approve.



 WARNING: Cancer and Reproductive Harm - [www.p65warnings.ca.gov](http://www.p65warnings.ca.gov)

# MERCHANDISING

## SLOTWALL DISPLAYS CUSTOMIZABLE



**DEPENDING ON THE SIZE OF  
THE DISPLAY, FREE TRUX  
BANNERS CAN BE ADDED!**

CALL YOUR TRUX ACCOUNT MANAGER  
AT 1-888-950-2227  
FOR MORE INFORMATION.

 WARNING: Cancer and Reproductive Harm - [www.p65warnings.ca.gov](http://www.p65warnings.ca.gov)



# GENERAL POLICY - WARRANTIES

For Owner-Operators, all warranty/return claims must be requested through our authorized Trux Accessories Distributor. Trux Accessories will only process claims from an authorized Trux Distributor. For more information on the warranty/return policy, please contact your Trux Distributor.

## WARRANTY COVERAGE

Trux Accessories reserves the right to request digital pictures or warranties to be returned to Trux for verification. In addition, Trux Accessories is not responsible for any damage caused by accidents, road hazards, non-standard application or misuse. Do not discard warranty items until authorized by a Trux Accessories Representative.

To acquire a Warranty Request Form, please contact our Customer Service Representatives at 1-888-950-2227.

### LED HEADLIGHTS

All LED Headlights have the following warranty coverage from date of purchase:

- Projector LED - 7 Years
- Reflector LED - 5 Years
- Off-Road LED - 1 Year
- LED Headlight Assemblies - 3 Years

(Exception: Freightliner Century & Volvo LED Projector & Halogen Headlight Assemblies have the following warranty coverage - 2 years on LEDs only)

Trux Accessories will replace any LED with one or more burnt-out diode during its guaranteed time period. Warranties do not apply to any LED light that has been installed incorrectly (this includes over-torquing of screws). Condensation is not warranted if all diodes are functioning properly.

### LED LIGHTING & LED WORK LAMPS

- All standard LED Lights & Work Lamps have a 3 Year Warranty from date of purchase.

Trux Accessories will replace any LED with one or more burnt-out diode during its guaranteed time period. Warranties do not apply to any LED light that has been installed incorrectly (this includes over-torquing of screws). Condensation is not warranted if all diodes are functioning properly.

### STAINLESS STEEL & UNIVERSAL ACCESSORIES

- Products are guaranteed against defective workmanship for 1 Year from date of purchase.
- Trux Accessories does not warranty items that have failed due to driver error.
- Trux Accessories does not warranty items that have been modified (including painting the product).
- Trux Accessories does not warranty items that have failed due to improper installation.
- Trux Accessories does not warranty items that have been used in a "non-standard application".

## REDEEMING YOUR WARRANTIES

1. Fill out and fax a copy of the "Product Warranty Request Form" to Trux with pictures of warranty items.
2. For LEDs, batch numbers are required for authentication (this code is found on the back of the light).
3. For Stainless items, Fenders and Stacks, please e-mail required pictures of the item to your Trux Account Manager.
4. If request is approved, we will contact you with a choice of redeeming warranties with replacement parts, or a credit note.

U.S. RMA FORM

CANADA RMA FORM

## WARRANTY REQUEST FORMS

For more information on acquiring RMA forms, contact the Trux Customer Service Representatives at 1-888-950-2227.

# POLICIES

## SHIPPING POLICIES

Proper PO's are required for all orders. If you cannot provide a proper PO, proof of order must be submitted by e-mail or fax.

### FREE SHIPPING

---

#### FOR SMALL PRODUCTS: **\$1000.00 Mixed**

- Lights
- Light Accessories
- Interior Accessories
- Small Exterior Accents

#### PRODUCT CATEGORIES

Product categories are defined between parcel and pallet size shipments.

You can mix any Trux Accessories product of your choice for free shipping as long as the products fall into one of the categories mentioned above. Order will be shipped via UPS.

#### FOR LARGE PRODUCTS: **\$3000.00 Mixed (US) | \$4000.00 Mixed (Canada)**

- Sunvisors
- Exterior Accessories
- Wheel Accessories
- Center Panels
- Mud flap Hangers
- Train Horns

You can mix any Trux Accessories products of your choice for free shipping including all previously mentioned categories of "Free shipping for Small Products". Order will be shipped by pallet via a national carrier.

### DROP SHIPMENTS

---

We are pleased to drop ship your order anywhere within the Continental USA and Canada. Please be aware that additional fees may apply to shipments going to a residential address. Drop shipment orders must be submitted by email or fax. Drop ships must have a valid street address, we cannot ship to post office boxes.



## GENERAL POLICY - RETURNS

Trux Accessories will accept returns of products with valid reason, as determined by your Trux Representative. All returns must be authorized by your Trux Representative before shipment is returned.

### REQUESTING AN RMA #

All RMA requests must be submitted by [FAX \(450-622-2507\)](tel:450-622-2507) or by [EMAIL](mailto:customerservice@truxaccessories.com) to your Trux representative or a member of our Customer Service Team ([customerservice@truxaccessories.com](mailto:customerservice@truxaccessories.com)).

Send a completed copy of the Return of Merchandise Authorization (RMA) form. All returned items must have a RMA number, each box must be labeled with this number. If boxes are not labeled, shipment may be refused at our warehouse location, resulting in a delay in the credit or no credit issued.

### VALID REASON FOR RETURNS

- If product hasn't moved in 6-12 months, Trux Accessories will accept return of products provided that an offsetting order of equal dollar amount is placed. If no offsetting order is placed, a 20% restocking fee will apply.
- If the wrong product was ordered by the distributor - 20% restocking fee.
- If the wrong product was shipped by Trux - No restocking fee.
- If the Distributor receives an over-shipment of product from Trux - No restocking fee.
- If product was received damaged - No restocking fee (provided damages were reported within 48 hours of receipt) - (Proof of damage required with digital images)

### PLEASE NOTE

- For returns of Trux installation items, a 20% restocking fee will apply.
- If customer pricing labels are present on returned products; 35% restocking fee or refusal of return.
- Shipping costs to return items is covered by the customer unless otherwise stated by your Trux Representative or Customer Service Team Member.
- If a product is not returned within 60 days of request - RMA will be considered outstanding and will be closed.

Trux Accessories cannot guarantee a full credit for any item that is returned incomplete or damaged. For all returns, it is the responsibility of the distributor to ship the product back with proper packaging to avoid damages while in transit. Failure to do so risks a partial or zero credit.

Returns are processed in the form of company credit. Company credit is valid for 1 year from issuing date. Trux Accessories does not issue refund checks for returns. Credits will be processed within 30 days of return.

**Trux Accessories reserves the right to decline any return request**  
**\*RMA / WARRANTY policies are subject to change**

# POLICIES

## SHIPPING POLICIES

### MULTIPLE BRANCH SHIPMENTS

---

Want to combine orders from all your company branches to receive free shipping? **We Can Do That!**

1. Send in separate orders with the name of the city/branch clearly marked
2. Each box will be labeled by Trux Accessories accordingly
3. Orders will ship to one main location of your choice
4. Once at your desired location, pallet can be broken down and then shipped to each branch using your internal shipping methods

### DAMAGED SHIPMENTS

---

In the unforeseen event that you receive a shipment from Trux Accessories that looks damaged, please follow these steps for a quick replacement.

1. Sign receipt of shipment as damaged, mark "DAMAGED" on all delivery paperwork
2. Please do not disassemble pallet, take multiple and clear pictures of damages and send via email to Trux Customer Service Representative (customerservice@truxaccessories.com)
3. Contact your Trux Customer Service Representative immediately: 1-888-950-2227
4. Do not discard any items unless authorized by your Trux Customer Service Representative

Failure to notify Trux Accessories of damages within 48 hours of receipt absolves Trux Accessories of any responsibility for replacement or credit.



# LED HEADLIGHTS & ASSEMBLIES

TRUX PART #	UNITED PACIFIC PART #	GROTE PART #	MAXXIMA PART #	JW SPEAKER PART #	PETERSON PART #	TRUCKLITE PART #	OPTRONICS PART #	GRAND GENERAL PART #	DOUBLE JJ ENTERPRISES PART #
<b>TLED-H1</b>	31397	94411-5	VHL-4X6HI MHL-4X6HI MHLE-4X6HI	-	703C	27654C	-	-	-
<b>TLED-H2</b>	31396	94421-5	VHL-4X6LO MHL-4X6LL MHLE-4X6LO	-	702C	27640C	-	-	-
<b>TLED-H3</b>	31496		VHL-07DRL	554961	701C	27270C	HLL93HLS		
<b>TLED-H4</b>	34122	90951-5	VHL-5X7DRL	550071	-	27450C	-	-	-
<b>TLED-H5</b>	34123	-	-	-	-	-	-	-	-
<b>TLED-H6</b>	31274	94421-5	VHL-4X6DRL	551371	-	-	HLL78LS	-	-
<b>TLED-H7</b>	31275	94411-5	-	551381	-	-	HLL79HS	-	-
<b>TLED-H11</b>	-	-	-	551781	-	-	-	-	-
<b>TLED-H12</b>	-	-	-	551771	-	-	-	-	-
<b>TLED-H13</b>	31203	-	-	-	-	-	-	-	-
<b>TLED-H14</b>	31204	-	-	-	-	-	-	-	-
<b>TLED-H15</b>	31205	-	-	-	-	-	-	-	-
<b>TLED-H16</b>	31206	-	-	-	-	-	-	-	-
<b>TLED-H17</b>	31445	-	-	-	-	-	-	-	-
<b>TLED-H18</b>	31446	-	-	-	-	-	-	-	-
<b>TLED-H19</b>	35789	-	-	-	-	-	-	-	-
<b>TLED-H20</b>	35789	-	-	-	-	-	-	-	-
<b>TLED-H45</b>	31263	-	-	-	-	-	-	-	-
<b>TLED-H46</b>	31264	-	-	-	-	-	-	-	-
<b>TLED-H51</b>	31285	-	-	-	-	-	-	-	-
<b>TLED-H52</b>	31297	-	-	-	-	-	-	-	-
<b>TLED-H54</b>	31268	-	-	-	-	-	-	-	-
<b>TLED-H55</b>	31269	-	-	-	-	-	-	-	-
<b>TLED-H71</b>	34124	-	-	-	-	-	-	-	-
<b>TLED-H73</b>	-	-	-	552651	-	-	-	-	-
<b>TLED-H74</b>	-	90951-5	VHL-5X7HILO MHL-5X7HILO	-	-	-	-	-	-
<b>TLED-H75</b>	-	-	-	552671	-	-	-	-	-
<b>TLED-H77</b>	-	90941-5	VHL-07HILO MHL-07HILO	-	-	-	-	-	-
<b>TLED-H120</b>	31154	-	-	-	-	-	-	-	-
<b>TLED-H121</b>	31155	-	-	-	-	-	-	-	-
<b>TLED-H122</b>	31156	-	-	-	-	-	-	-	-
<b>TLED-H123</b>	31157	-	-	-	-	-	-	-	-
<b>TU-1045</b>	30438								80432

# TRUX INTERCHANGE

## LED WORK LAMPS

TRUX PART #	UNITED PACIFIC PART #	GROTE PART #	MAXXIMA PART #	JW SPEAKER PART #	PETERSON PART #	TRUCKLITE PART #	OPTRONICS PART #	GRAND GENERAL PART #	DOUBLE JJ ENTERPRISES PART #
TLED-U1	39688	-	MWL-01B MWL-28 MWL-41	-	-	81240	-	76350 80417	-
TLED-U2		-	MWL-27	-	-	-	-	-	-
TLED-U4	36617	-	MWL-01HP	-	-	-	-	-	-
TLED-U5	37553	-	-	-	-	-	-	-	-
TLED-U6	37088	-	-	-	-	-	-	-	-
TLED-U8	-	63J01	MWL-24SP	-	-	-	-	-	-
TLED-U9	-	63J01	-	-	-	-	-	-	-
TLED-U16	37561B	-	M42347	-	-	-	-	-	-
TLED-U17		-	M63347						
TLED-U18	36854	63F61 63F71	-	-	-	-	-	-	-
TLED-U20	-	-	MWL-04 MWL-26-A	-	-	-	-	-	-
TLED-U22	36508	63621 63611	MWL-05SP MWL-07SP MWL-29 MWL-39 MWL-42 MWL-50SP MWL-57SP MWL-58	-	-	-	-	-	-
TLED-U25	-	-	MWL-01HP MWL-19-A	-	-	-	-	-	-
TLED-U26	-	-	MWL-27-A MWL-30 MWL-40	-	-	-	-	-	-
TLED-U27	37622	62L81 63F71	MWL-16 MWL-43	-	-	-	-	-	-
TLED-U29		63F91 63J11	MWL-25SP	-	-	-	-	76364	-
TLED-U32	37622		MWL-20 MWL-20FB	-	-	-	-	-	-
TLED-U33	37157	64H01-5	MWL-20 MWL-20FB	-	-	8192	-	-	-
TLED-U34	37074	64G41 64G61	-	-	-	-	-	-	-
TLED-U35	-	64G51 64G71	-	-	-	-	-	-	-
TLED-U36	-	BZ301-5	PLB-640	-	-	-	-	-	-
TLED-U40	-	63601	MWL-05SP	-	-	-	-	-	-
TLED-U47	-	63821 63831	MWL-12	-	-	-	-	-	-
TLED-U66	-	64J21	-	-	-	-	-	-	-
TLED-U67	-	64J31	-	-	-	-	-	-	-

CONTINUED ON NEXT PAGE

TRUX PART #	UNITED PACIFIC PART #	GROTE PART #	MAXXIMA PART #	JW SPEAKER PART #	PETERSON PART #	TRUCKLITE PART #	OPTRONICS PART #	GRAND GENERAL PART #	DOUBLE JJ ENTERPRISES PART #
<b>TLED-U86</b>	36641	-	-	-	-	-	-	-	-
<b>TLED-U87</b>	-	64G01 64S51	-	-	-	-	-	-	-
<b>TLED-U88</b>	-	64G11 64S61 BZ111-5	-	-	-	-	-	-	-
<b>TLED-U90</b>	-	BZ601-5	-	-	-	-	-	-	-
<b>TLED-U93</b>	37598	63981	-	-	-	-	-	-	-
<b>TLED-U94</b>	37597	63991 BZ201-5	-	-	-	-	-	-	-
<b>TLED-U96</b>	-	BZ101-5	MWL-11HL	-	-	-	-	-	-
<b>TLED-U98</b>	-	BZ301-5	-	-	-	-	-	-	-

## LED LIGHTING & ACCESSORIES

TRUX PART #	UNITED PACIFIC PART #	GROTE PART #	MAXXIMA PART #	TRUCKLITE PART #	OPTRONICS PART #	GRAND GENERAL PART #	ROADMASTER PART #
<b>B608</b>	-	-	M50950A-200	-	-	-	1990
<b>B611</b>	-	-	M50950A-100	-	-	-	1991
<b>B612</b>	34243	-	M50900 -100	-	-	-	1992
<b>D612</b>	34197	-	M50960-100 M50960-50	-	-	-	-
<b>TB-C7W</b>	39930	60261 60691 G6151	-	-	-	-	-
<b>TB-F2A</b>	-	L105116037	-	-	-	-	-
<b>TB-F2B</b>	-	L105116047	-	-	-	-	-
<b>TB-F2G</b>	-	L105116057	-	-	-	-	-
<b>TB-F2R</b>	-	L105116027	-	-	-	-	-
<b>TB-F2W</b>	-	L105116017	-	-	-	-	-
<b>TB-S1156A</b>	-	94793-4	-	-	-	-	-
<b>TB-S1156W</b>	-	94791-4 94801-5	-	-	-	-	-
<b>TB-S1157R</b>	-	94812-4	-	-	-	-	-
<b>TB-S1157W</b>	-	94811-4 94821-5	-	-	-	-	-
<b>TB-SP3037A</b>	37800 38272	94753-4	-	-	-	-	-
<b>TB-SP3037B</b>	38273 37801	-	-	-	-	-	-
<b>TB-SP3037G</b>	38274	-	-	-	-	-	-
<b>TB-SP3037R</b>	37802 38276	94752-4	-	-	-	-	-
<b>TB-SP3037W</b>	37803 38277	94761-5	-	-	-	-	-

CONTINUED ON NEXT PAGE

# TRUX INTERCHANGE

## LED LIGHTING & ACCESSORIES

TRUX PART #	UNITED PACIFIC PART #	GROTE PART #	MAXXIMA PART #	TRUCKLITE PART #	OPTRONICS PART #	GRAND GENERAL PART #	ROADMASTER PART #
TB-SP3156W	-	94831-4 94841-5	-	-	-	-	-
TB-SP3157A	-	94853-4 94860-5	-	-	-	-	-
TB-SP3157R	-	94852-4	-	-	-	-	-
TB-SP3157W	-	94851-4 94860-5 94861-5	-	-	-	-	-
TBEZ-2CH3	10458 20501	-	M50305	-	-	80729	-
TBEZ-2CH4	33996	-	-	-	-	-	-
TBEZ-2HCH2	-	-	-	-	-	80726	802PV
TBEZ-2HCH3	20503	-	M50105	-	-	-	-
TBEZ-4CH3	10484 10500 20504	-	M50405	-	-	-	-
TBEZ-4CH4	33998	-	-	-	-	-	-
TBEZ-4LR	-	43253	M43253 M50410	-	-	87143	-
TBEZ-OBCH3	20506	-	M50146 M50605	-	-	-	-
TBEZ-OBCH4	-	-	M63253CH	-	-	-	-
TBEZ-OLR	-	43723	-	-	-	87146	-
TBEZ-SQR	10485	-	M49705	-	-	-	808PV
TGRO-2HR	-	92070	M50102	10702	-	-	-
TGRO-2HRO	-	91400 91410	M50100-B	-	-	-	1817-2
TGRO-2R	-	92120 GRM4320B-PG	M50300-B	-	-	80722	1817
TGRO-2RC	-	92150 GRM4300B-PG	-	-	-	-	-
TGRO-4R	-	91740	M50400-B	-	-	80473	1913-2
TGRO-4RC	-	91950	-	-	-	-	-
TGRO-OBR	-	92420 GRM4310B-PG	M50600-B M50607	-	-	80802	1917-2
TGRO-OBRC	-	92720	M50606-X	-	-	-	-
TGRO-SQR	-	-	M49700	-	-	-	1921-2
TLED-1X2A	-	47083 G1503 MKR4700Y-PG	M20320Y	-	-	-	1831A
TLED-1X2R	-	47082 G1502 MKR4700R-PG	M20320R	-	-	-	1831R
TLED-1X4A	-	47093 47493 G1903 MKR4710Y-PG	M20350Y	-	-	-	1829A
TLED-1X4R	-	46742 47092 47492 G1902 MKR4710R-PG	M20350R	-	-	-	1829R

CONTINUED ON NEXT PAGE



TRUX PART #	UNITED PACIFIC PART #	GROTE PART #	MAXXIMA PART #	TRUCKLITE PART #	OPTRONICS PART #	GRAND GENERAL PART #	ROADMASTER PART #
<b>TLED-2A</b>	38170	47113 G3003	M09100Y	10385Y 3050-A	MCL50ABP	79280	1815-1A
<b>TLED-2BA</b>	-	47213 G3093	M09105Y M34600Y	-	-	-	1821-1A
<b>TLED-2BR</b>	-	47212 G3092	M09105R M34600R	-	-	-	1821-1R
<b>TLED-2HA</b>	-	45833-3 47123 G1033 G1093	M11300Y	10275Y	-	-	1824-1A
<b>TLED-2HBA</b>	-	47223 G1083	M11201Y M16800Y	-	-	-	1825-1A
<b>TLED-2HBR</b>	-	47222 G1082	M11201R M16800R	-	-	-	1825-1R
<b>TLED-2HR</b>	38177	45832-3 47122 G1032 G1092	M11300R M16280R	-	-	-	1824-1R
<b>TLED-2HTA</b>	-	G1043	M11300YCL	1051A	-	-	1824-2AC
<b>TLED-2HTR</b>	-	G1042	M11300RCL	1051	-	-	1824-2RC
<b>TLED-2HXCA</b>	-	-	-	1051A	-	-	-
<b>TLED-2HXCR</b>	-	-	-	1051	-	-	-
<b>TLED-2R</b>		45822 47112 G3002	M09100R	-	-	-	1815-1R
<b>TLED-2TA</b>	38362	-	M09100YCL	-	-	-	1815-2AC
<b>TLED-2TR</b>		-	M09100RCL	-	-	-	1815-2RC
<b>TLED-2X6A</b>	38256	-	M20395Y	21275Y		77664	1840-1A
<b>TLED-2X6R</b>	38257	-	M20395R				1840-1R
<b>TLED-2X6RA</b>	-	46073 46833 47073 47163 47733 G2103	M20330Y M20391Y	-	-	-	1842A
<b>TLED-2X6RR</b>	-	47072 47162 47732 G2102	M20330R M20391R	-	-	-	1842R
<b>TLED-2X6SA</b>	38578	-	M63120Y	-	-	-	-
<b>TLED-2X6SCA</b>	38579	-		-	-	-	-
<b>TLED-2XCA</b>	-	-	M34260YCL	-	-	-	-
<b>TLED-2XCR</b>	-	-	M34260RCL	-	-	-	-
<b>TLED-4100A</b>	-	53253 53413 53553 54313 54333 54343 54363 54643 G4003	M42100Y	-	-	76450	-
<b>TLED-4100R</b>	39821	-	-	44253R 4050	STL55RBP	76457 76452	-
<b>TLED-4100W</b>	36680 38065	62101 62271 62391 62691	M42324	4060C	-	76454	1916-1W

CONTINUED ON NEXT PAGE

# TRUX INTERCHANGE

## LED LIGHTING & ACCESSORIES

TRUX PART #	UNITED PACIFIC PART #	GROTE PART #	MAXXIMA PART #	TRUCKLITE PART #	OPTRONICS PART #	GRAND GENERAL PART #	ROADMASTER PART #
<b>TLED-419CR</b>	38782 39643 39701	G4022	-	4051	STL513RCBP	76458	-
<b>TLED-419R</b>	-	-	-	4050	-	-	-
<b>TLED-430R</b>	-	54562 G4002 53312	M42320R	4050	-	78273	-
<b>TLED-48CR</b>	-	-	M42322RCL	-	-	-	1907-2RC
<b>TLED-48R</b>	38098	52922-3 53552-3 54332 54362 53252-3	M42322R M42346R M42365R	44302R	STL13RBP	77452 77456	-
<b>TLED-48RG</b>	38098	-	-	-	-	-	-
<b>TLED-48RT</b>	-	-	M42344R	44302R	-	-	-
<b>TLED-4X40</b>	36530	55162	M85416R	-	-	-	-
<b>TLED-4X40F</b>	-	55202	M85417R	-	-	-	-
<b>TLED-4XRB</b>	36529	-	-	-	-	-	-
<b>TLED-B1A</b>	-	-	M09320Y M09410Y	-	-	-	-
<b>TLED-4X40F</b>	-	55202	M85417R	-	-	-	-
<b>TLED-4XRB</b>	36529	-	-	-	-	-	-
<b>TLED-B1A</b>	-	-	M09320Y M09410Y	-	-	-	-
<b>TLED-B1R</b>	-	-	M09320R M09410R	-	-	-	-
<b>TLED-B2A</b>	37142	49323 49333	M09300Y M09400Y	33050Y	-	-	-
<b>TLED-B2CA</b>	37144	-	M09300YCL M09400YCL	-	-	-	-
<b>TLED-B2CR</b>	-	-	M09300RCL M09400RCL	-	-	-	-
<b>TLED-B2R</b>	-	49332 49322	M09300R M09400R	33050R 33265R	-	-	-
<b>TLED-B3A</b>	37967	49363	M09300YAT	-	-	-	-
<b>TLED-B3CA</b>	37969	-	-	-	-	-	-
<b>TLED-B3R</b>	-	49362	M09300RAS	-	-	-	-
<b>TLED-B4A</b>	-	47963 49383	-	-	-	-	-
<b>TLED-B4R</b>	-	47962 49382	-	-	-	-	-
<b>TLED-BA</b>	-	G4603	M23015Y	-	-	-	-
<b>TLED-BA</b>	-	G4603	M23015Y	-	-	-	-
<b>TLED-BR</b>	-	46792 G4602	M23015R	-	-	-	1826-2R
<b>TLED-BX3AB</b>	36840	-	-	-	-	-	-
<b>TLED-BX3RB</b>	36842	-	-	-	-	-	-
<b>TLED-CAB</b>	39527 39971	-	M27011Y	-	-	77568	1950A-L

CONTINUED ON NEXT PAGE

TRUX PART #	UNITED PACIFIC PART #	GROTE PART #	MAXXIMA PART #	TRUCKLITE PART #	OPTRONICS PART #	GRAND GENERAL PART #	ROADMASTER PART #
TLED-CAB2	39529 39996	-	M27011YCL	-	-	-	1950A
TLED-CABC	39528 39972	-	-	-	-	-	1950AC-L
TLED-CABC2	39530 39997	-	-	-	-	-	1950AC
TLED-DFF	38103 39438	G5300	M42341R/Y	-	-	-	-
TLED-F17A	-	-	M20343Y	-	-	-	-
TLED-F17CA	-	-	M20343YCL	-	-	-	-
TLED-F17CR	-	-	M20343RCL	-	-	-	-
TLED-F17R	-	-	M20343R	-	-	-	-
TLED-FLCA	38448	-	-	-	-	-	-
TLED-FLCAC	38449	-	-	-	-	-	-
TLED-FTLA	39486	47063	M20321Y M20361Y	-	-	-	1952A
TLED-FTLCA	39487	-	M20361YCL	-	-	-	-
TLED-FX78	-	-	M63318-A M63318R-A	-	-	-	-
TLED-G2A	-	45773 47953	M36180Y	-	-	79250	-
TLED-G2CA	-	47983	M36180YCL	-	-	79251	-
TLED-G2CR	-	47982	M36180RCL	-	-	-	-
TLED-G2R	-	45772 47952	M36180R	-	-	79255	-
TLED-G4A	36988	45583	M72270Y	00212355P	-	79460	-
TLED-G4CA	36990	-	M72270YCL	00212356P	-	79462	-
TLED-G4CR	-	-	M72270RCL	-	-	-	-
TLED-G4R	-	45582	M72270R	-	-	-	-
TLED-G4XCA	-	47772	-	-	-	-	-
TLED-G4XCR	-	47773	-	-	-	-	-
TLED-HOBA	38920	52193 54183 54193	M61321Y M63121Y	-	-	-	1925A
TLED-INF2A	-	47913	-	-	-	-	1814-1A
TLED-INF2CA	-	47923	-	-	-	-	-
TLED-INF2CR	-	47922	-	-	-	-	-
TLED-INF2R	-	47912	-	-	-	-	1814-1R
TLED-INFA	36988	-	M27005Y M20344 CH-Y	-	-	77830	1810-1A
TLED-INFCA	-	-	M27005YCL M20344 CH-YCL	-	-	77831	-
TLED-INFCR	-	-	M27005RCL M20344CH-RCL	-	-	-	-
TLED-INFR	-	-	M27005R M20344-RCL	-	-	77832	1810-1R
TLED-O12CR	38122	-	-	-	-	-	-
TLED-OBMA	39341	52183 53963 54133 54143 TUR5000Y-PG G6003	M63322Y M63420Y	6050A	-	87720	1919-1A

CONTINUED ON NEXT PAGE

# TRUX INTERCHANGE

## LED LIGHTING & ACCESSORIES

TRUX PART #	UNITED PACIFIC PART #	GROTE PART #	MAXXIMA PART #	TRUCKLITE PART #	OPTRONICS PART #	GRAND GENERAL PART #	ROADMASTER PART #
<b>TLED-OBMCA</b>	39342	-	M63322YCL	-	-	-	1919-2AC
<b>TLED-OBMCR</b>	-	-	M63322RCL	-	-	-	1919-2RC
<b>TLED-OBMR</b>	38121	52182 53962 54132 54142 54762 54722 54752 STT5000R-PG	M63322R M63346R M63420R	6058 6050	STL572RBP	77442 77053 87721	1919-1R
<b>TLED-OBMW</b>	-	62231 62601 62751	M63324 M63347	6060C	-	-	-
<b>TLED-OX60R</b>	-	54702 54627 54682	M85615R M85616R M63354-HYB	-	-	-	-
<b>TLED-PA</b>	-	-	M63122Y	-	-	-	-
<b>TLED-PCAB</b>	38152 38312 38313	-	-	-	-	-	1951A0L
<b>TLED-PCAB2</b>	38511 38517 39406 39823 39962 39964	45993	-	-	-	-	1951A
<b>TLED-PCABC</b>	38153 38461 38462	-	-	-	-	-	1951AC-L
<b>TLED-PCABC2</b>	38512 38518 39824 39963 39965	-	-	-	-	-	1951AC
<b>TLED-PETA</b>	38134	47253	M20332Y M30332Y	2673A	-	78565	1806-2A
<b>TLED-PETCA</b>	-	-	M20332YCL	-	-	-	1806-2AC
<b>TLED-PETR</b>	-	47252	M20332R M30332R	-	-	-	1806-2R
<b>TLED-PSH</b>	38396 38548 39436	-	-	-	-	-	-
<b>TLED-PSHC</b>	38397 38549 39437	-	-	-	-	-	-
<b>TLED-SDXC</b>	38758 38759 39379 39380	G5530 G5540	M42362RYCL-A M42363RYCL-A	-	-	-	-
<b>TPIG-2W</b>	-	67001-3 67050-3 PGT6710N-PG	M50950	94924	-	81010	-
<b>TPIG-3W</b>	-	67000-3 67090 PGT6700N-PG	M50900 M50911	-	-	80472 80783	-

CONTINUED ON NEXT PAGE

TRUX PART #	UNITED PACIFIC PART #	GROTE PART #	MAXXIMA PART #	TRUCKLITE PART #	OPTRONICS PART #	GRAND GENERAL PART #	ROADMASTER PART #
<b>TPIG-L1</b>	-	-	-	94706	-	-	-
<b>TPIG-L2</b>	-	-	M50904	-	-	-	-
<b>TU-1005</b>	-	-	M50905	-	-	-	-
<b>TU-1007</b>	-	-	PF-240	-	-	-	-
<b>TU-1029</b>	32352	-	-	-	-	-	-
<b>TU-1029A</b>	32346 32351	-	-	-	-	-	-
<b>TU-1039</b>	34205	-	M50914 M50915	-	-	-	-

## UNIVERSAL ACCESSORIES

TRUX PART #	UNITED PACIFIC PART #	AMERICAN CHROME PART #	GRAND GENERAL PART #	ROADMASTER PART #	ROADWORKS PART #	FLEETLINE PART #	BETTS HD PART #	FLEET ENGINEERS PART #
<b>THORN-1</b>	46150 46151	23451	69988 69991	5020	-	-	-	-
<b>THORN-2</b>	46123 46130 46152	-	-	-	-	-	-	-
<b>THORN-SV</b>	-	-	69993	-	-	-	-	-
<b>THUB-4N</b>	-	16110 16112	10513	203	-	-	-	-
<b>THUB-4NP</b>	10146 20146	-	-	203-2	-	-	-	-
<b>THUB-4NSS</b>	20118	17023	-	203S	-	-	-	-
<b>THUB-5N</b>	-	-	10514	204	-	-	-	-
<b>THUB-5NP</b>	20147	-	-	-	-	-	-	-
<b>THUB-5NSS</b>	20094	-	-	204S	-	-	-	-
<b>THUB-6N</b>	10167	16252	10660	205	-	-	-	-
<b>THUB-6NP</b>	-	-	10700	-	-	-	-	-
<b>THUB-6NSS</b>	-	16253	10760	205S	-	-	-	-
<b>THUB-834</b>	-	16932 16930	20030	-	-	-	-	-
<b>THUB-834P</b>	10229 20190	16943	-	-	-	-	-	-
<b>THUB-834SS</b>	-	16933	-	-	-	-	-	-
<b>THUB-858</b>	10202C	-	20020	310	-	-	-	-
<b>THUB-858P</b>	10228	-	20130	310-2	-	-	-	-
<b>THUB-858SS</b>	20202	-	-	310SCD-2 310S	-	-	-	-
<b>THUB-C1</b>	10305	-	-	-	-	-	-	-
<b>THUB-C4</b>	10308	-	-	-	-	-	-	-
<b>THUB-FRP112</b>	-	15000	-	-	-	-	-	-
<b>THUB-FRP33</b>	10257	15100 15200	40134	217P	-	-	-	-
<b>THUB-FRP33B</b>	-	15105	-	-	-	-	-	-

CONTINUED ON NEXT PAGE

# TRUX INTERCHANGE

## UNIVERSAL ACCESSORIES

TRUX PART #	UNITED PACIFIC PART #	AMERICAN CHROME PART #	GRAND GENERAL PART #	ROADMASTER PART #	ROADWORKS PART #	FLEETLINE PART #	BETTS HD PART #	FLEET ENGINEERS PART #
<b>THUB-RP33P</b>	10278	-	-	-	-	-	-	-
<b>THUB-RPN</b>	-	15700	-	-	-	-	-	-
<b>TM-2002</b>	-	19061	33080 33081	4080S	-	-	-	-
<b>TM-2003</b>	-	19071	33250	4081S	-	-	-	-
<b>TM-2004</b>	-	19210	33323	4220S	-	-	-	-
<b>TM-2007</b>	86501B	-	-	-	-	-	-	-
<b>TM-2008</b>	-	-	33310	4115S	-	-	-	-
<b>TM-2009</b>	-	-	33101 33370	4125S	-	-	-	-
<b>TM-2011</b>	-	19101	-	4120S	-	-	-	-
<b>TNUT-B2</b>	10047	18013 18012 18010 18002	10011 10016 10039	-	-	-	-	-
<b>TNUT-C1</b>	10075	17801	-	111-60	-	-	-	-
<b>TNUT-F1</b>	-	17800 17802	10037 10265 10266	-	-	-	-	-
<b>TNUT-F1SS</b>	10081P	17803 17807	10272	-	-	-	-	-
<b>TNUT-F2</b>	10049B 10075	18200 18202 18210 18212 18300 18302	10276	111	-	-	-	-
<b>TNUT-F2L</b>	10117 10568	-	10258 10268	-	-	-	-	-
<b>TNUT-F2T</b>	10064B	18100 18102	-	111PFL	-	-	-	-
<b>TNUT-F2TL</b>	10034B	18350	10261	-	-	-	-	-
<b>TNUT-P1</b>	10569B	-	10264	-	-	-	-	-
<b>TU-1030</b>	-	23640	-	3005	-	-	-	-
<b>TU-1031</b>	10451	22170	30518	640	-	-	-	-
<b>TU-1032</b>	-	22171	-	640S	-	-	-	-
<b>TU-1033</b>	-	18400 18410	90252	100	-	-	-	-
<b>TU-1037</b>	-	15990	-	217P-T	-	-	-	-
<b>TU-1714</b>	-	20101	-	-	-	-	-	-
<b>TU-1715</b>	-	20101	-	-	-	-	-	-
<b>TU-1716</b>	21552	20103 20101	-	-	-	-	-	-
<b>TU-9001L</b>	34664	-	-	473S-3	0604B-02	-	-	-
<b>TU-9001LC</b>	34665	-	-	473S-4	-	-	-	-
<b>TU-9008</b>	-	21371	-	478S	-	-	-	-
<b>TU-9204</b>	-	14493	-	615S	-	-	-	-
<b>TU-9209</b>	-	21851	30171 30170	480S-SL	-	-	-	-

CONTINUED ON NEXT PAGE

TRUX PART #	UNITED PACIFIC PART #	AMERICAN CHROME PART #	GRAND GENERAL PART #	ROADMASTER PART #	ROADWORKS PART #	FLEETLINE PART #	BETTS HD PART #	FLEET ENGINEERS PART #
TU-9209L1	61726 62726	-	-	481S-SL-3	-	-	-	-
TU-9210	22301	-	-	-	-	-	-	-
TU-9210L1	62730	-	-	-	-	-	-	-
TU-9210LC	62731	-	-	-	-	-	-	-
TU-9214	10841 11310	21963 21961	30574	646S-SL	-	FF30SS-KIT	B703000NTSK	033-04993
TU-9215	10843	-	-	-	-	-	-	-
TU-9221	-	21990	30560	648-SL	-	-	-	-
TU-9222	-	22012	-	648B-SL	-	-	-	-
TU-9223	-	21991	30575	648S-SL	-	-	-	-
TU-9228	-	21992 22002	-	-	-	-	-	-
TU-9229	-	22001	-	647S-SL	-	-	-	-
TU-9232	10653	21965	30573	646-SL	-	-	B703000NTCK	-
TU-9233	-	21969 21962	-	646B-SL	-	-	-	-
TU-9242	-	14490	-	-	-	-	-	-
TU-9246	21409P 10416P	14513	30048	616SCD	10422	-	-	-
TU-9249	-	21900	-	-	-	-	-	-



**PURPLE HAZE**  
2018 TRUX SHOW TRUCK

CONTINUED ON NEXT PAGE

# TRUX INTERCHANGE

## FENDERS

TRUX PART #	BETTS HD PART #	HOEGBUILT PART #	UNITED PACIFIC PART #	FLEETLINE PART #	MINIMIZER PART #	MERRITT PART #	FLEET ENGINEERS PART #	NULINE PART #	ROADMASTER PART #
TFEN-A12	-	MQ2012	10629	-	-	-	-	-	-
TFEN-A15	X2900	-	-	-	-	-	-	-	-
TFEN-A19	400118-01	-	-	-	-	-	-	-	-
TFEN-A29	B900S	-	-	-	-	-	-	-	-
TFEN-A30	B900S	-	-	-	-	-	-	-	-
TFEN-F10	-	5556	-	-	-	-	-	-	-
TFEN-F11	TS43905439	5506	-	3845-132	-	-	-	-	-
TFEN-F12	TS43905439	-	-	3445-132	-	5043-2	-	-	-
TFEN-F13	TS43505431	-	-	-	-	-	-	-	-
TFEN-F21	SR400-120	-	-	-	-	-	-	-	-
TFEN-F26	PF400-132X	-	-	5345-131	MIN900B	5343-2	-	-	-
TFEN-F40	-	-	-	-	MIN200	-	-	-	-
TFEN-FKIT	U400TS	-	-	4400-X	-	-	-	-	-
TFEN-FKITP2	K4362PS	-	-	4455-X	B4578BTSA	-	-	-	-
TFEN-H12	5040-2	-	-	3725-60	MA300-66	5040	034-02240	-	-
TFEN-H13	TS33503100	-	-	3725-66	-	-	-	-	-
TFEN-H20	-	BA500HT	-	3825-66	-	-	-	-	-
TFEN-H21	TSB3902700	-	-	-	-	-	-	-	-
TFEN-H32	SR300-60	-	-	-	-	-	-	N60SS	-
TFEN-H34	SR300-66	-	-	-	-	-	-	N66SS	-
TFEN-H35	GK33503100	-	-	-	-	-	-	-	-
TFEN-H37	SR300-80	-	-	-	-	-	-	N80SS	-
TFEN-H38	GR300-80	-	-	-	-	-	-	-	-
TFEN-H39	PF300-66	-	-	5325-66	MIN950	5340-2	-	-	-
TFEN-H50	-	BA505HT	-	-	-	-	-	-	-
TFEN-H52	-	BA510HT	-	-	-	-	-	-	-
TFEN-H53	-	BA510HT	-	-	-	-	-	-	-
TFEN-H57	-	BA510HT	-	-	-	-	-	-	-
TFEN-HKIT	U300TS	-	-	4200-X	-	-	-	-	-
TFEN-HKITP2	K3362PS	-	-	4255-X	B4850BTSA	-	-	-	-
TFEN-Q10	ST211PA2	M124	10808	1585PM24-KIT	-	-	031-00419	-	745S
TFEN-Q11	-	M127	10809	1585PM27-KIT	-	-	-	-	-
TFEN-Q12	-	-	10810	-	-	-	-	-	-
TFEN-Q13	-	M134	10624	1585PM35-KIT	-	-	-	-	-
TFEN-Q14	-	M130	10855	-	-	-	-	-	-
TFEN-Q17	SS211PA2	-	10585 10636	1585B-KIT	-	5070-2	031-01070	-	742S
TFEN-Q20	PS211PP2	-	10711	1900-KIT	MIN1400	5060-2	031-01636	-	-
TFEN-Q25	-	-	-	1585ELM-KIT	-	-	031-01074	-	-
TFEN-Q28	SS221PA2	-	-	1585ELMB-KIT	-	-	-	-	-
TFEN-S12	-	2706	-	3805-80	-	-	-	NF180SSNR	-
TFEN-S13	TS28000000	-	-	3705-80	-	5044-2	034-02241	-	-
TFEN-S17	PF200-80	-	-	5005-76	MIN2480B	5433-2	-	NF180PX	-

CONTINUED ON NEXT PAGE



TRUX PART #	BETTS HD PART #	HOEGBUILT PART #	UNITED PACIFIC PART #	FLEETLINE PART #	MINIMIZER PART #	MERRITT PART #	FLEET ENGINEERS PART #	NULINE PART #	ROADMASTER PART #
<b>TFEN-S22</b>	SR200-80	-	-	-	-	-	-	N180SS	-
<b>TFEN-S37</b>	-	2756 2710	-	-	-	-	-	-	-
<b>TFEN-SKIT</b>	L200TS	-	-	4000	-	-	-	-	-
<b>TFEN-SKITP2</b>	K2362PS	-	-	4055	B100B TSA	-	-	-	-



**CODE BLUE**  
2019 TRUX SHOW TRUCK

# TRUX INDEX

TRUX PART #	PAGE #	TRUX PART #	PAGE #	TRUX PART #	PAGE #	TRUX PART #	PAGE #	TRUX PART #	PAGE #
B607	118	TBEZ-2HCH4	113	TF-1104	276	TFEN-A64	179	TFEN-H63	165
B608	118	TBEZ-2HCH5	113	TF-1105	273	TFEN-F10	167	TFEN-H66	176
B609	118	TBEZ-4CH2	113	TF-1106	275	TFEN-F11	166	TFEN-HKIT	171
B610	118	TBEZ-4CH3	113	TF-1108	273	TFEN-F12	166	TFEN-HKIT2	171
B611	118	TBEZ-4CH4	113	TF-1109	271	TFEN-F13	167	TFEN-HKIT2HD	171
B612	118	TBEZ-4CH5	113	TF-1111	276	TFEN-F14	166	TFEN-HKITN	171
D604	117	TBEZ-4LR	114	TF-1203	276	TFEN-F15	168	TFEN-HKITP	177
D606	117	TBEZ-OBCH2	114	TF-1208	275	TFEN-F17	168	TFEN-HKITP2	177
D608	117	TBEZ-OBCH3	114	TF-1209	273	TFEN-F21	168	TFEN-HKITP3	177
D610	117	TBEZ-OBCH4	114	TF-1210	273	TFEN-F26	176	TFEN-Q10	156
D612	117	TBEZ-OBCH5	114	TF-1211	274	TFEN-F33	167	TFEN-Q11	157
S608	117	TBEZ-OLR	114	TF-1212	273	TFEN-F34	166	TFEN-Q12	158
S610	117	TBEZ-SQR	115	TF-1401	276	TFEN-F37	168	TFEN-Q13	157
S612	117	TCLA-103	197	TF-1405	270	TFEN-F40	176	TFEN-Q14	157
T604	118	TCLA-51	197	TF-1409	271	TFEN-F41	167	TFEN-Q17	155
T606	118	TCLA-61	197	TF-1410	271	TFEN-FKIT	171	TFEN-Q20	175
T608	118	TCLA-63	197	TF-1412	272	TFEN-FKIT2	171	TFEN-Q21	158
T610	118	TCLA-83	197	TF-1413	272	TFEN-FKIT2HD	171	TFEN-Q25	156
T612	118	TCLA-PEB	197	TF-1414	272	TFEN-FKITHD	171	TFEN-Q26	156
TB-C7W	112	TCLA-PEBA	197	TF-1422	274	TFEN-FKITN	171	TFEN-Q28	156
TB-F2A	110	TCLA73	197	TF-1427	274	TFEN-FKITP	178	TFEN-S10	170
TB-F2B	110	TEL-10	193	TF-1429	270	TFEN-FKITP2	178	TFEN-S11	169
TB-F2G	110	TEL-105	193	TF-1430	270	TFEN-FKITP3	178	TFEN-S12	169
TB-F2R	110	TEL-65	193	TF-1437	272	TFEN-H10	162	TFEN-S13	169
TB-F2W	110	TEL-75	193	TF-1454	271	TFEN-H11	162	TFEN-S14	170
TB-FCLIP	110	TEL-8	193	TF-1455	272	TFEN-H12	159	TFEN-S16	170
TB-FKIT	110	TEL-85	193	TF-1601	276	TFEN-H13	160	TFEN-S17	176
TB-S1156A	111	TEL55-PET	194	TF-1608	274	TFEN-H14	161	TFEN-S22	170
TB-S1156R	111	TEL65-PET	194	TF-1706	275	TFEN-H15	160	TFEN-S32	169
TB-S1156W	111	TEL75-PET	194	TFEN-A10	173	TFEN-H16	161	TFEN-S33	169
TB-S1157A	111	TEL85-PET	194	TFEN-A11	173	TFEN-H20	160	TFEN-S37	170
TB-S1157R	111	TF-1003	276	TFEN-A12	173	TFEN-H21	160	TFEN-SKIT	172
TB-S1157W	111	TF-1010	270	TFEN-A13	173	TFEN-H24	164	TFEN-SKITHD	172
TB-SP3037A	112	TF-1011	270	TFEN-A15	174	TFEN-H27	164	TFEN-SKITN	172
TB-SP3037B	112	TF-1015	269	TFEN-A17	174	TFEN-H29	164	TFEN-SKITP	177
TB-SP3037G	112	TF-1016	269	TFEN-A19	174	TFEN-H31	164	TFEN-SKITP2	178
TB-SP3037R	112	TF-1016LM	269	TFEN-A29	173	TFEN-H32	163	TFT-FLCAS	271
TB-SP3037W	112	TF-1016LMC	269	TFEN-A29	179	TFEN-H34	163	TFT-FLCAS3	271
TB-SP3156A	111	TF-1017	269	TFEN-A30	173	TFEN-H35	163	TFT-FLCOL	275
TB-SP3156R	111	TF-1018	269	TFEN-A30	179	TFEN-H37	163	TFT-KWT660	256
TB-SP3156W	111	TF-1018LM	269	TFEN-A36	174	TFEN-H38	163	TFT-KWT680	252
TB-SP3157A	111	TF-1018LMC	269	TFEN-A38	174	TFEN-H39	175	TFT-KWT680N	252
TB-SP3157R	111	TF-1019	269	TFEN-A44	174	TFEN-H50	161	TFT-MVIS	287
TB-SP3157W	111	TF-1020	269	TFEN-A53	180	TFEN-H52	162	TFT-PET379	229
TBEZ-2CH2	113	TF-1020LM	269	TFEN-A54	173	TFEN-H53	162	TFT-PET379F	229
TBEZ-2CH3	113	TF-1020LMC	269	TFEN-A54	179	TFEN-H54	160	TFT-PET389	231
TBEZ-2CH4	113	TF-1024	269	TFEN-A55	180	TFEN-H55	159	TFT-PET579	232
TBEZ-2CH5	113	TF-1025	269	TFEN-A58	173	TFEN-H57	162	TFT-VN	278
TBEZ-2HCH2	113	TF-1025LM	269	TFEN-A58	179	TFEN-H59	159	TGRO-2HR	115
TBEZ-2HCH3	113	TF-1025LMC	269	TFEN-A63	179	TFEN-H61	159	TGRO-2HRO	115

TRUX PART #	PAGE #	TRUX PART #	PAGE #	TRUX PART #	PAGE #	TRUX PART #	PAGE #	TRUX PART #	PAGE #
TGRO-2R	115	THORN-2	141	TK-1002	257	TK-1113	259	TK-13111LM	246
TGRO-2RC	115	THORN-D	141	TK-1003	257	TK-1114	259	TK-13111LMC	246
TGRO-4R	115	THORN-SV	141	TK-1032	242	TK-1115	260	TK-13112	246
TGRO-4RC	115	THUB-4N	131	TK-1033	242	TK-1119	250	TK-13112L	246
TGRO-OBR	115	THUB-4NP	131	TK-1034	242	TK-1121	250	TK-13112LC	246
TGRO-OBRC	115	THUB-4NSS	131	TK-1034LM	242	TK-1127	245	TK-13114	247
TGRO-SQR	115	THUB-5N	131	TK-1034LMC	242	TK-1133	252	TK-1318	247
THOD-FLCAS	267	THUB-5NP	131	TK-1035	242	TK-1134	262	TK-1368	247
THOD-FLCAS2	267	THUB-5NSS	131	TK-1035LM	242	TK-1140	260	TK-1368LM	247
THOD-FLCC	267	THUB-6N	131	TK-1035LMC	242	TK-1141	262	TK-1368LMC	247
THOD-FLCC2	267	THUB-6NP	131	TK-1037	243	TK-1143	252	TK-1370	247
THOD-FLCL	268	THUB-6NSS	131	TK-1038	243	TK-1144	252	TK-1370LM	247
THOD-FLCOL	267	THUB-712	132	TK-1038L	243	TK-1201	258	TK-1370LMC	247
THOD-FLCOR	268	THUB-834	132	TK-1038LC	243	TK-1202	258	TK-1377	246
THOD-FLCOR2	268	THUB-834P	132	TK-1055	242	TK-1203	258	TK-1377LM	246
THOD-FLD120	268	THUB-834SS	132	TK-1056	242	TK-1204	258	TK-1377LMC	246
THOD-IN40	282	THUB-834SS2003	132	TK-1057	242	TK-1205	260	TK-1387	246
THOD-IN92	283	THUB-858	132	TK-1057LM	242	TK-1206	260	TK-1387LM	246
THOD-IN93	283	THUB-858P	132	TK-1057LMC	242	TK-1208	261	TK-1387LMC	246
THOD-IN94	283	THUB-858SS	132	TK-1058	242	TK-1209	261	TK-1401	249
THOD-IN99	283	THUB-C1	119	TK-1058L	242	TK-1210	261	TK-1402	249
THOD-INLS	282	THUB-C2	121	TK-1058LMC	242	TK-1211	256	TK-1406	262
THOD-INPR	282	THUB-C3	121	TK-1074	242	TK-1214	261	TK-1407	250
THOD-KW70	240	THUB-C4	119	TK-1074L	242	TK-1219	249	TK-1409	259
THOD-KW880	239	THUB-C5	122	TK-1074LC	242	TK-1224	260	TK-1419	259
THOD-KW900B	238	THUB-C6	122	TK-1086	242	TK-1225	260	TK-1427	254
THOD-KW900L	238	THUB-C7	120	TK-1086L	242	TK-1226	253	TK-1428	254
THOD-KWT2000	239	THUB-FRP	124	TK-1086LC	242	TK-1228	262	TK-1430	249
THOD-KWT300	240	THUB-FRP112	124	TK-1087	242	TK-1229	262	TK-1431	249
THOD-KWT600	239	THUB-FRP33	123	TK-1088	242	TK-1232	262	TK-1436	256
THOD-KWT660	239	THUB-FRP33B	124	TK-1088LM	242	TK-13100	241	TK-1438	254
THOD-KWT680	238	THUB-FRP33P	125	TK-1088LMC	242	TK-13101	241	TK-1451	253
THOD-KWT800	238	THUB-FRP33PO	123	TK-1089	242	TK-13101LM	241	TK-1501	246
THOD-MCH	286	THUB-FRPN	124	TK-1089L	242	TK-13101LMC	241	TK-1501	248
THOD-MGCT	286	THUB-FRPNP	125	TK-1089LC	242	TK-13102	241	TK-1502	246
THOD-PET335	203	THUB-RP	127	TK-1090	242	TK-13103	241	TK-1502	248
THOD-PET379	202	THUB-RP112	127	TK-1091	242	TK-13103L	241	TK-1502LM	246
THOD-PET386	202	THUB-RP33	126	TK-1091LM	242	TK-13103LC	241	TK-1502LM	248
THOD-PET387	204	THUB-RP33B	127	TK-1091LMC	242	TK-13104	241	TK-1502LMC	246
THOD-PET389	203	THUB-RP33P	128	TK-1092	242	TK-13105	241	TK-1502LMC	248
THOD-PET3K	202	THUB-RP33PO	126	TK-1092L	242	TK-13106	241	TK-1503	246
THOD-PET567	203	THUB-RPN	127	TK-1092LC	242	TK-13106LM	241	TK-1503	248
THOD-PET579	204	THUB-RPNP	128	TK-1093	243	TK-13106LMC	241	TK-1504	246
THOD-PET587	204	TI-1103	284	TK-1093L	243	TK-13107	241	TK-1504	248
THOD-VN	277	TI-1104	284	TK-1093LC	243	TK-13107L	241	TK-1504LM	246
THOD-WC	290	TI-1301	284	TK-1105	257	TK-13107LC	241	TK-1504LM	248
THOD-WCF	290	TI-1411	284	TK-1106	245	TK-13108	246	TK-1504LMC	246
THOD-WH	290	TI-1703	284	TK-1107	259	TK-13109	246	TK-1504LMC	248
THOD-WSB	290	TI-1708	284	TK-1110	258	TK-13110	246	TK-1513	246
THORN-1	141	TK-0108	261	TK-1111	257	TK-13111	246	TK-1513	248

# TRUX INDEX

TRUX PART #	PAGE #	TRUX PART #	PAGE #	TRUX PART #	PAGE #	TRUX PART #	PAGE #	TRUX PART #	PAGE #
TK-1514	246	TK-1634	251	TLED-2HBA	86	TLED-419R	77	TLED-BX1AG	63
TK-1514	248	TK-1649	255	TLED-2HBR	86	TLED-419RF	78	TLED-BX1AP	63
TK-1514LM	246	TK-1651	253	TLED-2HR	85	TLED-430R	78	TLED-BX1AR	63
TK-1514LM	248	TK-1670	253	TLED-2HR1	311	TLED-48A	75	TLED-BX1AW	63
TK-1514LMC	246	TK-1671	253	TLED-2HTA	85	TLED-48CR	75	TLED-BX1RB	63
TK-1514LMC	248	TK-1672	253	TLED-2HTR	85	TLED-48R	75	TLED-BX1RG	63
TK-1515	246	TK-1680	254	TLED-2HXAB	66	TLED-48R1	313	TLED-BX1RP	63
TK-1515	248	TK-1681	254	TLED-2HXAG	66	TLED-48RG	75	TLED-BX1RW	63
TK-1565	246	TK-1682	242	TLED-2HXAP	66	TLED-48RT	75	TLED-BX3AB	62
TK-1565	248	TK-1682LM	242	TLED-2HXCA	86	TLED-4X40	55	TLED-BX3AG	62
TK-1565L	246	TK-1682LMC	242	TLED-2HXCR	86	TLED-4X401	314	TLED-BX3AP	62
TK-1565L	248	TK-1702	257	TLED-2HXRB	66	TLED-4X40A	59	TLED-BX3AR	62
TK-1565LC	246	TK-1704	256	TLED-2HXRG	66	TLED-4X40AS	54	TLED-BX3AW	62
TK-1565LC	248	TK-1712	254	TLED-2HXRP	66	TLED-4X40F	55	TLED-BX3RB	62
TK-1566	246	TK-1814	244	TLED-2HXRW	66	TLED-4X40G	55	TLED-BX3RG	62
TK-1566	248	TK-1814LM	244	TLED-2R	83	TLED-4X40T	55	TLED-BX3RP	62
TK-1566L	246	TK-1814LMC	244	TLED-2R1	310	TLED-4X40W	59	TLED-BX3RW	62
TK-1566L	248	TK-1815	244	TLED-2TA	83	TLED-4XAB	59	TLED-BX40	56
TK-1566LC	246	TK-1815LM	244	TLED-2TR	83	TLED-4XAG	59	TLED-BX4AB	64
TK-1566LC	248	TK-1815LMC	244	TLED-2X6A	95	TLED-4XRB	59	TLED-BX4AR	64
TK-1578	246	TK-1844	244	TLED-2X6AB	71	TLED-4XRBF	60	TLED-BX4AW	64
TK-1578	248	TK-1844LM	244	TLED-2X6CA	95	TLED-4XRG	59	TLED-BX4RB	64
TK-1578L	246	TK-1844LMC	244	TLED-2X6CR	95	TLED-4XRGF	60	TLED-BX4RW	64
TK-1578L	248	TK-1845	244	TLED-2X6DA	95	TLED-4XRP	59	TLED-CAB	92
TK-1578LC	246	TK-1845LM	244	TLED-2X6DCA	95	TLED-4XRPF	60	TLED-CAB2	92
TK-1578LC	248	TK-1845LMC	244	TLED-2X6DCR	95	TLED-B1A	82	TLED-CAB2XAB	70
TK-1579	246	TK-1848	244	TLED-2X6DR	95	TLED-B1CA	82	TLED-CAB2XAG	70
TK-1579	248	TK-1848L	244	TLED-2X6R	95	TLED-B1CR	82	TLED-CAB2XAP	70
TK-1579LM	246	TK-1848LC	244	TLED-2X6RA	94	TLED-B1R	82	TLED-CABC	92
TK-1579LM	248	TK-1852	244	TLED-2X6RB	71	TLED-B2A	81	TLED-CABC2	92
TK-1579LMC	246	TK-1852L	244	TLED-2X6RR	94	TLED-B2A1	309	TLED-DFC2	103
TK-1579LMC	248	TK-1852LC	244	TLED-2X6SA	94	TLED-B2CA	81	TLED-DFC3	104
TK-1580	246	TK-1853	244	TLED-2X6SCA	94	TLED-B2CR	81	TLED-DFCC2	103
TK-1580	248	TK-1853L	244	TLED-2XA	84	TLED-B2R	81	TLED-DFCC3	104
TK-1580L	246	TK-1853LC	244	TLED-2XAB	65	TLED-B2R1	309	TLED-DFF	103
TK-1580L	248	TK-1858	244	TLED-2XAG	65	TLED-B3A	81	TLED-DFO	104
TK-1580LC	246	TK-1858L	244	TLED-2XAP	65	TLED-B3CA	81	TLED-DFXB	73
TK-1580LC	248	TK-1858LC	244	TLED-2XAR	65	TLED-B3CR	81	TLED-DFXG	73
TK-1600	261	TK-1901	258	TLED-2XCA	84	TLED-B3R	81	TLED-DFXP	73
TK-1601	261	TLED-012A	79	TLED-2XCR	84	TLED-B4A	80	TLED-F17A	101
TK-1602	255	TLED-1X2A	94	TLED-2XR	84	TLED-B4CA	80	TLED-F17CA	101
TK-1603	255	TLED-1X2R	94	TLED-2XRB	65	TLED-B4CR	80	TLED-F17CR	101
TK-1609	250	TLED-1X4A	94	TLED-2XRG	65	TLED-B4R	80	TLED-F17R	101
TK-1616	251	TLED-1X4R	94	TLED-2XRP	65	TLED-B5A	81	TLED-F17W	101
TK-1617	251	TLED-2A	83	TLED-2XRW	65	TLED-B5CA	81	TLED-F2A	84
TK-1618	251	TLED-2A1	310	TLED-4100A	77	TLED-B5CR	81	TLED-F2CA	84
TK-1620	255	TLED-2BA	86	TLED-4100R	77	TLED-B5R	81	TLED-F2CR	84
TK-1621	255	TLED-2BR	86	TLED-4100W	77	TLED-BA	96	TLED-F2R	84
TK-1630	251	TLED-2HA	85	TLED-419CR	77	TLED-BR	96	TLED-F45A	102
TK-1631	251	TLED-2HA1	311	TLED-419CRF	78	TLED-BX1AB	63	TLED-F45CA	102

TRUX PART #	PAGE #	TRUX PART #	PAGE #	TRUX PART #	PAGE #	TRUX PART #	PAGE #	TRUX PART #	PAGE #
TLED-F45R	102	TLED-G2XCA	89	TLED-GL48CP	109	TLED-H63	18	TLED-PETR	97
TLED-F4CR	79	TLED-G2XCR	89	TLED-GL48CR	109	TLED-H66	05	TLED-PSH	97
TLED-F4R	79	TLED-G2XR	89	TLED-GL48CW	109	TLED-H67	05	TLED-PSHC	97
TLED-F4R1	79	TLED-G2XRB	68	TLED-GL48SA	109	TLED-H68	05	TLED-PSHXB	71
TLED-F4RCR1	79	TLED-G2XRG	68	TLED-GL48SB	109	TLED-H69	05	TLED-PSHXG	71
TLED-F9A	101	TLED-G2XRP	68	TLED-GL48SG	109	TLED-H7	14	TLED-PSHXP	71
TLED-F9CA	101	TLED-G2XRW	68	TLED-GL48SP	109	TLED-H70	21	TLED-SA	110
TLED-F9R	101	TLED-G4A	87	TLED-GL48SR	109	TLED-H71	17	TLED-SDX	105
TLED-FD	104	TLED-G4A1	312	TLED-GL48SW	109	TLED-H73	14	TLED-SDXB	74
TLED-FDC	104	TLED-G4CA	87	TLED-H1	15	TLED-H74	19	TLED-SDXC	105
TLED-FG2A	90	TLED-G4CR	87	TLED-H104	03	TLED-H75	14	TLED-SDXG	74
TLED-FG2CA	90	TLED-G4R	87	TLED-H105	03	TLED-H77	21	TLED-SDXP	74
TLED-FG2CR	90	TLED-G4XA	89	TLED-H106	03	TLED-HOBA	96	TLED-SOBA	96
TLED-FG2R	90	TLED-G4XAB	67	TLED-H107	03	TLED-INF2A	93	TLED-SR	110
TLED-FG3A	98	TLED-G4XAG	67	TLED-H11	11	TLED-INF2CA	93	TLED-SXAB	72
TLED-FG3CA	98	TLED-G4XAP	67	TLED-H11	317	TLED-INF2CR	93	TLED-SXAG	72
TLED-FG3CR	98	TLED-G4XAW	67	TLED-H12	11	TLED-INF2R	93	TLED-SXAP	72
TLED-FG3R	98	TLED-G4XCA	89	TLED-H12	317	TLED-INF2A	93	TLED-SXAR	72
TLED-FG4A	102	TLED-G4XCR	89	TLED-H120	01	TLED-INFCA	93	TLED-SXRB	72
TLED-FG4CA	102	TLED-G4XR	89	TLED-H121	01	TLED-INF2CA	93	TLED-SXRG	72
TLED-FG4CR	102	TLED-G4XRB	67	TLED-H122	01	TLED-INF2CR	93	TLED-SXRP	72
TLED-FG4R	102	TLED-G4XRG	67	TLED-H123	01	TLED-O12CA	79	TLED-TLA	96
TLED-FGA	90	TLED-G4XRP	67	TLED-H13	07	TLED-O12CR	79	TLED-TLR	96
TLED-FGCA	90	TLED-GL12CA	107	TLED-H14	07	TLED-O12R	79	TLED-U1	37
TLED-FGCR	90	TLED-GL12CB	107	TLED-H15	07	TLED-OBMA	80	TLED-U10	41
TLED-FGR	90	TLED-GL12CG	107	TLED-H16	07	TLED-OBMCA	80	TLED-U102	26
TLED-FLA1	49	TLED-GL12CP	107	TLED-H17	09	TLED-OBMCR	80	TLED-U103	26
TLED-FLA1X	49	TLED-GL12CR	107	TLED-H18	09	TLED-OBMR	80	TLED-U104	31
TLED-FLCA	99	TLED-GL12CW	107	TLED-H19	09	TLED-OBMW	80	TLED-U104	315
TLED-FLCAC	99	TLED-GL12SA	107	TLED-H2	15	TLED-OX60A	61	TLED-U105	32
TLED-FPA	99	TLED-GL12SB	107	TLED-H20	09	TLED-OX60AS	54	TLED-U106	30
TLED-FPCA	99	TLED-GL12SG	107	TLED-H3	21	TLED-OX60R	56	TLED-U107	30
TLED-FS	105	TLED-GL12SP	107	TLED-H39	05	TLED-OX60RAS	54	TLED-U108	43
TLED-FSC	105	TLED-GL12SR	107	TLED-H4	19	TLED-OXAB	61	TLED-U112	28
TLED-FTLA	99	TLED-GL12SW	107	TLED-H42	05	TLED-OXAG	61	TLED-U114	28
TLED-FTLCA	99	TLED-GL24CA	108	TLED-H43	05	TLED-OXAP	61	TLED-U116	25
TLED-FX106	71	TLED-GL24CB	108	TLED-H44	05	TLED-OXAR	61	TLED-U118	27
TLED-FX72	57	TLED-GL24CG	108	TLED-H45	09	TLED-OXRB	61	TLED-U120	24
TLED-FX73	57	TLED-GL24CP	108	TLED-H46	09	TLED-OXRG	61	TLED-U122	31
TLED-FX76	57	TLED-GL24CR	108	TLED-H49	07	TLED-OXRP	61	TLED-U122	316
TLED-FX78	57	TLED-GL24CW	108	TLED-H5	17	TLED-PA	99	TLED-U16	44
TLED-G2A	88	TLED-GL24SA	108	TLED-H50	07	TLED-PCAB	92	TLED-U17	44
TLED-G2CA	88	TLED-GL24SB	108	TLED-H51	22	TLED-PCAB2	92	TLED-U18	35
TLED-G2CR	88	TLED-GL24SG	108	TLED-H52	20	TLED-PCAB2XAB	70	TLED-U19	38
TLED-G2R	88	TLED-GL24SP	108	TLED-H54	09	TLED-PCAB2XAG	70	TLED-U2	34
TLED-G2XA	89	TLED-GL24SR	108	TLED-H55	09	TLED-PCAB2XAP	70	TLED-U20	42
TLED-G2XAB	68	TLED-GL24SW	108	TLED-H56	18	TLED-PCABC	92	TLED-U21	42
TLED-G2XAG	68	TLED-GL48CA	109	TLED-H57	07	TLED-PCABC2	92	TLED-U22	42
TLED-G2XAP	68	TLED-GL48CB	109	TLED-H58	07	TLED-PETA	97	TLED-U25	38
TLED-G2XAW	68	TLED-GL48CG	109	TLED-H6	14	TLED-PETCA	97	TLED-U26	35

# TRUX INDEX

TRUX PART #	PAGE #	TRUX PART #	PAGE #	TRUX PART #	PAGE #	TRUX PART #	PAGE #	TRUX PART #	PAGE #
TLED-U27	35	TLED-WXAB	69	TNUT-F2TL	130	TP-10145	224	TP-10174LM	223
TLED-U28	38	TLED-WXAG	69	TNUT-F2TP	129	TP-10146	224	TP-10174LMC	223
TLED-U29	39	TLED-WXAP	69	TNUT-P1	130	TP-10147	224	TP-10175	223
TLED-U32	33	TLED-WXAR	69	TP-0130	225	TP-10148	224	TP-10175LM	223
TLED-U33	33	TLED-WXAW	69	TP-0196	225	TP-10149	224	TP-10175LMC	223
TLED-U34	36	TLED-WXRB	69	TP-1001	228	TP-10149LM	224	TP-10177	222
TLED-U35	36	TLED-WXRG	69	TP-1003	210	TP-10149LMC	224	TP-10178	222
TLED-U36	50	TLED-WXRP	69	TP-1005	210	TP-10150	224	TP-10179	222
TLED-U4	38	TLED-WXRW	69	TP-1007	209	TP-10150LM	224	TP-10179LM	222
TLED-U40	42	TLED-X1A	100	TP-1009	209	TP-10150LMC	224	TP-10179LMC	222
TLED-U47	49	TLED-X1B	100	TP-10107	218	TP-10151	224	TP-10180	221
TLED-U49	43	TLED-X1G	100	TP-10107LF	218	TP-10151LM	224	TP-10181	222
TLED-U5	35	TLED-X1R	100	TP-10107LFC	218	TP-10151LMC	224	TP-10182	222
TLED-U50	50	TLED-X3A	100	TP-10114	222	TP-10152	224	TP-10183	222
TLED-U6	32	TLED-X3B	100	TP-10115	222	TP-10152LM	224	TP-10183LM	222
TLED-U65	51	TLED-X3G	100	TP-10115LM	222	TP-10152LMC	224	TP-10183LMC	222
TLED-U66	51	TLED-X3R	100	TP-10115LMC	222	TP-10153	223	TP-10195	210
TLED-U67	51	TM-1101	286	TP-10116	222	TP-10154	223	TP-10195L	210
TLED-U68	51	TM-1102	285	TP-10116LM	222	TP-10155	223	TP-10195LC	210
TLED-U69	51	TM-1107	286	TP-10116LMC	222	TP-10155LM	223	TP-10215	218
TLED-U76	52	TM-1109	288	TP-10120	221	TP-10155LMC	223	TP-10215L	218
TLED-U77	52	TM-1110	288	TP-10120LM	221	TP-10156	223	TP-10215LC	218
TLED-U8	39	TM-1202	287	TP-10120LMC	221	TP-10156LM	223	TP-10220	210
TLED-U86	52	TM-1403	288	TP-10127	219	TP-10156LMC	223	TP-10220L	210
TLED-U87	36	TM-1412	286	TP-10127LLM	219	TP-10157	223	TP-10220LC	210
TLED-U88	36	TM-1413	288	TP-10127LMC	219	TP-10158	223	TP-10221	210
TLED-U89	33	TM-1417	285	TP-10130	221	TP-10159	223	TP-10221L	210
TLED-U9	39	TM-1427	286	TP-10130LM	221	TP-10159LM	223	TP-10221LC	210
TLED-U90	33	TM-1429	288	TP-10130LMC	221	TP-10159LMC	223	TP-1062	209
TLED-U93	34	TM-1605	287	TP-10131	221	TP-10160	221	TP-1062LM	209
TLED-U94	34	TM-1606	287	TP-10131LM	221	TP-10161	221	TP-1062LMC	209
TLED-U95	37	TM-1801	287	TP-10131LMC	221	TP-10162	221	TP-1063	210
TLED-U96	37	TM-1802	287	TP-10133	221	TP-10163	221	TP-1063LM	210
TLED-U97	40	TM-2002	154	TP-10133LM	221	TP-10163LM	221	TP-1063LMC	210
TLED-U98	40	TM-2003	154	TP-10133LMC	221	TP-10163LMC	221	TP-1064	209
TLED-W1	45	TM-2008	153	TP-10138	220	TP-10164	221	TP-1064LM	209
TLED-W13A24	47	TM-2009	153	TP-10138LM	220	TP-10164LM	221	TP-1064LMC	209
TLED-W14A26	47	TM-2011	153	TP-10138LMC	220	TP-10164LMC	221	TP-1065	210
TLED-W16A26	47	TM-24	144	TP-10140	222	TP-10165	221	TP-1065LM	210
TLED-W2	45	TM-30	144	TP-10140LM	222	TP-10165LM	221	TP-1065LMC	210
TLED-W23A24	48	TNUT-B1	130	TP-10140LMC	222	TP-10165LMC	221	TP-1066	210
TLED-W24A26	48	TNUT-B2	129	TP-10142	222	TP-10166	221	TP-1066LM	210
TLED-W26A26	48	TNUT-C1	129	TP-10142LM	222	TP-10168	220	TP-1066LMC	210
TLED-W3	29	TNUT-C4	129	TP-10142LMC	222	TP-10170	223	TP-1067	210
TLED-W4	29	TNUT-F1	130	TP-10143	222	TP-10171	223	TP-1067LM	210
TLED-W5	46	TNUT-F1SS	130	TP-10143LM	222	TP-10172	223	TP-1067LMC	210
TLED-WA	91	TNUT-F2	129	TP-10143LMC	222	TP-10173	223	TP-1090	210
TLED-WCA	91	TNUT-F2L	129	TP-10144	223	TP-10173LM	223	TP-1091	210
TLED-WCR	91	TNUT-F2T	130	TP-10144LM	223	TP-10173LMC	223	TP-1092	210
TLED-WR	91	TNUT-F2TB	130	TP-10144LMC	223	TP-10174	223	TP-1093	210

TRUX PART #	PAGE #
TP-1102	228
TP-1104	228
TP-1109	207
TP-1112	230
TP-1113	230
TP-1119	229
TP-1123	233
TP-1124	202
TP-1125	202
TP-1128	234
TP-1129	232
TP-1131	204
TP-1139	203
TP-1143	227
TP-1144	227
TP-1201	229
TP-1210	230
TP-1211	230
TP-1218	232
TP-1219	229
TP-1228	230
TP-1301	208
TP-1302	208
TP-1302L	208
TP-1302LC	208
TP-1303	208
TP-1303LM	208
TP-1303LMC	208
TP-1304	207
TP-1305	207
TP-1305L	207
TP-1305LC	207
TP-1306	207
TP-1306LM	207
TP-1306LMC	207
TP-1310	214
TP-13100	213
TP-13101	214
TP-13102	215
TP-13110	208
TP-13110L	208
TP-13110LC	208
TP-13116	215
TP-13116L	215
TP-13116LC	215
TP-13120	213
TP-13120L	213
TP-13120LC	213
TP-13121	214
TP-13121L	214

TRUX PART #	PAGE #
TP-13121LC	214
TP-13126	207
TP-13126L	207
TP-13126LC	207
TP-13149	214
TP-13150	214
TP-13159	214
TP-13159LM	214
TP-13159LMC	214
TP-13166	215
TP-13166LM	215
TP-13166LMC	215
TP-13167	215
TP-13167L	215
TP-13167LC	215
TP-13168	214
TP-13168LM	214
TP-13168LMC	214
TP-13169	214
TP-13169L	214
TP-13169LC	214
TP-13170	214
TP-13170L	214
TP-13170LC	214
TP-13171	215
TP-1396	213
TP-1396LM	213
TP-1396LMC	213
TP-1397	215
TP-1397LM	215
TP-1397LMC	215
TP-1398	214
TP-1398LM	214
TP-1398LMC	214
TP-1401	225
TP-1402	225
TP-1407	225
TP-1413	227
TP-1431	225
TP-1433	233
TP-1434	232
TP-1436	226
TP-1437	226
TP-1438	226
TP-1439	226
TP-1440	234
TP-1440	254
TP-1444	234
TP-1445	234
TP-1446	226

TRUX PART #	PAGE #
TP-1501	208
TP-1501	208
TP-1502	208
TP-1502L	208
TP-1502LC	208
TP-1503	208
TP-1503	208
TP-1503LM	208
TP-1503LM	208
TP-1503LMC	208
TP-1503LMC	208
TP-1504	208
TP-1504	208
TP-1505	208
TP-1505L	208
TP-1505LC	208
TP-1506	208
TP-1506	208
TP-1506LM	208
TP-1506LM	208
TP-1506LMC	208
TP-1506LMC	208
TP-1510	208
TP-1510	208
TP-1511	208
TP-15118	217
TP-15118LM	217
TP-15118LMC	217
TP-15119	217
TP-15119LM	217
TP-15119LMC	217
TP-1511L	208
TP-1511LC	208
TP-1512	208
TP-1512	208
TP-15120	216
TP-15120LM	216
TP-15120LMC	216
TP-15128	208
TP-15128L	208
TP-15128LC	208
TP-15129	209
TP-15129L	209
TP-15129LC	209
TP-1512LM	208
TP-1512LM	208
TP-1512LMC	208
TP-1512LMC	208
TP-1513	209
TP-15132	208

TRUX PART #	PAGE #
TP-15132L	208
TP-15132LC	208
TP-15137	217
TP-15139	216
TP-15139L	216
TP-15139LC	216
TP-1514	209
TP-15140	209
TP-15140	217
TP-15140L	209
TP-15140L	217
TP-15140LC	209
TP-15140LC	217
TP-1514L	209
TP-1514LC	209
TP-1515	209
TP-15152	215
TP-15152L	215
TP-15152LC	215
TP-15156	215
TP-15156L	215
TP-15156LC	215
TP-15158	215
TP-15159	216
TP-1515LM	209
TP-1515LMC	209
TP-1516	209
TP-15160	216
TP-15162	217
TP-15163	217
TP-1517	209
TP-1517L	209
TP-1517LC	209
TP-1518	209
TP-15185	217
TP-15185LM	217
TP-15185LMC	217
TP-1518LM	209
TP-1518LMC	209
TP-15200	217
TP-15200L	217
TP-15200LC	217
TP-15201	216
TP-15201L	216
TP-15201LC	216
TP-15203	217
TP-15203LM	217
TP-15203LMC	217
TP-15204	216
TP-15204LM	216

TRUX PART #	PAGE #
TP-15204LMC	216
TP-15205	216
TP-15205LM	216
TP-15205LMC	216
TP-15207	215
TP-15207LM	215
TP-15207LMC	215
TP-15208	215
TP-15208LM	215
TP-15208LMC	215
TP-15209	216
TP-15210	216
TP-15210L	216
TP-15210LC	216
TP-15211	215
TP-15212	215
TP-15212L	215
TP-15212LC	215
TP-15213	216
TP-15214	215
TP-15215	215
TP-15215L	215
TP-15215LC	215
TP-15216	217
TP-1571	216
TP-1571LM	216
TP-1571LMC	216
TP-1583	215
TP-1585	215
TP-1585LM	215
TP-1585LMC	215
TP-1588	215
TP-1588LM	215
TP-1588LMC	215
TP-1595	217
TP-1602	226
TP-1606	231
TP-1622B	227
TP-1643	233
TP-1645	227
TP-1646	233
TP-1648	233
TP-1651	227
TP-1662	227
TP-1662T	227
TP-1701	231
TP-1702	231
TP-1703	231
TP-1801	205
TP-1801L	205

# TRUX INDEX

TRUX PART #	PAGE #	TRUX PART #	PAGE #	TRUX PART #	PAGE #	TRUX PART #	PAGE #	TRUX PART #	PAGE #
TP-1801LC	205	TP-1822	212	TP-1864L	212	TRX-121	299	TRX-228	301
TP-1803	206	TP-1822L	206	TP-1864LC	206	TRX-122	299	TRX-233	320
TP-1803L	206	TP-1822L	212	TP-1864LC	212	TRX-123	323	TRX-234	320
TP-1803LC	206	TP-1822LC	206	TP-1865	211	TRX-124	299	TRX-235	56
TP-1805	206	TP-1822LC	212	TP-1865L	211	TRX-130	303	TRX-235	85
TP-1805L	206	TP-1840	205	TP-1865LC	211	TRX-131	298	TRX-235	311
TP-1805LC	206	TP-1840	212	TP-1866	212	TRX-132	297	TRX-236	85
TP-1808	205	TP-1840LM	205	TP-1866L	212	TRX-133	297	TRX-236	311
TP-1808	211	TP-1840LM	212	TP-1866LC	212	TRX-134	301	TRX-237	87
TP-1808L	205	TP-1840LMC	205	TP-1867	212	TRX-135	31	TRX-237	314
TP-1808L	211	TP-1840LMC	212	TP-1867L	212	TRX-135	315	TRX-238	312
TP-1808LC	205	TP-1846	211	TP-1867LC	212	TRX-136	76	TRX-239	31
TP-1808LC	211	TP-1846L	211	TP-1868	206	TRX-136	313	TRX-239	316
TP-1809	206	TP-1846LC	211	TP-1868	212	TRX-140	82	TRX-240	317
TP-1809	212	TP-1847	211	TP-1868LM	206	TRX-140	309	TRX-241	317
TP-1809L	206	TP-1847L	211	TP-1868LM	212	TRX-142	82	TRX-244	321
TP-1809L	212	TP-1847LC	211	TP-1868LMC	206	TRX-142	309	TRX-245	321
TP-1809LC	206	TP-1852	205	TP-1868LMC	212	TRX-143	298	TRX-246	321
TP-1809LC	212	TP-1852	211	TP-2010	197	TRX-144	297	TSK-5Y	197
TP-1810	206	TP-1852LM	205	TPIG-2W	116	TRX-157	318	TSK-8Y	197
TP-1810	212	TP-1852LM	211	TPIG-3W	116	TRX-158	318	TSK10-52S	192
TP-1810L	206	TP-1852LMC	205	TPIG-H1	116	TRX-159	318	TSK10-55S	192
TP-1810L	212	TP-1852LMC	211	TPIG-L1	116	TRX-160	318	TSK10-B54T	191
TP-1810LC	206	TP-1853	211	TPIG-L2	116	TRX-165	301	TSK10-B60T	191
TP-1810LC	212	TP-1853LM	211	TRX-012	319	TRX-167	307	TSK10-BSET	186
TP-1812	206	TP-1853LMC	211	TRX-014	319	TRX-168	307	TSK10-BSET2	186
TP-1812LM	206	TP-1854	212	TRX-029	320	TRX-169	302	TSK10-BSET3	186
TP-1812LMC	206	TP-1854LM	212	TRX-054	319	TRX-170	302	TSK10-BSET4	186
TP-1814	205	TP-1854LMC	212	TRX-063	322	TRX-171	297	TSK10-C54T	191
TP-1814L	205	TP-1855	205	TRX-067	321	TRX-172	308	TSK10-C60T	191
TP-1814LC	205	TP-1855	212	TRX-068	321	TRX-173	308	TSK10-CSET	186
TP-1816	206	TP-1855LM	205	TRX-070	321	TRX-178	318	TSK10-CSET3	186
TP-1816L	206	TP-1855LM	212	TRX-071	321	TRX-186	306	TSK10-CSET4	186
TP-1816LC	206	TP-1855LMC	205	TRX-072	319	TRX-187	306	TSK10-F54T	191
TP-1818	206	TP-1855LMC	212	TRX-076	306	TRX-190	306	TSK10-F60T	191
TP-1818L	206	TP-1857	206	TRX-078	304	TRX-191	318	TSK10-FSET	186
TP-1818LC	206	TP-1857	212	TRX-079	305	TRX-200	320	TSK10-FSET2	186
TP-1820	205	TP-1857LLMC	206	TRX-084	321	TRX-201	320	TSK10-FSET3	186
TP-1820	211	TP-1857LM	206	TRX-089	299	TRX-202	320	TSK10-FSET4	186
TP-1820L	205	TP-1857LM	212	TRX-090	299	TRX-203	320	TSK10-M54T	191
TP-1820L	211	TP-1857LMC	212	TRX-091	304	TRX-204	320	TSK10-M60T	191
TP-1820LC	205	TP-1863	205	TRX-092	305	TRX-205	320	TSK10-MSET	186
TP-1820LC	211	TP-1863	211	TRX-093	305	TRX-206	320	TSK10-MSET2	186
TP-1821	206	TP-1863L	205	TRX-094	303	TRX-208	320	TSK10-MSET2	186
TP-1821	212	TP-1863L	211	TRX-100	318	TRX-209	319	TSK10-MSET3	186
TP-1821L	206	TP-1863LC	205	TRX-102	299	TRX-214	320	TSK10-MSET4	186
TP-1821L	212	TP-1863LC	211	TRX-103	321	TRX-223	83	TSK10K	198
TP-1821LC	206	TP-1864	206	TRX-105	319	TRX-223	310	TSK5-B036	195
TP-1821LC	212	TP-1864	212	TRX-112	308	TRX-224	83	TSK5-B048	195
TP-1822	206	TP-1864L	206	TRX-113	307	TRX-224	310	TSK5-B060	195



TRUX PART #	PAGE #
TSK5-C036	195
TSK5-C048	195
TSK5-C060	195
TSK5-M036	195
TSK5-M048	195
TSK5-M060	195
TSK5K	198
TSK6-52S	192
TSK6-55S	192
TSK6-B54T	191
TSK6-B60T	191
TSK6-BSET	182
TSK6-BSET2	182
TSK6-BSET3	188
TSK6-BSET4	188
TSK6-BSET5	184
TSK6-BSET6	184
TSK6-BSET7	190
TSK6-BSET8	190
TSK6-C54T	191
TSK6-C60T	191
TSK6-CSET	182
TSK6-CSET2	182
TSK6-CSET3	188
TSK6-CSET4	188
TSK6-CSET5	184
TSK6-CSET6	184
TSK6-CSET7	190
TSK6-CSET8	190
TSK6-M54T	191
TSK6-M60T	191
TSK6-MSET	182
TSK6-MSET2	182
TSK6-MSET3	188
TSK6-MSET4	188
TSK6-MSET5	184
TSK6-MSET6	184
TSK6-MSET7	190
TSK6-MSET8	190
TSK65-52S	192
TSK65-B036	196
TSK65-B048	196
TSK65-B060	196
TSK65-C036	196
TSK65-C048	196
TSK65-C060	196
TSK65-M036	196
TSK65-M048	196
TSK65-M060	196
TSK6K	198

TRUX PART #	PAGE #
TSK7-52S	192
TSK7-55S	192
TSK7-B54T	191
TSK7-B60T	191
TSK7-BSET	182
TSK7-BSET2	182
TSK7-BSET3	188
TSK7-BSET4	188
TSK7-BSET5	184
TSK7-BSET6	184
TSK7-BSET7	190
TSK7-BSET8	190
TSK7-C54T	191
TSK7-C60T	191
TSK7-CSET	182
TSK7-CSET2	182
TSK7-CSET3	188
TSK7-CSET4	188
TSK7-CSET5	184
TSK7-CSET6	184
TSK7-CSET7	190
TSK7-CSET8	190
TSK7-M54T	191
TSK7-M60T	191
TSK7-MSET	182
TSK7-MSET2	182
TSK7-MSET3	188
TSK7-MSET4	188
TSK7-MSET5	184
TSK7-MSET6	184
TSK7-MSET7	190
TSK7-MSET8	190
TSK75-52S	192
TSK75-55S	192
TSK75-B048	196
TSK75-B060	196
TSK75-C048	196
TSK75-C060	196
TSK75-M048	196
TSK75-M060	196
TSK7K	198
TSK8-52S	192
TSK8-55S	192
TSK8-B54T	191
TSK8-B60T	191
TSK8-BSET	182
TSK8-BSET2	182
TSK8-BSET3	184
TSK8-BSET4	184
TSK8-BSET5	188

TRUX PART #	PAGE #
TSK8-BSET6	188
TSK8-BSET7	190
TSK8-BSET8	190
TSK8-C54T	191
TSK8-C60T	191
TSK8-CSET	182
TSK8-CSET2	182
TSK8-CSET3	184
TSK8-CSET4	184
TSK8-CSET5	188
TSK8-CSET6	188
TSK8-CSET7	190
TSK8-CSET8	190
TSK8-F54T	191
TSK8-F60T	191
TSK8-FSET	182
TSK8-FSET2	182
TSK8-FSET3	188
TSK8-FSET4	184
TSK8-FSET5	184
TSK8-FSET6	188
TSK8-FSET7	190
TSK8-FSET8	190
TSK8-M54T	191
TSK8-M60T	191
TSK8-MSET	182
TSK8-MSET2	182
TSK8-MSET3	184
TSK8-MSET4	188
TSK8-MSET5	184
TSK8-MSET6	188
TSK8-MSET7	190
TSK8-MSET8	190
TSK8K	198
TSUN-F1	265
TSUN-F17	264
TSUN-F19	264
TSUN-F2	265
TSUN-F21	264
TSUN-F24	263
TSUN-F25	263
TSUN-F26	263
TSUN-F27	266
TSUN-F28	266
TSUN-F3	265
TSUN-F32	263
TSUN-F37	263
TSUN-F4	265
TSUN-F6	264
TSUN-F70	263

TRUX PART #	PAGE #
TSUN-F71	263
TSUN-F8	264
TSUN-I1	281
TSUN-I10	282
TSUN-I11	282
TSUN-I12	282
TSUN-I18	282
TSUN-I2	281
TSUN-I5	281
TSUN-I7	281
TSUN-I8	281
TSUN-I9	281
TSUN-K1	235
TSUN-K11	236
TSUN-K12	236
TSUN-K13	235
TSUN-K14	235
TSUN-K2	235
TSUN-K20	237
TSUN-K21	237
TSUN-K22	237
TSUN-K23	237
TSUN-K4	235
TSUN-K45	237
TSUN-K5	236
TSUN-K6	235
TSUN-K8	236
TSUN-M1	285
TSUN-M2	285
TSUN-M3	285
TSUN-P1	199
TSUN-P11	201
TSUN-P14	199
TSUN-P17	201
TSUN-P2	199
TSUN-P20	200
TSUN-P24	200
TSUN-P25	199
TSUN-P26	199
TSUN-P27	201
TSUN-P28	200
TSUN-P30	200
TSUN-P57	201
TSUN-P8	201
TSUN-V1	277
TSUN-V2	277
TSUN-W1	289
TSUN-W2	289
TSUN-W3	289
TSUN-W8	289

TRUX PART #	PAGE #
TT-100	296
TT-101	296
TT-102	296
TT-1032XL	294
TT-103L	294
TT-103M	294
TT-103XL	294
TT-1042XL	294
TT-104L	294
TT-104M	294
TT-104XL	294
TT-1052XL	294
TT-105L	294
TT-105M	294
TT-105XL	294
TT-1062XL	295
TT-106L	295
TT-106M	295
TT-106XL	295
TT-1072XL	295
TT-107L	295
TT-107M	295
TT-107XL	295
TT-1082XL	295
TT-108L	295
TT-108M	295
TT-108XL	295
TT-109	296
TU-1005	116
TU-1007	112
TU-1029	98
TU-1029A	98
TU-1029W	98
TU-1030	142
TU-1031	144
TU-1032	144
TU-1033	130
TU-1037	130
TU-1039	116
TU-1043	01
TU-1043	114
TU-1045	03
TU-1046	50
TU-1047	50
TU-1048	50
TU-1049	50
TU-1050	50
TU-1051	50
TU-1400	142
TU-1601	151

# TRUX INDEX

TRUX PART #	PAGE #
TU-1601L	151
TU-1601L2	152
TU-1601L3	152
TU-1601L4	152
TU-1601L5	152
TU-1601LC	151
TU-1714	142
TU-1715	142
TU-1716	142
TU-9001	145
TU-9001L	145
TU-9001L2	146
TU-9001L3	146
TU-9001L4	146
TU-9001L5	146
TU-9001L6	146
TU-9001LC	145
TU-9002	147
TU-9002L	147
TU-9002L2	148
TU-9002L3	148
TU-9002L4	148
TU-9002L5	148
TU-9002L6	148
TU-9002LC	147
TU-9008	150
TU-9008L	150
TU-9008LC	150
TU-9013L	150
TU-9013LC	150
TU-9017	149
TU-9017L1	149
TU-9017L2	149
TU-9017L4	149
TU-9017LC	149
TU-9204	143
TU-9208	144
TU-9209	133
TU-9209L1	133
TU-9209L2	134
TU-9209L3	134
TU-9209L4	134
TU-9209L5	134
TU-9209L6	134
TU-9209LC	133
TU-9210	135
TU-9210L1	135
TU-9210L2	136
TU-9210L3	136
TU-9210L4	136

TRUX PART #	PAGE #
TU-9210L5	136
TU-9210L6	136
TU-9210LC	135
TU-9214	140
TU-9215	140
TU-9217	137
TU-9217L	137
TU-9217LC	137
TU-9221	139
TU-9222	139
TU-9223	139
TU-9224	140
TU-9225	140
TU-9226	140
TU-9227	139
TU-9228	139
TU-9229	139
TU-9230	138
TU-9231	138
TU-9232	140
TU-9233	140
TU-9239	143
TU-9241	143
TU-9242	143
TU-9245	138
TU-9245LF	138
TU-9245LFC	138
TU-9245LFC2	138
TU-9246	143
TU-9248	138
TU-9249	138
TU-9250	138
TU-9258	137
TU-9259	137
TV-1002	280
TV-1102	278
TV-1103	278
TV-1104	278
TV-1203	278
TV-1404	277
TV-1406	279
TV-1408	279
TV-1413	280
TV-1415	280
TV-1421	279
TV-1436	279
TV-1440	280
TV-1462	280
TV-1701	278
TW-1101	291

TRUX PART #	PAGE #
TW-1105	291
TW-1203	291
TW-1207	291
TW-1401	292
TW-1404	292
TW-1407	292
TW-1411	292

# VISIT OUR WEBSITE FOR NEW & INNOVATIVE PRODUCTS



# TRUXACCESSORIES.COM



**ON A BREAK?  
KEEP UP TO DATE  
ON ALL THINGS TRUX**



Facebook  
[facebook.com/GOTRUX/](https://facebook.com/GOTRUX/)



Twitter  
[@getrux](https://twitter.com/getrux)



Instagram  
[@truxaccessories](https://www.instagram.com/truxaccessories)



Issuu.com  
[issuu.com/truxaccessories](https://issuu.com/truxaccessories)

# BE ORIGINAL



**1-888-950-2227**  
**TRUXACCESSORIES.COM**