



Sleeve style air springs are used for cab and seating applications, creating a smooth, comfortable ride.

READING THE PARTS TABLE

<p>1 LOGO ORANGE</p>	<p>2 AON W02-358-7058</p>	<p>7 1.30</p> <p>8 Composite</p>
	<p>4 CAP ID NO. NBD-10409 (7042)</p> <p>5 PISTON ID NO. NBD-12708 (6896)</p> <p>6 BCR 9.00</p>	<p>9 APPLICATIONS: NATIONAL SEATING 324662-01 (W02-N19-7058)</p> <p>10 OBSOLETE</p>

- 1. Logo Color**
The Airide spring shield color indicates a very specific construction of the bellows, which helps with the identification process of the air spring.
- 2. Assembly Order Number (AON)**
This number identifies the specific Firestone assembly order number that needs to be used for ordering purposes. It is important that the complete order number is used to avoid any confusion, especially with any type of electronic ordering. The complete order number in this example is W02-358-7058.
- 3. Cross Section View**
Includes dimensional information in inches for uninflated diameter, maximum height, and collapsed height, as well as component dimensions.
- 4. Cap Identification Number**
The drawing number is molded into most caps, followed by a 4 digit number in parentheses identifying the internal cap component number. Do not confuse this code with the AON.

- 5. Piston Identification Number**
The piston identification number is molded into most pistons, followed by a 4 digit number in parentheses identifying the internal piston component number. Do not confuse this code with the AON.
- 6. BCR**
This dimension is the measurement taken between the two metal rings on each end of the assembly. Note: BCR measurement will be somewhat shorter than specified in this guide.
- 7. Weight**
The total weight of the spring assembly.
- 8. Piston Material**
Aluminum, Steel, or Composite.
- 9. Applications**
Includes all the information that is known about this specific application (i.e., model number, years of manufacture, part numbers, Firestone reference numbers, and competitor numbers, if known).
- 10. Assembly Notes**
Important information if an assembly has been obsoleted and if there is an exact replacement part available, or if it has replaced other parts.

AIR SPRING IDENTIFICATION

Assembly Order Number (AON) 2

The quickest way to identify the air spring is to read the manufacturer or Firestone assembly order number (AON) on the label adhered to the cap. The complete order number must include the W02 number at the beginning. Use the following pages to find the correct number for your air spring. The complete AON in the diagram is W02-358-7058.

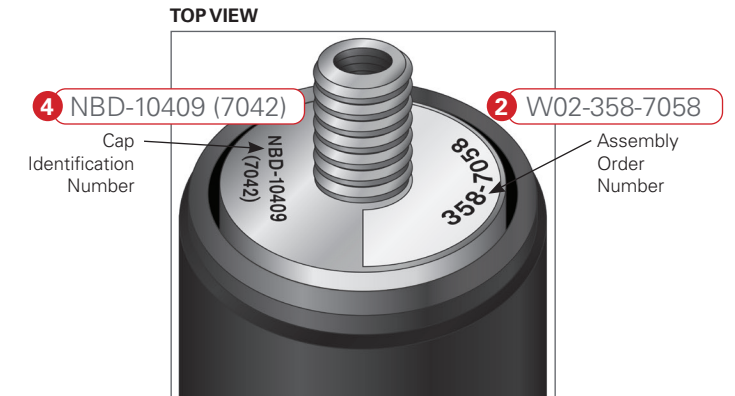

Logo Color 1

The parts tables are sorted by the air spring logo color. If the AON number is not legible, identify the Airide spring shield color to narrow down your search. From there, follow the steps below to identify your air spring.

Cap Identification Number 4

The cap can be used for further part identification in the parts diagrams by matching the drawing number (e.g. NBD-10409) or the cap component number (7042). In addition, the crimp (metal) ring around the cap has a code stamped into it. The last 4 digits of the seven-number string at the beginning of the code reference the cap identification number.

Piston Identification Number 5

The piston drawing (NBD-12708) or internal piston component number (6896) molded into the piston can also be used to narrow down the search for the correct replacement part.

BCR 6

If an additional identifier is needed, measure the distance between the two metal rings – one holding the cap in place and the other holding the bellows on the piston. This measurement is called the BCR, and is identified in the parts diagrams.

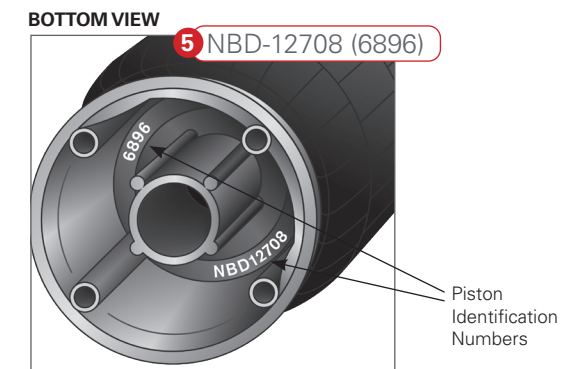

LOGO ORANGE	AON W02-358-7018	1.02 Aluminum
	<p>CAP ID NO. NBD-10183 (7013)</p> <p>PISTON ID NO. NBD-10795 (7054)</p> <p>BCR \updownarrow 5.00</p>	<p>APPLICATIONS:</p>

LOGO ORANGE	AON W02-358-7086	0.61 Composite
	<p>CAP ID NO. NBD-10218 (7018)</p> <p>PISTON ID NO. NBD-16538 (6913)</p> <p>BCR \updownarrow 5.25</p>	<p>APPLICATIONS: LINK MANUFACTURING LTD 1102-0025 (FORD)</p>

LOGO ORANGE	AON W02-358-7046	0.70 Composite
	<p>CAP ID NO. NBD-10470 (7068)</p> <p>PISTON ID NO. NBD-16537 (6912)</p> <p>BCR \updownarrow 6.00</p>	<p>APPLICATIONS: LINK MANUFACTURING LTD 1102-0022 (FORD, FRT, GMC, PETE)</p>

LOGO ORANGE	AON W02-358-7079	0.65 Composite
	<p>CAP ID NO. NBD-11636 (7074)</p> <p>PISTON ID NO. NBD-16537 (6912)</p> <p>BCR \updownarrow 6.00</p>	<p>APPLICATIONS: LINK MANUFACTURING LTD 1102-0026 (NAV.)</p>

LOGO ORANGE	AON W02-358-7001	0.69 Composite
	<p>CAP ID NO. NBD-10218 (7018)</p> <p>PISTON ID NO. NBD-16538 (6913)</p> <p>BCR \updownarrow 6.25</p>	<p>APPLICATIONS: LINK MANUFACTURING LTD 1102-0020 (NAV.) SEE 1102-0023 1102-0023 (FORD, FRT, GMC, KW, NAV., VOLVO) COMFORT RIDE WISE KENWORTH T81-1001</p>

LOGO ORANGE	AON W02-358-7002	1.04 Aluminum
	<p>CAP ID NO. NBD-10082 (7014)</p> <p>PISTON ID NO. NBD-10549 (7049)</p> <p>BCR \updownarrow 6.75</p>	<p>APPLICATIONS:</p>

LOGO ORANGE	AON W02-358-7150	0.68 Composite
	<p>CAP ID NO. NBD-10239 (7015)</p> <p>PISTON ID NO. NBD-16537 (6912)</p> <p>BCR \updownarrow 7.00</p>	<p>APPLICATIONS: SEARS / DURAFORM S13384 (W02-811-7150)</p>

LOGO ORANGE	AON W02-358-7201	0.89 Composite
	<p>CAP ID NO. NBD-10218 (7018)</p> <p>PISTON ID NO. NBD-16538 (6913)</p> <p>BCR \updownarrow 7.25</p>	<p>APPLICATIONS: FREIGHTLINER / STERLING 18-45068-000 STERLING DAY CAB OLD FORD # P/N F6HT5C06CAB HN-80 DAY CAB (1996 & LATER)</p>

LOGO ORANGE	AON W02-358-7100	0.71 Composite
	<p>APPLICATIONS: 3-TS W02-T03-7100</p> <p>CAP ID NO. NBD-10470 (7068)</p> <p>PISTON ID NO. NBD-16537 (6912)</p> <p>BCR \updownarrow 7.50</p>	

LOGO ORANGE	AON W02-358-7132	0.76 Composite
	<p>APPLICATIONS: PETERBILT R81-6003</p> <p>CAP ID NO. NBD-10218 (7018)</p> <p>PISTON ID NO. NBD-16510 (6908)</p> <p>BCR \updownarrow 7.50</p>	

LOGO ORANGE	AON W02-358-7041	0.90 Composite
	<p>APPLICATIONS: SEARS / DURAFORM S8645 (W02-811-7041)</p> <p>CAP ID NO. NBD-10239 (7015)</p> <p>PISTON ID NO. FIP-102217 (9636)</p> <p>BCR \updownarrow 8.25</p>	

LOGO ORANGE	AON W02-358-7059	0.90 Composite
	<p>APPLICATIONS: NATIONAL SEATING 324663-01 (W02-N19-7059) 328035-01 (W02-N19-7069) 329666-01 (W02-N19-7084)</p> <p>CAP ID NO. NBD-10409 (7042)</p> <p>PISTON ID NO. NBD-12708 (6896)</p> <p>BCR \updownarrow 8.25</p>	

LOGO ORANGE	AON W02-358-7058	0.94 Composite
	<p>APPLICATIONS: NATIONAL SEATING 324662-01 (W02-N19-7058)</p> <p>CAP ID NO. NBD-10409 (7042)</p> <p>PISTON ID NO. NBD-12708 (6896)</p> <p>BCR \updownarrow 9.00</p>	

LOGO ORANGE	AON W02-358-7054	0.90 Composite
	<p>APPLICATIONS: WISE</p> <p>CAP ID NO. NBD-10218 (7018)</p> <p>PISTON ID NO. FIP-102216 (9638)</p> <p>BCR \updownarrow 9.25</p>	

LOGO ORANGE	AON W02-358-7098	0.90 Composite
	<p>APPLICATIONS: LINK MANUFACTURING LTD 1102-0027</p> <p>CAP ID NO. NBD-13262 (6997)</p> <p>PISTON ID NO. FIP-102216 (9638)</p> <p>BCR \updownarrow 9.62</p> <p>OBsolete: NO LONGER AVAILABLE</p>	

LOGO ORANGE	AON W02-358-7010	1.44 Aluminum
	<p>APPLICATIONS:</p> <p>CAP ID NO. NBD-10010 (7007)</p> <p>PISTON ID NO. NBD-10071 (7023)</p> <p>BCR \updownarrow 10.00</p>	

LOGO ORANGE	AON W02-358-7040	1.06 Composite
	<p>CAP ID NO. NBD-10239 (7015)</p> <p>PISTON ID NO. FIP-102217 (9636)</p> <p>BCR \updownarrow 10.00</p>	<p>APPLICATIONS: KNOEDLER 7010 AL (USE 7040) (W02-K50-7060) SEARS / DURAFORM S5388 SEATS 707338 AIR FLEX</p>

LOGO ORANGE	AON W02-358-7049	0.98 Composite
	<p>CAP ID NO. NBD-10470 (7068)</p> <p>PISTON ID NO. FIP-102217 (9636)</p> <p>BCR \updownarrow 10.00</p>	<p>APPLICATIONS: 3-TS W02-T03-7049</p> <p>OBSOLETE: NO LONGER AVAILABLE</p>

LOGO ORANGE	AON W02-358-7055	0.94 Composite
	<p>CAP ID NO. NBD-10409 (7042)</p> <p>PISTON ID NO. FIP-102215 (9637)</p> <p>BCR \updownarrow 10.00</p>	<p>APPLICATIONS: NATIONAL SEATING 2112283 7050 PLASTIC (USE 7055)</p>

LOGO ORANGE	AON W02-358-7149	0.97 Composite
	<p>CAP ID NO. NBD-10470 (7068)</p> <p>PISTON ID NO. NBD-12708 (6896)</p> <p>BCR \updownarrow 10.00</p>	<p>APPLICATIONS: 3-TS W02-T03-7149</p>

LOGO ORANGE	AON W02-358-7073	1.50 Aluminum
	<p>CAP ID NO. NBD-10183 (7013)</p> <p>PISTON ID NO. NBD-10071 (7023)</p> <p>BCR \updownarrow 11.00</p>	<p>APPLICATIONS: CARE CONCEPT</p> <p>OBSOLETE: NO LONGER AVAILABLE</p>

LOGO GREEN	AON W02-358-7031	1.06 Aluminum
	<p>CAP ID NO. NBD-10082 (7014)</p> <p>PISTON ID NO. NBD-10549 (7049)</p> <p>BCR \updownarrow 7.00</p>	<p>APPLICATIONS: MACK 227QS33 GY 1S4-007</p>

LOGO GREEN	AON W02-358-7209	0.70 Composite
	<p>CAP ID NO. NBD-10409 (7042)</p> <p>PISTON ID NO. FIP-100105 (6979)</p> <p>BCR \updownarrow 7.00</p>	<p>APPLICATIONS: SEATS 708220 NBD-10409 FIP-100105 (W02-812-7209)</p> <p>OBSOLETE: NO LONGER AVAILABLE</p>

LOGO GREEN	AON W02-358-7106	0.90 Composite
	<p>CAP ID NO. NBD-13262 (6997)</p> <p>PISTON ID NO. FIP-102215 (9637)</p> <p>BCR \updownarrow 9.87</p>	<p>APPLICATIONS: LINK MANUFACTURING LTD 1102-0030 (PETE.)</p>

LOGO GREEN	AON W02-358-7085	1.51 Aluminum
	<p>APPLICATIONS: AIR FLEX (W02-A05-7085)</p> <p>CAP ID NO. NBD-10183 (7013)</p> <p>PISTON ID NO. NBD-10071 (7023)</p> <p>BCR \updownarrow 11.50</p>	

LOGO RED	AON W02-358-7007	1.06 Aluminum
	<p>APPLICATIONS: MACK 227QS34 GY 1S6-067</p> <p>CAP ID NO. NBD-9930 (7005)</p> <p>PISTON ID NO. NBD-10549 (7049)</p> <p>BCR \updownarrow 6.25</p>	

LOGO RED	AON W02-358-7204	2.08 Composite
	<p>APPLICATIONS: FREIGHTLINER / STERLING STERLING ACTERA 18-43472-000</p> <p>CAP ID NO. NBD-13706 (6990)</p> <p>PISTON ID NO. NBD-16538 (6913)</p> <p>BCR \updownarrow 8.00</p> <p>OBSELETE: NO LONGER AVAILABLE</p>	

LOGO RED	AON W02-358-7080	0.90 Composite
	<p>APPLICATIONS: LINK MANUFACTURING LTD 1102-0031 (FRT.)</p> <p>CAP ID NO. NBD-10239 (7015)</p> <p>PISTON ID NO. FIP-102217 (9636)</p> <p>BCR \updownarrow 10.00</p>	

LOGO PINK	AON W02-358-7070	0.69 Composite
	<p>APPLICATIONS: NATIONAL SEATING 2123403 (W02-N19-7070) W02-N19-7160</p> <p>CAP ID NO. NBD-10409 (7042)</p> <p>PISTON ID NO. NBD-16536 (6911)</p> <p>BCR \updownarrow 7.50</p>	

LOGO PINK	AON W02-358-7115	0.70 Composite
	<p>APPLICATIONS:</p> <p>CAP ID NO. NBD-10604 (7050)</p> <p>PISTON ID NO. NBD-16537 (6912)</p> <p>BCR \updownarrow 7.50</p>	

LOGO PINK	AON W02-358-7116	0.95 Composite
	<p>APPLICATIONS: LINK MANUFACTURING 1101-0030</p> <p>CAP ID NO. NBD-10604 (7050)</p> <p>PISTON ID NO. FIP-102217 (9636)</p> <p>BCR \updownarrow 11.38</p>	

LOGO WHITE	AON W02-358-7025	1.08 Aluminum
	<p>APPLICATIONS: FREIGHTLINER / WESTERN STAR (STYLE #25 BELLOWS)</p> <p>CAP ID NO. NBD-10183 (7013)</p> <p>PISTON ID NO. NBD-10795 (7054)</p> <p>BCR \updownarrow 6.50</p>	

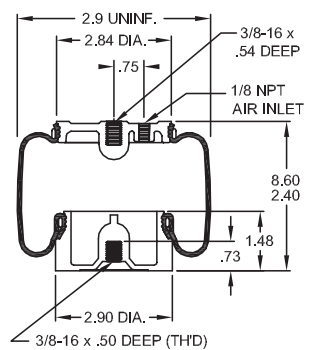
LOGO WHITE	AON W02-358-7035	0.72 Composite
	<p>APPLICATIONS: SEARS / DURAFORM S9383 (W02-811-7035) 7025 AL (USE 7035)</p> <p>CAP ID NO. NBD-10470 (7068)</p> <p>PISTON ID NO. NBD-16537 (6912)</p> <p>BCR \updownarrow 6.50</p>	

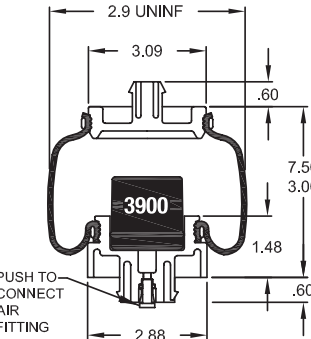
LOGO WHITE	AON W02-358-7206	0.95 Composite
	<p>APPLICATIONS: FREIGHTLINER 18-29919-000 CENTURY CLASS & ARGOSY COE (W02-377-7202) 2002 AND EARLIER</p> <p>CAP ID NO. NBD-15430 (6987)</p> <p>PISTON ID NO. NBD-15431 (6986)</p> <p>BCR \updownarrow 6.50</p> <p>REPLACES W02-358-7202</p>	

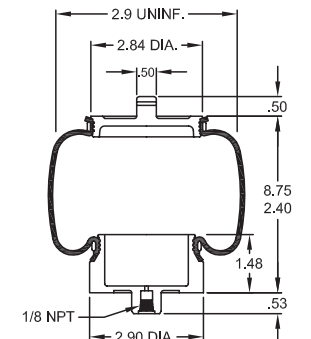
LOGO WHITE	AON W02-358-7087	0.76 Composite
	<p>APPLICATIONS: FREIGHTLINER FLD (1988 & LATER) GY 1S5-040</p> <p>CAP ID NO. NBD-10409 (7042)</p> <p>PISTON ID NO. NBD-16536 (6911)</p> <p>BCR \updownarrow 6.75</p>	

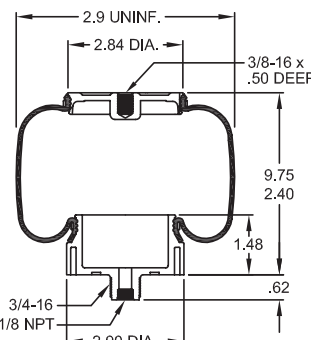
LOGO WHITE	AON W02-358-7075	0.71 Composite
	<p>APPLICATIONS: LINK MANUFACTURING LTD 1102-0048</p> <p>CAP ID NO. NBD-10218 (7018)</p> <p>PISTON ID NO. NBD-16538 (6913)</p> <p>BCR \updownarrow 7.75</p>	

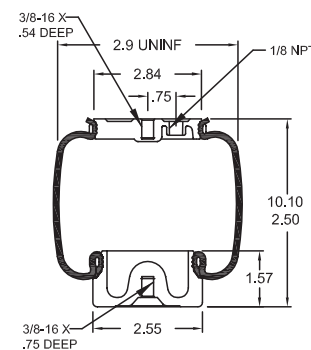
LOGO WHITE	AON W02-358-7037	1.04 Aluminum
	<p>APPLICATIONS: AIR FLEX (W02-A05-7037)</p> <p>CAP ID NO. NBD-10183 (7013)</p> <p>PISTON ID NO. NBD-10795 (7054)</p> <p>BCR \updownarrow 8.00</p> <p>OBSOLETE: NO LONGER AVAILABLE</p>	

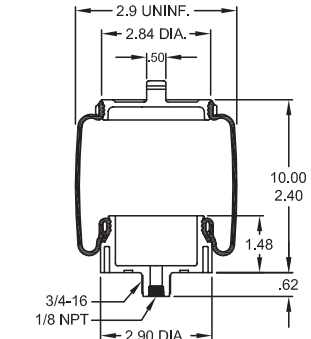
LOGO WHITE	AON W02-358-7061	0.70 Composite
	<p>APPLICATIONS: C. E. WHITE</p> <p>CAP ID NO. NBD-10409 (7042)</p> <p>PISTON ID NO. NBD-16538 (6913)</p> <p>BCR \updownarrow 8.00</p>	

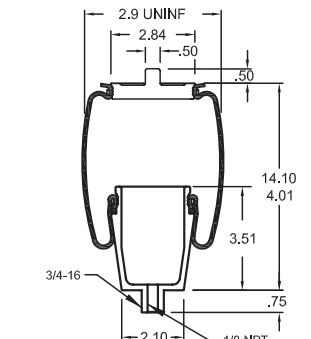
LOGO WHITE	AON W02-358-7074	0.92 Composite
	<p>APPLICATIONS: FREIGHTLINER LINK (1102-0047) LINK MANUFACTURING LTD 1102-0045 1102-0047 (FRT.)</p> <p>CAP ID NO. NBD-13262 (6997)</p> <p>PISTON ID NO. FIP-102216 (9638)</p> <p>BCR \updownarrow 10.12</p>	

LOGO WHITE	AON W02-358-7012	1.48 Aluminum
	<p>APPLICATIONS: LINK MANUFACTURING LTD 1102-0040 RIDE-RITE VANTAGE WHEEL CHAIR</p> <p>CAP ID NO. NBD-10010 (7007)</p> <p>PISTON ID NO. NBD-10071 (7023)</p> <p>BCR \updownarrow 10.87</p>	

LOGO WHITE	AON W02-358-7042	1.02 Composite
	<p>CAP ID NO. NBD-10239 (7015)</p> <p>PISTON ID NO. FIP-102217 (9636)</p> <p>BCR \updownarrow 10.87</p>	<p>APPLICATIONS: COMFORT RIDE</p>

LOGO WHITE	AON W02-358-7045	0.98 Composite
	<p>CAP ID NO. NBD-10409 (7042)</p> <p>PISTON ID NO. FIP-102216 (9638)</p> <p>BCR \updownarrow 10.87</p>	<p>APPLICATIONS: LINK MANUFACTURING LTD 1102-0042 (WESTERN STAR)</p> <p>OBSOLETE: NO LONGER AVAILABLE</p>

LOGO WHITE	AON W02-358-7056	1.00 Composite
	<p>CAP ID NO. NBD-13262 (6997)</p> <p>PISTON ID NO. FIP-102215 (9637)</p> <p>BCR \updownarrow 10.87</p>	<p>APPLICATIONS: LINK MANUFACTURING LTD 1102-0043 (FRT. KW, MACK)</p>

LOGO WHITE	AON W02-358-7208	0.94 Composite
	<p>CAP ID NO. FIP-100102 (6978)</p> <p>PISTON ID NO. FIP-102217 (9636)</p> <p>BCR \updownarrow 11.12</p>	<p>APPLICATIONS: SEATS 708015 (W02-812-7208)</p>

LOGO WHITE	AON W02-358-9904	3.89 Composite
	<p>CAP ID NO. NAD-25400 (7066)</p> <p>PISTON ID NO. NBD-15764 (6980)</p> <p>BCR \updownarrow 16.37</p>	<p>APPLICATIONS: LINK 1103-0504</p>

LOGO WHITE	AON W02-358-9901	3.16 Composite
	<p>CAP ID NO. NAD-25400 (7066)</p> <p>PISTON ID NO. NBD-11340 (7059)</p> <p>BCR \updownarrow 16.67</p>	<p>APPLICATIONS: PETERBILT 02-02031 FRONT AXLE AIR SPRING (PRODUCTION-1989 TO 1992)</p>

LOGO MAROON	AON W02-358-7017	1.54 Aluminum
	<p>CAP ID NO. NBD-10010 (7007)</p> <p>PISTON ID NO. NBD-10071 (7023)</p> <p>BCR \updownarrow 11.50</p>	<p>APPLICATIONS: MACK 227QS38</p>

LOGO YELLOW	AON W02-358-4003	1.01 Aluminum
	<p>CAP ID NO. NBD-10049 (7009)</p> <p>PISTON ID NO. NBD-10514 (7044)</p> <p>BCR \updownarrow 7.25</p>	<p>APPLICATIONS: COMFORT RIDE SEARS / DURAFORM S6197 (W02-811-4003)</p>

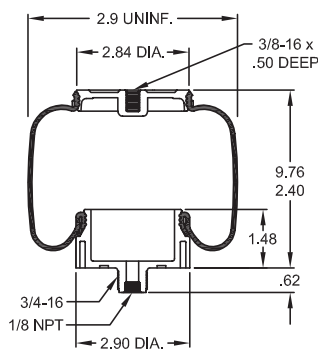
LOGO YELLOW	AON W02-358-7064	0.72 Composite
	<p>CAP ID NO. NBD-10218 (7018)</p> <p>PISTON ID NO. NBD-16538 (6913)</p> <p>BCR \updownarrow 7.75</p>	<p>APPLICATIONS: KENWORTH KW AEROCAB (MID 1999 & EARLIER) LINK (1102-0074) LINK MANUFACTURING LTD 1102-0074 (KW, MARMON)</p>

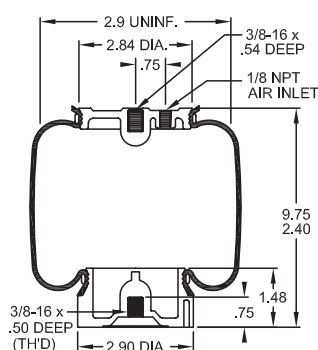
LOGO YELLOW	AON W02-358-7108	0.72 Composite
	<p>CAP ID NO. NBD-10470 (7068)</p> <p>PISTON ID NO. NBD-16537 (6912)</p> <p>BCR \updownarrow 7.75</p>	<p>APPLICATIONS: LINK MANUFACTURING LTD 1102-0075 (NAV.) MILSCO 07067A GY 1S5-057</p>

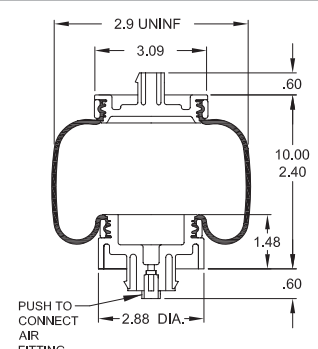
LOGO YELLOW	AON W02-358-7109	0.80 Composite
	<p>CAP ID NO. NBD-13706 (6990)</p> <p>PISTON ID NO. NBD-14218 (6894)</p> <p>BCR \updownarrow 7.87</p>	<p>APPLICATIONS: KENWORTH KW AEROCAB (MID 1999 & LATER) LINK (1102-0077) LINK MANUFACTURING LTD 1102-0077 (KW) T81-1000 KENWORTH</p>

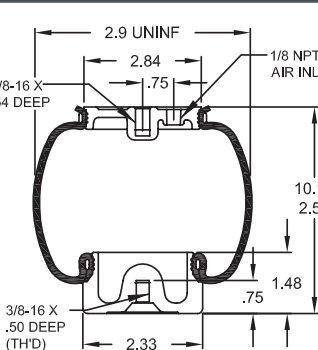
LOGO YELLOW	AON W02-358-7038	1.12 Aluminum
	<p>CAP ID NO. NBD-10183 (7013)</p> <p>PISTON ID NO. NBD-10795 (7054)</p> <p>BCR \updownarrow 8.00</p>	<p>APPLICATIONS: AIR FLEX 7048 AL (USE 7038) DONVEL</p>

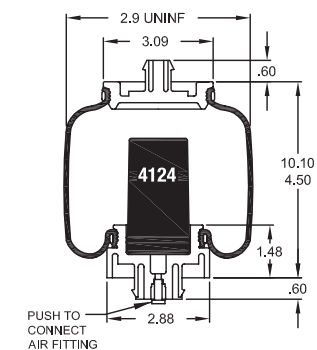
LOGO YELLOW	AON W02-358-7205	1.10 Composite
	<p>CAP ID NO. NBD-15430 (6987)</p> <p>PISTON ID NO. NBD-15431 (6986)</p> <p>BCR \updownarrow 8.00</p>	<p>APPLICATIONS: FREIGHTLINER / WESTERN STAR CONSTELLATION</p> <p>REPLACES W02-358-7203</p>

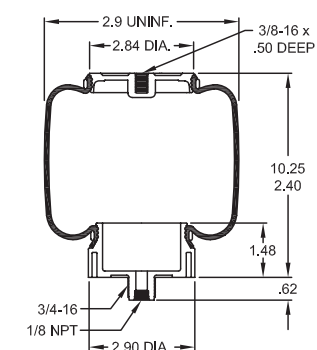
LOGO YELLOW	AON W02-358-7082	0.82 Composite
	<p>CAP ID NO. NBD-10218 (7018)</p> <p>PISTON ID NO. NBD-16538 (6913)</p> <p>BCR \updownarrow 8.25</p>	<p>APPLICATIONS: FREIGHTLINER / WESTERN STAR</p>

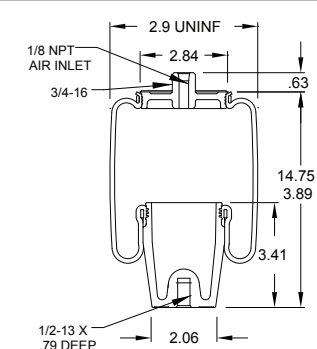
LOGO YELLOW	AON W02-358-7024	1.50 Aluminum
	<p>CAP ID NO. NBD-10010 (7007)</p> <p>PISTON ID NO. NBD-10071 (7023)</p> <p>BCR \updownarrow 10.00</p>	<p>APPLICATIONS: LINK MANUFACTURING LTD 1102-0071</p>

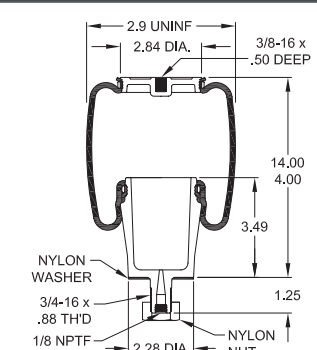
LOGO YELLOW	AON W02-358-7036	1.53 Aluminum
	<p>CAP ID NO. NBD-10082 (7014)</p> <p>PISTON ID NO. NBD-16484 (6906)</p> <p>BCR \updownarrow 10.00</p>	<p>APPLICATIONS: PETERBILT 29-03200 UNI-BUILT - HIGHWAY CAB/ SLEEPER 1993 & LATER UNI-BUILT FT SUPPORT SPRING 7155 PETERBILT T81-6000</p>

LOGO YELLOW	AON W02-358-7215	1.31 Composite
	<p>APPLICATIONS: FREIGHTLINER 18-40977-000 CENTURY CLASS ST</p> <p>CAP ID NO. NBD-15430 (6987)</p> <p>PISTON ID NO. NBD-15431 (6986)</p> <p>BCR ⇅ 10.43</p>	<p>REPLACES W02-358-7111</p>

LOGO YELLOW	AON W02-358-7151	1.30 Composite
	<p>APPLICATIONS: SEARS / DURAFORM S16894 PISTON ADAPTOR 7802/NBD 14989</p> <p>CAP ID NO. NBD-10470 (7068)</p> <p>PISTON ID NO. FIP-102217 (9636)</p> <p>BCR ⇅ 10.88</p>	<p>OBSOLETE: NO LONGER AVAILABLE</p>

LOGO YELLOW	AON W02-358-7014	1.52 Aluminum
	<p>APPLICATIONS:</p> <p>CAP ID NO. NBD-10010 (7007)</p> <p>PISTON ID NO. NBD-10071 (7023)</p> <p>BCR ⇅ 11.50</p>	

LOGO YELLOW	AON W02-358-7043	1.48 Aluminum
	<p>APPLICATIONS: DONVEL</p> <p>CAP ID NO. NBD-10183 (7013)</p> <p>PISTON ID NO. NBD-10071 (7023)</p> <p>BCR ⇅ 11.50</p>	<p>OBSOLETE: NO LONGER AVAILABLE</p>

LOGO YELLOW	AON W02-358-7081	0.92 Composite
	<p>APPLICATIONS: NAVISTAR LINK 1102-0076 LINK 1101-0043 GY 1S5-038 LINK MANUFACTURING LTD 1102-0076 (NAV.) NAVISTAR 2501300C1</p> <p>CAP ID NO. NBD-10604 (7050)</p> <p>PISTON ID NO. FIP-102217 (9636)</p> <p>BCR ⇅ 11.50</p>	

LOGO YELLOW	AON W02-358-7139	1.20 Aluminum
	<p>APPLICATIONS:</p> <p>CAP ID NO. NBD-10082 (7014)</p> <p>PISTON ID NO. NBD-16484 (6906)</p> <p>BCR ⇅ 11.50</p>	

LOGO BLUE	AON W02-358-7092	0.78 Composite
	<p>APPLICATIONS: KENWORTH KWCSA (LINK 1102-0083) LINK MANUFACTURING LTD 1102-0083 (KW)</p> <p>CAP ID NO. NBD-10218 (7018)</p> <p>PISTON ID NO. NBD-16538 (6913)</p> <p>BCR ⇅ 8.75</p>	

LOGO BLUE	AON W02-358-7093	1.45 Composite
	<p>APPLICATIONS: PETERBILT 29-06016 MODEL 387 (NEW IN 1999)</p> <p>CAP ID NO. NBD-14314 (6991)</p> <p>PISTON ID NO. NBD-14589 (6891)</p> <p>BCR ⇅ 10.00</p>	

