



BRAKE HARDWARE KITS FOR 12 1/4" DIAMETER BRAKES

BHK025



SPICER & STANDARD FORGE WITH CAST SHOES

QTY	PART #	DESCRIPTION
2	BH0044	RETURN SPRING
1	BH3036	LINK
2	BH3037	LOCK WASHER
2	BH3038	LOCK NUT
2	BH3039	BUSHING
2	BH3040	SET SCREW
2	BH6015	ROLLER - 1 1/4"
2	BH6016	ROLLER PIN
2	BH6042	ANCHOR PIN
2	BH3016	LOCK RING

REPLACES: CQ67397, E2030HD, K62, R507014

BHK035



EATON - SINGLE ANCHOR PIN BRAKE

QTY	PART #	DESCRIPTION
2	BH0027	RETURN SPRING
1	BH0039	RETURN SPRING
1	BH3029	LOCK WASHER
1	BH3031	LOCK NUT
2	BH6031	ROLLER - 1 1/2"
1	BH6037	ANCHOR PIN
2	CS3109	WASHER
1	CS3145	LOCK RING

REPLACES: 40A, CQ67388, E-2126, HK40, K106, R507000

BHK036



STANDARD FORGE WITH FABRICATED SHOES

QTY	PART #	DESCRIPTION
1	BH0014	RETURN SPRING
4	BH3009	WASHER
2	BH3015	SPRING PIN
2	BH3016	LOCK RING
4	BH3017	LOCK RING
2	BH3024	BUSHING
2	BH6017	ROLLER PIN
2	BH6018	ROLLER - 1 1/2"
2	BH6023	ANCHOR PIN

REPLACES: 12A, 43A, CQ67398, E2402HD, HK43XLS, K69, K71, K98, M12LK101X, R507015

BRAKE HARDWARE KITS FOR 12 1/4" DIAMETER BRAKES



BHK036-1



CONVERT STANDARD FORGE CAST SHOE TO FABRICATED SHOES

QTY	PART #	DESCRIPTION
1	BH0014	RETURN SPRING
2	BH3015	SPRING PIN
2	BH3016	LOCK RING
2	BH3017	LOCK RING
2	BH3037	LOCK WASHER
2	BH3038	LOCK NUT
2	BH3041	LINK
2	BH6017	ROLLER PIN
2	BH6018	ROLLER - 1 1/2"
2	BH6043	ANCHOR PIN

REPLACES: 45A, CQ67503, E2403HD, HK45XLS, K-50, R507068

BHK041



FRUEHAUF "PROPAR" BRAKE

QTY	PART #	DESCRIPTION
1	BH0019	RETURN SPRING
2	BH3001	SPRING PIN
2	BH3019	BUSHING
2	BH3030	LOCK PIN
2	BH3042	RETAINER
2	BH6028	ROLLER - 1"
2	BH6034	ANCHOR PIN

REPLACES: 41A, CQ67394, E-2286, HK41, K105, R507005

BHK043



MERITOR "Q" BRAKE

QTY	PART #	DESCRIPTION
2	BH0002	RETAINER SPRING
1	BH0018	RETURN SPRING
2	BH3001	SPRING PIN
2	BH3002	BUSHING
4	BH3016	LOCK RING
2	BH6001	ANCHOR PIN
2	BH6021	ROLLER - 1 1/2"
2	BH6022	ROLLER PIN

REPLACES: 44A, CQ67395, E-3484, HK44XLS, K-154, KIT8004, R508004

BHK044

SPICER (DANA) NEW STYLE "U" BRAKE
FC SERIES

QTY	PART #	DESCRIPTION
1	BH0014	RETURN SPRING
1	BH0029	RETAINER SPRING
2	BH3001	SPRING PIN
2	BH3005	RETAINER
2	BH6000	ROLLER - 1 1/4"
2	BH6030	ANCHOR PIN



Old Style Cam

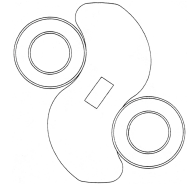

Head Marking
M12L and M12R

REPLACES: 47A, CQ69002, E-3782, HK47XLS-125, K279,
R507076



BHK044-1

SPICER (DANA) NEW STYLE "U" BRAKE
FC SERIES

QTY	PART #	DESCRIPTION
1	BH0014	RETURN SPRING
1	BH0029	RETAINER SPRING
2	BH3001	SPRING PIN
2	BH3005	RETAINER
2	BH6011	ROLLER - 1 1/2"
2	BH6030	ANCHOR PIN



New Style Cam

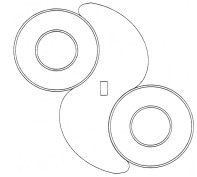

Head Marking
0794L and 0794R
as of July 1999

REPLACES: 47B, CQ69006, E-9283, HK47XLS-150,
K336, R507090

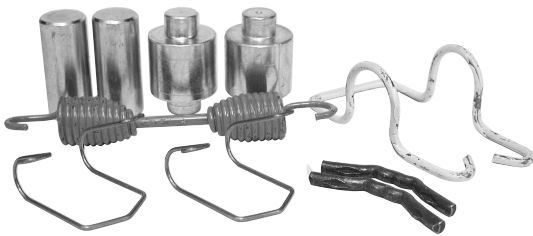

BHK068

DEXTER "PQ" BRAKE

QTY	PART #	DESCRIPTION
2	BH0002	RETAINER SPRING
1	BH0014	RETURN SPRING
2	BH3001	SPRING PIN
2	BH3006	BUSHING
4	BH3016	LOCK
2	BH6001	ANCHOR PIN
2	BH6017	ROLLER PIN
2	BH6018	ROLLER - 1 1/2"



New Style Cam

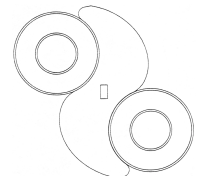

Head Marking
0794L and 0794R
as of July 1999

REPLACES: E-10875, K369, R507095



BRAKE HARDWARE KITS FOR 12 1/4" DIAMETER BRAKES



BHK071



SPICER (DANA) FT WITH FABRICATED SHOE (FOR USE WITH OLD STYLE "FAST-RISE" CAMSHAFT ONLY)

QTY	PART #	DESCRIPTION
1	BH0014	RETURN SPRING
2	BH3001	SPRING PIN
2	BH3005	RETAINER
4	BH3009	WASHER
4	BH3017	LOCK RING
2	BH3024	BUSHING
2	BH6000	ROLLER - 1 1/4"
2	BH6023	ANCHOR PIN

REPLACES: 48A, CQ67403, E-3373HD, HK48XLS-125, K277, R507074

BHK088



RETRO-FITS SPIDERS W/1" ANCHOR PIN TO FC-III SHOE (PRE 11/1/96)

QTY	PART #	DESCRIPTION
2	BH0002	RETAINER SPRING
1	BH0014	RETURN SPRING
2	BH3001	SPRING PIN
2	BH3005	RETAINER
4	BH3009	WASHER
4	BH3017	LOCK RING
2	BH3024	BUSHING
2	BH6011	ROLLER - 1 1/2"
2	BH6023	ANCHOR PIN



New Style Cam

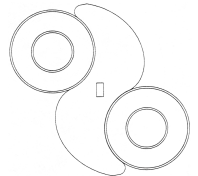

Head Marking
0794L and 0794R
as of July 1999

REPLACES: E-10757, K377, M12KBH10, R507093

BHK088-1



SPECIAL KIT CONTAINS 1" AND 1-1/4" ANCHOR PINS FOR USE WITH HIGH PROFILE CAMSHAFT ONLY

QTY	PART #	DESCRIPTION
2	BH0008	RETAINER SPRING
1	BH0014	RETURN SPRING
2	BH6001	ANCHOR PIN
2	BH6023	ANCHOR PIN
2	BH3001	SPRING PIN
2	BH6011	ROLLER - 1 1/2"
2	BH3002	BUSHING
4	BH3017	LOCK RING
4	BH3009	WASHER
2	BH3005	RETAINER

REPLACES: HK49-150



BRAKE HARDWARE KITS FOR 12 1/4" DIAMETER BRAKES

BHK096

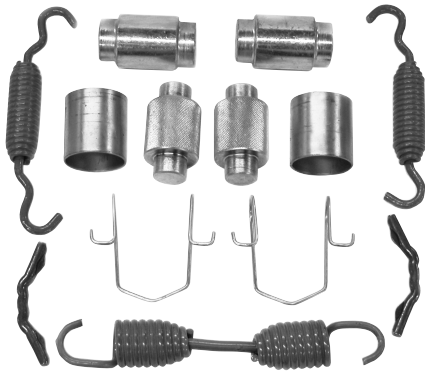

DEXTER WITH 1-1/4" ANCHOR PIN AND ROLLER

QTY	PART #	DESCRIPTION
2	BH0002	RETAINER SPRING
1	BH0014	RETURN SPRING
2	BH6001	ANCHOR PIN
2	BH3001	SPRING PIN
2	BH6000	ROLLER - 1 1/4"
2	BH3002	BUSHING
2	BH3005	RETAINER

REPLACES: 08-104800, K-353

BHK1001

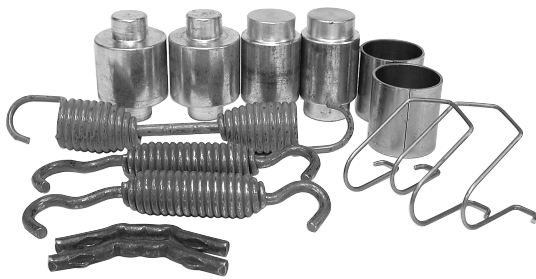

SPICER (DANA) FC-III TRAILER AXLE (POST 11/1/96 SPIDER)

QTY	PART #	DESCRIPTION
2	BH0002	RETAINER SPRING
1	BH0014	RETURN SPRING
2	BH3001	SPRING PIN
2	BH3002	BUSHING
2	BH3005	RETAINER
2	BH6001	ANCHOR PIN
2	BH6011	ROLLER - 1 1/2"

REPLACES: E-10756, K373, M12KBH11, R507092



FOR 15" DIAMETER BRAKES

BHK006



MERITOR "T" SERIES FRONT BRAKE

QTY	PART #	DESCRIPTION
1	BH0016	RETURN SPRING
1	BH3021	HOLD DOWN ASSEMBLY (INCLUDES 4 CUPS, 4 SPRINGS 4 WASHERS AND 4 PINS)
2	BH3023	WASHER
2	BH3027	LOCK NUT
2	BH6019	ROLLER - 1 1/4"
2	BH6024	ANCHOR PIN
2	CS3140	LOCK RING

REPLACES: CQ66919, E-4691, HK51, K260, KIT9094, R509094

BRAKE HARDWARE KITS FOR 15" DIAMETER BRAKES



BHK006M



MERITOR "T" SERIES FRONT BRAKE (MINOR KIT)

QTY	PART #	DESCRIPTION
1	BH0016	RETURN SPRING
1	BH3021	HOLD DOWN ASSEMBLY (INCLUDES 4 CUPS, 4 SPRINGS 4 WASHERS AND 4 PINS)
2	BH6019	ROLLER - 1 1/4"
2	CS3140	LOCK RING

REPLACES: CQ69003, E-6879, HK50, K-265, KIT1125

BHK008



WAGNER FRONT BRAKE

QTY	PART #	DESCRIPTION
1	BH0021	RETURN SPRING
2	BH3025	LOCK RING
4	BH3026	WASHER KIT
2	BH3027	LOCK NUT
2	BH6019	ROLLER - 1 1/4"
2	BH6026	ANCHOR PIN

REPLACES: 53-1A, CQ66926, E-3291, F97506, HK53, K-134, R507073

BHK009



EATON "EB" AND "ES" SERIES

QTY	PART #	DESCRIPTION
1	BH0026	RETAINER SPRING
1	BH0025	RETURN SPRING
2	BH6019	ROLLER - 1 1/4"

REPLACES: 5-2242, 54A, 1008306, CQ66917, E-5139, HK54, K263, R507004



BRAKE HARDWARE KITS FOR 15" DIAMETER BRAKES

BHK010

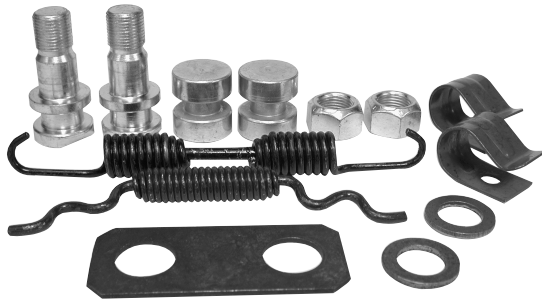

MERITOR "Q" FRONT BRAKE

QTY	PART #	DESCRIPTION
1	BH0023	RETURN SPRING
1	BH0028	RETAINER SPRING
2	BH3022	WASHER
2	BH3027	LOCK NUT
2	BH3032	CLIP
1	BH3034	LINK PLATE
2	BH6019	ROLLER - 1 1/4"
2	BH6027	ANCHOR PIN

REPLACES: 55A, E-3869, CQ69001, HK55, K283, KIT8029, R508029

BHK010M



MERITOR "Q" FRONT BRAKE (MINOR KIT)

QTY	PART #	DESCRIPTION
1	BH0023	RETURN SPRING
1	BH0026	RETAINER SPRING
2	BH3032	CLIP
2	BH6019	ROLLER - 1 1/4"

REPLACES: CQ67899, E-7899, HK77, K282, R508030

BHK045



BENDIX FRONT AXLE BRAKE

QTY	PART #	DESCRIPTION
1	BH0035	RETURN SPRING
2	BH0036	RETAINER SPRING
2	BH6032	ROLLER PIN
2	BH6033	ROLLER - 1 1/2"
1	BH6035	ANCHOR PIN

REPLACES: 70A, CQ65519, E-7231, HK70, K297, R507080

BRAKE HARDWARE KITS FOR 15" DIAMETER BRAKES



BHK059

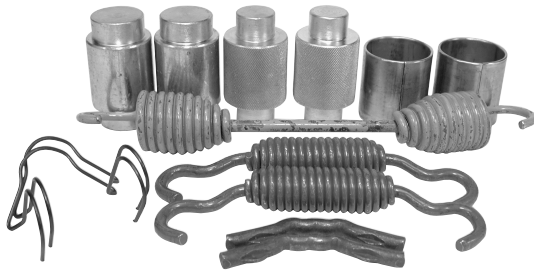

MERITOR "Q PLUS" FRONT AND DRIVE AXLE BRAKE

QTY	PART #	DESCRIPTION
2	BH0002	RETAINER SPRING
1	BH0041	RETURN SPRING
2	BH3000	ROLLER RETAINER
2	BH3001	RETURN SPRING PIN
2	BH3006	ANCHOR PIN BUSHING
2	BH6000	ROLLER - 1 1/4"
2	BH6001	ANCHOR PIN

REPLACES: 66A, CQ65642, E-9064, HK66XLS, K318, KIT8824HD, R508824

BHK074

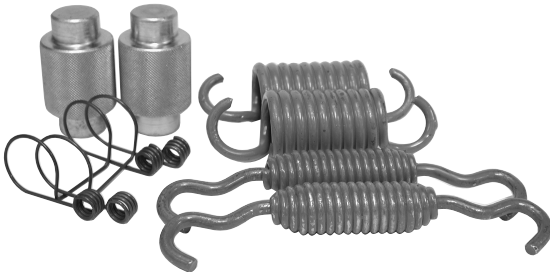

EATON "ES" & "ES II" REDUCED ENVELOPE FRONT BRAKE

QTY	PART #	DESCRIPTION
2	BH0002	RETAINER SPRING
2	BH0030	RETURN SPRING
2	BH3003	ROLLER RETAINER
2	BH6005	ROLLER - 1 1/4"

REPLACES: 90A, 122A, 5-2242, 823141, 1008306, CQ66947, E-9141, HK90XLS, K356, R507086

NOTE:  Use with horse collar

BHK075

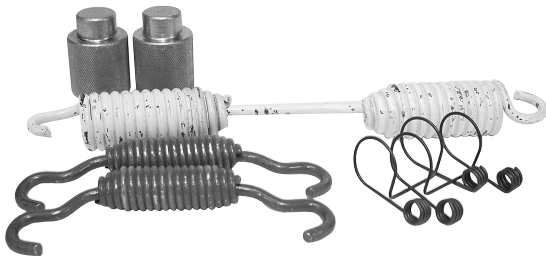

EATON 15X8-5/8" - "ES" AND "ES II" REDUCED ENVELOPE BRAKE DRIVE AXLE

QTY	PART #	DESCRIPTION
2	BH0002	RETAINER
1	BH0031	RETURN SPRING
2	BH3003	ROLLER RETAINER
2	BH6005	ROLLER - 1 1/4"

REPLACES: 91A, 815626, CQ66948, E-9039, HK91XLS, K350, R507083

BHK116

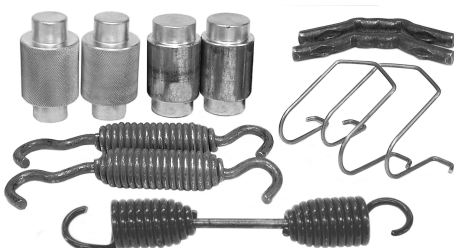

INGERSOL AXLE

QTY	PART #	DESCRIPTION
2	BH0002	RETAINER SPRING
1	INCLUDED	RETURN SPRING
2	BH6001	ANCHOR PIN
2	BH3001	SPRING PIN
2	BH6000	ROLLER - 1 1/4"
2	BH3005	RETAINER

BHK001

UNIVERSAL KIT (STANDARD)



QTY	PART #	DESCRIPTION
1	BH0010	RETURN SPRING
2	BH3001	SPRING PIN
2	BH3002	BUSHING
2	BH3005	RETAINER
2	BH6000	ROLLER - 1 1/4"
2	BH6025	ANCHOR PIN
4	CS3102	WASHER
4	CS3140	LOCK RING

REPLACES: 5-2239, 14A, 14-2A, 14-3A, 14-4A, CQ66735, E1816HD, E1816SHD, HK14XLS, , K-45, K-116, KIT9001, KIT9017HD, KIT9017NHD, R509001

BHK001R

MERITOR "P" AND EARLY STANDARD FORGE BRAKE



QTY	PART #	DESCRIPTION
1	BH0010	RETURN SPRING
2	BH3001	SPRING PIN
2	BH3005	RETAINER
4	BH3007	SEAL
2	BH6000	ROLLER - 1 1/4"
2	BH6020	ANCHOR PIN
2	CS3012	LOCK SCREW
4	CS3140	LOCK RING

REPLACES 16A, CQ67390, HK16XLS, K44B, K115, KIT 4, KIT 4A, KIT 4S, KIT4SHD, M16LK104X

BHK003

EATON SINGLE ANCHOR PIN AND BRAKE



QTY	PART #	DESCRIPTION
1	BH0003	RETURN SPRING
2	BH0004	RETAINER SPRING
2	BH6003	ROLLER PIN
2	BH6004	ROLLER - 1 5/8"

REPLACES: 5-2243, 1001238, 24-1A, 24-1SS, CQ67319, E-1875HD, HK24XLSHM, K-42, K-119, R507002

BRAKE HARDWARE KITS FOR 16 1/2" DIAMETER BRAKES



BHK019



BENDIX TRUCK AND TRACTOR BRAKE

QTY	PART #	DESCRIPTION
1	BH0037	RETURN SPRING
2	BH0038	RETAINER SPRING
2	BH3001	RETURN SPRING PIN
2	BH3028	BUSHING
2	BH6032	ROLLER - 1"
2	BH6033	ROLLER - 1 1/2"
2	BH6036	ANCHOR PIN

REPLACES: 71A, CQ65520, E-7237, HK71, K299, R507081

BHK019S

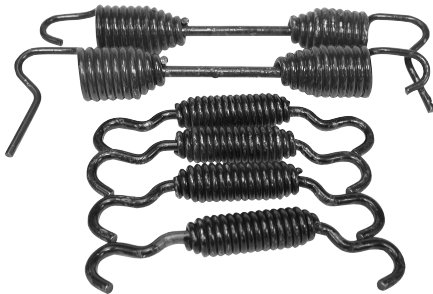

BENDIX TRUCK AND TRACTOR BRAKE - SPRING KIT

QTY	PART #	DESCRIPTION
2	BH0037	RETURN SPRING
4	BH0038	RETAINER SPRING

REPLACES: E-7238, R507082

SERVICES ONE AXLE

BHK020

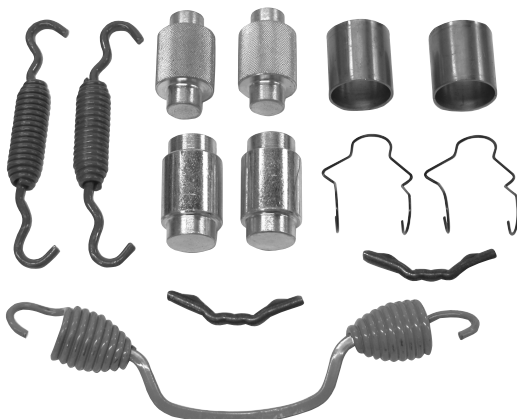

MERITOR FRONT BRAKE.

IMPORTANT NOTE: SPRING MUST BE INSTALLED WITH END HOOK OPEN TOWARD CAMSHAFT HEAD

QTY	PART #	DESCRIPTION
2	BH0002	RETAINER SPRING
1	BH0022	RETURN SPRING
2	BH3001	RETURN SPRING PIN
2	BH3002	ANCHOR PIN BUSHING
2	BH3005	RETAINER
2	BH6000	ROLLER - 1 1/4"
2	BH6001	ANCHOR PIN

REPLACES: 81A, CQ66887, E-9644, HK81XLS, K334, KIT8053, KIT8081



BRAKE HARDWARE KITS FOR 16 1/2" DIAMETER BRAKES

BHK022

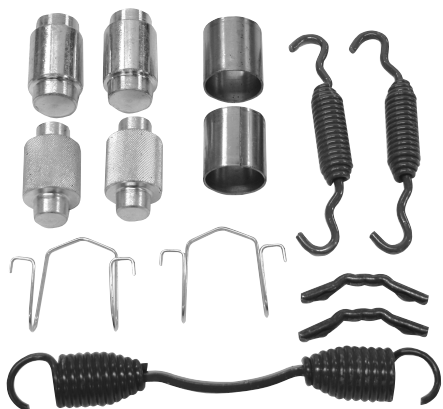

MERITOR "Q" FRONT BRAKE "FH" AND "FL" AXLE

QTY	PART #	DESCRIPTION
2	BH0002	RETAINER SPRING
1	BH0015	RETURN SPRING
2	BH3001	SPRING PIN
2	BH3002	BUSHING
2	BH3005	RETAINER
2	BH6000	ROLLER - 1 1/4"
2	BH6001	ANCHOR PIN

REPLACES: 80A, CQ66889, E-9070, HK80XLS, K366, KIT8037

BHK024

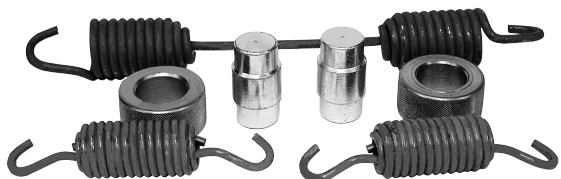

EATON SINGLE ANCHOR PIN BRAKE - FORD

QTY	PART #	DESCRIPTION
2	BH0004	RETAINER SPRING
1	BH0012	RETURN SPRING
2	BH6003	ROLLER - 59/64"
2	BH6004	ROLLER - 1 5/8"

REPLACES: 1008403, 24-1AF, 5-3690, CQ69004, E-3801, HK24XLSHM, K316, R507077

BHK047



EATON RETRO-FIT FOR MERITOR "Q"

QTY	PART #	DESCRIPTION
1	BH0010	RETURN SPRING
2	BH0002	RETAINER SPRING
2	BH3001	SPRING PIN
2	BH3003	RETAINER
2	BH3006	BUSHING
2	BH6000	ROLLER - 1 1/4"
2	BH6001	ANCHOR PIN

REPLACES: 5-3319, 67A, CQ65479, E-8925, HK67XLS, K322, R507062

BRAKE HARDWARE KITS FOR 16 1/2" DIAMETER BRAKES



BHK048

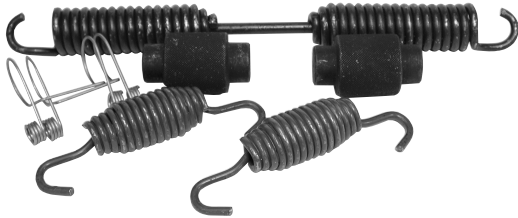

EATON "ES" EXTENDED SERVICE BRAKE
(USE ONLY WITH "ES" CAMSHAFT)

QTY	PART #	DESCRIPTION
2	BH0004	RETAINER SPRING
1	BH0006	RETURN SPRING
2	BH3003	ROLLER RETAINER
2	BH6005	ROLLER - 1 1/4"

REPLACES: 63A, 808330, CQ65481, E-5481A, K295, R507057

BHK051



"Q", "Q-PLUS", "FC", "XLII", "INTRAAX" BRAKES

QTY	PART #	DESCRIPTION
1	BH0001	RETURN SPRING - 8-3/8"
2	BH0002	RETAINER SPRING
2	BH3000	ROLLER RETAINER
2	BH3001	RETURN SPRING PIN
2	BH3002	BUSHING
2	BH6000	ROLLER - 1 1/4"
2	BH6001	ANCHOR PIN

REPLACES: 29-1A, 29-1AC, 29-1AR, 29-1ARC, CQ66867,
E-2769SHD, HK29XLS, K329, K332, KIT8000HD

NOTE: Minor kit BHK5152M also available, see page 15

BHK051-8

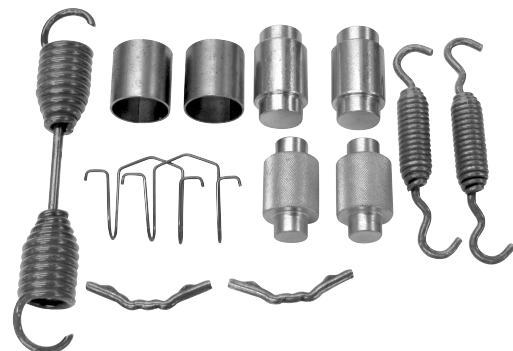

"Q", "Q-PLUS", "FC", "XLII", "INTRAAX" BRAKES

QTY	PART #	DESCRIPTION
1	BH0010	RETURN SPRING - 8"
2	BH0002	RETAINER SPRING
2	BH3005	ROLLER RETAINER (OLD STYLE)
2	BH3001	RETURN SPRING PIN
2	BH3002	BUSHING
2	BH6000	ROLLER
2	BH6001	ANCHOR PIN

REPLACES: E-2769SHD-C

NOTE: Same as BHK051 except 8" return spring and old type roller retainer

BHK052

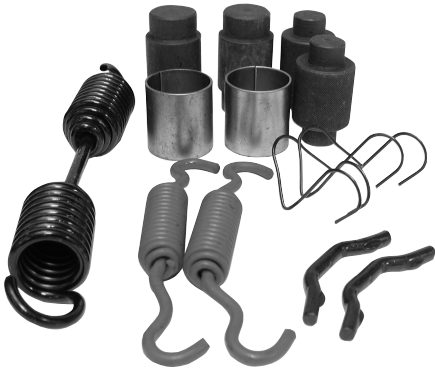

FRUEHAUF "PROPAR" "XEM" STANDARD BRAKE

QTY	PART #	DESCRIPTION
1	BH0001	RETURN SPRING
2	BH0002	RETAINER SPRING
2	BH3000	ROLLER RETAINER
2	BH3001	SPRING PIN
2	BH3002	BUSHING
2	BH6000	ROLLER - 1 1/4"
2	BH6002	ANCHOR PIN

REPLACES: 34A, 34-1A, 34-2A, 34-2AC, 34-1AC, CQ66914, E-3710SHD, HK34XLS, K330, R507010

BHK055



SPICER (DANA) "XL" XTRA-LIFE BRAKE
(USE ONLY WITH SPICER XL CAMSHAFT)

QTY	PART #	DESCRIPTION
2	BH0002	RETAINER SPRING
1	BH0001	RETURN SPRING
2	BH3001	SPRING PIN
2	BH3002	BUSHING
2	BH3005	RETAINER
2	BH6001	ANCHOR PIN
2	BH6028	ROLLER - 1"

REPLACES: 29XL, CQ65515, E-5515, HK32SD, K305, R507063

BHK056



EATON RETRO-FIT FOR FRUEHAUF "XEM"

QTY	PART #	DESCRIPTION
1	BH0010	RETURN SPRING
2	BH0002	RETAINER SPRING
2	BH3001	SPRING PIN
2	BH3003	RETAINER
2	BH3006	BUSHING
2	BH6000	ROLLER - 1 1/4"
2	BH6002	ANCHOR PIN

REPLACES: 5-3321, 65A, CQ65478, E-8923, HK65SD, K136, R507061

BRAKE HARDWARE KITS FOR 16 1/2" DIAMETER BRAKES



BHK077

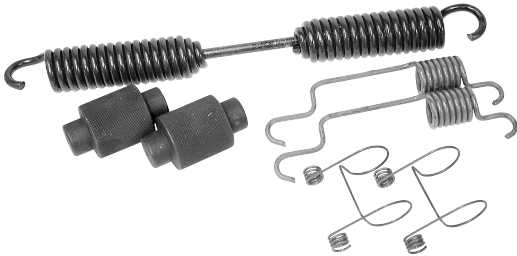

EATON "ES-II" EXTENDED SERVICE BRAKE
IMPORTANT NOTE: INSTALL RETAINER SPRING WITH COIL END UP. CAN ONLY BE USED WITH EATON "ES" CAMSHAFTS.

QTY	PART #	DESCRIPTION
1	BH0006	RETURN SPRING
2	BH0007	RETURN SPRING
2	BH3003	ROLLER RETAINER
2	BH6005	ROLLER - 1 1/4"

REPLACES: 314147, E-10244/S, K-375, R507064, CQ65477

BHK078

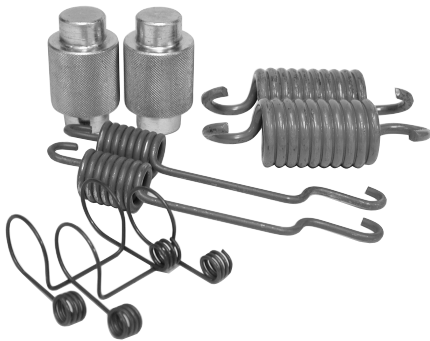

EATON "ES-II" "EXTENDED SERVICE" FRONT AXLE BRAKE
(USE ONLY WITH "ESII" CAMSHAFT)

QTY	PART #	DESCRIPTION
2	BH0007	RETAINER SPRING
2	BH0030	RETURN SPRING
2	BH3003	RETAINER
2	BH6005	ROLLER - 1 1/4"

REPLACES: 63-2A, 314146, CQ65446, E-10760, HK62, K376, R507094

NOTE:  Use with horse collar

BHK5152M



MINOR KIT FOR "Q", "Q-PLUS", "FC", "XLII", "INTRAAX" BRAKES

QTY	PART #	DESCRIPTION
2	BH3001	RETURN SPRING PIN 8-3/8"
2	BH6000	ROLLER - 1 1/4"
2	BH3000	RETAINER
1	BH0001	RETURN SPRING
2	BH0002	RETAINER SPRING

REPLACES: 38-A, 38-AC, 38-ARC, CQ6867, E-3895SHD, HK38XLS, KIT8014



BRAKE HARDWARE KITS FOR 18" DIAMETER BRAKES

BHK016



MERITOR BRAKE WITH CAST SHOES (NEW STYLE)

QTY	PART #	DESCRIPTION
1	BH0024	RETURN SPRING
4	BH3007	SEAL
2	BH3011	ANCHOR PIN
2	BH3012	LOCK SCREW
4	CS3010	BUSHING
2	BH3013	BUSHING
2	BH6014	ROLLER - 1 5/8"
4	CS3140	LOCK RING

REPLACES: CQ67408, E-3992, HK76, K281, R509408

BHK023



EATON SINGLE ANCHOR PIN BRAKE - CAST SHOES

QTY	PART #	DESCRIPTION
2	BH0032	RETAINER SPRING
1	BH0034	RETURN SPRING
2	BH6029	ROLLER - 59/64"
2	BH6044	ROLLER - 1 5/8"

REPLACES: 26A, 1005006, CQ67406, E-2821, HK26, K275, R507072

BHK1003



MERITOR BRAKE WITH CAST SHOES (OLD STYLE)

QTY	PART #	DESCRIPTION
1	BH0017	RETURN SPRING
4	BH3007	SEAL
4	BH3010	BUSHING
2	BH3011	ANCHOR PIN
2	BH3012	LOCK SCREW
2	BH3014	RETURN SPRING PIN
2	BH6014	ROLLER - 1 5/8"
4	CS3140	LOCK RING

REPLACES: 68A, CQ67407, E3518, HK68, K274, KIT9081, KIT9179

TRANSIT BRAKE HARDWARE KITS

FOR 14 1/2" DIAMETER BRAKES



BHK801



ONLY SOLD AS KIT

MERITOR "W" SERIES COACH BRAKE - STEER AXLE

QTY	DESCRIPTION
2	ANCHOR PIN
2	FITTING
1	LOCK WASHER
1	LOCK SCREW
2	ROLLER
2	SPRING
1	WASHER

REPLACES: E-10841, KIT6004, HK87

BHK801M

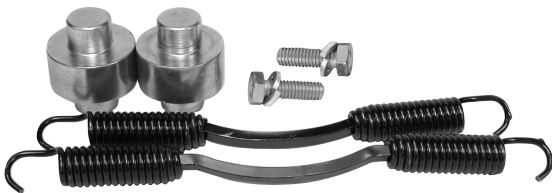

ONLY SOLD AS KIT

MERITOR "W" SERIES COACH BRAKE - STEER AXLE

QTY	DESCRIPTION
2	LOCK SCREW
2	ROLLER
2	SPRING
2	WASHER

REPLACES: E-10866, HK86

BHK805



ONLY SOLD AS KIT

MERITOR "W" SERIES COACH BRAKE - DRIVE AXLE

QTY	DESCRIPTION
2	ANCHOR PIN
2	BUSHING
4	LOCK RING
2	LOCK SCREW
2	ROLLER
1	SPRING

REPLACES: E-10870, HK84, KIT6003



BRAKE HARDWARE KIT COMPONENTS

BRAKE SHOE ROLLERS

BH6031



For Eaton 12-1/4" S.A.P. Truck Brake

Overall length 2"
Length/Large Diam. 7/8"
O.D. 1-1/2"

Replaces: 32-1429, 820165, C66650, E-1406, L1600, R517005

BH6000



For 12-1/4", 15 & 16-1/2" Brake

Overall length 2-7/32"
Length/Large Diam. 1-9/32"
O.D. 1-1/4"

Replaces: 32-1428, 2297-T-2222, C66901, E-2177, L1533

BH6005

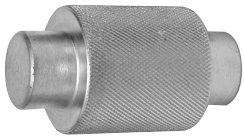

For Eaton 15" and 16-1/2" "ES" Brake

Overall length 2-5/32"
Length/Large Diam. 1-1/4"
O.D. 1-1/4"

Replaces: 32-1471, E-5477, L2960

BH6004



For Eaton 16-1/2" Truck Brake
Use Pin BH6003

Overall length 25/32"
O.D. 1-5/8"
I.D. 15/16"

Replaces: 32-1441A, C66902, E-2217A/S, L1534, R517006

BH6011



For 12-1/4" Spicer Brake

Overall length 2-7/32"
Length/Large Diam. 1-9/32"
O.D. 1-1/2"

Replaces: 32-1427, 1779-D-82, C65470, E-586, L158

BH6015



For 12-1/4" Spicer Shoes
Use Pin BH6016

Overall length 1"
O.D. 1-1/4"
I.D. 3/4"

Replaces: 32-1435, 1199-A-625, C65300, E-500, L100

BH6028



For Fruehauf "Propar" 12-1/4" Brake
 and Spicer "Xtralife" Brake

Overall length 2-7/32"
Length/Large Diam. 1-1/4"
O.D. 1"

Replaces: 32-1430, C67447, E-1582, L1696, R517002

BH6044



For Eaton 18" x 7" Cast Shoes
Use Pin BH6029

Overall length 1-1/4"
O.D. 1-5/8"
I.D. 15/16"

Replaces: 32-1443, 1003831, C66608, E-2802, L1622

BH6014

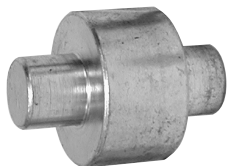

For Meritor 18" x 7" Cast Shoe

Overall length 2-13/16"
Length/Large Diam. 15/16"
O.D. 1-5/8"

Replaces: 32-1458, 1199-U-3765, C66610, E-3511, L1646

BH6018



For Spicer 12-1/4" Shoes & Dexter
 12-1/4" "PQ" Brakes after 5/96
Use Pin BH6017

Overall length 1-3/8"
O.D. 1-1/2"
I.D. 3/4"

Replaces: 32-1445, 204108-001, C67490, E-2395, L1280, R517003

BRAKE HARDWARE KIT COMPONENTS

BRAKE SHOE ROLLERS / ROLLER PINS / RETAINERS



BH6021



For Meritor 12-1/4" "Q" Brake
Use with BH6022

Overall length 1-7/16"
O.D. 1-1/2"
I.D. 3/4"

Replaces: 32-1467, 2297-C-5021,
C67466, E-3483, L2352

BH6022



For Meritor 12-1/4" "Q" Brake
Use with BH6021 Roller

O.D. 3/4"
Length 2-13/32"

Replaces: 32-1468, 1246-F-1020, C67467, E-3482, L2353

BH6033



For Bendix 15" x 16-1/2" Brakes
Use with pin BH6032

Overall length 1-7/16"
O.D. 1-1/2"
I.D. 1-1/32"

Replaces: 32-1479, L2983

BH6003

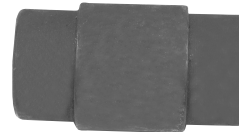

For Eaton 16-1/2" Brake
Use with BH6004

Overall length 1-25/32"
O.D. 59/64"

Replaces: 32-1442A, 39075, C65431, E-596A, L251, R517509

ROLLERS FOR SINGLE WEB SHOES

BH6019



For Meritor "T", Eaton and Wagner
15" x 4" Brake

Overall length 1-3/8"
O.D. 1-1/4"
Groove Width 3/8"

Replaces: 32-1464, 1199-G-3725,
80433, C66834, E-3421A,
L2811

BH6032



For Bendix 15" x 16-1/2" Brakes
Use with BH6033

Overall length 2-1/4"
O.D. 1"

Replaces: 32-1480, L2984

BRAKE SHOE ROLLER PINS

BH6016



Use with BH6015 Roller

O.D. 3/4"
Length 2-1/4"

Replaces: 32-1440, 1246-G-475, 1246-S-227, C65301, E-501, L101

BH6029



For Eaton 18" x7" Brake
Use with BH6044

Overall length 2-5/32"
O.D. 59/64"

Replaces: 32-1444, 1003832, C66609, E-2803, L1623

ROLLER RETAINERS

BH6017



For 12-1/4" Std. Forge & Dexter "PQ"
Brake after 5/96.
Use with BH6018 Roller

O.D. 3/4"
Length 2-1/4"

Replaces: 32-1446, 205107-001, C67487, E-2396, L1281, R517506

BH3003



For Eaton "ES" & "ES-II" 16-1/2"
and "ES" 15" Brake

Replaces: 34-1570, 808058,
C63001, E-5478, L2961



BRAKE HARDWARE KIT COMPONENTS

ROLLER RETAINERS / BRAKE SHOE ANCHOR PINS

BH3042



For Fruehauf 12-1/4" Brake

Length --

Replaces: 34-1531, ACD2233-1, C67448, E-1581, L1697, R527001

BH3000

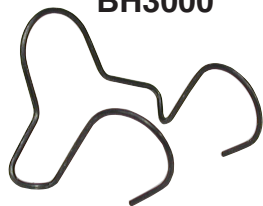

For multiapplications

Length 1-7/8"

Replaces: 34-1532, 3105-B-210, C66903, E-3007A, L1537

BH3005



For multiapplications
Use with BH6000, BH6010, BH6011, BH6013 Pins

Length 2-9/32"

Replaces: 34-1529, 1718-Y-103, C65327, E-539, L151

BRAKE SHOE ANCHOR PINS

BH6024



For Meritor 15" x 4" "T" Brake

O.D. 13/16"
Length 2-3/4"

Replaces: 15-550, 1259-B-262, C66841, L1736

BH6027



For Meritor 15" x 4" "Q" Brake

O.D. 13/16"
Length 2-11/16"

Replaces: 15-562, 1259-X-1012, C69611, L2930

BH6026



For Wagner 15" x 4" Brake

O.D. 13/16"
Length 3-5/16"

Replaces: 15-557, 80414, C66879

BH6030



For Spicer 12-1/4" "U" Brake

O.D. 1"
Length 2-1/4"

Replaces: 15-545, 203113-001, C67489, E-5304, L2368

BH6023



For Spicer 12-1/4", Std. Forge/Dexter Brake

O.D. 1"
Length 2-3/4"

Replaces: 15-537, 203108-001, C67473, E-2390, L1368, R537001

BH6042



For multiapplications

O.D. 1"
Length 6-9/32"

Replaces: 15-538, E-2029, L728, R537006

BH6036



For Bendix 16-1/2" Truck & Tractor Brake

O.D.L. 1-1/8"
O.D.S. 31/32"
Length 2-1/4"

Replaces: 15-564, L2996

BH6001



For multiapplications

O.D.L. 1-1/4"
O.D.S. 1"
Length 2-7/32"

Replaces: 1259-N-274, 15-542, C66866, E-2766, L1416

BH6002



For Late Model Fruehauf "XEM"

O.D.L. 1-1/4"
O.D.S. 1-1/16"
Length 2-3/8"

Replaces: 15-536, ACF3378-001, C66915, E-3711/S, L2364, R537005

BRAKE HARDWARE KIT COMPONENTS

BRAKE SHOE ANCHOR PINS / RETAINER SPRINGS



BH6034

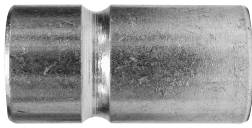

For Fruehauf with Offset Lock Pin

O.D. 1-1/4"
Length 2-15/32"

Replaces: 15-529, 1259-N-170, C65344, L238

BH6035



For Bendix 15" Brake

Length/Large Diam. 1-1/2"
O.D. 1-5/16"
Overall Length 2-1/4"

Replaces: 15-563, L2987

BH6025

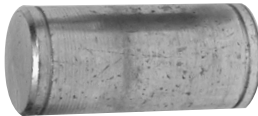

For floating type

O.D. 1-1/4"
Length 2-3/4"

Replaces: 15-527, 1259-J-218, C65369, E-1112S, L788

BH6012



For Mack Shoe

Length/Large Diam. 1-1/2"
O.D. 1-5/8"
Overall Length 2-17/62"

Replaces: 32-1431, 1199-A-3719, C67366, E-2672, L1475

BH6020

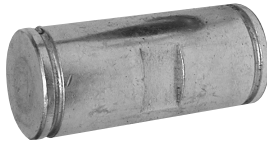

For "P" Style

O.D. 1-1/4"
Length 2-7/8"

Replaces: 15-526, 1259-Q-251, C66910, E-512S, L152

BH6037



For Eaton 12-1/4" Brake

O.D. 1-1/2"
Length 5-1/16"

Replaces: 15-540, B1705, C66649, L1209

BH3011

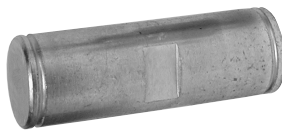

For Meritor 18" x 7" Brake. Late Model Mack

O.D. 1-1/4"
Length 3-3/4"

Replaces: 15-532, 1259-R-252, C65307, E-502, L113

BRAKE SHOE RETAINER SPRINGS

BH6013



For 16-1/2" Brake. Knurled

Length/Large Diam. 1-9/32"
O.D. 1-1/4"
Overall Length 2-7/32"

Replaces: 32-1425, 1779-R-18, C66911, E-523, L149

BH0008

For Dana 12-1/4" "FC-III" Brake.



O.D.: 13/16"
Overall Length 5-1/4"
Wire Diameter 0.128"

Replaces: 19-938, L3501

BH6010



For 16-1/2" Brake

Length/Large Diam. 1-9/32"
O.D. 1-3/8"
Overall Length 2-7/32"

Replaces: 32-1426, 1779-C-81, C65435, E-781, L294

BH0029



For Spicer 12-1/4" "U" Brake

O.D. 3/16"
Overall Length 5"
Wire Diameter 0.175"

Replaces: 34-1563, 208109, C67488, E-5305, L2367



BRAKE HARDWARE KIT COMPONENTS

BRAKE SHOE RETAINER SPRINGS/RETURN SPRINGS

BH0026

For Meritor "T", Eaton and Wagner 15" x 4" Brakes



BLACK

O.D.: 5/8"
Overall Length 3-7/8"
Wire Diameter 0.100"

Replaces: 19-922, 1003999, C66835 E-5122, L2825, R567501

BH0028

For Meritor 15" x 4" "Q" Front Brakes



BLUE

O.D.: 7/64"
Overall Length 5-9/32"
Wire Diameter 0.112"

Replaces: 19-903, 2258-E-1123, C66854, E-3873, L2932

BH0002

For multiapplications



ORANGE

O.D. 3/4"
Overall Length 5-1/2"
Wire Diameter 0.125"

Replaces: 19-860, 2258-Q-615, C66863, E-2767, L1417

BH0036

For Bendix 16-1/2" Brake



BLACK

O.D. 3/4"
Overall Length 5-13/16"
Wire Diameter 0.162"

Replaces: 19-905, L2986

BH0038

For Bendix 16-1/2" Truck/Tractor Brake



BLACK

O.D. 11/16"
Overall Length 5-1/4"
Wire Diameter 0.125"

Replaces: 19-907, L2994

BH0007

For Eaton 16-1/2" "ES-II" Brake



ORANGE

O.D. 13/16"
Overall Length 5-1/2"
Wire Diameter 0.128"

Replaces: 819725, C63005, E-10198, L3369

BH0004

For Eaton 16-1/2" S.A.P. Fab Steel Shoe



ORANGE

O.D. 1"
Overall Length 4-7/16"
Wire Diameter 0.142"

Replaces: 19-859, C65320, E-1418, L967, R567502

BH0032

For Eaton 18" x 7" S.A.P. Brake



GREEN

O.D. 1-1/4"
Overall Length 4-5/8"
Wire Diameter 0.160"

Replaces: 19-877, 1000092, C66606, E-2805, L1625

BRAKE SHOE RETURN SPRINGS

BH0027

For Eaton 12-1/4" Brake



BLACK

O.D. 1/2"
Overall Length 6"
Wire Diameter 0.098"

Replaces: 19-866, B2010, C66653, E-1400, L1035, R567003

BH0044

For 12-1/4" Brakes, Heavy Duty Version



BLUE

O.D. 3/4"
Overall Length 4-3/16"
Wire Diameter --

Replaces: 19-857, E-2101, R567011

BRAKE HARDWARE KIT COMPONENTS

BRAKE SHOE RETURN SPRINGS



BH0017

For Meritor 18" x 7" Brake



GREEN

O.D.	3/4"
Overall Length	6"
Wire Diameter	0.135"

Replaces: 19-865, 2258R590, C66612, E-3512, L2858

BH0011

For Standard Forge 12-1/4" Brake, Meritor 16-1/4" Brake



BLACK

O.D.	1"
Overall Length	6-1/4"
Wire Diameter	0.140"

Replaces: 2258-V-256, C66849, E-757, L385

BH0023

For Meritor "T" 15" x 4" Brake



BLACK

O.D.	13/16"
Overall Length	7-11/16"
Wire Diameter	0.146"

Replaces: 19-902, 2258-K-1181, C66853, E-3872, L2931

BH0014

For 12-1/4" Spicer/Standard Forge, Late Model Dexter "PQ" Brake after 5/96



BLUE

O.D.	1"
Overall Length	6-9/16"
Wire Diameter	0.135"

Replaces: 19-862, 208106, C67492, E-2398, L1279, R567005

BH0025

For Eaton 15" Front Brake



BLUE

O.D.	13/16"
Overall Length	7-1/8"
Wire Diameter	0.128"

Replaces: 19-923, 1006562, C66836, E-5123, L2829, R567009

BH0021

For Wagner 15" x 4" Front Brake

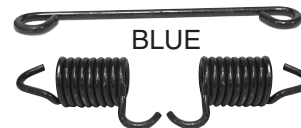

BLUE

O.D.	1"
Overall Length	10-1/8"
Wire Diameter	0.150"

Replaces: 19-891, C66880, E-2770, FC89177/8, L1693

BH0016

For Meritor "T" 15" Front Brake



GREEN

O.D.	7/8"
Overall Length	7-3/16"
Wire Diameter	0.125"

Replaces: 19-896, 2258-G-579, C66842, E-3437, L1734

BH0019

For Fruehauf 12-1/4" Brake



BLACK

O.D.	1-1/8"
Overall Length	6-3/4"
Wire Diameter	0.148"

Replaces: 19-863, ACD2287-1, C67446, E-1583, L1695, R567002

BH0039

For Eaton 12-1/4" "U" Brake



BLACK

O.D.	1"
Overall Length	5"
Wire Diameter	0.192"

Replaces: 19-864, 820276, C66652, L1034, R567004

BH0018

For Meritor 12-1/4" "Q" Brake



BLUE

O.D.	1-1/8"
Overall Length	6-7/8"
Wire Diameter	0.175"

Replaces: 19-882, 2258-B-704, 2258-T-124, C67465, E-3481A, L2351



BRAKE HARDWARE KIT COMPONENTS

BRAKE SHOE RETURN SPRINGS

BH0020

For Meritor "P" 16-1/2" Brake



GREEN

O.D.	1-1/8"
Overall Length	8"
Wire Diameter	0.162"

Replaces: 19-851, 2258-P-354, C65337, E-545A, L179

BH0013

For 16-1/2" Brake



ORANGE

O.D.	1-1/8"
Overall Length	8-3/8"
Wire Diameter	0.162"

Replaces: 19-856A, 2258-U-619, C66864, E-2768, E-3228, L1418

BH0041

For Meritor 15" "Q-PLUS" Front Brake



GRAY

O.D.	1-1/8"
Overall Length	8-3/8"
Wire Diameter	0.162"

Replaces: 19-856, 2258-L-1234, C63043, E-9063, L3069

BH0015

For Meritor 16-1/2" Brake



RED

O.D.	1-1/8"
Overall Length	8-3/8"
Wire Diameter	0.162"

Replaces: 2258-S-643, C63045, E-9069, L3183

BH0037

For Bexdix 16-1/2" Truck/Tractor Brake



BLUE

O.D.	1-1/8"
Overall Length	8-5/16"
Wire Diameter	0.162"

Replaces: 19-906, L2993

BH0024

For Meritor 18" x 7" Brake



BLACK

O.D.	1-1/8"
Overall Length	9"
Wire Diameter	0.162"

Replaces: 19-878, 2258-K-349, C66614, E-543, L115

BH0033

For Mack 16-1/2" "Q" Front Brake



BROWN

O.D.	1-1/8"
Overall Length	9"
Wire Diameter	0.164"

Replaces: 19-910, C66876, E-3824, L2843

BH0035

For Bendix 16-1/2" Truck/Tractor Front Brake



BLUE

O.D.	1-1/8"
Overall Length	9-3/4"
Wire Diameter	0.162"

Replaces: 19-904, L2985

BH0031

For Eaton 15" x 8-5/8" "ES" Reduced Envelope Drive Axle



WHITE

O.D.	1-1/8"
Overall Length	10-1/8"
Wire Diameter	0.203"

Replaces: 812992, C63051, E-9038, L3175

BH0006

For Eaton 16-1/2" "ES", "ES-II" Brake



GRAY

O.D.	1-1/8"
Overall Length	10-3/4"
Wire Diameter	0.192"

Replaces: 19-915, 818278, C63060, E-10197, L2962

BRAKE HARDWARE KIT COMPONENTS

BRAKE SHOE RETURN SPRINGS/ANCHOR PIN BUSHINGS



BH0003

For Eaton 16-1/2" Truck Brake



Replaces: 19-854, 78580, C65450, E-1428A/S, L-835, R567006

BH0030

For Eaton 15" x 6" "ES" Reduced Envelope Front Brake



Replaces: 817017, C63054, E-9037, L3173

BH0022

For Meritor 16-1/2" Front Brake



Replaces: 2258-Y-1273, C67320, E-9643, L3126

BH0012

For Eaton 16-1/2" Brake



Replaces: 19-874, 1000406, C67786, E-2475, L1603, R567001

BH0010

For 16-1/2" Brake



Replaces: 19-853, 2258-Z-416, C65449, E-1880B/S, L827

BH0001

For 16-1/2" Brake



Replaces: 19-853A, 2258-W-803, C66565, E-3490B/S, L-2370

BH0034

For Eaton S.A.P. 18" x 7" Brake



Replaces: 19-876, 1000091, C66607, E-2804, L1624

BRAKE SHOE ANCHOR PIN BUSHINGS

BH3008

For Cast or Bushed Brake Shoes



Overall length	11/16"
I.D.	1-1/4"
O.D.	1-3/8"

Replaces: 23-1026, C65306, E541, L112

BH3010

For Meritor 18" x 7" Brake. Stainless Steel.



Overall length	11/16"
I.D.	1-1/4"
O.D.	1-3/8"

Replaces: 1225-F-266, E-2218

BH3024

For Spicer 12-1/4" Brake

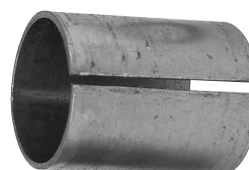

Overall length	1-7/16"
I.D.	1"
O.D.	1-1/8"

Replaces: 16-564, 405131, C67476, E-2389, L1373, R557001



BRAKE HARDWARE KIT COMPONENTS

BRAKE SHOE ANCHOR PIN BUSHINGS/WASHERS

BH3028



For Bendix 16-1/2" Brazilian Brake.
Stainless Steel.

Overall length 1-15/32"
I.D. 1-1/8"
O.D. 1-1/4"

Replaces: 16-566, L2995

BH3019



Offset Slot. **Use with BH6034.**

Overall length 1-15/32"
I.D. 1-1/4"
O.D. 1-3/8"

Replaces: 16-561, E-920S, L594

BH3002



Use with BH6025, BH6001 and BH6002 Anchor Pins

Overall length 1-15/32"
I.D. 1-1/4"
O.D. 1-3/8"

Replaces: 16-565, 1225-B-496, C63084, E-1893, L1498

BH3020



No Slot. Dimpled. **Use with BH6025, BH6001 and BH6002 Anchor Pins.**

Overall length 1-15/32"
I.D. 1-1/4"
O.D. 1-3/8"

Replaces: E-8938

BH3013



For Meritor 18" x 7" Cast Shoes. Use with BH3011, BH6020, Center Slot.

Overall length 1-15/32"
I.D. 1-1/4"
O.D. 1-3/8"

Replaces: 16-562, 1225-G-449, C65448, E-919, L595

BH3018



For Late Model Meritor & Fruehauf 16-1/2" "P" Brakes. Offset Slot, Stainless Steel. **Use with BH6034**

Overall length 1-15/32"
I.D. 1-1/4"
O.D. 1-3/8"

Replaces: 1225-A-443, AXA0068, C65366, E-920

BH3006



No Slot. , Stainless Steel.
Use with BH6025, BH6001 and BH0002 Anchor Pins.

Overall length 1-15/32"
I.D. 1-1/4"
O.D. 1-3/8"

Replaces: 16-563, 1225-B-496, E-1893, C63084, L1498

BH3009



For Std Forge - Spicer 12-1/4" Brake

Thickness 1/32"
I.D. 1"
O.D. 1-1/2"

Replaces: 35-1581, 403147, C67474, E-2391, L-1369, R547003

BH3022



For Meritor "Q", Eaton and Wagner 15" x 4" Brake

Thickness 5/32"
I.D. 13/16"
O.D. 1-1/4"

Replaces: 34-1562, 1229-V-1504, C66843, E-3874, L-2933

ANCHOR PIN WASHERS

CS3109



For Eaton 12-1/4" S.A.P. Brake.
Use with BH6037 Anchor Pin.

Thickness 1/16"
I.D. 1-17/32"
O.D. 2-1/4"

Replaces: 1229-R-122, 29-1307, C65339, E-380, L193

BRAKE HARDWARE KIT COMPONENTS

MISCELLANEOUS



BH3023



For Meritor 15" "T" Brake.
Use with BH6024.

Thickness 1/8"
I.D. 25/32"
O.D. 1-3/8"

Replaces: 34-1552, 1229-V-1556,
C66847, E-3427, L-1751

CS3102



Use with BH6025 Anchor Pin

Thickness 1-7/8"
I.D. 1-17/64"
O.D. 1/16"

Replaces: 1229-B-1848, 35-1580,
C65373, E-1113, L-889

ANCHOR PIN LOCK WASHERS

BH3029



For Eaton 12-1/4" Brake.
Use with BH6037.

I.D. 1"

Replaces: 34-1546, 821231,
C66654, HLW109

BH3037



For Spicer Std Forge 12-1/4" Brake

I.D. 7/8"
O.D. 31/32"
Thickness 3/32"

Replaces: 1229-M-221, E-1106,
L1106, M10HN154

LOCK NUTS

BH3027



For Meritor 15" x 3-1/2" & 4" "T" Brake.
Use with BH6027.

High 21/32"
Hex 1-1/16"
Thread 3/4" - 16

Replaces: 34-1551, E-4691A,
R004961A, W451

BH3031



For Spicer 12-1/4" Cast Shoes.
Use with BH6037 Anchor Pin.

High 7/8"
Hex 1-7/16"
Thread 1" - 14

Replaces: 34-1545, 821616,
C66651, E-937, R587001

RETURN SPRING PINS

BH3001

For multiapplications



O.D.: 1/4"
Overall Length 2-3/4"

Replaces: 20-881, 1218-G-85, C65351, E-747, L324

BH3015

For multiapplications



O.D.: 15/32"
Overall Length 2-1/8"

Replaces: 20-882, 207100, C67471, E-2399, L1535, R577001

BH3014

For Meritor 18" x 7" Brakes with Cast Shoes



O.D.: --
Overall Length --

Replaces: 34-1565, 1218-C-107, C66611, E-3513, L2859

ANCHOR PIN LOCK RINGS

BH3016

For 12-1/4" Brake.



Thickness 1/32"
I.D. 3/4"

Replaces: 34-1526, 1229-M-1105,
1229-T-3166, C65311,
E-527, L118, M10HR102

BH3017

For Spicer Standard Forge 12-1/4" Brake. Use with BH6023 Anchor Pin.



Thickness 3/64"
I.D. 15/16"

Replaces: 34-1527, 214107,
C67475, E-2392, L1370,
R547004

CS3140

For multiapplications



Thickness 1/16"
I.D. 1-1/8"

Replaces: 31-624, 34-1525,
1229-X-1116, C65358,
E-801, L397

CS3145

For multiapplications



Thickness 1/16"
I.D. 1-41/64"
O.D. 2-3/8"

Replaces: 29-1322, AXA0417-1,
C65377, E-1565, L895,
R627002

BH3025

Use with BH6026 Anchor Pin



Thickness 1/16"
I.D. 1-1/4"

Replaces: 34-1550, C66894,
E-2723, FC31926, L1670

ANCHOR PIN LINK

BH3034

For Meritor 15" Brake. Use with BH6027



High 15/16"
Hole Centers 2-5/16"
Length 4"

Replaces: 34-1561, 2205-P-1004, C69612, E-3871, L2934

BH3041

For Spicer 12-1/4" Trailer Brake

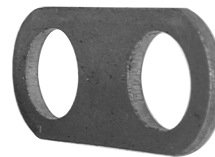

Hole Diameter 1"
Center to Center 1-15/16"
Overall Length 3-1/2"
Thickness 3/16"

Replaces: 34-1544, 999197, E-2401, L1278

BH3036

For Spicer-Std Forge 12-1/4" Trailer Brake

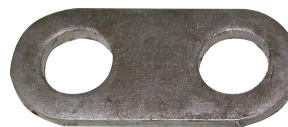

Hole Diameter 7/8"
Center to Center 1-15/16"
Overall Length 3-5/8"
Thickness 1/4"

Replaces: 34-1538, 999100, E-1289, L1284, M10HR101, R547005

BRAKE HARDWARE KIT COMPONENTS

MISCELLANEOUS



STAINLESS STEEL BRAKE SHOE BUSHING

BH3039



For Spicer 12-1/4" Brake

Overall Length 1-3/4"
I.D. 1"
O.D. 1-1/16"

Replaces: 23-1027, E-1808, L425, R547007

ROLLER PIN SET SCREW

BH3040



For 12-1/4" Cast Shoes. Cut Point, Grade 5.

Length 3/8"
Thread 1/4" -20
Thread Length 3/8"

Replaces: 34-1540, E-773, L145, S843

WASHER KIT

BH3026



For Wagner 15" Front Brake

Includes 4 sets of washers

Replaces: 19-892A, E-2724, E-2725, E-2726, L1671, L1673, L1674

HOLD DOWN ASSEMBLY

BH3021



For Wagner 15" Front Brake

Includes 4 Spring Retainers (3/4" O.D. x 1-1/2" LG), 4 Cups and 4 Pins

Replaces: 19-921, CQ66759, E-4800, K259 (2), KIT 9425

CLIP

BH3032



For 15" Brake.

Replaces: 19-920, 2257-T-1060, C65562, K284

LOCK SCREW

BH3012

For Meritor 18" x 7" Brake.



Thread Length 3/8" -16
3/4"

Replaces: 34-1539, C65331, E-579A, L168, S265D

SEAL

BH3007

For Meritor 18" x 7" Brake. Neoprene Seal.



O.D. 1-3/4"
I.D. 1-1/4"
Thickness 9/64"

Replaces: 35-1582, A-1205-S-1943, C65302, E-1269, L105

LOCK PIN

BH3030

Use with BH6034 Anchor Pin



O.D. 3/16"
Length 1-1/4"

Replaces: 34-1533, 1199-E-1695, C65345, L239