

hpaulin[®] METRIC FASTENERS

CLASS AND STRENGTH

METRIC FASTENERS designates strength capabilities as property class or class rather than grades as used in Imperial fasteners. Classes are numeric and are stamped on most bolts and nuts to identify the fastener's class. These fasteners are made to meet certain strength requirements. Always replace a fastener with same or higher grade (don't replace a Class 10.9 with a Class 8.8). If strength is important, verify the class marking is present.

- Tensile strength is the amount of force (pull) the bolt can withstand before not returning to its original length after the pressure is released. The harder the bolt, the greater tensile strength
- Yield strength is the amount of force (pull) it takes to make the bolt break

Common Metric Classes	Strength
Class 4	Similar to Grade 2
Class 8.8 / Class 8	Similar to Grade 5
Class 10.9 / Class 10	Similar to Grade 8
Class 12.9 / Class 12	Highest Class for strength, exceeds Grade 8

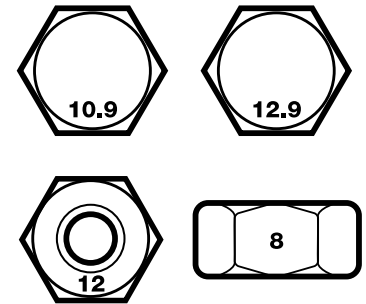

STAINLESS STEEL

18.8 STAINLESS STEEL is resistant to corrosion, has a long-service life and requires no maintenance. Using stainless steel offers the best-in-class corrosion protection compared to bare or zinc finishes. 18.8 stainless steel is ideal for fresh water and exterior weather exposure applications.

PACKAGING TYPES AVAILABLE

Clamshell



Handy Pak



Black Box



Bulk Carton (1/4 Keg)



608
Series

PAULIN[®] METRIC HEX HEAD CAP SCREWS

PART CLASS #
806BU | DIN 933 = ISO 4017 Fully Threaded
806AI | DIN 931 = ISO 4014 Partially Threaded

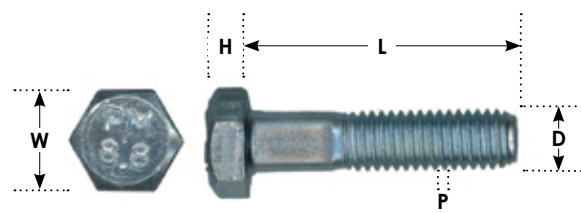

METRIC HEX HEAD CAP SCREWS are similar to imperial fasteners in types, head styles, drives and applications and can often be confused with their imperial counterparts. Always check carefully the fastener being replaced to determine whether it is an imperial or metric fastener.

A/F = Across Flats (W) W = Width H = Height L = Length D = Diameter P = Pitch

ORDER BY ITEM (PACKAGE) NUMBER

ISO Coarse Thread

Product not available in this pack size

ZINC PLATED

Diameter-Pitch: M4-.70							Across Flats: 7 Height: 2.8			
Length	DIN	Approx. Weight (lb) /100 pcs	Clamshell #	Qty	Handy Pak #	Qty	Black Box #	Qty	Bulk Carton #	Qty
12 mm	933	0.39	—	—	—	—	608-136	100	—	—
16 mm	933	0.47	—	—	—	—	608-139	100	B608-139	8000
20 mm	933	0.53	—	—	—	—	608-141	100	—	—
25 mm	933	0.67	—	—	024-004	11	608-143	100	—	—

Diameter-Pitch: M5-.80							Across Flats: 8 Height: 3.5			
Length	DIN	Approx. Weight (lb) /100 pcs	Clamshell #	Qty	Handy Pak #	Qty	Black Box #	Qty	Bulk Carton #	Qty
12 mm	933	0.63	—	—	024-012	25	608-198	100	B608-198	6300
16 mm	933	0.73	—	—	024-013	19	608-201	100	B608-201	5400
20 mm	933	0.81	—	—	024-014	17	608-203	100	B608-203	4700
25 mm	933	0.99	—	—	024-015	16	608-205	100	B608-205	3900

Diameter-Pitch: M6-1.00							Across Flats: 10 Height: 4.0			
Length	DIN	Approx. Weight (lb) /100 pcs	Clamshell #	Qty	Handy Pak #	Qty	Black Box #	Qty	Bulk Carton #	Qty
12 mm	933	1.01	009-221	14	024-023	21	608-267	100	B608-267	3700
16 mm	933	1.19	009-222	12	024-024	18	608-270	100	B608-270	3000
20 mm	933	1.32	009-223	10	024-025	17	608-272	100	B608-272	3000
25 mm	933	1.53	009-224	8	024-026	15	608-274	100	B608-274	2500
30 mm	933	1.80	009-225	7	024-027	13	608-276	100	B608-276	2200
35 mm	931	2.03	009-226	4	024-028	10	608-277	100	B608-277	1900
35 mm	933	2.03	—	—	—	—	608-277TFL	100	B608-277TFL	1900
40 mm	931	2.26	009-227	4	024-029	10	608-278	100	B608-278	1750
40 mm	933	2.26	—	—	—	—	608-278TFL	100	B608-278TFL	1750
45 mm	931	2.50	—	—	024-030	9	608-279	100	B608-279	1600
50 mm	931	2.76	—	—	024-031	9	608-280	100	B608-280	1400
55 mm	931	2.90	—	—	—	—	608-281	100	B608-281	1000
60 mm	931	3.30	—	—	—	—	608-283	100	B608-283	1000
65 mm	931	3.30	—	—	—	—	608-284	100	B608-284	750
70 mm	931	3.74	—	—	—	—	608-285	100	B608-285	900
75 mm	931	3.90	—	—	—	—	608-286	100	B608-286	750
80 mm	931	4.24	—	—	—	—	608-287	100	B608-287	800
90 mm	931	4.50	—	—	—	—	608-289	100	B608-289	550
100 mm	931	5.00	—	—	—	—	608-291	100	B608-291	450

608
Series

paulin METRIC HEX HEAD CAP SCREWS

PART CLASS #

806BU | DIN 933 = ISO 4017 Fully Threaded
806AI | DIN 931 = ISO 4014 Partially Threaded

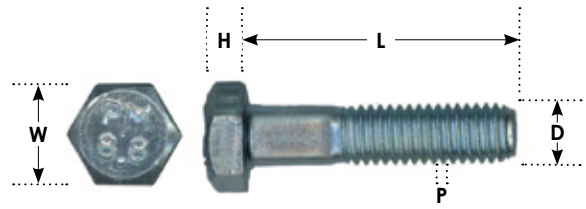

A/F = Across Flats (W) W = Width H = Height L = Length D = Diameter P = Pitch

ORDER BY ITEM (PACKAGE) NUMBER

ISO Coarse Thread

Product not available in this pack size

ZINC PLATED										
Diameter-Pitch: M8-1.25							Across Flats: 13 Height: 5.5			
Length	DIN	Approx. Weight (lb) /100 pcs	Clamshell #	Qty	Handy Pak #	Qty	Black Box #	Qty	Bulk Carton #	Qty
12 mm	933	2.00	—	—	024-045	9	608-311	100	B608-311	2000
16 mm	933	2.35	009-228	10	024-046	9	608-314	100	B608-314	1700
20 mm	933	2.66	009-229	9	024-047	9	608-316	100	B608-316	1500
25 mm	933	2.96	009-230	8	024-048	9	608-318	100	B608-318	1350
30 mm	933	3.34	009-231	7	024-049	8	608-320	100	B608-320	1150
35 mm	931	3.87	009-232	4	024-050	7	608-321	100	B608-321	1000
40 mm	931	4.30	009-233	5	024-051	6	608-322	100	B608-322	925
40 mm	933	4.30	—	—	—	—	608-322TFL	100	B608-322TFL	925
45 mm	931	4.76	009-234	5	024-052	5	608-323	100	B608-323	850
50 mm	931	5.10	009-235	4	024-053	5	608-324	100	B608-324	750
55 mm	931	5.50	—	—	—	—	608-325	100	B608-325	700
60 mm	931	6.10	—	—	024-055	4	608-326	100	B608-326	650
65 mm	931	6.20	—	—	—	—	608-327	100	B608-327	600
70 mm	931	6.50	—	—	024-057	3	608-328	100	B608-328	550
75 mm	933	6.94	—	—	—	—	608-329TFL	100	B608-329TFL	550
80 mm	931	7.72	—	—	—	—	608-330	100	B608-330	500
90 mm	931	8.40	—	—	—	—	608-331	100	B608-331	450
100 mm	931	9.30	—	—	—	—	608-332	100	B608-332	400
110 mm	931	10.10	—	—	—	—	608-333	100	B608-333	350
120 mm	931	10.70	—	—	—	—	608-334	100	B608-334	350
130 mm	931	11.70	—	—	—	—	608-335	100	B608-335	300
140 mm	931	13.20	—	—	—	—	608-338	100	B608-338	250
150 mm	931	13.30	—	—	—	—	608-339	100	B608-339	250
160 mm	931	14.30	—	—	—	—	608-340	100	B608-340	250
180 mm	931	15.90	—	—	—	—	608-342	100	B608-342	225
200 mm	931	17.70	—	—	—	—	608-344	100	B608-344	225

608
Series

paulin[®] METRIC HEX HEAD CAP SCREWS

PART CLASS #

806BU | DIN 933 = ISO 4017 Fully Threaded
806AI | DIN 931 = ISO 4014 Partially Threaded

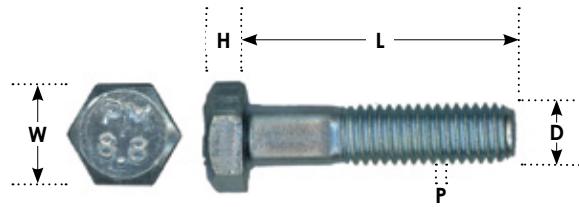

A/F = Across Flats (W) W = Width H = Height L = Length D = Diameter P = Pitch

ORDER BY ITEM (PACKAGE) NUMBER

ISO Coarse Thread

Product not available in this pack size

ZINC PLATED										
Diameter-Pitch: M10-1.50							Across Flats: 17 Height: 7.0			
Length	DIN	Approx. Weight (lb) /100 pcs	Clamshell #	Qty	Handy Pak #	Qty	Black Box #	Qty	Bulk Carton #	Qty
16 mm	933	4.23	—	—	—	—	608-364	100	B608-364	950
20 mm	933	4.81	009-236	5	024-060	5	608-366	100	B608-366	850
25 mm	933	5.44	009-237	4	024-061	4	608-368	100	B608-368	750
30 mm	933	5.96	009-238	4	024-062	4	608-370	100	B608-370	700
35 mm	933	6.52	009-239	3	024-063	4	608-371	100	B608-371	600
40 mm	931	7.31	009-240	3	024-064	4	608-372	100	B608-372	550
40 mm	933	7.31	—	—	—	—	608-372TFL	100	B608-372TFL	550
45 mm	931	7.91	—	—	—	—	608-373	100	B608-373	500
50 mm	931	8.63	009-241	2	024-066	3	608-374	100	B608-374	450
50 mm	933	8.63	—	—	—	—	608-374TFL	100	B608-374TFL	450
55 mm	931	9.20	—	—	—	—	608-375	100	B608-375	450
60 mm	931	10.01	009-242	2	024-068	3	608-376	100	B608-376	400
65 mm	931	10.50	—	—	—	—	608-377	100	B608-377	400
70 mm	931	11.22	009-243	2	024-070	3	608-378	100	B608-378	350
75 mm	931	11.86	—	—	—	—	608-379	100	B608-379	300
80 mm	931	12.54	—	—	—	—	608-380	100	B608-380	300
90 mm	931	13.80	—	—	—	—	608-381	100	B608-381	250
100 mm	931	15.70	—	—	—	—	608-382	100	B608-382	250
110 mm	931	16.80	—	—	—	—	608-383	100	B608-383	200
120 mm	931	18.00	—	—	—	—	608-384	100	B608-384	200
130 mm	931	19.20	—	—	—	—	608-385	100	B608-385	175
140 mm	931	20.80	—	—	—	—	608-386	100	B608-386	175
150 mm	931	22.00	—	—	—	—	608-387	100	B608-387	150
160 mm	931	23.20	—	—	—	—	608-388	100	B608-388	175
180 mm	931	27.00	—	—	—	—	608-390	100	B608-390	150
200 mm	931	29.00	—	—	—	—	608-392	100	B608-392	150

608
Series

paulin METRIC HEX HEAD CAP SCREWS

PART CLASS #

806BU | DIN 933 = ISO 4017 Fully Threaded
806AI | DIN 931 = ISO 4014 Partially Threaded

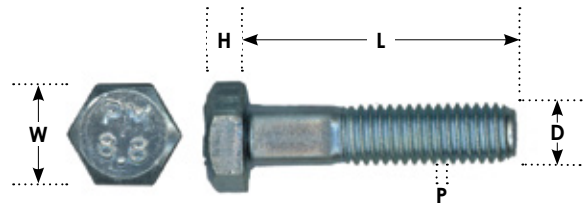

A/F = Across Flats (W) W = Width H = Height L = Length D = Diameter P = Pitch

ORDER BY ITEM (PACKAGE) NUMBER
ISO Coarse Thread

Product not available in this pack size

ZINC PLATED										
Diameter-Pitch: M12-1.75							Across Flats: 19 Height: 8.0			
Length	DIN	Approx. Weight (lb) /100 pcs	Clamshell #	Qty	Handy Pak #	Qty	Black Box #	Qty	Bulk Carton #	Qty
20 mm	933	7.10	—	—	—	—	608-410	50	B608-410	600
25 mm	933	7.81	009-244	2	—	—	608-412	50	B608-412	500
30 mm	933	8.57	—	—	024-075	3	608-414	50	B608-414	450
35 mm	933	9.40	009-245	2	—	—	608-415	50	B608-415	400
40 mm	933	10.28	009-246	2	024-077	3	608-416	50	B608-416	370
45 mm	931	11.43	—	—	—	—	608-417	50	B608-417	325
45 mm	933	11.43	—	—	—	—	608-417TFL	50	B608-417TFL	325
50 mm	931	12.53	009-247	2	024-079	3	608-418	50	B608-418	300
50 mm	933	12.53	—	—	—	—	608-418TFL	50	B608-418TFL	300
55 mm	931	13.20	—	—	—	—	608-419	50	B608-419	275
60 mm	931	14.34	009-248	2	024-081	2	608-420	50	B608-420	260
65 mm	931	14.90	—	—	—	—	—	—	B608-421	250
70 mm	931	16.17	009-249	2	024-083	2	608-422	50	B608-422	225
75 mm	931	17.15	—	—	—	—	608-423	50	B608-423	225
80 mm	931	18.42	—	—	—	—	608-424	50	B608-424	200
90 mm	931	20.51	—	—	—	—	608-425	50	B608-425	175
100 mm	931	22.00	—	—	—	—	608-426	50	B608-426	175
110 mm	931	23.40	—	—	—	—	608-427	50	B608-427	150
120 mm	931	25.85	—	—	—	—	608-428	50	B608-428	150
130 mm	931	27.64	—	—	—	—	608-429	50	B608-429	125
140 mm	931	29.47	—	—	—	—	608-430	50	B608-430	125
150 mm	931	62.80	—	—	—	—	608-431	25	B608-431	125
160 mm	931	33.60	—	—	—	—	608-432	25	B608-432	120
170 mm	931	35.32	—	—	—	—	608-433	25	B608-433	110
180 mm	931	37.58	—	—	—	—	608-434	25	B608-434	100
200 mm	931	40.82	—	—	—	—	608-435	25	B608-435	90

608
Series

paulin® METRIC HEX HEAD CAP SCREWS

PART CLASS #
806BU | DIN 933 = ISO 4017 Fully Threaded
806AI | DIN 931 = ISO 4014 Partially Threaded

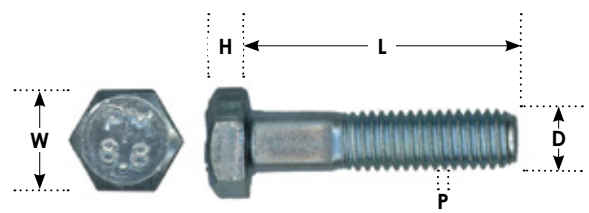

A/F = Across Flats (W) W = Width H = Height L = Length D = Diameter P = Pitch

ORDER BY ITEM (PACKAGE) NUMBER

ISO Coarse Thread

Product not available in this pack size

ZINC PLATED

Diameter-Pitch: M14-2.00							Across Flats: 21 Height: 8.8			
Length	DIN	Approx. Weight (lb) /100 pcs	Clamshell #	Qty	Handy Pak #	Qty	Black Box #	Qty	Bulk Carton #	Qty
25 mm	933	11.54	—	—	—	—	608-436	100	B608-436	350
30 mm	933	12.74	—	—	—	—	608-438	100	B608-438	325
35 mm	933	13.98	—	—	—	—	608-439	100	B608-439	275
40 mm	933	15.20	—	—	—	—	608-440	100	B608-440	275
45 mm	933	16.30	—	—	—	—	608-441	100	B608-441	250
50 mm	931	18.04	—	—	—	—	608-442	100	B608-442	230
50 mm	933	18.04	—	—	—	—	608-442TFL	100	B608-442TFL	230
55 mm	931	—	—	—	—	—	608-443	100	B608-443	225
55 mm	933	—	—	—	—	—	608-443TFL	100	B608-443TFL	225
60 mm	931	21.42	—	—	—	—	608-444	100	B608-444	200
65 mm	931	—	—	—	—	—	608-445	100	—	—
70 mm	931	23.22	—	—	—	—	608-446	100	B608-446	175
75 mm	931	24.00	—	—	—	—	608-447	100	B608-447	200
80 mm	931	25.66	—	—	—	—	608-448	100	B608-448	150
90 mm	931	28.32	—	—	—	—	608-449	100	B608-449	125
100 mm	931	31.04	—	—	—	—	608-450	100	B608-450	125
110 mm	931	16.80	—	—	—	—	608-383	100	—	—
110 mm	931	33.42	—	—	—	—	608-451	100	B608-451	110
120 mm	931	35.84	—	—	—	—	608-384	100	—	—
120 mm	931	35.84	—	—	—	—	608-452	100	B608-452	100

608
Series

paulin[®] METRIC HEX HEAD CAP SCREWS

PART CLASS #

806BU | DIN 933 = ISO 4017 Fully Threaded
806AI | DIN 931 = ISO 4014 Partially Threaded

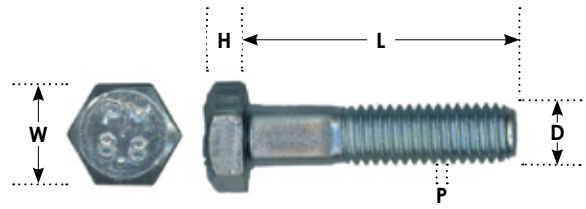

A/F = Across Flats (W) W = Width H = Height L = Length D = Diameter P = Pitch

ORDER BY ITEM (PACKAGE) NUMBER

ISO Coarse Thread

Product not available in this pack size

ZINC PLATED										
Diameter-Pitch: M16-2.00							Across Flats: 24 Height: 10			
Length	DIN	Approx. Weight (lb) /100 pcs	Clamshell #	Qty	Handy Pak #	Qty	Black Box #	Qty	Bulk Carton #	Qty
25 mm	933	15.44	—	—	—	—	608-462	25	B608-462	400
30 mm	933	17.06	—	—	—	—	608-464	25	B608-464	225
35 mm	933	18.36	—	—	—	—	608-465	25	B608-465	200
40 mm	933	20.18	—	—	—	—	608-466	25	B608-466	200
45 mm	933	21.74	—	—	—	—	608-467	25	B608-467	175
50 mm	931	23.46	—	—	—	—	608-468	25	B608-468	165
50 mm	933	23.46	—	—	—	—	608-468TFL	25	B608-468TFL	165
55 mm	931	25.20	—	—	—	—	608-469	25	B608-469	150
60 mm	931	26.68	—	—	—	—	608-470	25	B608-470	150
65 mm	931	28.40	—	—	—	—	608-471	25	B608-471	125
70 mm	931	30.08	—	—	—	—	608-472	25	B608-472	125
75 mm	931	31.80	—	—	—	—	608-473	25	B608-473	125
80 mm	931	33.28	—	—	—	—	608-474	25	B608-474	110
90 mm	931	37.42	—	—	—	—	608-475	25	B608-475	100
100 mm	931	40.00	—	—	—	—	608-476	25	B608-476	95
110 mm	931	44.12	—	—	—	—	608-477	25	B608-477	90
120 mm	931	47.36	—	—	—	—	608-478	25	B608-478	80
130 mm	931	50.42	—	—	—	—	608-479	25	B608-479	75
140 mm	931	52.88	—	—	—	—	608-480	25	B608-480	70
150 mm	931	56.36	—	—	—	—	608-481	25	B608-481	70
160 mm	931	60.96	—	—	—	—	608-482	25	B608-482	65
180 mm	931	67.60	—	—	—	—	608-484	25	B608-484	55
200 mm	931	74.40	—	—	—	—	608-486	25	B608-486	50

608
Series

paulin METRIC HEX HEAD CAP SCREWS

PART CLASS #
806BU | DIN 933 = ISO 4017 Fully Threaded
806AI | DIN 931 = ISO 4014 Partially Threaded

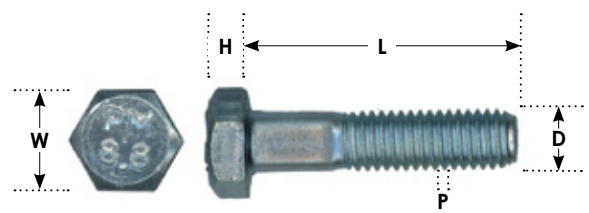

A/F = Across Flats (W) W = Width H = Height L = Length D = Diameter P = Pitch

ORDER BY ITEM (PACKAGE) NUMBER

ISO Coarse Thread

Product not available in this pack size

ZINC PLATED										
Diameter-Pitch: M18-2.50							Across Flats: 27 Height: 11.5			
Length	DIN	Approx. Weight (lb) /100 pcs	Clamshell #	Qty	Handy Pak #	Qty	Black Box #	Qty	Bulk Carton #	Qty
40 mm	933	26.66	—	—	—	—	608-500	25	B608-500	200
50 mm	933	30.48	—	—	—	—	608-502	25	B608-502	180
60 mm	931	34.68	—	—	—	—	608-504	25	B608-504	145
65 mm	931	36.48	—	—	—	—	608-505	25	—	—
70 mm	931	39.24	—	—	—	—	608-506	25	B608-506	135
75 mm	931	40.11	—	—	—	—	608-507	25	B608-507	120
80 mm	931	43.56	—	—	—	—	608-508	25	B608-508	100
90 mm	931	48.00	—	—	—	—	608-509	25	B608-509	100
100 mm	931	52.06	—	—	—	—	608-510	25	B608-510	100
110 mm	931	57.87	—	—	—	—	608-511	25	B608-511	100
120 mm	931	60.80	—	—	—	—	608-512	25	B608-512	100
130 mm	931	64.32	—	—	—	—	608-513	25	B608-513	80
140 mm	931	69.10	—	—	—	—	608-514	25	B608-514	80
150 mm	931	73.18	—	—	—	—	608-515	25	B608-515	50
160 mm	931	—	—	—	—	—	608-516	25	B608-516	65
180 mm	931	8.68	—	—	—	—	608-491	25	B608-491	55
200 mm	931	9.52	—	—	—	—	608-493	25	B608-493	50

608
Series

paulin METRIC HEX HEAD CAP SCREWS

PART CLASS #

806BU | DIN 933 = ISO 4017 Fully Threaded
806AI | DIN 931 = ISO 4014 Partially Threaded

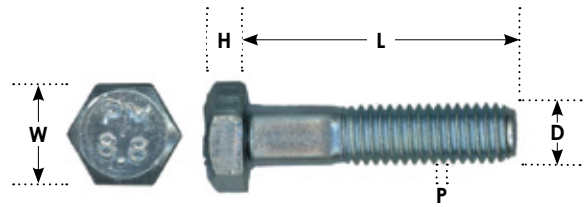

A/F = Across Flats (W) W = Width H = Height L = Length D = Diameter P = Pitch

ORDER BY ITEM (PACKAGE) NUMBER

ISO Coarse Thread

Product not available in this pack size

ZINC PLATED										
Diameter-Pitch: M20-2.50							Across Flats: 30 Height: 12.5			
Length	DIN	Approx. Weight (lb) /100 pcs	Clamshell #	Qty	Handy Pak #	Qty	Black Box #	Qty	Bulk Carton #	Qty
30 mm	933	32.43	—	—	—	—	—	—	B608-518	130
40 mm	933	34.92	—	—	—	—	608-520	25	B608-520	110
45 mm	933	36.60	—	—	—	—	608-521	25	B608-521	100
50 mm	933	39.14	—	—	—	—	608-522	25	B608-522	100
60 mm	933	43.80	—	—	—	—	608-524	25	B608-524	90
70 mm	931	49.32	—	—	—	—	608-526	25	B608-526	80
75 mm	931	52.08	—	—	—	—	608-527	25	B608-527	75
80 mm	931	55.10	—	—	—	—	608-528	25	B608-528	70
90 mm	931	60.08	—	—	—	—	608-529	25	B608-529	65
100 mm	931	65.66	—	—	—	—	608-530	25	B608-530	60
110 mm	931	72.60	—	—	—	—	—	—	B608-531	55
120 mm	931	76.16	—	—	—	—	608-532	25	B608-532	50
130 mm	931	82.30	—	—	—	—	608-533	10	B608-533	45
140 mm	931	88.50	—	—	—	—	608-534	10	B608-534	45
150 mm	931	92.40	—	—	—	—	608-535	10	B608-535	40
160 mm	931	97.50	—	—	—	—	608-536	10	B608-536	35
170 mm	931	102.12	—	—	—	—	608-537	10	B608-537	35
180 mm	931	108.20	—	—	—	—	608-538	10	B608-538	35
200 mm	931	119.00	—	—	—	—	608-540	10	B608-540	30

608
Series

paulin METRIC HEX HEAD CAP SCREWS

PART CLASS #
806BU | DIN 933 = ISO 4017 Fully Threaded
806AI | DIN 931 = ISO 4014 Partially Threaded

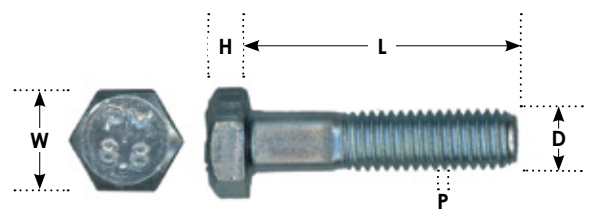

A/F = Across Flats (W) W = Width H = Height L = Length D = Diameter P = Pitch

ORDER BY ITEM (PACKAGE) NUMBER

ISO Coarse Thread

Product not available in this pack size

ZINC PLATED										
Diameter-Pitch: M24-3.00							Across Flats: 36 Height: 15			
Length	DIN	Approx. Weight (lb) /100 pcs	Clamshell #	Qty	Handy Pak #	Qty	Black Box #	Qty	Bulk Carton #	Qty
40 mm	933	54.46	—	—	—	—	608-551	25	B608-551	70
50 mm	933	60.28	—	—	—	—	608-552	25	B608-552	65
60 mm	933	67.04	—	—	—	—	608-554	25	B608-554	60
70 mm	931	74.48	—	—	—	—	608-556	25	B608-556	50
80 mm	931	87.85	—	—	—	—	608-558	25	B608-558	45
90 mm	931	90.30	—	—	—	—	608-559	10	B608-559	40
100 mm	931	98.95	—	—	—	—	608-560	10	B608-560	40
110 mm	931	106.00	—	—	—	—	608-561	10	B608-561	35
120 mm	931	116.89	—	—	—	—	608-562	10	B608-562	35
130 mm	931	124.15	—	—	—	—	608-563	10	B608-563	30
140 mm	931	129.20	—	—	—	—	608-564	10	B608-564	30
150 mm	931	137.30	—	—	—	—	608-565	10	B608-565	25
160 mm	931	145.68	—	—	—	—	608-566	10	B608-566	25
170 mm	931	152.94	—	—	—	—	608-567	10	—	—
180 mm	931	160.20	—	—	—	—	608-568	10	B608-568	20
200 mm	931	175.00	—	—	—	—	608-570	10	B608-570	18

609
Series

paulin[®] METRIC HEX HEAD CAP SCREWS

PART CLASS #

806BU | DIN 933 = ISO 4017 Fully Threaded
806AI | DIN 931 = ISO 4014 Partially Threaded

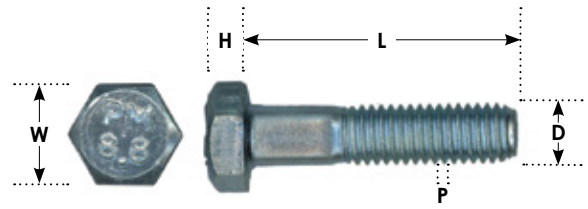

A/F = Across Flats (W) W = Width H = Height L = Length D = Diameter P = Pitch

ORDER BY ITEM (PACKAGE) NUMBER
ISO Fine Thread

Product not available in this pack size

ZINC PLATED										
Diameter-Pitch: M8-1.00							Across Flats: 13 Height: 5.3			
Length	DIN	Approx. Weight (lb) /100 pcs	Clamshell #	Qty	Handy Pak #	Qty	Black Box #	Qty	Bulk Carton #	Qty
16 mm	931	2.56	009-228	10	—	—	609-314	50	B609-314	1800
20 mm	931	2.73	009-229	9	024-120	7	609-316	50	B609-316	1500
25 mm	931	3.08	009-230	8	—	—	609-318	50	B609-318	1400
30 mm	931	3.42	009-231	7	024-122	7	609-320	50	B609-320	1150
35 mm	933	3.95	009-232	6	—	—	609-321TFL	50	B609-321TFL	1000
40 mm	931	4.36	009-233	5	024-124	6	609-322	50	B609-322	925
40 mm	933	4.36	—	—	—	—	609-322TFL	50	B609-322TFL	925
45 mm	933	4.68	009-234	5	—	—	609-323TFL	50	B609-323TFL	850
50 mm	931	5.32	009-235	4	024-126	5	609-324	50	B609-324	750
50 mm	933	5.32	—	—	—	—	609-324TFL	50	B609-324TFL	750

Diameter-Pitch: M10-1.25										
Across Flats: 16 Height: 6.4										
Length	DIN	Approx. Weight (lb) /100 pcs	Clamshell #	Qty	Handy Pak #	Qty	Black Box #	Qty	Bulk Carton #	Qty
16 mm	931	5.32	—	—	—	—	609-364	50	B609-364	950
20 mm	931	4.57	—	—	024-130	4	609-366	25	B609-366	850
25 mm	931	4.90	—	—	024-131	3	609-368	25	B609-368	750
30 mm	931	5.48	009-156	1	024-132	3	609-370	25	B609-370	700
35 mm	931	6.04	—	—	024-133	4	609-371	25	—	—
40 mm	931	6.68	009-157	1	024-134	3	609-372	25	B609-372	550
40 mm	933	6.68	—	—	—	—	609-372TFL	25	B609-372TFL	550
45 mm	931	8.06	—	—	—	—	609-373	25	B609-373	500
50 mm	931	8.66	009-158	1	024-136	3	609-374	25	B609-374	450
60 mm	931	10.02	—	—	024-138	2	609-376	25	B609-376	400
70 mm	931	11.74	—	—	—	—	609-378	25	B609-378	350
80 mm	931	13.06	—	—	—	—	609-380	25	B609-380	300
90 mm	931	13.62	—	—	—	—	609-382	25	B609-382	250
100 mm	931	15.74	—	—	—	—	609-384	25	B609-384	250

609
Series

paulin[®] METRIC HEX HEAD CAP SCREWS

PART CLASS #
806BU | DIN 933 = ISO 4017 Fully Threaded
806AI | DIN 931 = ISO 4014 Partially Threaded

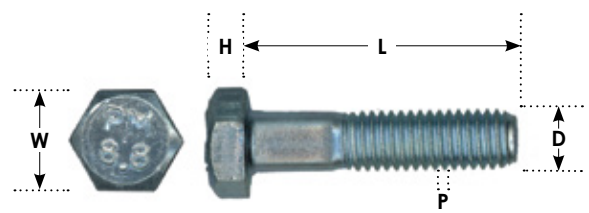

A/F = Across Flats (**W**) **W** = Width **H** = Height **L** = Length **D** = Diameter **P** = Pitch

ORDER BY ITEM (PACKAGE) NUMBER

ISO Fine Thread

Product not available in this pack size

ZINC PLATED										
Diameter-Pitch: M12-1.50							Across Flats: 18 Height: 7.5			
Length	DIN	Approx. Weight (lb) /100 pcs	Clamshell #	Qty	Handy Pak #	Qty	Black Box #	Qty	Bulk Carton #	Qty
20 mm	931	7.18	—	—	—	—	609-410	25	B609-410	600
25 mm	931	8.00	—	—	—	—	609-412	25	B609-412	650
30 mm	931	8.72	009-159	1	024-144	3	609-414	25	B609-414	450
35 mm	931	9.68	—	—	—	—	609-415	25	B609-415	500
40 mm	931	10.38	009-160	1	024-146	2	609-416	25	B609-416	370
45 mm	931	10.92	—	—	—	—	609-417	25	B609-417	325
50 mm	931	11.98	009-161	1	024-148	2	609-418	25	B609-418	300
55 mm	931	13.84	—	—	—	—	609-419	25	B609-419	275
60 mm	931	14.68	—	—	—	—	609-420	25	B609-420	260
65 mm	931	15.20	—	—	—	—	609-421	25	B609-421	250
70 mm	931	17.88	—	—	—	—	609-422	25	B609-422	225
80 mm	931	18.40	—	—	—	—	609-424	25	B609-424	200
90 mm	931	20.38	—	—	—	—	609-425	25	B609-425	250
100 mm	931	22.38	—	—	—	—	609-426	25	B609-426	175

Diameter-Pitch: M14-1.50							Across Flats: 21 Height: 8.8			
Length	DIN	Approx. Weight (lb) /100 pcs	Clamshell #	Qty	Handy Pak #	Qty	Black Box #	Qty	Bulk Carton #	Qty
25 mm	931	11.64	—	—	—	—	609-436	25	B609-436	350
30 mm	931	12.68	—	—	—	—	609-438	25	B609-438	325
35 mm	931	14.16	—	—	—	—	609-439	25	B609-439	300
40 mm	931	15.20	—	—	—	—	609-440	25	B609-440	275
45 mm	931	16.40	—	—	—	—	609-441	25	B609-441	250
50 mm	931	18.04	—	—	—	—	609-442	25	B609-442	230
55 mm	933	18.96	—	—	—	—	609-443TFL	25	B609-443TFL	250
60 mm	931	21.62	—	—	—	—	609-444	25	B609-444	200
70 mm	931	23.20	—	—	—	—	609-446	25	B609-446	175
80 mm	931	26.10	—	—	—	—	609-448	25	B609-448	150

609
Series

paulin[®] METRIC HEX HEAD CAP SCREWS

PART CLASS #

806BU | DIN 933 = ISO 4017 Fully Threaded
806AI | DIN 931 = ISO 4014 Partially Threaded

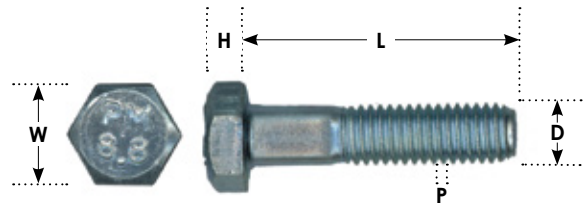

A/F = Across Flats (**W**) **W** = Width **H** = Height **L** = Length **D** = Diameter **P** = Pitch

ORDER BY ITEM (PACKAGE) NUMBER

ISO Fine Thread

Product not available in this pack size

ZINC PLATED

Diameter-Pitch: M16-1.50							Across Flats: 24 Height: 10				
Length	DIN	Approx. Weight (lb) /100 pcs	Clamshell #	Qty	Handy Pak #	Qty	Black Box #	Qty	Bulk Carton #	Qty	
30 mm	931	17.18	—	—	—	—	609-464	25	B609-464	225	
40 mm	931	20.54	—	—	—	—	609-466	25	B609-466	200	
50 mm	931	23.74	—	—	—	—	609-468	25	B609-468	165	
60 mm	931	27.52	—	—	—	—	609-470	25	B609-470	150	
70 mm	931	30.84	—	—	—	—	609-472	25	—	—	
80 mm	931	34.10	—	—	—	—	609-474	25	B609-474	110	
90 mm	931	37.58	—	—	—	—	609-475	25	B609-475	100	
100 mm	931	39.14	—	—	—	—	609-476	25	B609-476	95	
110 mm	931	42.50	—	—	—	—	609-477	25	B609-477	90	

Diameter-Pitch: M18-1.50							Across Flats: 27 Height: 11.5				
Length	DIN	Approx. Weight (lb) /100 pcs	Clamshell #	Qty	Handy Pak #	Qty	Black Box #	Qty	Bulk Carton #	Qty	
40 mm	931	28.14	—	—	—	—	609-500	25	B609-500	200	
50 mm	931	32.89	—	—	—	—	609-502	25	B609-502	180	
60 mm	931	37.02	—	—	—	—	609-504	25	B609-504	150	
70 mm	931	40.58	—	—	—	—	609-506	25	B609-506	130	
80 mm	931	44.90	—	—	—	—	609-508	25	B609-508	100	
90 mm	931	48.94	—	—	—	—	609-509	25	—	—	

ISO Extra Fine Thread

ZINC PLATED

Diameter-Pitch: M20-1.50							Across Flats: 30 Height: 12.5				
Length	DIN	Approx. Weight (lb) /100 pcs	Clamshell #	Qty	Handy Pak #	Qty	Black Box #	Qty	Bulk Carton #	Qty	
40 mm	931	35.90	—	—	—	—	609-520	10	—	—	
50 mm	931	40.50	—	—	—	—	609-522	10	B609-522	100	
60 mm	931	46.20	—	—	—	—	609-524	10	B609-524	90	
70 mm	931	51.75	—	—	—	—	609-526	10	B609-526	80	
80 mm	931	57.20	—	—	—	—	609-528	10	B609-528	70	
90 mm	931	62.43	—	—	—	—	609-529	10	B609-529	65	
100 mm	931	73.50	—	—	—	—	609-530	10	B609-530	60	

610
Series

paulin[®] METRIC HEX HEAD CAP SCREWS

PART CLASS #
806BU | DIN 933 = ISO 4017 Fully Threaded
806AI | DIN 931 = ISO 4014 Partially Threaded

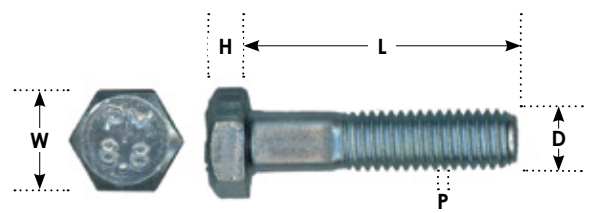

A/F = Across Flats (**W**) **W** = Width **H** = Height **L** = Length **D** = Diameter **P** = Pitch

ORDER BY ITEM (PACKAGE) NUMBER

ISO Fine Thread

— Product not available in this pack size

ZINC PLATED											
Diameter-Pitch: M8-1.00							Across Flats: 13 Height: 5.3				
Length	DIN	Approx. Weight (lb) /100 pcs	Clamshell #	Qty	Handy Pak #	Qty	Black Box #	Qty	Bulk Carton #	Qty	
40 mm	931	4.00	009-233	5	—	—	610-070	25	—	—	

ISO Extra Fine Thread

ZINC PLATED											
Diameter-Pitch: M10-1.00							Across Flats: 16 Height: 6.4				
Length	DIN	Approx. Weight (lb) /100 pcs	Clamshell #	Qty	Handy Pak #	Qty	Black Box #	Qty	Bulk Carton #	Qty	
20 mm	931	5.32	—	—	024-170	4	610-366	25	—	—	
25 mm	931	4.00	—	—	024-171	3	610-368	25	—	—	
30 mm	931	6.00	—	—	024-172	3	610-370	25	—	—	
40 mm	931	7.14	—	—	024-174	3	610-372	25	—	—	
50 mm	931	8.88	—	—	024-176	3	610-374	25	—	—	

Diameter-Pitch: M10-1.25							Across Flats: 16 Height: 6.4				
Length	DIN	Approx. Weight (lb) /100 pcs	Clamshell #	Qty	Handy Pak #	Qty	Black Box #	Qty	Bulk Carton #	Qty	
30 mm	931	5.50	009-156	1	—	—	—	—	—	—	
40 mm	931	4.00	009-157	1	—	—	610-090	25	—	—	
50 mm	931	7.50	009-158	1	—	—	—	—	—	—	

Diameter-Pitch: M12-1.25							Across Flats: 18 Height: 7.5				
Length	DIN	Approx. Weight (lb) /100 pcs	Clamshell #	Qty	Handy Pak #	Qty	Black Box #	Qty	Bulk Carton #	Qty	
30 mm	931	8.80	009-162	1	024-184	2	610-414	25	—	—	
40 mm	931	10.60	009-163	1	024-186	2	610-416	25	—	—	
50 mm	931	12.54	009-164	1	024-188	2	610-418	25	—	—	