

## Bendix® DS-1™ Combined Stop Light Switch Double Check Valve

- Obsolete - no longer available
- Changeover kits include a double check valve and a stoplight switch
- Field Maintenance Kit 276142

V.M.R.S. 13-010-038

Obsolete Pc. No.	A Male P.T.	B Female P.T.	C Female P.T.	D Female P.T.	Changeover Kit Pc No.	Comments
228050N	1/2"	1/4"	1/4"	—	K108140	—
228165N	3/8"	1/4"	1/4"	—	K108141	—
228520N	1/2"	3/8"	1/4"	—	K108140	Note 1
229493	1/2"	1/4"	1/4"	1/4"	K108140	Note 2

Note 1: Coupling required to facilitate installation.

Note 2: The Bendix® DS-1™ double check valve and stoplight switch contains port D — a 1/4" female pipe thread. This port is not included on the Bendix® DC-4® check valve replacement. An additional coupling may be needed to facilitate this changeover.

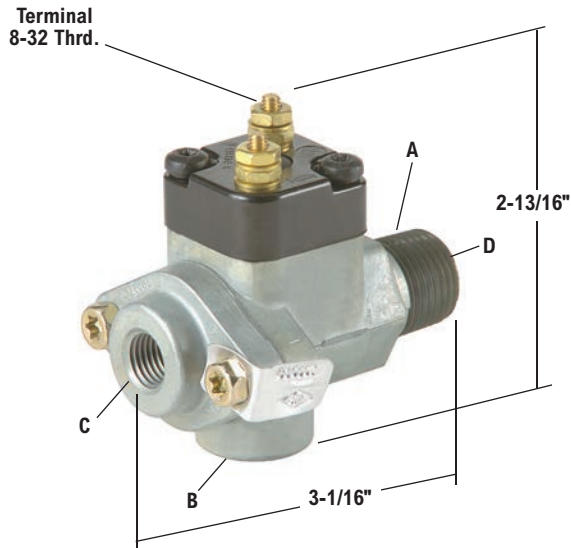

Maintenance Kit Pc. No. 276142

## Bendix® DS-2™ Combined Stop Light Switch Double Check Valve

- Obsolete - No longer available.
- Changeover kits include a double check valve and a stoplight switch

V.M.R.S. 13-010-038

[SD-06-1804](#)

Obsolete Pc. No.	A Male P.T.	B Female P.T.	C Female P.T.	D Female P.T.	E Terminal Thread	Changeover Kit Pc No.	Comments
286452N	3/8"	3/8"	3/8"	—	8-32	K108142	—
286453N	3/8"	3/8"	3/8"	—	10-32	K108143	
286704	—	3/8"	3/8"	3/8"	10-32	K108143	Note 1
287287N	—			3/8"	10-32	K108143	Note 1
5010488N	3/8"			—	10-32	K108143	

Note 1: Coupling required to facilitate installation.

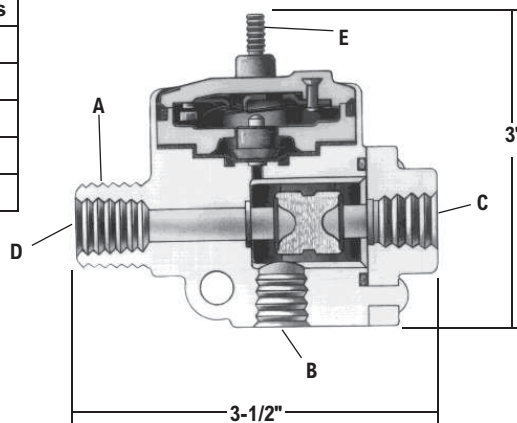

## Bendix® SL-3™ Stop Light Switch

V.M.R.S. 34-002-008

[i SD-06-1800](#)

<b>Service New Pc. No.</b>
226262N

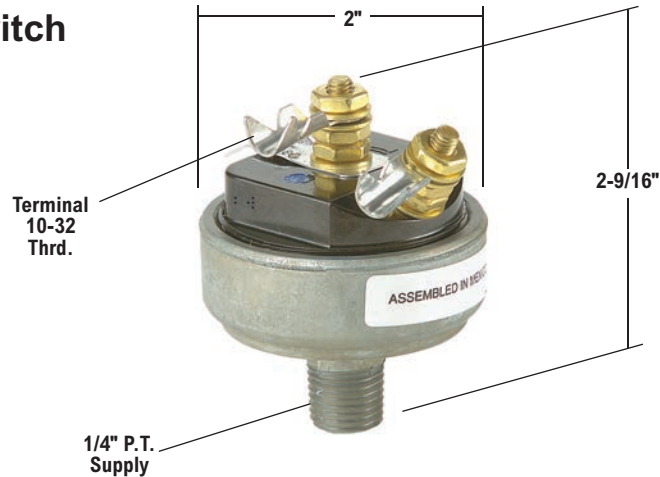

## Bendix® SL-4™ Stop Light Switch

V.M.R.S. 34-002-008

[i SD-06-1800](#)

Service New Pc. No.	A Pipe Thread	Fig. No.
228687N	3/8"	1
228688	1/4"	2
274746N	1/4"	1

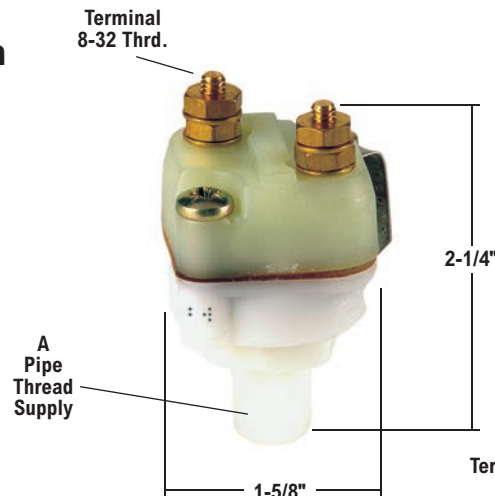

Fig. 1

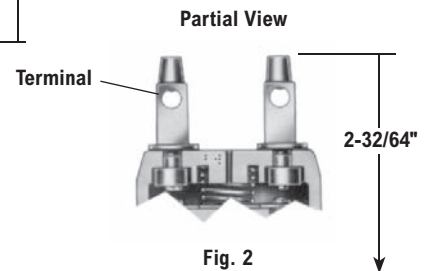

Fig. 2

## Bendix® SL-5™ Stop Light Switch

• Obsolete and superseded by Bendix SL-4 stop light switch

V.M.R.S. 34-002-008

[i SD-06-1804](#)

Obsolete Pc. No.	Service Replacement Bendix SL-4 Stop Light Switch Pc. No.
286392N	K101996
286404N	K101997

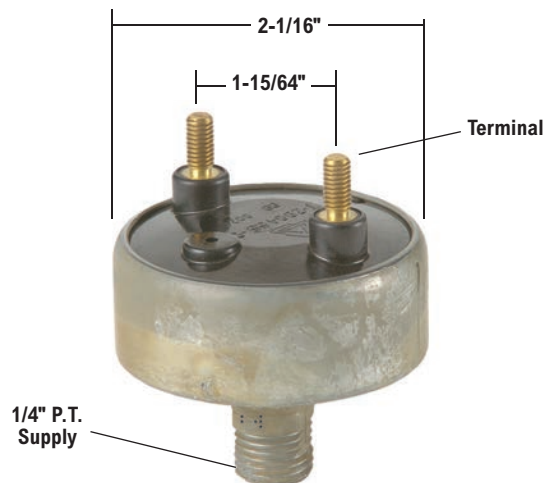

## Bendix® LP-2™ Low Pressure Indicator

V.M.R.S. 03-001-037

[SD-06-1600](#)

Service New Pc. No.	Cut-Out Pressure P.S.I.	Remarks
223578N	60 + 5 - 0	
224044	70 ± 6	Without Cable Terminal
288408	60 ± 6	Weatherproof

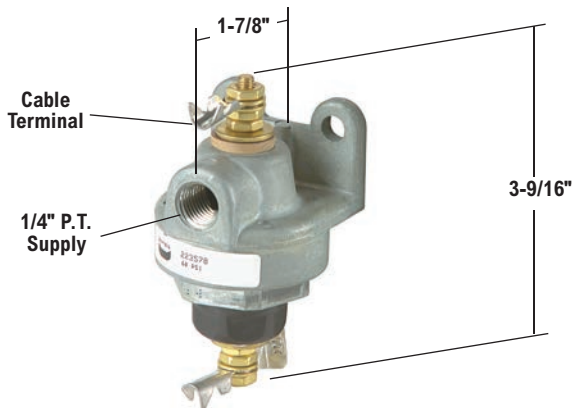

## Bendix® LP-3™ Low Pressure Indicator

V.M.R.S. 03-001-037

[SD-06-1600](#)

### Single Terminal

Service New Pc. No.	Cut-Out Pressure P.S.I.	A Pipe Thread
*104246N	66 ± 6	1/4"
279416N	60 ± 6	1/4"
279472	75 ± 6	1/4"
280530N	70 ± 6	1/4"
289397N	75 ± 6	1/8"

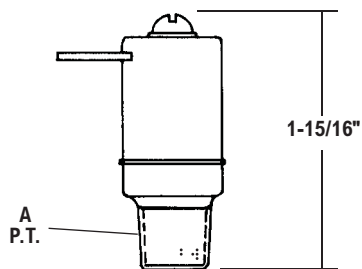

\*Push on terminal

### Double Terminal

Service New Pc. No.	Cut-Out Pressure P.S.I.	A Pipe Thread	Comments
228750N	60 ± 6	1/4"	
**275083N	-	1/4"	
276599N	30 ± 3	1/4"	
277155N	50 ± 5	1/4"	
*280743N	60 ± 6	1/4"	w/o cable terminal
284793N	80 ± 6	1/4"	w/o cable terminal
284833N	70 ± 6	1/4"	w/o cable terminal
283029N	60 ± 6	1/4"	w/o cable terminal
288522	66 ± 6	1/4"	w/o cable terminal

\*\*Pc. No. 275083N has a cut-in pressure of 75 ± 6 PSI

