

BLO-GUNS
100 SERIES

KITS & FAUCETS
200/300 SERIES

TIRE HARDWARE
400/1400 SERIES

INFLATOR GAGES
500 SERIES

FITTINGS & HOSES
600/1600 SERIES

s-174KIT

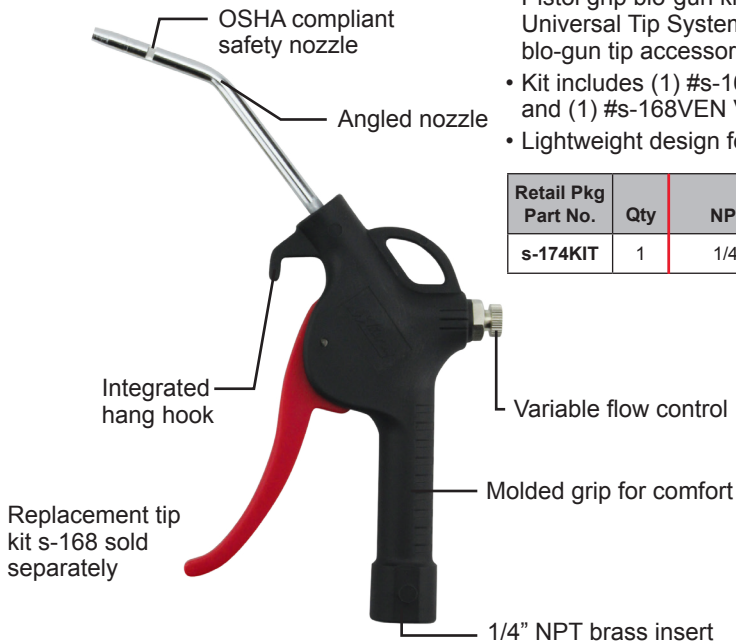

Replacement tip kit s-168 sold separately

PISTOL GRIP BLO-GUN KIT w/ KWIK-CHANGE® UNIVERSAL TIP SYSTEM

- Pistol grip blo-gun kit comes complete with our KWIK-CHANGE® Universal Tip System. This system connects any 1/8" NPS or 6mm blo-gun tip accessory to your blo-gun using our universal adapter
- Kit includes (1) #s-168ADP adapter, (1) #s-168RUB rubber tip and (1) #s-168VEN Venturi safety tip
- Lightweight design for ease of use

Retail Pkg Part No.	Qty	NPT	Max Pressure	SCFM	Nozzle Length
s-174KIT	1	1/4"	90 PSI	16.5	4" Angled

INCLUDES 3 PIECE:

s-167

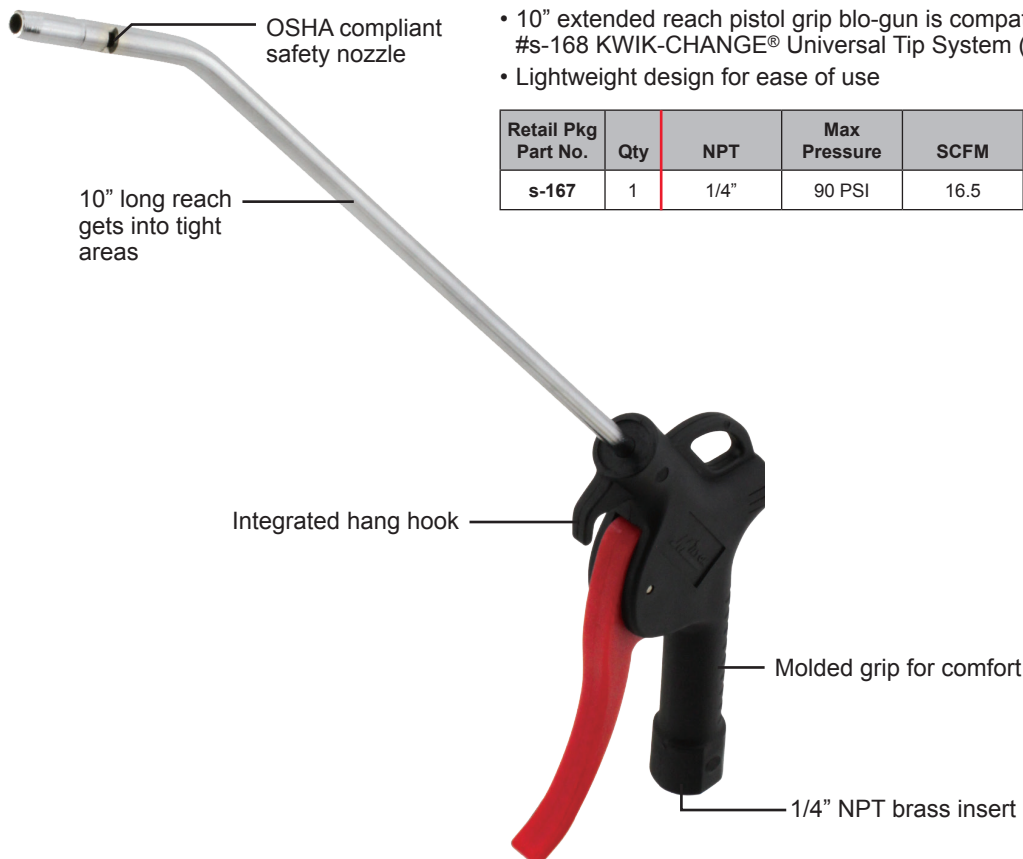

10" long reach gets into tight areas

EXTENDED REACH SAFETY TIP BLO-GUN

- 10" extended reach pistol grip blo-gun is compatible with the #s-168 KWIK-CHANGE® Universal Tip System (not included)
- Lightweight design for ease of use

Retail Pkg Part No.	Qty	NPT	Max Pressure	SCFM	Nozzle Length
s-167	1	1/4"	90 PSI	16.5	10" Angled

PRO SERIES

s-194KIT

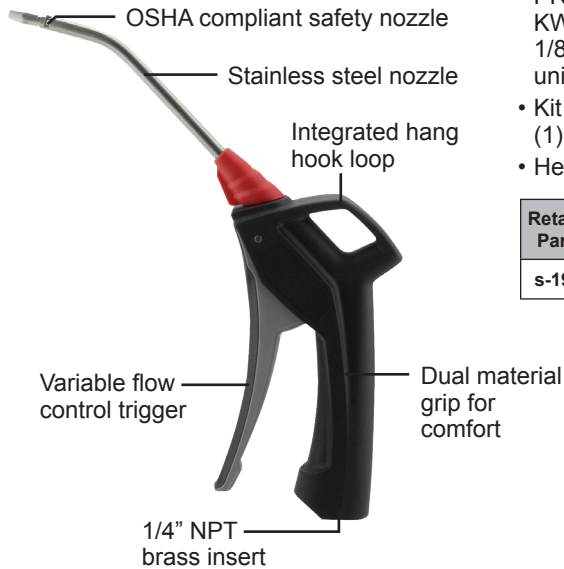

PRO SERIES PISTOL GRIP BLO-GUN KIT w/ KWIK-CHANGE® UNIVERSAL TIP SYSTEM

- PRO SERIES pistol grip blo-gun kit comes complete with our KWIK-CHANGE® Universal Tip System. This system connects any 1/8" NPS or 6mm blo-gun tip accessory to your blo-gun using our universal adapter
- Kit includes (1) #s-168ADP adapter, (1) #s-168RUB rubber tip and (1) #s-168VEN Venturi safety tip
- Heavy-duty, light weight design for ease of use

Retail Pkg Part No.	Qty	NPT	Max Pressure	SCFM	Nozzle Length
s-194KIT	1	1/4"	235 PSI	15.0	5" Angled

INCLUDES 3 PIECE:

KWIK-CHANGE® Universal Tip System Kit
 Connects **ANY** 1/8" NPS blo-gun attachment to select MILTON® blo-guns (See pg 4 for details)

s-168

s-197

EXTENDED REACH SAFETY TIP BLO-GUN

- PRO SERIES extended reach pistol grip blo-gun is compatible with the #s-168 KWIK-CHANGE® Universal Tip System (not included)
- Heavy-duty, light weight design for ease of use

Retail Pkg Part No.	Qty	NPT	Max Pressure	SCFM	Nozzle Length
s-197	1	1/4"	235 PSI	15.0	11" Straight

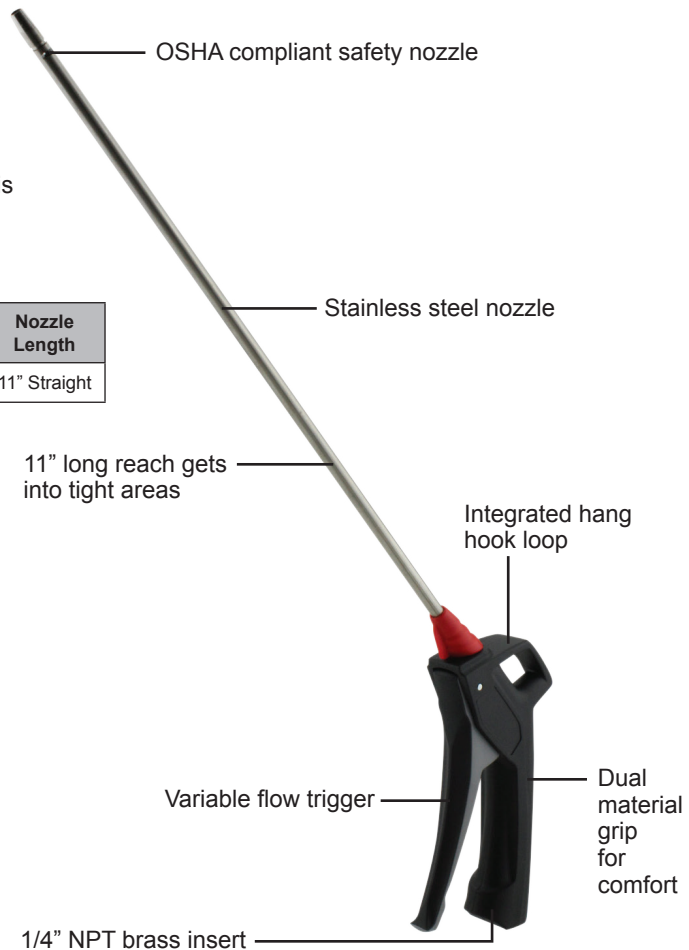

BLO-GUNS
100 SERIES

KITS & FAUCETS
200/300 SERIES

TIRE HARDWARE
400/1400 SERIES

INFLATOR GAGES
500 SERIES

FITTINGS & HOSES
600/1600 SERIES

100 SERIES

BLO-GUNS

BLO-GUNS
100 SERIES

s-168

s-168 KWIK-CHANGE® Universal Tip System Kit
Connects **ANY** 1/8" NPS blo-gun attachment to select MILTON® blo-guns

s-168RUB
Blo-Gun Rubber Tip

s-168ADP
Universal Blo-Gun Tip Adapter

s-168VEN
Blo-Gun Venturi Tip

ONE
Adapter

Multiple
POSSIBILITIES

BLO-GUN ACCESSORIES

**s-168 • s-168ADP
s-168RUB • s-168VEN**



KWIK-CHANGE® UNIVERSAL TIP SYSTEM KITS

- Connects ANY 1/8" NPS blo-gun attachment to select MILTON® Blo-Guns
- Blo-gun nozzle tips that are compatible with your KWIK-CHANGE® Universal Tip System

Part No.	s-168
Qty	Description
1	#s-168ADP Universal Blo-Gun Tip Adapter
1	#s-168RUB Blo-Gun Rubber Tip
1	#s-168VEN Blo-Gun Venturi Safety Tip



Retail Pkg Part No.	Qty	NPS
s-168ADP	1	1/8"
s-168RUB	1	
s-168VEN	1	

KITS & FAUCETS
200/300 SERIES

TIRE HARDWARE
400/1400 SERIES

INFLATOR GAGES
500 SERIES

FITTINGS & HOSES
600/1600 SERIES

s-160X5A • s-160X5P



X5 AIR MULTIPLIER™ BLO-GUN NOZZLE

- Fits ANY 6mm or 1/8" NPS screw-on blo-gun nozzle
- Multiplies CFM output by drawing in outside air

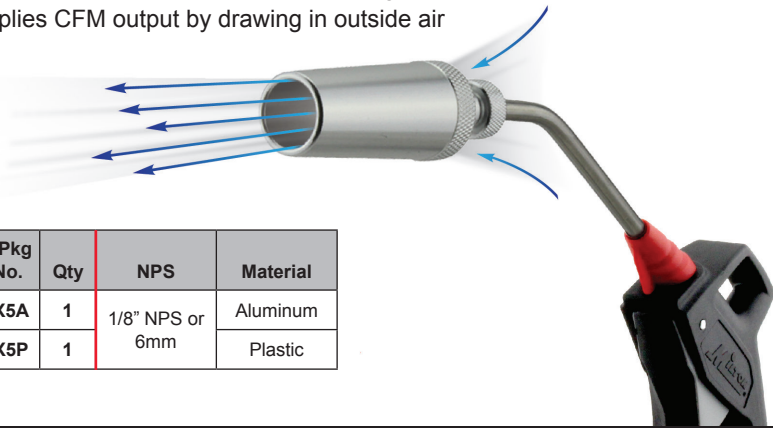

Retail Pkg Part No.	Qty	NPS	Material
s-160X5A	1	1/8" NPS or 6mm	Aluminum
s-160X5P	1		Plastic

SAFETY BLO-GUNS

107



s-107

Safety Button Blo-Gun

- OSHA compliant when dead ended (static pressure)
- Compact, hand-held unit can be used anywhere with compressed air

Boxed Pkg Part No.	Retail Pkg Part No.	Qty	Max Inlet Pressure	SCFM @ 100 PSI	Air Inlet	Nozzle Thread	Body Material	OSHA Compliant
107	s-107	1	150 PSI	11.4	1/4" NPT	5/16"-24	Zinc	YES

s-120



s-120

Safety Lever Blo-Gun

- OSHA compliant when dead ended (static pressure)
- For use with extensions and other 1/8" NPS attachments
- Extra large hang-up hook for easy storage

Bulk Pkg Part No.	Retail Pkg Part No.	Qty	Max Inlet Pressure	SCFM @ 100 PSI	Air Inlet	Nozzle Thread	Body Material	OSHA Compliant
120BK	s-120	1	150 PSI	10.6	1/4" NPT	1/8"-27	Zinc	YES

122 • 123



123

Brass Blo-Gun Extensions

- Fits MILTON® blo-gun models #120, #160, or any other 6mm or 1/8" NPS nozzle blo-gun using the #s-168ADP KWIK-CHANGE® accessory adapter

Bulk Pkg Part No.	Nozzle Thread	Extension Length
122	1/8"-27	6"
123		10"

131 • 133 • 134



131

133

134

Extended Safety Lever Blo-Gun

- OSHA compliant - Four safety by-pass holes allow air to escape if end is blocked
- By-pass holes do not interfere with normal air flow
- Discharges same air volume as full-flow blo-guns, while maintaining nozzle pressure
- #133 & #134 bent to an angle to clean out blind holes and offer convenient use on long reach applications

Boxed Pkg Part No.	Max Inlet Pressure	Nozzle Length	SCFM @ 100 PSI	Air Inlet	Nozzle Thread	Body Material
131	150 PSI	4" Straight	5.5	1/4" NPT	1/2"-27	Zinc Alloy
133		10" Angled	4.5			
134		15" Angled				

Classified by UL to OSHA standards 29CFR1910.95 and 29CFR1910.242(b)

BLO-GUNS
100 SERIES

KITS & FAUCETS
200/300 SERIES

TIRE HARDWARE
400/1400 SERIES

INFLATOR GAGES
500 SERIES

FITTINGS & HOSES
600/1600 SERIES

132



132

Volume Safety Blo-Gun

- Special Venturi holes in extension tube greatly increase air volume while maintaining OSHA required nozzle pressure
- Venturi holes allow air to escape if extension end is blocked

Boxed Pkg Part No.	Max Inlet Pressure	SCFM @ 100 PSI	Air Inlet	Nozzle Thread	Body Material	OSHA Compliant
132	150 PSI	18.0	1/4" NPT	1/2"-27	Zinc Alloy	YES

Classified by UL to OSHA standards 29CFR1910.95 and 29CFR1910.242(b)

148



148

Compact Lever Blo-Gun

- Compact and versatile blo-gun comes with both a safety Venturi nozzle and a rubber tip nozzle
- Works with brass tube extensions and 1/8" NPS attachments
- Hang hook included for ease of storage

Bulk Pkg Part No.	Retail Pkg Part No.	Qty	Max Inlet Pressure	Air Inlet	Nozzle Thread	Body Material	OSHA Compliant
148BK	s-148	1	150 PSI	1/4" NPT	1/8"-27	Zinc	YES (with Venturi Tip Only)

149



149

Super-Volume Safety Lever Blo-Gun

- Special Venturi holes in extension tube greatly increase air volume while maintaining OSHA required nozzle pressure
- Venturi holes allow air to escape if extension end is blocked
- Aluminum nozzle extension

Boxed Pkg Part No.	Max Inlet Pressure	SCFM @ 100 PSI	Air Inlet	Nozzle Thread	Body Material	OSHA Compliant
149	150 PSI	23.6	1/4" NPT	1/2"-27	Zinc Alloy	YES

150

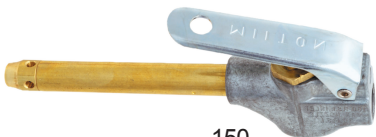

150

Full-Flow Safety Lever Blo-Gun

- OSHA compliant when dead ended (static pressure)
- Full flow control

Bulk Pkg Part No.	Boxed Pkg Part No.	Retail Pkg Part No.	Qty	Max Inlet Pressure	SCFM @ 100 PSI	Air Inlet	Nozzle Thread	Body Material	OSHA Compliant
150BK	150	s-150	1	150 PSI	10.0	1/4" NPT	7/16"-27	Zinc	YES

158 • 159



Extended Reach Lever Blo-Guns

- Multi-function blo-gun comes with both a Venturi nozzle and rubber tip nozzle
- OSHA compliant when using Venturi tip
- Extension is bent to access hard to reach areas such as motors, machinery, transmissions, combines, and hidden areas

Bulk Pkg Part No.	Retail Pkg Part No.	Qty	Extension Length	Max Inlet Pressure	SCFM @ 100 PSI	Air Inlet	Nozzle Thread	Body Material	OSHA Compliant
158BK	158	1	2'	150 PSI	Venturi Tip - 10.5 Rubber Tip - 11.6	1/4" NPT	7/16"-27	Zinc	YES (with Venturi Tip Only)
159BK	159	1	4'						

s-115 • s-116 • s-117 • s-118



s-115 s-116 s-117 s-118

ADJUSTABLE ALUMINUM POCKET BLO-GUNS

- Easy grip two finger control to adjust from full volume air flow to complete shut off
- Knurled grip for secure handling even with oily or greasy fingers
- Always keep one handy with included shirt pocket clip

Bulk Pkg Part No.	Retail Pkg Part No.	Qty	Connection	Max Inlet Pressure	SCFM @ 100 PSI	Air Inlet	Body Material	OSHA Compliant
115BK	s-115	1	M-Style® (Industrial)	150 PSI	15.9	M-Style®	Aluminum	No
	s-116	1	A-Style (ARO)			A-Style		
	s-117	1	T-Style (Tru-flate)			T-Style		
	s-118	1	L-Style (Lincoln)			L-Style		

151



Control Valve

- Lever control 2-way valve for use on air, fluid & vacuum lines
- Perfect for tire changing machines
- Stainless steel spring, synthetic washer
- Max temperature: 200°F

Boxed Pkg Part No.	Max Inlet Pressure	SCFM @ 100 PSI	Product Specs			OSHA Compliant
			Air Inlet	Air Outlet	Body Material	
151	150 PSI	24.5	1/4" NPT	1/4" NPT	Zinc Alloy	No

152



Rubber Tip Nozzle

- Replacement tip for #153, #154, #158 and #159 blo-guns
- For use where leak-proof connection is required when blowing out fluid lines
- O-ring seals create an air-tight connection
- A must where metal tip could mar delicate finish in molds or paints

Bulk Pkg Part No.	Boxed Pkg Part No.	Retail Pkg Part No.	Qty	Max Inlet Pressure	Product Specs Nozzle Thread	Body Material	OSHA Compliant
152BK	152	s-152	1	150 PSI	7/16"-27 and 1/8" NPS	Nitrile Rubber	No

BLO-GUNS
100 SERIES

KITS & FAUCETS
200/300 SERIES

TIRE HARDWARE
400/1400 SERIES

INFLATOR GAGES
500 SERIES

FITTINGS & HOSES
600/1600 SERIES

153 • s-154



s-153



s-154

Rubber Tip Lever Blo-Guns

- Rubber tip blo-guns are perfect to use where leak proof connection is required when blowing out fluid lines
- Non-marring rubber tip protects from damaging molds or painted surfaces

Bulk Pkg Part No.	Retail Pkg Part No.	Qty	Max Inlet Pressure	SCFM @ 100 PSI	Air Inlet	Product Specs		Body Material	OSHA Compliant
						Nozzle Thread	Nozzle Angle		
153BK	s-153	1	150 PSI	11.4	1/4" NPT	1/8"-27	Straight	Zinc	No
	s-154	1					45° Angle		

SIPHON SPRAY BLO-GUNS

155

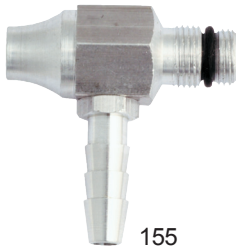

155

Siphon Spray Blo-Gun Nozzle

- O-ring seal creates air-tight connection
- Dual thread design permits use on all blo-guns with 7/16"-27 and 1/8" NPS

Boxed Pkg Part No.	Nozzle Thread	Product Specs	
		Body Material	OSHA Compliant
155	7/16"-27 and 1/8" NPS	Aluminum	No

For Use with Liquids

s-156 • 157



s-156

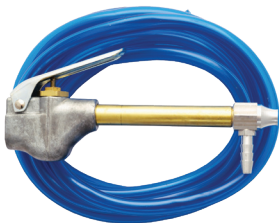

157

Siphon Spray Blo-Gun & Kit

- Excellent for degreasing engines, garage bays and parts, spraying livestock, plants and flowers
- Perfect for rust proofing tools and machinery and lubricating parts and engines
- #s-157 kit comes complete with #156 blo-gun and 8' of tubing

For Use with Liquids

Bulk Pkg Part No.	Retail Pkg Part No.	Qty	Max Inlet Pressure	SCFM @ 100 PSI	Air Inlet	Product Specs			8' of Tubing
						Nozzle Thread	Body Material	OSHA Compliant	
	s-156	1	150 PSI	14.0	1/4" NPT	1/8"-27	Zinc	No	No
157BK	s-157	1							YES

161 • 162

Extended Reach Siphon Spray Blo-Guns

• Kits come complete with blo-gun and length of tubing

Bulk Pkg Part No.	Max Inlet Pressure	SCFM @ 100 PSI	Air Inlet	Nozzle Thread	Product Specs			OSHA Compliant
					Body Material	Nozzle Length	Tubing Length	
161	150 PSI	11.3	1/4" NPT	1/8"-24	Zinc	2'	12' x 1/4" OD	No
162						4'	15' x 1/4" OD	

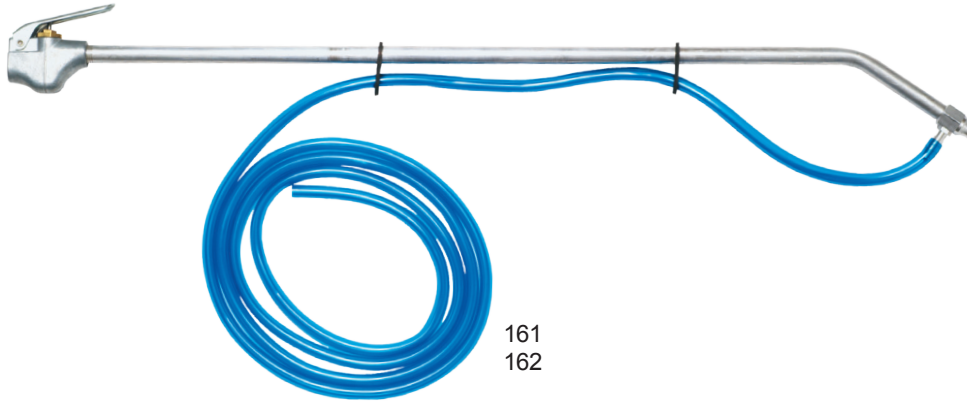

For Use with Liquids

161
162

160

PISTOL GRIP BLO-GUN

- Pistol style multi-use blo-gun
- Accepts Milton® #122 (6") and #123 (10") extensions and other 1/8" NPS attachment
- OSHA compliant with use of included Venturi tip
- Integrated hang hook for ease of storage



160

Bulk Pkg Part No.	Retail Pkg Part No.	Qty	Max Inlet Pressure	SCFM @ 100 PSI	Air Inlet	Product Specs		OSHA Compliant
						Nozzle Thread	Body Material	
160BK	s-160	1	150 PSI	10.0	1/4" NPT	1/8"-27	Chrome Plated Zinc	YES (with Safety Tip Only)

s-177

11" EXTENDED REACH PISTOL GRIP BLO-GUN

- Bent 11" nozzle allows direct access to hard to reach places
- Non-marring plastic tip, and integrated hang hook for storage



s-177

Retail Pkg Part No.	Qty	Max Inlet Pressure	SCFM @ 100 PSI	Air Inlet	Product Specs		OSHA Compliant
					Body Material	Nozzle Length	
s-177	1	125 PSI	11.0	1/4" NPT	Nylon	11"	No

BLO-GUNS
100 SERIES

KITS & FAUCETS
200/300 SERIES

TIRE HARDWARE
400/1400 SERIES

INFLATOR GAGES
500 SERIES

FITTINGS & HOSES
600/1600 SERIES

s-163



s-163

PISTOL GRIP BLO-GUN

- Simple, functional, economical
- 4" angled nozzle
- Integrated hang hook and loop

Retail Pkg Part No.	Qty	NPT
s-163	1	1/4"

s-164



s-164

RUBBER TIP BLO-GUN

- 4 1/2" angled nozzle
- Non-marring rubber tip
- Brass insert inlet
- Integrated hang hook and loop
- Contoured comfort grip

Retail Pkg Part No.	Qty	NPT
s-164	1	1/4"

s-160SIL



s-160SIL

BLO-GUN SILENCER

- Fits all 6mm blo-gun nozzles
- Reduces decibel (db) levels up to 15% - meets OSHA compliancy when dead headed (static pressure)
- Soft non-marring silencer tip prevents damage to work surface

Retail Pkg Part No.	Qty	Nozzle Diameter
s-160SIL	1	6mm

s-160CHIP



s-160CHIP

BLO-GUN DEFLECTOR SHIELD

- Polycarbonate deflector shield reduces accidental blow back
- Fits any blo-gun with 6mm diameter nozzle
- Set screw secures deflector shield to nozzle

Retail Pkg Part No.	Qty	Nozzle Diameter
s-160CHIP	1	6mm

TURBO PISTOL GRIP BLO-GUNS

- Meets OSHA standard 1910.242(B)
- Aluminum body is lightweight and durable
- Maximum flow for easy clean-up and blow off of even the heaviest debris
- Simple trigger-controlled air flow

s-181



s-181

Turbo Pistol Grip Blo-Gun

- Includes adjustable nozzle (s-181 and s-182) and integrated hang hole
- Nozzle thread: 1/2"-27

Retail Pkg Part No.	Qty	Max Inlet Pressure	SCFM @ 125 PSI	Product Specs			OSHA Compliant
				Air Inlet	Body Material		
s-181	1	230 PSI	42.0	3/8" NPT	Aluminum	YES	

s-182



s-182

Turbo Extended Reach Pistol Grip Blo-Gun

- Includes adjustable nozzle (s-181 and s-182) and integrated hang hole
- Nozzle thread: 1/2"-27

Retail Pkg Part No.	Qty	Max Inlet Pressure	SCFM @ 125 PSI	Air Inlet	Product Specs		OSHA Compliant
					Body Material	Nozzle Length	
s-182	1	230 PSI	40.0	3/8" NPT	Aluminum	10"	YES

s-183



Adjustable

High-volume

Fan spray

s-183

3-pc Turbo Blo-Gun Nozzle Kit

- For use with s-181 and s-182 turbo blo-guns
- Thread size: 1/2"-27

Part No.	s-183
Qty	Description
1	Adjustable Nozzle
1	High-Volume Nozzle
1	Fan Spray Nozzle

s-184

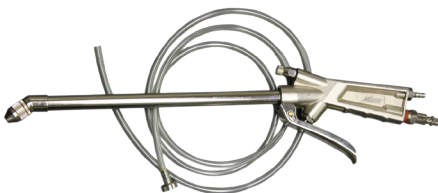

s-184

TURBO BLO-GUN ENGINE CLEANER

- Includes M-Style® plug

Retail Pkg Part No.	Qty	Max Inlet Pressure	SCFM @ 125 PSI	Air Inlet	Product Specs		OSHA Compliant
					Body Material	Tubing Length	
s-184	1	225 PSI	10.0	1/4" NPT	Aluminum	5' x 1/4" OD	YES

BLO-GUNS
100 SERIES

KITS & FAUCETS
200/300 SERIES

TIRE HARDWARE
400/1400 SERIES

INFLATOR GAGES
500 SERIES

FITTINGS & HOSES
600/1600 SERIES