



HYDRAULIC HOSE FOR POLARSEAL® II (ACB & ACC) COUPLINGS



| |
|-------------------------------------|
| EQUIPMENT |
| HOSE/CPLG. SELECTION |
| G8K COUPLINGS |
| GLOBALSPIRAL COUPLINGS |
| STAINLESS STEEL SPIRAL |
| MEGACRIMP COUPLINGS |
| STAINLESS STEEL BRAID |
| POWER CRIMP COUPLINGS |
| FIELD ATTACHABLE G1 & G2 COUPLINGS |
| FIELD ATTACHABLE C5 COUPLINGS |
| C14 COUPLINGS |
| GL COUPLINGS |
| GLX COUPLINGS |
| PCTS THERMOPLASTIC COUPLINGS |
| POLARSEAL COUPLINGS (ACA) |
| POLARSEAL II COUPLINGS (ACC) |
| POLARSEAL II COUPLINGS (ACB) |
| POWER STEERING |
| ADAPTERS |
| QUICK DISCONNECT COUPLERS |
| BALL VALVES |
| LIVE SWIVEL |
| ASSEMBLY FABRICATION |
| ACCESSORIES |
| EQUIPMENT AND PARTS |
| KITS |
| AIR BRAKE HOSE ASSY |
| BRASS |

The Gates eCrimp program is a web based utility which allows users and distributors of Gates hydraulic and industrial hose products to find and print the most up to date crimp specifications with nothing more than an internet browser.

This program can be used to find crimp data for all Gates crimpers. Custom result may be printed by selecting the crimper, hose and coupling. Optionally results may also be limited by die set and working pressure.

The eCrimp web application can be directly accessed from a web browser by entering <http://eCrimp.Gates.com> for the website.

The eCrimp mobile app is available for download for the iPhone and iPad from the App Store.



| |
|-------------------------------------|
| EQUIPMENT |
| HOSE/CPLG. SELECTION |
| G8K COUPLINGS |
| GLOBAL SPIRAL COUPLINGS |
| STAINLESS STEEL SPIRAL |
| MEGACRIMP COUPLINGS |
| STAINLESS STEEL BRAID |
| POWER CRIMP COUPLINGS |
| FIELD ATTACHABLE G1 & G2 COUPLINGS |
| FIELD ATTACHABLE C5 COUPLINGS |
| C14 COUPLINGS |
| GL COUPLINGS |
| GLX COUPLINGS |
| PCTS THERMOPLASTIC COUPLINGS |
| POLARSEAL COUPLINGS (ACA) |
| POLARSEAL II COUPLINGS (ACC) |
| POLARSEAL II COUPLINGS (ACB) |
| POWER STEERING |
| ADAPTERS |
| QUICK DISCONNECT COUPLERS |
| BALL VALVES |
| LIVE SWIVEL |
| ASSEMBLY FABRICATION |
| ACCESSORIES |
| EQUIPMENT AND PARTS |
| KITS |
| AIR BRAKE HOSE ASSY |
| BRASS |

Male Flareless Assembly

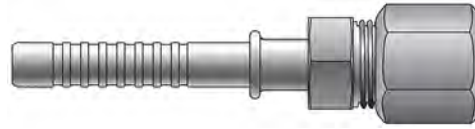

| Part No. | Descr. | Prod. No. | Standard Pack |
|-------------|-------------|------------|---------------|
| G46510-0606 | 6ACC-6MFA | 7332-51355 | 1 |
| G46510-0808 | 8ACC-8MFA | 7332-51365 | 1 |
| G46510-1010 | 10ACC-10MFA | 7332-51375 | 1 |
| G46510-1212 | 12ACC-12MFA | 7332-51385 | 1 |

Male Flareless Assembly - 90° Bent Tube

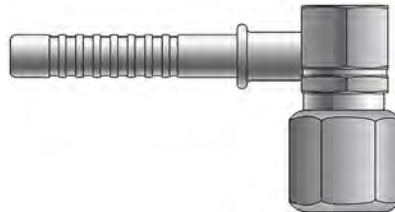

| Part No. | Descr. | Prod. No. | Standard Pack |
|-------------|---------------|------------|---------------|
| G46511-0606 | 6ACC-6MFA90 | 7332-51395 | 1 |
| G46511-0808 | 8ACC-8MFA90 | 7332-51405 | 1 |
| G46511-1010 | 10ACC-10MFA90 | 7332-51415 | 1 |
| G46511-1212 | 12ACC-12MFA90 | 7332-51425 | 1 |

Weld On Hose End

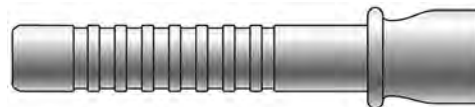

| Part No. | Descr. | Prod. No. | ⊕ |
|-------------|-------------|------------|-------|
| | | | " |
| G46527-0606 | 6ACC-6FBO | 7332-51165 | 5/16 |
| G46527-0808 | 8ACC-8FBO | 7332-51175 | 13/32 |
| G46527-1010 | 10ACC-10FBO | 7332-51185 | 1/2 |
| G46527-1210 | 12ACC-10FBO | 7332-51345 | 5/8 |
| G46527-1212 | 12ACC-12FBO | 7332-51195 | 5/8 |
| G46527-1216 | 12ACC-16FBO | 7332-51205 | 5/8 |



Splicer



| Part No. | Descr. | Prod. No. | ⊖ | 🌀 |
|-------------|-------------|------------|-------|----|
| | | | " | " |
| G46535-0606 | 6ACC-6HLE | 7332-50915 | 5/16 | 6 |
| G46535-0808 | 8ACC-8HLE | 7332-50925 | 13/32 | 8 |
| G46535-1010 | 10ACC-10HLE | 7332-50935 | 1/2 | 10 |
| G46535-1212 | 12ACC-12HLE | 7332-50945 | 5/8 | 12 |

T Splicer



| Part No. | Descr. | Prod. No. | ⊖ | 🌀 |
|-------------|--------------|------------|-------|----|
| | | | " | " |
| G46539-0606 | 6ACC-6HLET | 7332-51085 | 5/16 | 6 |
| G46539-0808 | 8ACC-8HLET | 7332-51095 | 13/32 | 8 |
| G46539-1010 | 10ACC-10HLET | 7332-51105 | 1/2 | 10 |
| G46539-1212 | 12ACC-12HLET | 7332-51115 | 5/8 | 12 |

Y Splicer

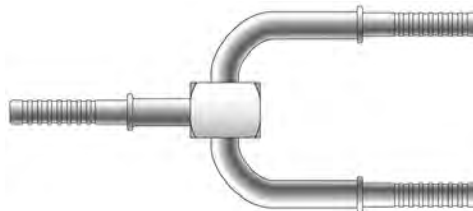

| Part No. | Descr. | Prod. No. | ⊖ | 🌀 |
|-------------|--------------|------------|-------|----|
| | | | " | " |
| G46542-0808 | 8ACC-8HLEY | 7332-51135 | 13/32 | 8 |
| G46542-1010 | 10ACC-10HLEY | 7332-51145 | 1/2 | 10 |
| G46542-1212 | 12ACC-12HLEY | 7332-51155 | 5/8 | 12 |

| |
|-------------------------------------|
| EQUIPMENT |
| HOSE/CPLG. SELECTION |
| G8K COUPLINGS |
| GLOBALSPIRAL COUPLINGS |
| STAINLESS STEEL SPIRAL |
| MEGACRIMP COUPLINGS |
| STAINLESS STEEL BRAID |
| POWER CRIMP COUPLINGS |
| FIELD ATTACHABLE G1 & G2 COUPLINGS |
| FIELD ATTACHABLE C5 COUPLINGS |
| C14 COUPLINGS |
| GL COUPLINGS |
| GLX COUPLINGS |
| PCTS THERMOPLASTIC COUPLINGS |
| POLARSEAL COUPLINGS (ACA) |
| POLARSEAL II COUPLINGS (ACC) |
| POLARSEAL II COUPLINGS (ACB) |
| POWER STEERING |
| ADAPTERS |
| QUICK DISCONNECT COUPLERS |
| BALL VALVES |
| LIVE SWIVEL |
| ASSEMBLY FABRICATION |
| ACCESSORIES |
| EQUIPMENT AND PARTS |
| KITS |
| AIR BRAKE HOSE ASSY |
| BRASS |



| |
|-------------------------------------|
| EQUIPMENT |
| HOSE/CPLG. SELECTION |
| G8K COUPLINGS |
| GLOBAL SPIRAL COUPLINGS |
| STAINLESS STEEL SPIRAL |
| MEGACRIMP COUPLINGS |
| STAINLESS STEEL BRAID |
| POWER CRIMP COUPLINGS |
| FIELD ATTACHABLE G1 & G2 COUPLINGS |
| FIELD ATTACHABLE C5 COUPLINGS |
| C14 COUPLINGS |
| GL COUPLINGS |
| GLX COUPLINGS |
| PCTS THERMOPLASTIC COUPLINGS |
| POLARSEAL COUPLINGS (ACA) |
| POLARSEAL II COUPLINGS (ACC) |
| POLARSEAL II COUPLINGS (ACB) |
| POWER STEERING |
| ADAPTERS |
| QUICK DISCONNECT COUPLERS |
| BALL VALVES |
| LIVE SWIVEL |
| ASSEMBLY FABRICATION |
| ACCESSORIES |
| EQUIPMENT AND PARTS |
| KITS |
| AIR BRAKE HOSE ASSY |
| BRASS |

Male O-Ring - 180° Bent Tube

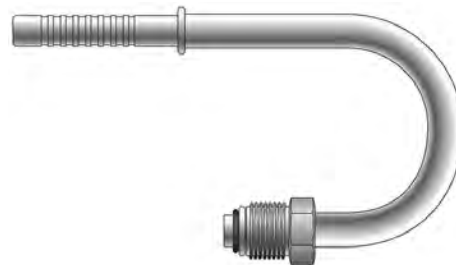

| Part No. | Descr. | Prod. No. | ⊖ | ⌘ |
|-------------|-----------------|------------|------|--------|
| | | | " | " |
| G46578-0606 | 6ACC-6MTON180 | 7332-50895 | 5/16 | 5/8-18 |
| G46578-1010 | 10ACC-10MTON180 | 7332-50905 | 5/8 | 7/8-14 |

Male O-Ring with Switch or Service Port - 90° Bent Tube

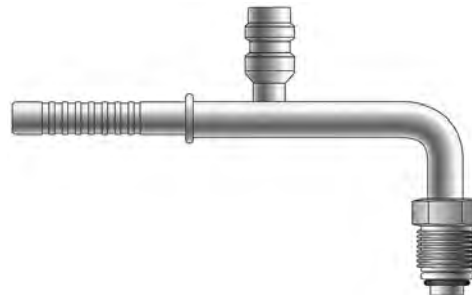

| Part No. | Descr. | Prod. No. | ⊖ | ⌘ |
|--------------|---------------------|------------|-------|--------|
| | | | " | " |
| G46582-0808H | 8ACC-8MTON90134SWPH | 7332-50695 | 13/32 | 3/4-16 |

Male O-Ring

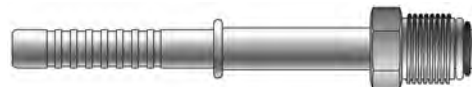

| Part No. | Descr. | Prod. No. | ⊖ | ⌘ |
|-------------|--------------|------------|-------|-----------|
| | | | " | " |
| G46583-0606 | 6ACC-6MTON | 7332-50525 | 5/16 | 5/8-18 |
| G46583-0806 | 8ACC-6MTON | 7332-50585 | 13/32 | 5/8-18 |
| G46583-0808 | 8ACC-8MTON | 7332-50535 | 13/32 | 3/4-16 |
| G46583-1010 | 10ACC-10MTON | 7332-50545 | 1/2 | 7/8-14 |
| G46583-1210 | 12ACC-10MTON | 7332-50595 | 5/8 | 7/8-14 |
| G46583-1212 | 12ACC-12MTON | 7332-50565 | 5/8 | 1 1/16-14 |
| G46583-1610 | 16ACC-10MTON | 7332-50555 | 7/8 | 7/8-14 |
| G46583-1612 | 16ACC-12MTON | 7332-50575 | 7/8 | 1 1/16-14 |



Male O-Ring - 45° Bent Tube



| Part No. | Descr. | Prod. No. | | |
|-------------|----------------|------------|------|--------|
| | | | " | " |
| G46584-0606 | 6ACC-6MTON45 | 7332-50605 | 5/16 | 5/8-18 |
| G46584-1210 | 12ACC-10MTON45 | 7332-50615 | 5/8 | 7/8-14 |

Male O-Ring - 90° Bent Tube

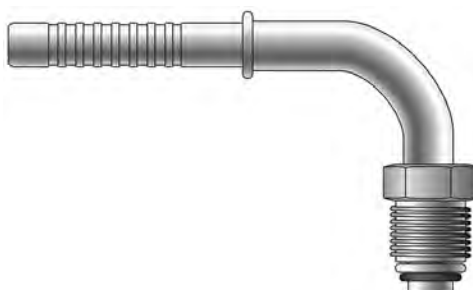

| Part No. | Descr. | Prod. No. | | |
|-------------|----------------|------------|-------|-----------|
| | | | " | " |
| G46585-0606 | 6ACC-6MTON90 | 7332-50625 | 5/16 | 5/8-18 |
| G46585-0806 | 8ACC-6MTON90 | 7332-50665 | 13/32 | 5/8-18 |
| G46585-0808 | 8ACC-8MTON90 | 7332-50635 | 13/32 | 3/4-16 |
| G46585-1008 | 10ACC-8MTON90 | 7332-50675 | 1/2 | 3/4-16 |
| G46585-1010 | 10ACC-10MTON90 | 7332-50645 | 1/2 | 7/8-14 |
| G46585-1210 | 12ACC-10MTON90 | 7332-50685 | 5/8 | 7/8-14 |
| G46585-1212 | 12ACC-12MTON90 | 7332-50655 | 5/8 | 1 1/16-14 |

Straight Female O-Ring with R134 Service Port H

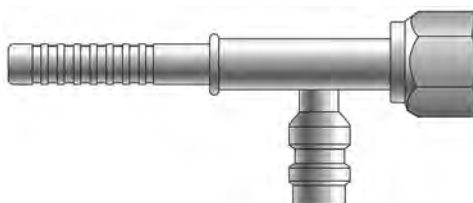

| Part No. | Descr. | Prod. No. | | |
|--------------|------------------|------------|-------|--------|
| | | | " | " |
| G46588-0808H | 8ACC-8FTON134SPH | 7332-50135 | 13/32 | 3/4-16 |

| |
|-------------------------------------|
| EQUIPMENT |
| HOSE/CPLG. SELECTION |
| G8K COUPLINGS |
| GLOBALSPIRAL COUPLINGS |
| STAINLESS STEEL SPIRAL |
| MEGACRIMP COUPLINGS |
| STAINLESS STEEL BRAID |
| POWER CRIMP COUPLINGS |
| FIELD ATTACHABLE G1 & G2 COUPLINGS |
| FIELD ATTACHABLE C5 COUPLINGS |
| C14 COUPLINGS |
| GL COUPLINGS |
| GLX COUPLINGS |
| PCTS THERMOPLASTIC COUPLINGS |
| POLARSEAL COUPLINGS (ACA) |
| POLARSEAL II COUPLINGS (ACC) |
| POLARSEAL II COUPLINGS (ACB) |
| POWER STEERING |
| ADAPTERS |
| QUICK DISCONNECT COUPLERS |
| BALL VALVES |
| LIVE SWIVEL |
| ASSEMBLY FABRICATION |
| ACCESSORIES |
| EQUIPMENT AND PARTS |
| KITS |
| AIR BRAKE HOSE ASSY |
| BRASS |



| |
|-------------------------------------|
| EQUIPMENT |
| HOSE/CPLG. SELECTION |
| G8K COUPLINGS |
| GLOBAL SPIRAL COUPLINGS |
| STAINLESS STEEL SPIRAL |
| MEGACRIMP COUPLINGS |
| STAINLESS STEEL BRAID |
| POWER CRIMP COUPLINGS |
| FIELD ATTACHABLE G1 & G2 COUPLINGS |
| FIELD ATTACHABLE C5 COUPLINGS |
| C14 COUPLINGS |
| GL COUPLINGS |
| GLX COUPLINGS |
| PCTS THERMOPLASTIC COUPLINGS |
| POLARSEAL COUPLINGS (ACA) |
| POLARSEAL II COUPLINGS (ACC) |
| POLARSEAL II COUPLINGS (ACB) |
| POWER STEERING |
| ADAPTERS |
| QUICK DISCONNECT COUPLERS |
| BALL VALVES |
| LIVE SWIVEL |
| ASSEMBLY FABRICATION |
| ACCESSORIES |
| EQUIPMENT AND PARTS |
| KITS |
| AIR BRAKE HOSE ASSY |
| BRASS |

Straight Female O-Ring with R134 Service Port H - Continued

| Part No. | Descr. | Prod. No. | | |
|--------------|-------------------|------------|-----|--------|
| | | | " | " |
| G46588-1008H | 10ACC-8FTON134SPH | 7332-50195 | 1/2 | 3/4-16 |

Straight Female O-Ring with R134 Service Port L

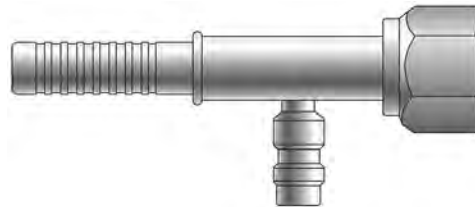

| Part No. | Descr. | Prod. No. | | |
|--------------|--------------------|------------|-----|-----------|
| | | | " | " |
| G46588-1010L | 10ACC-10FTON134SPL | 7332-50145 | 1/2 | 7/8-14 |
| G46588-1210L | 12ACC-10FTON134SPL | 7332-50205 | 5/8 | 7/8-14 |
| G46588-1212L | 12ACC-12FTON134SPL | 7332-50175 | 5/8 | 1 1/16-14 |
| G46588-1610L | 16ACC-10FTON134SPL | 7332-50155 | 7/8 | 7/8-14 |

Straight Female O-Ring with Switch Port M

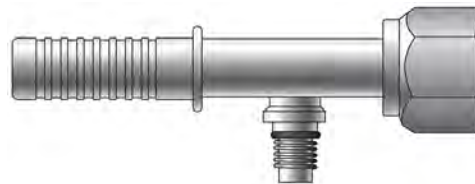

| Part No. | Descr. | Prod. No. | | |
|--------------|------------------|------------|-----|-----------|
| | | | " | " |
| G46588-1210M | 12ACC-10FTONMSWP | 7332-50215 | 5/8 | 7/8-14 |
| G46588-1212M | 12ACC-12FTONMSWP | 7332-50185 | 5/8 | 1 1/16-14 |



Straight Female O-Ring with Switch Port P

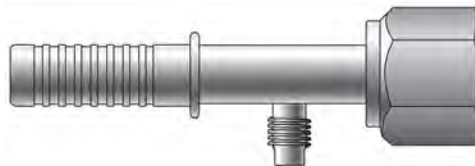

| Part No. | Descr. | Prod. No. | | |
|--------------|-----------------|------------|-------|-----------|
| | | | " | " |
| G46588-0808P | 8ACC-8FTONSWP | 7332-50125 | 13/32 | 3/4-16 |
| G46588-1212P | 12ACC-12FTONSWP | 7332-50165 | 5/8 | 1 1/16-14 |

Female O-Ring with R134 Service Port H - 90° Bent Tube

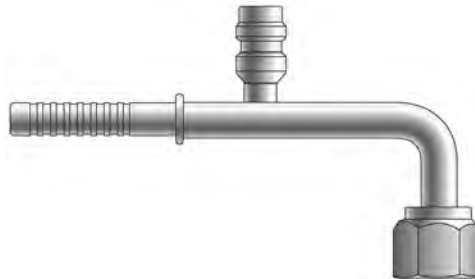

| Part No. | Descr. | Prod. No. | | |
|--------------|----------------------|------------|-------|--------|
| | | | " | " |
| G46589-0608H | 6ACC-8FTON134SPH90 | 7332-50505 | 5/16 | 3/4-16 |
| G46589-0808H | 8ACC-8FTON134SPH90 | 7332-50415 | 13/32 | 3/4-16 |
| G46589-1008H | 10ACC-8FTON134SPH90 | 7332-50485 | 1/2 | 3/4-16 |
| G46589-1010H | 10ACC-10FTON134SPH90 | 7332-50445 | 1/2 | 7/8-14 |

Female O-Ring with R134 Service Port L - 90° Bent Tube

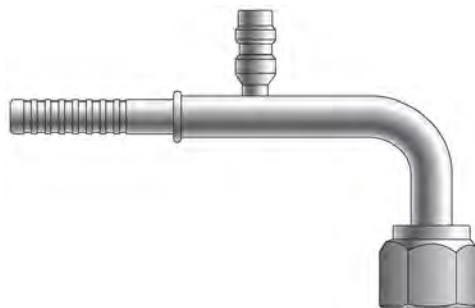

| Part No. | Descr. | Prod. No. | | |
|--------------|----------------------|------------|-----|--------|
| | | | " | " |
| G46589-1010L | 10ACC-10FTON134SPL90 | 7332-50425 | 1/2 | 7/8-14 |

| |
|------------------------------------|
| EQUIPMENT |
| HOSE/CPLG. SELECTION |
| G8K COUPLINGS |
| GLOBALSPIRAL COUPLINGS |
| STAINLESS STEEL SPIRAL |
| MEGACRIMP COUPLINGS |
| STAINLESS STEEL BRAID |
| POWER CRIMP COUPLINGS |
| FIELD ATTACHABLE G1 & G2 COUPLINGS |
| FIELD ATTACHABLE C5 COUPLINGS |
| C14 COUPLINGS |
| GL COUPLINGS |
| GLX COUPLINGS |
| PCTS THERMOPLASTIC COUPLINGS |
| POLARSEAL COUPLINGS (ACA) |
| POLARSEAL II COUPLINGS (ACC) |
| POLARSEAL II COUPLINGS (ACB) |
| POWER STEERING |
| ADAPTERS |
| QUICK DISCONNECT COUPLERS |
| BALL VALVES |
| LIVE SWIVEL |
| ASSEMBLY FABRICATION |
| ACCESSORIES |
| EQUIPMENT AND PARTS |
| KITS |
| AIR BRAKE HOSE ASSY |
| BRASS |



| |
|-------------------------------------|
| EQUIPMENT |
| HOSE/CPLG. SELECTION |
| G8K COUPLINGS |
| GLOBAL SPIRAL COUPLINGS |
| STAINLESS STEEL SPIRAL |
| MEGACRIMP COUPLINGS |
| STAINLESS STEEL BRAID |
| POWER CRIMP COUPLINGS |
| FIELD ATTACHABLE G1 & G2 COUPLINGS |
| FIELD ATTACHABLE C5 COUPLINGS |
| C14 COUPLINGS |
| GL COUPLINGS |
| GLX COUPLINGS |
| PCTS THERMOPLASTIC COUPLINGS |
| POLARSEAL COUPLINGS (ACA) |
| POLARSEAL II COUPLINGS (ACC) |
| POLARSEAL II COUPLINGS (ACB) |
| POWER STEERING |
| ADAPTERS |
| QUICK DISCONNECT COUPLERS |
| BALL VALVES |
| LIVE SWIVEL |
| ASSEMBLY FABRICATION |
| ACCESSORIES |
| EQUIPMENT AND PARTS |
| KITS |
| AIR BRAKE HOSE ASSY |
| BRASS |

Female O-Ring with R134 Service Port L - 90° Bent Tube - Continued

| Part No. | Descr. | Prod. No. | | |
|--------------|----------------------|------------|-----|--------|
| | | | " | " |
| G46589-1210L | 12ACC-10FTON134SPL90 | 7332-50515 | 5/8 | 7/8-14 |

Female O-Ring with Switch Port M - 90° Bent Tube

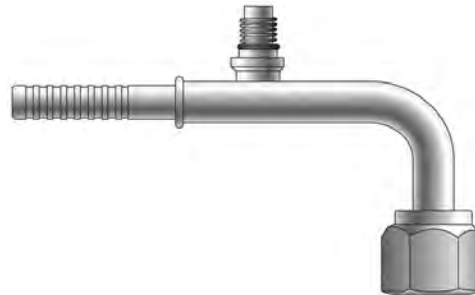

| Part No. | Descr. | Prod. No. | | |
|--------------|--------------------|------------|-----|-----------|
| | | | " | " |
| G46589-1010M | 10ACC-10FTONMSWP90 | 7332-50435 | 1/2 | 7/8-14 |
| G46589-1212M | 12ACC-12FTONMSWP90 | 7332-50465 | 5/8 | 1 1/16-14 |

Female O-Ring with Switch Port P - 90° Bent Tube

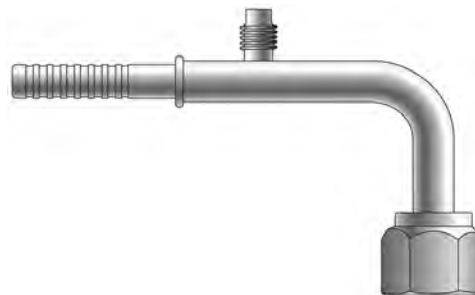

| Part No. | Descr. | Prod. No. | | |
|--------------|--------------------|------------|-------|-----------|
| | | | " | " |
| G46589-0808P | 8ACC-8FTONSWP90 | 7332-50405 | 13/32 | 3/4-16 |
| G46589-1008P | 10ACC-8FTONSWP90 | 7332-50475 | 1/2 | 3/4-16 |
| G46589-1210P | 12ACC-10FTONMSWP90 | 7332-50495 | 5/8 | 7/8-14 |
| G46589-1212P | 12ACC-12FTONMSWP90 | 7332-50455 | 5/8 | 1 1/16-14 |



Straight Female O-Ring

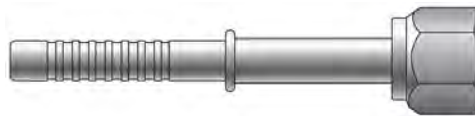

| Part No. | Descr. | Prod. No. | | |
|-------------|--------------|------------|-------|-----------|
| | | | " | " |
| G46590-0606 | 6ACC-6FTON | 7332-50015 | 5/16 | 5/8-18 |
| G46590-0608 | 6ACC-8FTON | 7332-50105 | 5/16 | 3/4-16 |
| G46590-0806 | 8ACC-6FTON | 7332-50075 | 13/32 | 5/8-18 |
| G46590-0808 | 8ACC-8FTON | 7332-50025 | 13/32 | 3/4-16 |
| G46590-0810 | 8ACC-10FTON | 7332-50115 | 13/32 | 7/8-14 |
| G46590-1008 | 10ACC-8FTON | 7332-50085 | 1/2 | 3/4-16 |
| G46590-1010 | 10ACC-10FTON | 7332-50035 | 1/2 | 7/8-14 |
| G46590-1210 | 12ACC-10FTON | 7332-50095 | 5/8 | 7/8-14 |
| G46590-1212 | 12ACC-12FTON | 7332-50055 | 5/8 | 1 1/16-14 |
| G46590-1610 | 16ACC-10FTON | 7332-50045 | 7/8 | 7/8-14 |
| G46590-1612 | 16ACC-12FTON | 7332-50065 | 7/8 | 1 1/16-14 |

Female O-Ring - 45° Bent Tube

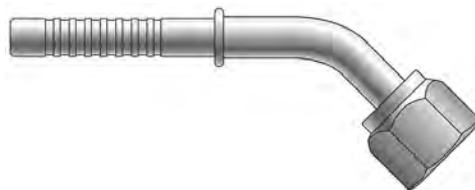

| Part No. | Descr. | Prod. No. | | |
|-------------|----------------|------------|-------|-----------|
| | | | " | " |
| G46591-0606 | 6ACC-6FTON45 | 7332-50225 | 5/16 | 5/8-18 |
| G46591-0808 | 8ACC-8FTON45 | 7332-50235 | 13/32 | 3/4-16 |
| G46591-1008 | 10ACC-8FTON45 | 7332-50275 | 1/2 | 3/4-16 |
| G46591-1010 | 10ACC-10FTON45 | 7332-50245 | 1/2 | 7/8-14 |
| G46591-1210 | 12ACC-10FTON45 | 7332-50285 | 5/8 | 7/8-14 |
| G46591-1212 | 12ACC-12FTON45 | 7332-50255 | 5/8 | 1 1/16-14 |
| G46591-1612 | 16ACC-12FTON45 | 7332-50265 | 7/8 | 1 1/16-14 |

- EQUIPMENT
- HOSE/CPLG. SELECTION
- G8K COUPLINGS
- GLOBALSPIRAL COUPLINGS
- STAINLESS STEEL SPIRAL
- MEGACRIMP COUPLINGS
- STAINLESS STEEL BRAID
- POWER CRIMP COUPLINGS
- FIELD ATTACHABLE G1 & G2 COUPLINGS
- FIELD ATTACHABLE C5 COUPLINGS
- C14 COUPLINGS
- GL COUPLINGS
- GLX COUPLINGS
- PCTS THERMOPLASTIC COUPLINGS
- POLARSEAL COUPLINGS (ACA)
- POLARSEAL II COUPLINGS (ACC)**
- POLARSEAL II COUPLINGS (ACB)
- POWER STEERING
- ADAPTERS
- QUICK DISCONNECT COUPLERS
- BALL VALVES
- LIVE SWIVEL
- ASSEMBLY FABRICATION
- ACCESSORIES
- EQUIPMENT AND PARTS
- KITS
- AIR BRAKE HOSE ASSY
- BRASS

| |
|-------------------------------------|
| EQUIPMENT |
| HOSE/CPLG. SELECTION |
| G8K COUPLINGS |
| GLOBAL SPIRAL COUPLINGS |
| STAINLESS STEEL SPIRAL |
| MEGACRIMP COUPLINGS |
| STAINLESS STEEL BRAID |
| POWER CRIMP COUPLINGS |
| FIELD ATTACHABLE G1 & G2 COUPLINGS |
| FIELD ATTACHABLE C5 COUPLINGS |
| C14 COUPLINGS |
| GL COUPLINGS |
| GLX COUPLINGS |
| PCTS THERMOPLASTIC COUPLINGS |
| POLARSEAL COUPLINGS (ACA) |
| POLARSEAL II COUPLINGS (ACC) |
| POLARSEAL II COUPLINGS (ACB) |
| POWER STEERING |
| ADAPTERS |
| QUICK DISCONNECT COUPLERS |
| BALL VALVES |
| LIVE SWIVEL |
| ASSEMBLY FABRICATION |
| ACCESSORIES |
| EQUIPMENT AND PARTS |
| KITS |
| AIR BRAKE HOSE ASSY |
| BRASS |

Female O-Ring - 90° Bent Tube

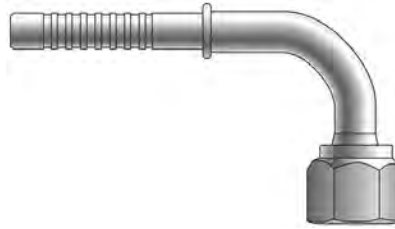

| Part No. | Descr. | Prod. No. | | |
|-------------|----------------|------------|-------|-----------|
| | | | " | " |
| G46592-0606 | 6ACC-6FTON90 | 7332-50295 | 5/16 | 5/8-18 |
| G46592-0608 | 6ACC-8FTON90 | 7332-50385 | 5/16 | 3/4-16 |
| G46592-0806 | 8ACC-6FTON90 | 7332-50355 | 13/32 | 5/8-18 |
| G46592-0808 | 8ACC-8FTON90 | 7332-50305 | 13/32 | 3/4-16 |
| G46592-0810 | 8ACC-10FTON90 | 7332-50395 | 13/32 | 7/8-14 |
| G46592-1008 | 10ACC-8FTON90 | 7332-50365 | 1/2 | 3/4-16 |
| G46592-1010 | 10ACC-10FTON90 | 7332-50315 | 1/2 | 7/8-14 |
| G46592-1210 | 12ACC-10FTON90 | 7332-50375 | 5/8 | 7/8-14 |
| G46592-1212 | 12ACC-12FTON90 | 7332-50335 | 5/8 | 1 1/16-14 |
| G46592-1610 | 16ACC-10FTON90 | 7332-50325 | 7/8 | 7/8-14 |
| G46592-1612 | 16ACC-12FTON90 | 7332-50345 | 7/8 | 1 1/16-14 |

Metric Female O-Ring

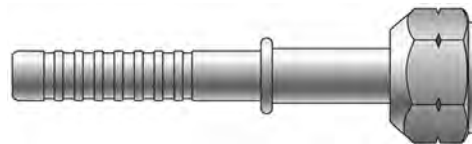

| Part No. | Descr. | Prod. No. | | |
|-------------|---------------|------------|-------|---------|
| | | | " | " |
| G46593-0820 | 8ACC-20FTOMN | 7332-51215 | 13/32 | M20X1.5 |
| G46593-1027 | 10ACC-27FTOMN | 7332-51225 | 1/2 | M27X2.0 |



Metric Female O-Ring - 90° Bent Tube

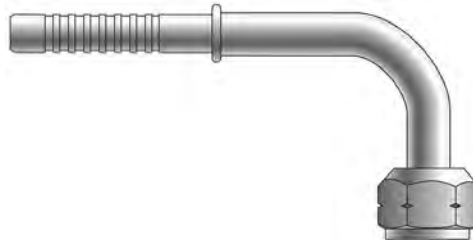

| Part No. | Descr. | Prod. No. | | |
|-------------|-----------------|------------|-------|---------|
| | | | " | " |
| G46595-0618 | 6ACC-18FTOMN90 | 7332-51235 | 5/16 | M18X1.5 |
| G46595-0820 | 8ACC-20FTOMN90 | 7332-51245 | 13/32 | M20X1.5 |
| G46595-1227 | 12ACC-27FTOMN90 | 7332-51255 | 5/8 | M27X2.0 |

Male Insert O-Ring

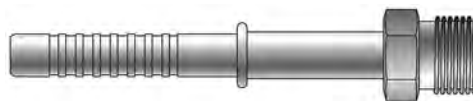

| Part No. | Descr. | Prod. No. | | |
|-------------|-------------|------------|-------|--------|
| | | | " | " |
| G46597-0606 | 6ACC-6MIO | 7332-50795 | 5/16 | 5/8-18 |
| G46597-0806 | 8ACC-6MIO | 7332-50815 | 13/32 | 5/8-18 |
| G46597-0808 | 8ACC-8MIO | 7332-50805 | 13/32 | 3/4-16 |
| G46597-1210 | 12ACC-10MIO | 7332-50825 | 5/8 | 7/8-14 |

Male Insert O-Ring - 90° Bent Tube

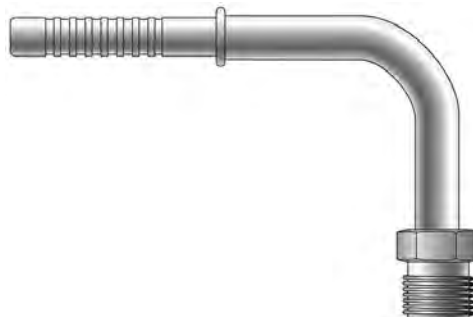

| Part No. | Descr. | Prod. No. | | |
|-------------|--------------|------------|-------|--------|
| | | | " | " |
| G46599-0606 | 6ACC-6MIO90 | 7332-50835 | 5/16 | 5/8-18 |
| G46599-0806 | 8ACC-6MIO90 | 7332-50865 | 13/32 | 5/8-18 |
| G46599-0808 | 8ACC-8MIO90 | 7332-50845 | 13/32 | 3/4-16 |
| G46599-1008 | 10ACC-8MIO90 | 7332-50875 | 1/2 | 3/4-16 |

| |
|-------------------------------------|
| EQUIPMENT |
| HOSE/CPLG. SELECTION |
| G8K COUPLINGS |
| GLOBALSPIRAL COUPLINGS |
| STAINLESS STEEL SPIRAL |
| MEGACRIMP COUPLINGS |
| STAINLESS STEEL BRAID |
| POWER CRIMP COUPLINGS |
| FIELD ATTACHABLE G1 & G2 COUPLINGS |
| FIELD ATTACHABLE C5 COUPLINGS |
| C14 COUPLINGS |
| GL COUPLINGS |
| GLX COUPLINGS |
| PCTS THERMOPLASTIC COUPLINGS |
| POLARSEAL COUPLINGS (ACA) |
| POLARSEAL II COUPLINGS (ACC) |
| POLARSEAL II COUPLINGS (ACB) |
| POWER STEERING |
| ADAPTERS |
| QUICK DISCONNECT COUPLERS |
| BALL VALVES |
| LIVE SWIVEL |
| ASSEMBLY FABRICATION |
| ACCESSORIES |
| EQUIPMENT AND PARTS |
| KITS |
| AIR BRAKE HOSE ASSY |
| BRASS |



| |
|-------------------------------------|
| EQUIPMENT |
| HOSE/CPLG. SELECTION |
| G8K COUPLINGS |
| GLOBAL SPIRAL COUPLINGS |
| STAINLESS STEEL SPIRAL |
| MEGACRIMP COUPLINGS |
| STAINLESS STEEL BRAID |
| POWER CRIMP COUPLINGS |
| FIELD ATTACHABLE G1 & G2 COUPLINGS |
| FIELD ATTACHABLE C5 COUPLINGS |
| C14 COUPLINGS |
| GL COUPLINGS |
| GLX COUPLINGS |
| PCTS THERMOPLASTIC COUPLINGS |
| POLARSEAL COUPLINGS (ACA) |
| POLARSEAL II COUPLINGS (ACC) |
| POLARSEAL II COUPLINGS (ACB) |
| POWER STEERING |
| ADAPTERS |
| QUICK DISCONNECT COUPLERS |
| BALL VALVES |
| LIVE SWIVEL |
| ASSEMBLY FABRICATION |
| ACCESSORIES |
| EQUIPMENT AND PARTS |
| KITS |
| AIR BRAKE HOSE ASSY |
| BRASS |

Male Insert O-Ring - 90° Bent Tube - Continued

| Part No. | Descr. | Prod. No. | | |
|-------------|---------------|------------|-----|--------|
| | | | " | " |
| G46599-1010 | 10ACC-10MIO90 | 7332-50855 | 1/2 | 7/8-14 |
| G46599-1210 | 12ACC-10MIO90 | 7332-50885 | 5/8 | 7/8-14 |

Male Insert O-Ring Bulkhead

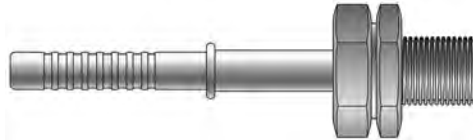

| Part No. | Descr. | Prod. No. | | |
|-------------|-----------------|------------|-------|-----------|
| | | | " | " |
| G46600-0606 | 6ACC-6MIOBKHD | 7332-50705 | 5/16 | 5/8-18 |
| G46600-0808 | 8ACC-8MIOBKHD | 7332-50715 | 13/32 | 3/4-16 |
| G46600-1010 | 10ACC-10MIOBKHD | 7332-50725 | 1/2 | 7/8-14 |
| G46600-1210 | 12ACC-10MIOBKHD | 7332-50745 | 5/8 | 7/8-14 |
| G46600-1612 | 16ACC-12MIOBKHD | 7332-50735 | 7/8 | 1 1/16-14 |

Male Insert O-Ring Bulkhead - 90° Bent Tube

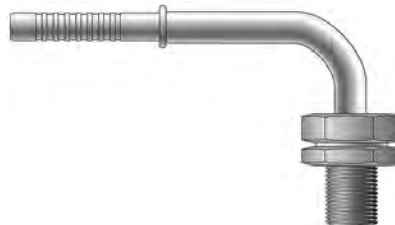

| Part No. | Descr. | Prod. No. | | |
|-------------|-------------------|------------|-------|--------|
| | | | " | " |
| G46602-0606 | 6ACC-6MIOBKHD90 | 7332-50755 | 5/16 | 5/8-18 |
| G46602-0808 | 8ACC-8MIOBKHD90 | 7332-50765 | 13/32 | 3/4-16 |
| G46602-1010 | 10ACC-10MIOBKHD90 | 7332-50775 | 1/2 | 7/8-14 |
| G46602-1210 | 12ACC-10MIOBKHD90 | 7332-50785 | 5/8 | 7/8-14 |



Splicer with R134 Service Port H

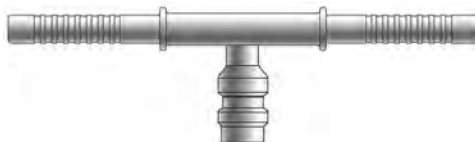

| Part No. | Descr. | Prod. No. | | |
|--------------|-------------------|------------|-------|----|
| | | | " | " |
| G46956-0606H | 6ACC-6HLE134SPH | 7332-50965 | 5/16 | 6 |
| G46956-0808H | 8ACC-8HLE134SPH | 7332-50985 | 13/32 | 8 |
| G46956-1010H | 10ACC-10HLE134SPH | 7332-51035 | 1/2 | 10 |

Splicer with R134 Service Port L

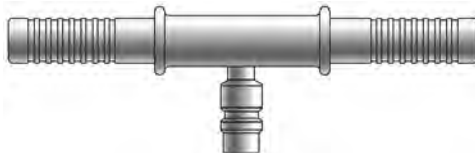

| Part No. | Descr. | Prod. No. | | |
|--------------|-------------------|------------|-----|----|
| | | | " | " |
| G46956-1010L | 10ACC-10HLE134SPL | 7332-51015 | 1/2 | 10 |
| G46956-1212L | 12ACC-12HLE134SPL | 7332-51055 | 5/8 | 12 |
| G46956-1616L | 16ACC-16HLE134SPL | 7332-51075 | 7/8 | 16 |

Splicer with Switch Port M



| Part No. | Descr. | Prod. No. | | |
|--------------|-----------------|------------|-------|----|
| | | | " | " |
| G46956-0808M | 8ACC-8HLEMSWP | 7332-50995 | 13/32 | 8 |
| G46956-1010M | 10ACC-10HLEMSWP | 7332-51025 | 1/2 | 10 |
| G46956-1212M | 12ACC-12HLEMSWP | 7332-51065 | 5/8 | 12 |

| |
|-------------------------------------|
| EQUIPMENT |
| HOSE/CPLG. SELECTION |
| G8K COUPLINGS |
| GLOBALSPIRAL COUPLINGS |
| STAINLESS STEEL SPIRAL |
| MEGACRIMP COUPLINGS |
| STAINLESS STEEL BRAID |
| POWER CRIMP COUPLINGS |
| FIELD ATTACHABLE G1 & G2 COUPLINGS |
| FIELD ATTACHABLE C5 COUPLINGS |
| C14 COUPLINGS |
| GL COUPLINGS |
| GLX COUPLINGS |
| PCTS THERMOPLASTIC COUPLINGS |
| POLARSEAL COUPLINGS (ACA) |
| POLARSEAL II COUPLINGS (ACC) |
| POLARSEAL II COUPLINGS (ACB) |
| POWER STEERING |
| ADAPTERS |
| QUICK DISCONNECT COUPLERS |
| BALL VALVES |
| LIVE SWIVEL |
| ASSEMBLY FABRICATION |
| ACCESSORIES |
| EQUIPMENT AND PARTS |
| KITS |
| AIR BRAKE HOSE ASSY |
| BRASS |

| |
|-------------------------------------|
| EQUIPMENT |
| HOSE/CPLG. SELECTION |
| G8K COUPLINGS |
| GLOBAL SPIRAL COUPLINGS |
| STAINLESS STEEL SPIRAL |
| MEGACRIMP COUPLINGS |
| STAINLESS STEEL BRAID |
| POWER CRIMP COUPLINGS |
| FIELD ATTACHABLE G1 & G2 COUPLINGS |
| FIELD ATTACHABLE C5 COUPLINGS |
| C14 COUPLINGS |
| GL COUPLINGS |
| GLX COUPLINGS |
| PCTS THERMOPLASTIC COUPLINGS |
| POLARSEAL COUPLINGS (ACA) |
| POLARSEAL II COUPLINGS (ACC) |
| POLARSEAL II COUPLINGS (ACB) |
| POWER STEERING |
| ADAPTERS |
| QUICK DISCONNECT COUPLERS |
| BALL VALVES |
| LIVE SWIVEL |
| ASSEMBLY FABRICATION |
| ACCESSORIES |
| EQUIPMENT AND PARTS |
| KITS |
| AIR BRAKE HOSE ASSY |
| BRASS |

Splicer with Switch Port P



| Part No. | Descr. | Prod. No. | | |
|--------------|----------------|------------|-------|----|
| | | | " | " |
| G46956-0606P | 6ACC-6HLESWP | 7332-50955 | 5/16 | 6 |
| G46956-0808P | 8ACC-8HLESWP | 7332-50975 | 13/32 | 8 |
| G46956-1010P | 10ACC-10HLESWP | 7332-51005 | 1/2 | 10 |
| G46956-1212P | 12ACC-12HLESWP | 7332-51045 | 5/8 | 12 |

Metric Female O-Ring with Switch or Service Port - 90° Bent Tube

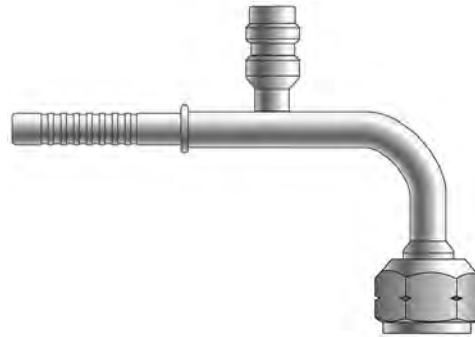

| Part No. | Descr. | Prod. No. | | |
|-------------|----------------------|------------|------|---------|
| | | | " | " |
| G46963-0610 | 6ACC-10FTOMN90134SPH | 7332-51265 | 5/16 | M10X1.5 |

Metric Male Insert O-Ring

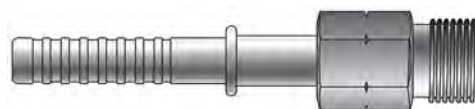

| Part No. | Descr. | Prod. No. | | |
|-------------|--------------|------------|-----|---------|
| | | | " | " |
| G46965-1020 | 10ACC-20MIOM | 7332-51285 | 1/2 | M20X1.5 |



Clamp Assemblies



| Part No. | Descr. | Prod. No. | |
|-------------|---------|------------|-------|
| | | | " |
| G46995-0006 | 6CLAMP | 7332-51295 | 5/16 |
| G46995-0008 | 8CLAMP | 7332-51305 | 13/32 |
| G46995-0010 | 10CLAMP | 7332-51315 | 1/2 |
| G46995-0012 | 12CLAMP | 7332-51325 | 5/8 |
| G46995-0016 | 16CLAMP | 7332-51335 | 7/8 |

- EQUIPMENT
- HOSE/CPLG. SELECTION
- G8K COUPLINGS
- GLOBALSPIRAL COUPLINGS
- STAINLESS STEEL SPIRAL
- MEGACRIMP COUPLINGS
- STAINLESS STEEL BRAID
- POWER CRIMP COUPLINGS
- FIELD ATTACHABLE G1 & G2 COUPLINGS
- FIELD ATTACHABLE C5 COUPLINGS
- C14 COUPLINGS
- GL COUPLINGS
- GLX COUPLINGS
- PCTS THERMOPLASTIC COUPLINGS
- POLARSEAL COUPLINGS (ACA)
- POLARSEAL II COUPLINGS (ACC)**
- POLARSEAL II COUPLINGS (ACB)
- POWER STEERING
- ADAPTERS
- QUICK DISCONNECT COUPLERS
- BALL VALVES
- LIVE SWIVEL
- ASSEMBLY FABRICATION
- ACCESSORIES
- EQUIPMENT AND PARTS
- KITS
- AIR BRAKE HOSE ASSY
- BRASS