

LIST NUMBER INDEX



MAGNUM Solid Carbide Burs

Proudly made in the U.S.A.

• PREMIUM CARBIDE SUBSTRATE

For use in a wide range of materials including Steel, Stainless Steel, Aluminum, Magnesium, Cast Iron, Brass, Copper, and Plastic.

• MADE IN THE U.S.A.

Our burs are manufactured at our own state-of-the-art manufacturing facility, located in Baton Rouge, LA. Our manufacturing processes are modern, utilizing the newest technologies and CNC machinery available today.

• COMPLETE LINE OF BURS

Single Cut, Double Cut, Long Series, Miniature, and Non-Ferrous Cut in all the different shapes.

• SERVICE AND RELIABILITY

Backed by our strong 97% delivery security and the service you have come to expect from Drillco.



DRILLCO CUTTING TOOLS



Burs

7's		7000GX		8's		Sets	
LIST NUMBER	PAGE #			LIST NUMBER	PAGE #	LIST NUMBER	PAGE #
7000A	168	7000H	171	8000	178	DISPLAY- BURS	177
7000AAL	175	7000HX	171	8100	178	SETS - BURS	176
7000AX	168	7000J	172	8300	178		
7000B	168	7000K	172	8400	178		
7000C	169	7000L	173				
7000CAL	175	7000LAL	175				
7000CX	169	7000LX	173				
7000D	169	7000M	173				
7000DAL	175	7000N	174				
7000DX	169	7000NE	174				
7000E	170						
7000EAL	175						
7000EX	170						
7000F	170						
7000FAL	175						
7000FX	170						
7000G	171						

SOLID CARBIDE Magnum



PACKAGING:
All sizes are individually packaged.

Carbide burs are one of the most widely used and versatile cutting tools, used in virtually every industry. Manufactured from Tungsten Carbide, they are primarily used to remove burrs (the small flakes of metal) that often remain on the workpiece after the machining process. Burs are available in standard lengths, long series (for hard to reach applications), and in miniature sizes (for use in pencil grinders).

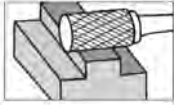

SA Bur Profile

7000A/7000AX 7000B

DEBURRING
INTERIOR CONTOUR WORK

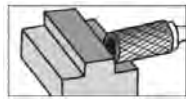

SB Bur Profile

Tool No.	Cutter Dia.	Shank Dia.	Length of Cut	Single Cut EDP No.	Double Cut EDP No.
SERIES 7000A			CYLINDRICAL		
SA-11	1/8"	1/4"	1/2"	7A108BSC	7A108BDC
SA-12	1/8"	1/4"	5/8"	7A108ASC	7A108ADC
SA-14	3/16"	1/4"	5/8"	7A112ASC	7A112ADC
SA-1	1/4"	1/4"	5/8"	7A116ASC	7A116ADC
SA-1L	1/4"	1/4"	1"	7A116BSC	7A116BDC
SA-2	5/16"	1/4"	3/4"	7A120ASC	7A120ADC
SA-2L	5/16"	1/4"	1"	7A120BSC	7A120BDC
SA-3	3/8"	1/4"	3/4"	7A124ASC	7A124ADC
SA-3L	3/8"	1/4"	1"	7A124BSC	7A124BDC
SA-3XL	3/8"	1/4"	1-1/2"	7A124CSC	7A124CDC
SA-4	7/16"	1/4"	1"	7A128BSC	7A128BDC
SA-5	1/2"	1/4"	1"	7A132BSC	7A132BDC
SA-6	5/8"	1/4"	1"	7A140BSC	7A140BDC
SA-16	3/4"	1/4"	3/4"	7A148ASC	7A148ADC
SA-7	3/4"	1/4"	1"	7A148BSC	7A148BDC
SA-9	1"	1/4"	1"	7A164BSC	7A164BDC
SERIES 7000A			MINIATURE		
SA-41	1/16"	1/8"	1/4"	70A041SC	70A041DC
SA-42	3/32"	1/8"	7/16"	70A042SC	70A042DC
SA-43	1/8"	1/8"	9/16"	70A043SC	70A043DC
SA-51	1/4"	1/8"	1/2"	70A051SC	70A051DC
SA-52	5/32"	1/8"	1/2"	70A052SC	70A052DC
SA-53	3/16"	1/8"	1/2"	70A053SC	70A053DC
SA-61	1/16"	3/32"	1/4"	70A061SC	70A061DC
SA-63	3/32"	3/32"	3/8"	70A063SC	70A063DC
SA-81	3/16"	3/16"	1/2"	70A081SC	70A081DC
SA-43L2	1/8"	1/8"	9/16"	7A43L2SC	7A43L2DC
SA-43L3	1/8"	1/8"	9/16"	7A43L3SC	7A43L3DC
SERIES 7000AX			6" EXTRA LONG		
SA-1L6	1/4"	1/4"	1/2"	7AX116SC	7AX116DC
SA-3L6	3/8"	1/4"	3/4"	7AX124SC	7AX124DC
SA-5L6	1/2"	1/4"	1"	7AX132SC	7AX132DC

Tool No.	Cutter Dia.	Shank Dia.	Length of Cut	Single Cut EDP No.	Double Cut EDP No.
SERIES 7000B			CYLINDRICAL WITH END CUT		
SB-12	1/8"	1/4"	5/8"	7B108ASC	7B108ADC
SB-11	1/8"	1/4"	1/2"	7B108BSC	7B108BDC
SB-14	3/16"	1/4"	5/8"	7B112ASC	7B112ADC
SB-1	1/4"	1/4"	5/8"	7B116ASC	7B116ADC
SB-1L	1/4"	1/4"	1"	7B116BSC	7B116BDC
SB-2	5/16"	1/4"	3/4"	7B120ASC	7B120ADC
SB-2L	5/16"	1/4"	1"	7B120BSC	7B120BDC
SB-3	3/8"	1/4"	3/4"	7B124ASC	7B124ADC
SB-3L	3/8"	1/4"	1"	7B124BSC	7B124BDC
SB-3XL	3/8"	1/4"	1-1/2"	7B124CSC	7B124CDC
SB-4	7/16"	1/4"	1"	7B128BSC	7B128BDC
SB-5	1/2"	1/4"	1"	7B132BSC	7B132BDC
SB-6	5/8"	1/4"	1"	7B140BSC	7B140BDC
SB-16	3/4"	1/4"	3/4"	7B148ASC	7B148ADC
SB-7	3/4"	1/4"	1"	7B148BSC	7B148BDC
SB-9	1"	1/4"	1"	7B164BSC	7B164BDC
SERIES 7000B			MINIATURE		
SB-43	1/8"	1/8"	9/16"	70B043SC	70B043DC
SB-51	1/4"	1/8"	3/16"	70B051SC	70B051DC
SB-ECO	1/8"	1/8"	-	70BECOSC	70BECODC

Burs

SOLID CARBIDE Magnum



PACKAGING:
All sizes are individually packaged.

7000C/7000CX 7000D/7000DX

SURFACE MILLING & CONTOUR WORK
SURFACE MILLING, DEBURRING & CONTOUR WORK

Description and applications as 7000A.

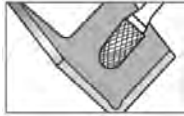

SC Bur Profile

Tool No.	Cutter Dia.	Shank Dia.	Length of Cut	Single Cut EDP No.	Double Cut EDP No.
SERIES 7000C CYLINDRICAL BALL NOSE					
SC-11	1/8"	1/4"	1/2"	7C108BSC	7C108BDC
SC-12	1/8"	1/4"	5/8"	7C108ASC	7C108ADC
SC-14	3/16"	1/4"	5/8"	7C112ASC	7C112ADC
SC-1	1/4"	1/4"	5/8"	7C116ASC	7C116ADC
SC-1L	1/4"	1/4"	1"	7C116BSC	7C116BDC
SC-2	5/16"	1/4"	3/4"	7C120ASC	7C120ADC
SC-2L	5/16"	1/4"	1"	7C120BSC	7C120BDC
SC-3	3/8"	1/4"	3/4"	7C124ASC	7C124ADC
SC-3L	3/8"	1/4"	1"	7C124BSC	7C124BDC
SC-3XL	3/8"	1/4"	1-1/2"	7C124CSC	7C124CDC
SC-4	7/16"	1/4"	1"	7C128BSC	7C128BDC
SC-5	1/2"	1/4"	1"	7C132BSC	7C132BDC
SC-6	5/8"	1/4"	1"	7C140BSC	7C140BDC
SC-7	3/4"	1/4"	1"	7C148BSC	7C148BDC
SC-9	1"	1/4"	1"	7C164BSC	7C164BDC
SERIES 7000C MINIATURE					
SC-41	3/32"	1/8"	7/16"	70C041SC	70C041DC
SC-42	1/8"	1/8"	9/16"	70C042SC	70C042DC
SC-51	1/4"	1/8"	1/2"	70C051SC	70C051DC
SC-52	5/32"	1/8"	1/2"	70C052SC	70C052DC
SC-53	3/16"	1/8"	1/2"	70C053SC	70C053DC
SC-61	3/32"	3/32"	3/8"	70C061SC	70C061DC
SC-81	3/16"	3/16"	1/2"	70C081SC	70C081DC
SC-42L2	1/8"	1/8"	9/16"	7C42L2SC	7C42L2DC
SC-42L3	1/8"	1/8"	9/16"	7C42L3SC	7C42L3DC
SERIES 7000CX 6" EXTRA LONG					
SC-1L6	1/4"	1/4"	1/2"	7CX116SC	7CX116DC
SC-3L6	3/8"	1/4"	3/4"	7CX124SC	7CX124DC
SC-5L6	1/2"	1/4"	1"	7CX132SC	7CX132DC

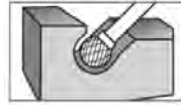

SD Bur Profile

Tool No.	Cutter Dia.	Shank Dia.	Length of Cut	Single Cut EDP No.	Double Cut EDP No.
SERIES 7000D BALL SHAPE					
SD-12	1/8"	1/4"	1/8"	7D108ASC	7D108ADC
SD-14	3/16"	1/4"	3/16"	7D112ASC	7D112ADC
SD-1	1/4"	1/4"	1/4"	7D116ASC	7D116ADC
SD-2	5/16"	1/4"	5/16"	7D120ASC	7D120ADC
SD-3	3/8"	1/4"	3/8"	7D124ASC	7D124ADC
SD-4	7/16"	1/4"	7/16"	7D128ASC	7D128ADC
SD-5	1/2"	1/4"	1/2"	7D132ASC	7D132ADC
SD-6	5/8"	1/4"	5/8"	7D140ASC	7D140ADC
SD-7	3/4"	1/4"	3/4"	7D148ASC	7D148ADC
SD-9	1"	1/4"	1"	7D164ASC	7D164ADC
SERIES 7000D MINIATURE					
SD-41	3/32"	1/8"	3/32"	70D041SC	70D041DC
SD-42	1/8"	1/8"	1/8"	70D042SC	70D042DC
SD-51	1/4"	1/8"	7/32"	70D051SC	70D051DC
SD-53	3/16"	1/8"	5/32"	70D053SC	70D053DC
SD-61	3/32"	3/32"	3/32"	70D061SC	70D061DC
SD-81	3/16"	3/16"	5/32"	7D42L2SC	7D081DC
SD-42L2	1/8"	1/8"	1/8"	7D42L3SC	7D42L2DC
SERIES 7000DX 6" EXTRA LONG					
SD-1L6	1/4"	1/4"	7/32"	7DX116SC	7DX116DC
SD-3L6	3/8"	1/4"	5/16"	7DX124SC	7DX124DC
SD-5L6	1/2"	1/4"	7/16"	7DX132SC	7DX132DC

Burs

SOLID CARBIDE Magnum



PACKAGING:
All sizes are individually packaged.

7000E/7000EX 7000F/7000FX

CONTOUR WORK
NARROW CONTOUR WORK

Carbide burs are one of the most widely used and versatile cutting tools, used in virtually every industry. Manufactured from Tungsten Carbide, they are primarily used to remove burrs (the small flakes of metal) that often remain on the workpiece after the machining process. Burs are available in standard lengths, long series (for hard to reach applications), and in miniature sizes (for use in pencil grinders).

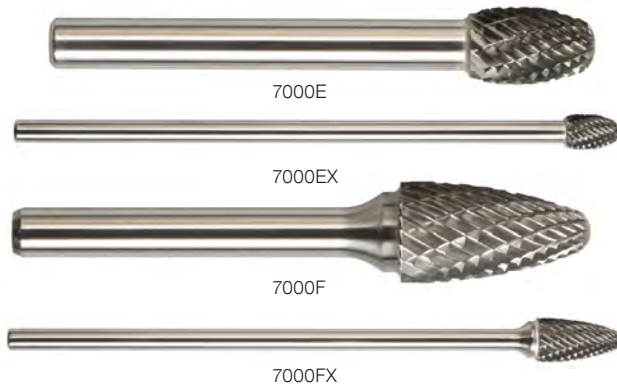

SE Bur Profile

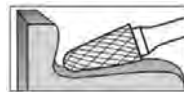

SF Bur Profile

Tool No.	Cutter Dia.	Shank Dia.	Length of Cut	Single Cut EDP No.	Double Cut EDP No.
SERIES 7000E OVAL SHAPE					
SE-11	3/16"	1/4"	5/16"	7E112ASC	7E112ADC
SE-1	1/4"	1/4"	3/8"	7E116ASC	7E116ADC
SE-2	5/16"	1/4"	5/8"	7E120ASC	7E120ADC
SE-3	3/8"	1/4"	5/8"	7E124ASC	7E124ADC
SE-5	1/2"	1/4"	7/8"	7E132ASC	7E132ADC
SE-6	5/8"	1/4"	1"	7E140ASC	7E140ADC
SE-7	3/4"	1/4"	1"	7E148ASC	7E148ADC
SERIES 7000E MINIATURE					
SE-41	1/8"	1/8"	7/32"	70E041SC	70E041DC
SE-51	1/4"	1/8"	3/8"	70E051SC	70E051DC
SE-53	3/16"	1/8"	9/32"	70E053SC	70E053DC
SE-61	3/32"	3/32"	1/8"	70E061SC	70E061DC
SE-81	3/16"	3/16"	9/32"	70E081SC	70E081DC
SE-41L2	1/8"	1/8"	7/32"	7E41L2SC	7E41L2DC
SE-41L3	1/8"	1/8"	7/32"	7E41L3SC	7E41L3DC
SERIES 7000EX 6" EXTRA LONG					
SE-1L6	1/4"	1/4"	3/8"	7EX116SC	7EX116DC
SE-3L6	3/8"	1/4"	5/8"	7EX124SC	7EX124DC
SE-5L6	1/2"	1/4"	7/8"	7EX132SC	7EX132DC

Tool No.	Cutter Dia.	Shank Dia.	Length of Cut	Single Cut EDP No.	Double Cut EDP No.
SERIES 7000F ROUND TREE SHAPE					
SF-11	1/8"	1/4"	5/8"	7F108BSC	7F108BDC
SF-12	1/8"	1/4"	1/2"	7F108ASC	7F108ADC
SF-1	1/4"	1/4"	5/8"	7F116ASC	7F116ADC
SF-1L	1/4"	1/4"	3/4"	7F116BSC	7F116BDC
SF-3	3/8"	1/4"	3/4"	7F124ASC	7F124ADC
SF-4	7/16"	1/4"	1"	7F128ASC	7F128ADC
SF-13	1/2"	1/4"	3/4"	7F132ASC	7F132ADC
SF-5	1/2"	1/4"	1"	7F132BSC	7F132BDC
SF-6	5/8"	1/4"	1"	7F140ASC	7F140ADC
SF-7	3/4"	1/4"	1"	7F148ASC	7F148ADC
SF-14	3/4"	1/4"	1-1/4"	7F148BSC	7F148BDC
SF-15	3/4"	1/4"	1-1/2"	7F148CSC	7F148CDC
SERIES 7000F MINIATURE					
SF-41	1/8"	1/8"	1/4"	70F041SC	70F041DC
SF-42	1/8"	1/8"	1/2"	70F042SC	70F042DC
SF-51	1/4"	1/8"	1/2"	70F051SC	70F051DC
SF-53	3/16"	1/8"	1/2"	70F053SC	70F053DC
SF-61	3/32"	3/32"	1/4"	70F061SC	70F061DC
SF-81	3/16"	3/16"	1/2"	70F081SC	70F081DC
SF-42L2	1/8"	1/8"	1/2"	7F42L2SC	7F42L2DC
SF-42L3	1/8"	1/8"	1/2"	7F42L3SC	7F42L3DC
SERIES 7000FX 6" EXTRA LONG					
SF-1L6	1/4"	1/4"	1/2"	7FX116SC	7FX116DC
SF-3L6	3/8"	1/4"	3/4"	7FX124SC	7FX124DC
SF-5L6	1/2"	1/4"	1"	7FX132SC	7FX132DC

Burs

SOLID CARBIDE Magnum



PACKAGING:
All sizes are individually packaged.

7000G/7000GX 7000H/7000HX

SURFACE MILLING & NARROW CONTOUR WORK
CONTOUR WORK

Carbide burs are one of the most widely used and versatile cutting tools, used in virtually every industry. Manufactured from Tungsten Carbide, they are primarily used to remove burrs (the small flakes of metal) that often remain on the workpiece after the machining process. Burs are available in standard lengths, long series (for hard to reach applications), and in miniature sizes (for use in pencil grinders).

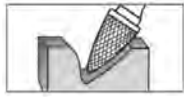

SG Bur Profile

Tool No.	Cutter Dia.	Shank Dia.	Length of Cut	Single Cut EDP No.	Double Cut EDP No.
SERIES 7000G			POINTED TREE SHAPE		
SG-1	1/4"	1/4"	5/8"	7G116ASC	7G116ADC
SG-1L	1/4"	1/4"	3/4"	7G116BSC	7G116BDC
SG-2	5/16"	1/4"	3/4"	7G120ASC	7G120ADC
SG-3	3/8"	1/4"	3/4"	7G124ASC	7G124ADC
SG-13	1/2"	1/4"	3/4"	7G132ASC	7G132ADC
SG-5	1/2"	1/4"	1"	7G132BSC	7G132BDC
SG-6	5/8"	1/4"	1"	7G140ASC	7G140ADC
SG-7	3/4"	1/4"	1"	7G148ASC	7G148ADC
SG-15	3/4"	1/4"	1-1/2"	7G148BSC	7G148BDC
SERIES 7000G			MINIATURE		
SG-41	1/8"	1/8"	1/4"	70G041SC	70G041DC
SG-42	1/8"	1/8"	5/16"	70G042SC	70G042DC
SG-43	1/8"	1/8"	3/8"	70G043SC	70G043DC
SG-44	1/8"	1/8"	1/2"	70G044SC	70G044DC
SG-51	1/4"	1/8"	1/2"	70G051SC	70G051DC
SG-53	3/16"	1/8"	1/2"	70G053SC	70G053DC
SG-61	3/32"	3/32"	1/4"	70G061SC	70G061DC
SG-81	3/16"	3/16"	1/2"	70G081SC	70G081DC
SG-44L2	1/8"	1/8"	1/2"	7G44L2SC	7G44L2DC
SG-44L3	1/8"	1/8"	1/2"	7G44L3SC	7G44L3DC
SERIES 7000GX			6" EXTRA LONG		
SG-1L6	1/4"	1/4"	1/2"	7GX116SC	7GX116DC
SG-3L6	3/8"	1/4"	3/4"	7GX124SC	7GX124DC
SG-5L6	1/2"	1/4"	1"	7GX132SC	7GX132DC

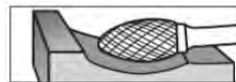

SH Bur Profile

Tool No.	Cutter Dia.	Shank Dia.	Length of Cut	Single Cut EDP No.	Double Cut EDP No.
SERIES 7000H			FLAME SHAPE		
SH-1	1/4"	1/4"	1/2"	7H116ASC	7H116ADC
SH-2	5/16"	1/4"	3/4"	7H120ASC	7H120ADC
SH-5	1/2"	1/4"	1-1/4"	7H132ASC	7H132ADC
SH-6	5/8"	1/4"	1-7/16"	7H140ASC	7H140ADC
SH-7	3/4"	1/4"	1-5/8"	7H148ASC	7H148ADC
SERIES 7000H			MINIATURE		
SH-41	1/8"	1/8"	1/4"	70H041SC	70H041DC
SH-53	3/16"	1/8"	3/8"	70H053SC	70H053DC
SH-41L2	1/8"	1/8"	1/4"	7H41L2SC	7H41L2DC
SH-41L3	1/8"	1/8"	1/4"	7H41L3SC	7H41L3DC
SERIES 7000HX			6" EXTRA LONG		
SH-2L6	5/16"	1/4"	3/4"	7HX120SC	7HX120DC
SH-5L6	1/2"	1/4"	1-1/4"	7HX132SC	7HX132DC

Burs

SOLID CARBIDE Magnum



PACKAGING:
All sizes are individually packaged.

7000J

MACHINING OF ACUTE ANGLE AREAS & COUNTERSINKING

Carbide burs are one of the most widely used and versatile cutting tools, used in virtually every industry. Manufactured from Tungsten Carbide, they are primarily used to remove burrs (the small flakes of metal) that often remain on the workpiece after the machining process. Burs are available in standard lengths, long series (for hard to reach applications), and in miniature sizes (for use in pencil grinders).

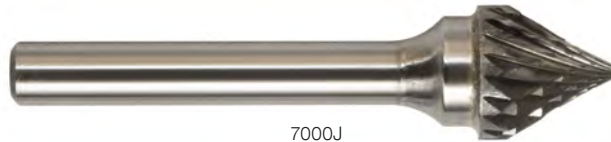

7000J

SJ Bur Profile

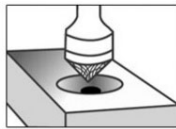

Tool No.	Cutter Dia.	Shank Dia.	Length of Cut	Single Cut EDP No.	Double Cut EDP No.
SERIES 7000J			60° INCLUDED ANGLE		
SJ-1	3/16"	1/4"	3/16"	7J116ASC	7J116ADC
SJ-2	1/4"	1/4"	1/4"	7J120ASC	7J120ADC
SJ-3	5/16"	1/4"	1/4"	7J124ASC	7J124ADC
SJ-5	3/8"	1/4"	7/16"	7J132ASC	7J132ADC
SJ-6	1/2"	1/4"	1/2"	7J140ASC	7J140ADC
SJ-7	5/8"	1/4"	5/8"	7J148ASC	7J148ADC
SJ-9	3/4"	1/4"	3/4"	7J164ASC	7J164ADC
SERIES 7000J			MINIATURE		
SJ-42	1/8"	1/8"	3/32"	70J042SC	70J042DC

7000K

MACHINING OF ACUTE ANGLE AREAS & COUNTERSINKING

Description and applications as 7000J.

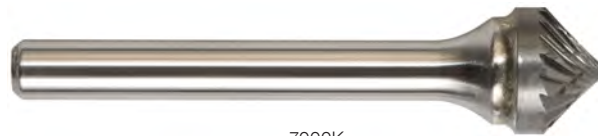

7000K

SK Bur Profile

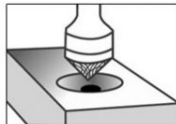

Tool No.	Cutter Dia.	Shank Dia.	Length of Cut	Single Cut EDP No.	Double Cut EDP No.
SERIES 7000K			90° INCLUDED ANGLE		
SK-1	1/4"	1/4"	1/8"	7K116ASC	7K116ADC
SK-2	5/16"	1/4"	3/16"	7K120ASC	7K120ADC
SK-3	3/8"	1/4"	3/16"	7K124ASC	7K124ADC
SK-5	1/2"	1/4"	1/4"	7K132ASC	7K132ADC
SK-6	5/8"	1/4"	5/16"	7K140ASC	7K140ADC
SK-7	3/4"	1/4"	3/8"	7K148ASC	7K148ADC
SK-9	1"	1/4"	1/2"	7K164ASC	7K164ADC
SERIES 7000K			MINIATURE		
SK-42	1/8"	1/8"	7/32"	70K042SC	70K042DC

Burs

SOLID CARBIDE Magnum



PACKAGING:
All sizes are individually packaged.

7000L/7000LX 7000M

SURFACE MACHINING & NARROW CONTOUR WORK
SURFACE MACHINING & NARROW CONTOUR WORK

Carbide burs are one of the most widely used and versatile cutting tools, used in virtually every industry. Manufactured from Tungsten Carbide, they are primarily used to remove burrs (the small flakes of metal) that often remain on the workpiece after the machining process. Burs are available in standard lengths, long series (for hard to reach applications), and in miniature sizes (for use in pencil grinders).



SL Bur Profile



SM Bur Profile



Tool No.	Cutter Dia.	Shank Dia.	Length of Cut	Single Cut EDP No.	Double Cut EDP No.
SERIES 7000L			14° INCLUDED ANGLE		
SL-1	1/4"	1/4"	5/8"	7L116ASC	7L116ADC
SL-2	5/16"	1/4"	7/8"	7L120ASC	7L120ADC
SL-3	3/8"	1/4"	1-1/16"	7L124ASC	7L124ADC
SL-4	1/2"	1/4"	1-1/8"	7L132ASC	7L132ADC
SL-5	5/8"	1/4"	1-3/16"	7L140ASC	7L140ADC
SL-6	5/8"	1/4"	1-5/16"	7L140BSC	7L140BDC
SL-7	3/4"	1/4"	1-1/2"	7L148ASC	7L148ADC
SERIES 7000L			MINIATURE		
SL-41	1/8"	1/8"	3/8"	70L041SC	70L041DC
SL-42	1/8"	1/8"	1/2"	70L042SC	70L042DC
SL-53	3/16"	1/8"	1/2"	70L053SC	70L053DC
SL-81	3/16"	3/16"	7/16"	70L081SC	70L081DC
SL-42L2	1/8"	1/8"	1/2"	7L42L2SC	7L42L2DC
SL-42L3	1/8"	1/8"	1/2"	7L42L3SC	7L42L3DC
SERIES 7000LX			6" EXTRA LONG		
SL-1L6	1/4"	1/4"	5/8"	7LX116SC	7LX116DC
SL-3L6	3/8"	1/4"	1-1/16"	7LX124SC	7LX124DC
SL-4L6	1/2"	1/4"	1-1/8"	7LX132SC	7LX132DC

Tool No.	Cutter Dia.	Shank Dia.	Length of Cut	Single Cut EDP No.	Double Cut EDP No.
SERIES 7000M			CONE SHAPE		
SM-1	1/4"	1/4"	1/2"	7M116ASC	7M116ADC
SM-2	1/4"	1/4"	3/4"	7M116BSC	7M116BDC
SM-3	1/4"	1/4"	1"	7M116CSC	7M116CDC
SM-3L	1/4"	1/4"	1-1/4"	7M116DSC	7M116DDC
SM-4	3/8"	1/4"	5/8"	7M124ASC	7M124ADC
SM-4L	3/8"	1/4"	1"	7M124BSC	7M124BDC
SM-5	1/2"	1/4"	7/8"	7M132ASC	7M132ADC
SM-6	5/8"	1/4"	1"	7M140ASC	7M140ADC
SERIES 7000M			MINIATURE		
SM-41	1/8"	1/8"	11/32"	70M041SC	70M041DC
SM-42	1/8"	1/8"	7/16"	70M042SC	70M042DC
SM-43	1/8"	1/8"	1/2"	70M043SC	70M043DC
SM-51	1/4"	1/8"	1/2"	70M051SC	70M051DC
SM-53	3/16"	1/8"	1/2"	70M053SC	70M053DC
SM-61	3/32"	3/32"	1/4"	70M061SC	70M061DC
SM-42L2	1/8"	1/8"	7/16"	7M42L2SC	7M42L2DC
SM-42L3	1/8"	1/8"	7/16"	7M42L3SC	7M42L3DC

SOLID CARBIDE Magnum



PACKAGING:
All sizes are individually packaged.

7000N/7000NE

MACHINING FROM THE REAR IN HARD TO REACH AREAS

Carbide burs are one of the most widely used and versatile cutting tools, used in virtually every industry. Manufactured from Tungsten Carbide, they are primarily used to remove burrs (the small flakes of metal) that often remain on the workpiece after the machining process. Burs are available in standard lengths, long series (for hard to reach applications), and in miniature sizes (for use in pencil grinders).



7000N



7000NE

SN Bur Profile



Tool No.	Cutter Dia.	Shank Dia.	Length of Cut	Single Cut EDP No.	Double Cut EDP No.
SERIES 7000N			INVERTED CONE		
SN-1	1/4"	1/4"	5/16"	7N116ASC	7N116ADC
SN-2	3/8"	1/4"	3/8"	7N124ASC	7N124ADC
SN-4	1/2"	1/4"	1/2"	7N132ASC	7N132ADC
SN-6	5/8"	1/4"	3/4"	7N140ASC	7N140ADC
SN-7	3/4"	1/4"	5/8"	7N148ASC	7N148ADC
SERIES 7000N			MINIATURE		
SN-41	1/8"	1/8"	1/8"	70N041SC	70N041DC
SN-42	1/8"	1/8"	3/16"	70N042SC	70N042DC
SN-51	1/4"	1/8"	1/4"	70N051SC	70N051DC
SN-53	3/16"	1/8"	1/4"	70N053SC	70N053DC
SN-61	3/32"	3/32"	1/8"	70N061SC	70N061DC
SN-81	3/16"	3/16"	1/4"	70N081SC	70N081DC
SERIES 7000NE			INVERTED CONE WITH END CUT		
SN-1E	1/4"	1/4"	5/16"	7N116ESC	7N116EDC
SN-2E	3/8"	1/4"	3/8"	7N124ESC	7N124EDC
SN-4E	1/2"	1/4"	1/2"	7N132ESC	7N132EDC
SN-7E	3/4"	1/4"	5/8"	7N148ESC	7N148EDC

Burs Aluminum/Non-Ferrous Cut

SOLID CARBIDE Magnum



PACKAGING:
All sizes are individually packaged.

Aluminum cut burs have more aggressive cutting edges for rapid stock removal with minimum chip. Ideal for aluminum and other non-ferrous materials.



7000AAL



7000CAL

Tool No.	Cutter Dia.	Shank Dia.	Length of Cut	EDP No.
SERIES 7000AAL		CYLINDRICAL		
SA-1NF	1/4"	1/4"	3/4"	7AAL116
SA-3NF	3/8"	1/4"	3/4"	7AAL124
SA-5NF	1/2"	1/4"	1"	7AAL132
SA-6NF	5/8"	1/4"	1"	7AAL140
SA-7NF	3/4"	1/4"	1"	7AAL148

Tool No.	Cutter Dia.	Shank Dia.	Length of Cut	EDP No.
SERIES 7000CAL		CYLINDRICAL BALL NOSE		
SC-1NF	1/4"	1/4"	3/4"	7CAL116
SC-3NF	3/8"	1/4"	3/4"	7CAL124
SC-5NF	1/2"	1/4"	1"	7CAL132
SC-6NF	5/8"	1/4"	1"	7CAL140
SC-7NF	3/4"	1/4"	1"	7CAL148



7000DAL



7000EAL

Tool No.	Cutter Dia.	Shank Dia.	Length of Cut	EDP No.
SERIES 7000DAL		BALL SHAPE		
SD-1NF	1/4"	1/4"	7/32"	7DAL116
SD-3NF	3/8"	1/4"	5/16"	7DAL124
SD-5NF	1/2"	1/4"	7/16"	7DAL132
SD-6NF	5/8"	1/4"	9/16"	7DAL140
SD-7NF	3/4"	1/4"	11/16"	7DAL148

Tool No.	Cutter Dia.	Shank Dia.	Length of Cut	EDP No.
SERIES 7000EAL		OVAL SHAPE		
SE-1NF	1/4"	1/4"	7/32"	7EAL116
SE-3NF	3/8"	1/4"	5/16"	7EAL124
SE-5NF	1/2"	1/4"	7/16"	7EAL132
SE-6NF	5/8"	1/4"	9/16"	7EAL140
SE-7NF	3/4"	1/4"	11/16"	7EAL148



7000FAL



7000LAL

Tool No.	Cutter Dia.	Shank Dia.	Length of Cut	EDP No.
SERIES 7000FAL		ROUND TREE SHAPE		
SF-1NF	1/4"	1/4"	3/4"	7FAL116
SF-3NF	3/8"	1/4"	3/4"	7FAL124
SF-5NF	1/2"	1/4"	1"	7FAL132
SF-6NF	5/8"	1/4"	1"	7FAL140
SF-14NF	3/4"	1/4"	1-1/4"	7FAL148

Tool No.	Cutter Dia.	Shank Dia.	Length of Cut	EDP No.
SERIES 7000LAL		14° INCLUDED ANGLE		
SL-1NF	1/4"	1/4"	5/8"	7LAL116
SL-3NF	3/8"	1/4"	1-1/16"	7LAL124
SL-4NF	1/2"	1/4"	1-1/8"	7LAL132
SL-5NF	5/8"	1/4"	1-3/16"	7LAL140
SL-6NF	5/8"	1/4"	1-5/16"	7LAL140A

Burs

Burs Sets

SOLID CARBIDE Magnum



Carbide burs are one of the most widely used and versatile cutting tools, used in virtually every industry. Manufactured from Tungsten Carbide, they are primarily used to remove burrs (the small flakes of metal) that often remain on the workpiece after the machining process. Burs are available in standard lengths, long series (for hard to reach applications), and in miniature sizes (for use in pencil grinders).



70S004DC

Set No.	No. of Pieces	Includes	Single Cut EDP No.	Double Cut EDP No.
Carbide Bur Sets				
1	8	SA-1, SC-1, SD-1, SE-1, SF-1, SG-1, SL-1, SM-1	70S001SC	70S001DC
2	8	SA-3, SC-3, SD-3, SE-3, SF-3, SG-3, SL-3, SM-4	70S002SC	70S002DC
3	8	SA-5, SC-5, SD-5, SE-5, SF-5, SG-5, SL-4, SM-5	70S003SC	70S003DC
4	10	SA-1, SA-3, SA-5, SC-1, SC-3, SC-5, SD-3, SF-3, SF-5, SH-1	70S004SC	70S004DC
5	10	SA-5, SC-3, SC-5, SD-5, SE-3, SF-3, SF-5, SG-3, SG-5, SL-4	70S005SC	70S005DC
6	8	SA-43, SC-42, SD-42, SE-41, SF-42, SG-42, SL-41, SN-42	70S006SC	70S006DC
7	8	SA-51, SB-51, SC-51, SD-51, SE-51, SF-51, SG-51, SM-51	70S007SC	70S007DC

Burs Displays

SOLID CARBIDE Magnum

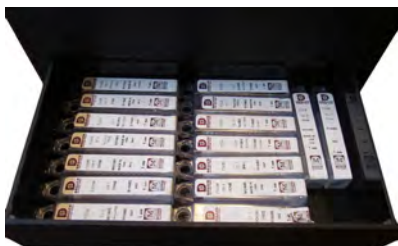

Storage drawer in back of display

- Burs are **“Made in the USA”** at our own state-of-the-art manufacturing facility
- A wide range of popular styles and sizes
- Comes complete with attractive, compact and light-weight acrylic display, ideal for your showroom and managing your inventory
- Display has a lock for added security. There is a shelf hidden in the back for holding additional replenishment inventory, or empty packages
- Available in 33, 66, or 99 pieces. The display will hold 33 pieces (1 of each). The 66 piece display will provide you with an extra piece of each for replenishment of the display. The 99 piece display will provide you with 2 extra pieces of each.
- Detailed labels (sample pictured below) make filling the display simple and easy

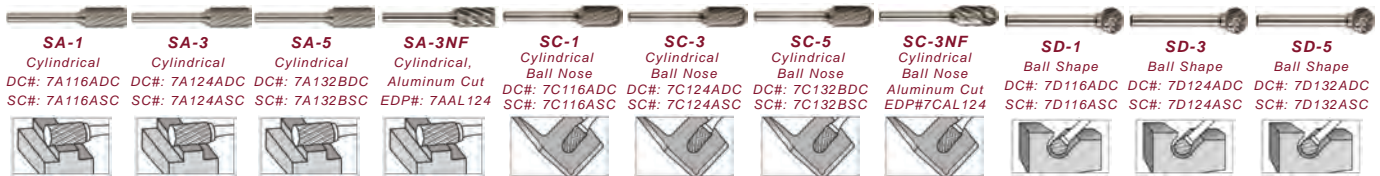

Displays	Each Set Contains The Following DC & NF Burs:	Single Cut EDP No.	Double Cut EDP No.
33 Piece Display (1 of Each Bur)	SA-1, SA-3, SA-5, SA-3NF, SC-1, SC-3, SC-5, SC-3NF, SD-1, SD-3, SD-5, SE-1, SE-3, SE-5,	70S033SC	70S033DC
66 Piece Display (2 of Each Bur)	SE-3NF, SF-1, SF-3, SF-5, SF-3NF, SG-1, SG-3, SG-5, SH-1, SH-5, SJ-1, SJ-3, SL-1, SL-3, SL-4,	70S066SC	70S066DC
99 Piece Display (3 of Each Bur)	SL-3NF, SM-1, SM-4, SM-5	70S099SC	70S099DC

Burs

Burs Fiberglass Routers

SOLID CARBIDE
Fractional



PACKAGING:
All sizes are individually packaged.

For use in graphite composite laminates, polyester glass reinforced products, and phenolic epoxy parts. Routers have a single end with a 30 degree left hand helix, right hand cut, and straight shank.

AVAILABLE AS SPECIALS. PLEASE CALL FOR PRICE AND DELIVERY.



8000



8100

Tool No.	Cutter Dia.	Shank Dia.	Flute Length	Overall Length	8000 EDP No.
SERIES 8000 NO END CUT					
FGR 1	1/16"	1/8"	3/16"	1-1/2"	80A104
FGR 1-1	3/32"	1/8"	3/8"	1-1/2"	80A106
FGR 2	1/8"	1/8"	1/2"	1-1/2"	80A108
FGR 3	3/16"	3/16"	5/8"	2"	80A112
FGR 4	3/16"	1/4"	5/8"	2"	80A112A
FGR 5	1/4"	1/4"	3/4"	2"	80A116
FGR 6	1/4"	1/4"	3/4"	2-1/2"	80A116A
FGR 6-1	1/4"	1/4"	1"	3"	80A116B
FGR 7	5/16"	5/16"	1"	2-1/2"	80A120
FGR 8	3/8"	3/8"	1"	2-1/2"	80A124
FGR 9	1/2"	1/2"	1"	3"	80A132

Tool No.	Cutter Dia.	Shank Dia.	Flute Length	Overall Length	8100 EDP No.
SERIES 8100 END MILL END					
FGR 1	1/16"	1/8"	3/16"	1-1/2"	81A104
FGR 1-1	3/32"	1/8"	3/8"	1-1/2"	81A106
FGR 2	1/8"	1/8"	1/2"	1-1/2"	81A108
FGR 3	3/16"	3/16"	5/8"	2"	81A112
FGR 4	3/16"	1/4"	5/8"	2"	81A112A
FGR 5	1/4"	1/4"	3/4"	2"	81A116
FGR 6	1/4"	1/4"	3/4"	2-1/2"	81A116A
FGR 6-1	1/4"	1/4"	1"	3"	81A116B
FGR 7	5/16"	5/16"	1"	2-1/2"	81A120
FGR 8	3/8"	3/8"	1"	2-1/2"	81A124
FGR 9	1/2"	1/2"	1"	3"	81A132



8300



8400

Tool No.	Cutter Dia.	Shank Dia.	Flute Length	Overall Length	8300 EDP No.
SERIES 8300 BUR END					
FGR 1	1/16"	1/8"	3/16"	1-1/2"	83A104
FGR 1-1	3/32"	1/8"	3/8"	1-1/2"	83A106
FGR 2	1/8"	1/8"	1/2"	1-1/2"	83A108
FGR 3	3/16"	3/16"	5/8"	2"	83A112
FGR 4	3/16"	1/4"	5/8"	2"	83A112A
FGR 5	1/4"	1/4"	3/4"	2"	83A116
FGR 6	1/4"	1/4"	3/4"	2-1/2"	83A116A
FGR 6-1	1/4"	1/4"	1"	3"	83A116B
FGR 7	5/16"	5/16"	1"	2-1/2"	83A120
FGR 8	3/8"	3/8"	1"	2-1/2"	83A124
FGR 9	1/2"	1/2"	1"	3"	83A132

Tool No.	Cutter Dia.	Shank Dia.	Flute Length	Overall Length	8400 EDP No.
SERIES 8400 DRILL END					
FGR 1	1/16"	1/8"	3/16"	1-1/2"	84A104
FGR 1-1	3/32"	1/8"	3/8"	1-1/2"	84A106
FGR 2	1/8"	1/8"	1/2"	1-1/2"	84A108
FGR 3	3/16"	3/16"	5/8"	2"	84A112
FGR 4	3/16"	1/4"	5/8"	2"	84A112A
FGR 5	1/4"	1/4"	3/4"	2"	84A116
FGR 6	1/4"	1/4"	3/4"	2-1/2"	84A116A
FGR 6-1	1/4"	1/4"	1"	3"	84A116B
FGR 7	5/16"	5/16"	1"	2-1/2"	84A120
FGR 8	3/8"	3/8"	1"	2-1/2"	84A124
FGR 9	1/2"	1/2"	1"	3"	84A132