

### 36 Pc. 1/4", 3/8", and 1/2" Drive Hex and Torx® Bit Socket Set

- Bits made of S2 steel for strength and durability
- Heat treated for maximum durability
- Hard stamped size markings
- Bright, full polish chrome finish easily wipes clean and resists corrosion
- Includes blow mold case for storage and organization
- Meets or exceeds ASME specifications



| Cat. No. | Included Storage | Product Weight |
|----------|------------------|----------------|
| 80726    | Blow Mold Case   | 3.86 lb        |



| Cat. No. | Description                          | Cat. No. | Description                            |
|----------|--------------------------------------|----------|--|
| 80172    | 1/4" Drive Torx® Bit Socket T10      | 80463    | 3/8" Drive External Torx® Socket E16   |
| 80173    | 1/4" Drive Torx® Bit Socket T15      | 80416    | 3/8" Drive Hex Bit SAE Socket 5/32"    |
| 80174    | 1/4" Drive Torx® Bit Socket T20      | 80417    | 3/8" Drive Hex Bit SAE Socket 3/16"    |
| 80175    | 1/4" Drive Torx® Bit Socket T25      | 80418    | 3/8" Drive Hex Bit SAE Socket 7/32"    |
| 80176D   | 1/4" Drive Torx® Bit Socket T27      | 80419    | 3/8" Drive Hex Bit SAE Socket 1/4"     |
| 80177D   | 1/4" Drive Torx® Bit Socket T30      | 80420    | 3/8" Drive Hex Bit SAE Socket 5/16"    |
| 80187    | 1/4" Drive External Torx® Socket E5  | 80421    | 3/8" Drive Hex Bit SAE Socket 3/8"     |
| 80188D   | 1/4" Drive External Torx® Socket E6  | 80422    | 3/8" Drive Hex Bit Metric Socket 2mm   |
| 80189    | 1/4" Drive External Torx® Socket E7  | 80423    | 3/8" Drive Hex Bit Metric Socket 2.5mm |
| 80190    | 1/4" Drive External Torx® Socket E8  | 80424    | 3/8" Drive Hex Bit Metric Socket 3mm   |
| 80451    | 3/8" Drive Torx® Bit Socket T40      | 80425    | 3/8" Drive Hex Bit Metric Socket 4mm   |
| 80452    | 3/8" Drive Torx® Bit Socket T45      | 80426    | 3/8" Drive Hex Bit Metric Socket 5mm   |
| 80453    | 3/8" Drive Torx® Bit Socket T47      | 80427    | 3/8" Drive Hex Bit Metric Socket 6mm   |
| 80454    | 3/8" Drive Torx® Bit Socket T50      | 80428D   | 3/8" Drive Hex Bit Metric Socket 7mm   |
| 80455    | 3/8" Drive Torx® Bit Socket T55      | 80429    | 3/8" Drive Hex Bit Metric Socket 8mm   |
| 80460    | 3/8" Drive External Torx® Socket E10 | 80430    | 3/8" Drive Hex Bit Metric Socket 9mm   |
| 80461    | 3/8" Drive External Torx® Socket E12 | 80431    | 3/8" Drive Hex Bit Metric Socket 10mm  |
| 80462    | 3/8" Drive External Torx® Socket E14 | 80669D   | 1/2" Drive External Torx® Socket E18   |

### 10 Pc. 3/8" and 1/2" Drive SAE Hex Bit Socket Set

- Bits made of S2 steel for strength and durability
- Heat treated for maximum durability
- Hard stamped size markings
- Bright, full polish chrome finish easily wipes clean and resists corrosion
- Includes socket rail for storage and organization
- Meets or exceeds ASME specifications



| Cat. No. | Included Storage | Product Weight |
|----------|------------------|----------------|
| 80579    | Socket Rail      | 1.99 lb        |



| Cat. No. | Description                         | Cat. No. | Description                         |
|----------|-------------------------------------|----------|-------------------------------------|
| 80414    | 3/8" Drive Hex Bit SAE Socket 1/8"  | 80420    | 3/8" Drive Hex Bit SAE Socket 5/16" |
| 80416    | 3/8" Drive Hex Bit SAE Socket 5/32" | 80421    | 3/8" Drive Hex Bit SAE Socket 3/8"  |

| Cat. No. | Description                         | Cat. No. | Description                         |
|----------|-------------------------------------|----------|-------------------------------------|
| 80417    | 3/8" Drive Hex Bit SAE Socket 3/16" | 80654    | 1/2" Drive Hex Bit SAE Socket 1/2"  |
| 80418    | 3/8" Drive Hex Bit SAE Socket 7/32" | 80655    | 1/2" Drive Hex Bit SAE Socket 9/16" |
| 80419    | 3/8" Drive Hex Bit SAE Socket 1/4"  | 80656    | 1/2" Drive Hex Bit SAE Socket 5/8"  |

### 10 Pc. 3/8" and 1/2" Drive Metric Hex Bit Socket Set

- Bits made of S2 steel for strength and durability
- Heat treated for maximum durability
- Hard stamped size markings
- Bright, full polish chrome finish easily wipes clean and resists corrosion
- Includes socket rail for storage and organization
- Meets or exceeds ASME specifications



| Cat. No. | Included Storage | Product Weight |
|----------|------------------|----------------|
| 80578    | Socket Rail      | 1.89 lb        |



| Cat. No. | Description                          | Cat. No. | Description                           |
|----------|--------------------------------------|----------|---------------------------------------|
| 80425    | 3/8" Drive Hex Bit Metric Socket 4mm | 80430    | 3/8" Drive Hex Bit Metric Socket 9mm  |
| 80426    | 3/8" Drive Hex Bit Metric Socket 5mm | 80431    | 3/8" Drive Hex Bit Metric Socket 10mm |
| 80427    | 3/8" Drive Hex Bit Metric Socket 6mm | 80661    | 1/2" Drive Hex Bit Metric Socket 12mm |
| 80428D   | 3/8" Drive Hex Bit Metric Socket 7mm | 80662    | 1/2" Drive Hex Bit Metric Socket 14mm |
| 80429    | 3/8" Drive Hex Bit Metric Socket 8mm | 80663    | 1/2" Drive Hex Bit Metric Socket 17mm |

### 36 Pc. 1/4", 3/8", and 1/2" Drive Torx® Bit Socket Set

- Set contains Torx® bit sockets, external Torx® bit sockets, tamper proof Torx® bit sockets
- Bits made of S2 steel for strength and durability
- Heat treated socket bases for durability
- Large, hard stamped markings offer easy size identification
- Bright, full polish chrome finish easily wipes clean and resists corrosion
- Black oxide finish is corrosion resistant on External Torx® sockets
- For use with manual drive tools only
- Includes blow mold case for storage and organization



| Cat. No. | Included Storage | Product Weight |
|----------|------------------|----------------|
| 80728    | Blow Mold Case   | 3.640 lb       |



| Cat. No. | Description                     | Cat. No. | Description                             |
|----------|---------------------------------|----------|---|
| -        | 1/4" Drive Torx® Bit Socket T8  | -        | 1/4" Drive External Torx® Bit Socket E7 |
| -        | 1/4" Drive Torx® Bit Socket T10 | -        | 1/4" Drive External Torx® Bit Socket E8 |

Continued on next page

**36 Pc. 1/4", 3/8", and 1/2" Drive Torx® Bit Socket Set** ■ *Continued from previous page*

| Cat. No. | Description                                  | Cat. No. | Description                                  |
|----------|--|----------|--|
| -        | 1/4" Drive Torx® Bit Socket T15              | -        | 3/8" Drive Torx® Bit Socket T40              |
| -        | 1/4" Drive Torx® Bit Socket T20              | -        | 3/8" Drive Torx® Bit Socket T45              |
| -        | 1/4" Drive Torx® Bit Socket T25              | -        | 3/8" Drive Torx® Bit Socket T47              |
| -        | 1/4" Drive Torx® Bit Socket T27              | -        | 3/8" Drive Torx® Bit Socket T50              |
| -        | 1/4" Drive Torx® Bit Socket T30              | -        | 3/8" Drive Torx® Bit Socket T55              |
| -        | 1/4" Drive Tamper-Proof Torx® Bit Socket T7  | -        | 3/8" Drive Tamper-Proof Torx® Bit Socket T40 |
| -        | 1/4" Drive Tamper-Proof Torx® Bit Socket T8  | -        | 3/8" Drive Tamper-Proof Torx® Bit Socket T45 |
| -        | 1/4" Drive Tamper-Proof Torx® Bit Socket T10 | -        | 3/8" Drive Tamper-Proof Torx® Bit Socket T50 |
| -        | 1/4" Drive Tamper-Proof Torx® Bit Socket T15 | -        | 3/8" Drive Tamper-Proof Torx® Bit Socket T55 |
| -        | 1/4" Drive Tamper-Proof Torx® Bit Socket T20 | -        | 3/8" Drive External Torx® Bit Socket E10     |
| -        | 1/4" Drive Tamper-Proof Torx® Bit Socket T25 | -        | 3/8" Drive External Torx® Bit Socket E12     |
| -        | 1/4" Drive Tamper-Proof Torx® Bit Socket T27 | -        | 3/8" Drive External Torx® Bit Socket E14     |
| -        | 1/4" Drive Tamper-Proof Torx® Bit Socket T30 | -        | 3/8" Drive External Torx® Bit Socket E16     |
| -        | 1/4" Drive External Torx® Bit Socket E4      | -        | 1/2" Drive Torx® Bit Socket, T50             |
| -        | 1/4" Drive External Torx® Bit Socket E5      | -        | 1/2" Drive External Torx® Bit Socket E18     |
| -        | 1/4" Drive External Torx® Bit Socket E6      | -        | 1/2" Drive External Torx® Bit Socket E20     |

**13 Pc. 1/4", 3/8", and 1/2" Drive Torx® Bit Socket Set**

- Bits made of S2 steel for strength and durability
- Heat treated for maximum durability
- Hard stamped size markings
- Bright, full polish chrome finish easily wipes clean and resists corrosion
- Includes socket rail for storage and organization
- Meets or exceeds ASME specifications



| Cat. No.     | Included Storage | Product Weight |
|--------------|------------------|----------------|
| <b>80723</b> | Socket Rail      | 1.32 lb        |

| Cat. No.      | Description                     | Cat. No.     | Description                     |
|---------------|---------------------------------|--------------|---------------------------------|
| <b>80171</b>  | 1/4" Drive Torx® Bit Socket T8  | <b>80451</b> | 3/8" Drive Torx® Bit Socket T40 |
| <b>80172</b>  | 1/4" Drive Torx® Bit Socket T10 | <b>80452</b> | 3/8" Drive Torx® Bit Socket T45 |
| <b>80173</b>  | 1/4" Drive Torx® Bit Socket T15 | <b>80453</b> | 3/8" Drive Torx® Bit Socket T47 |
| <b>80174</b>  | 1/4" Drive Torx® Bit Socket T20 | <b>80454</b> | 3/8" Drive Torx® Bit Socket T50 |
| <b>80175</b>  | 1/4" Drive Torx® Bit Socket T25 | <b>80455</b> | 3/8" Drive Torx® Bit Socket T55 |
| <b>80176D</b> | 1/4" Drive Torx® Bit Socket T27 | <b>80667</b> | 1/2" Drive Torx® Bit Socket T60 |
| <b>80177D</b> | 1/4" Drive Torx® Bit Socket T30 |              |                                 |

**10 Pc. 1/4" and 3/8" Drive Torx® Bit Socket Set**

- Bits made of S2 steel for strength and durability
- Heat treated for maximum durability
- Hard stamped size markings
- Bright, full polish chrome finish easily wipes clean and resists corrosion
- Includes socket rail for storage and organization
- Meets or exceeds ASME specifications



| Cat. No.     | Included Storage | Product Weight |
|--------------|------------------|----------------|
| <b>80722</b> | Socket Rail      | 0.98 lb        |

| Cat. No.      | Description                     | Cat. No.      | Description                     |
|---------------|---------------------------------|---------------|---------------------------------|
| <b>80172</b>  | 1/4" Drive Torx® Bit Socket T10 | <b>80177D</b> | 1/4" Drive Torx® Bit Socket T30 |
| <b>80173</b>  | 1/4" Drive Torx® Bit Socket T15 | <b>80451</b>  | 3/8" Drive Torx® Bit Socket T40 |
| <b>80174</b>  | 1/4" Drive Torx® Bit Socket T20 | <b>80452</b>  | 3/8" Drive Torx® Bit Socket T45 |
| <b>80175</b>  | 1/4" Drive Torx® Bit Socket T25 | <b>80454</b>  | 3/8" Drive Torx® Bit Socket T50 |
| <b>80176D</b> | 1/4" Drive Torx® Bit Socket T27 | <b>80455</b>  | 3/8" Drive Torx® Bit Socket T55 |

**10 Pc. 1/4" and 3/8" Drive Long Torx® Bit Socket Set**

- 6" overall length
- Bits made of S2 steel for strength and durability
- Heat-treated socket base for maximum durability
- Hard stamped size markings
- Meets or exceeds ASME specifications



| Cat. No.     | Included Storage | Product Weight |
|--------------|------------------|----------------|
| <b>80588</b> | Socket Rail      | 1.65 lb        |

| Cat. No.     | Description                          | Cat. No.     | Description                          |
|--------------|--------------------------------------|--------------|--------------------------------------|
| <b>82510</b> | 1/4" Drive Long Torx® Bit Socket T8  | <b>82515</b> | 1/4" Drive Long Torx® Bit Socket T27 |
| <b>82511</b> | 1/4" Drive Long Torx® Bit Socket T10 | <b>82516</b> | 1/4" Drive Long Torx® Bit Socket T30 |
| <b>82512</b> | 1/4" Drive Long Torx® Bit Socket T15 | <b>82517</b> | 3/8" Drive Long Torx® Bit Socket T40 |
| <b>82513</b> | 1/4" Drive Long Torx® Bit Socket T20 | <b>82518</b> | 3/8" Drive Long Torx® Bit Socket T45 |
| <b>82514</b> | 1/4" Drive Long Torx® Bit Socket T25 | <b>82519</b> | 3/8" Drive Long Torx® Bit Socket T50 |

### 13 Pc. 1/4", 3/8" and 1/2" Drive Torx® Stubby Bit Socket Set

- Reduced overall bit length provides better access in tight spaces
- S2 steel insert bits offer maximum strength
- Heat-treated socket base for durability
- Hard stamped size markings
- Bright, full polish chrome finish easily wipes clean and resists corrosion
- Includes socket rail for storage and organization
- Meets or exceeds ASME specifications



| Cat. No. | Included Storage | Product Weight |
|----------|------------------|----------------|
| 80898    | Socket Rail      | 1.13 lb        |

| Cat. No. | Description                            | Cat. No. | Description                            |
|----------|--|----------|--|
| 80883    | 1/4" Drive Stubby Torx® Bit Socket T8  | 80890    | 3/8" Drive Stubby Torx® Bit Socket T40 |
| 80884    | 1/4" Drive Stubby Torx® Bit Socket T10 | 80891    | 3/8" Drive Stubby Torx® Bit Socket T45 |
| 80885    | 1/4" Drive Stubby Torx® Bit Socket T15 | 80892    | 3/8" Drive Stubby Torx® Bit Socket T47 |
| 80886    | 1/4" Drive Stubby Torx® Bit Socket T20 | 80893    | 3/8" Drive Stubby Torx® Bit Socket T50 |
| 80887    | 1/4" Drive Stubby Torx® Bit Socket T25 | 80894    | 1/2" Drive Stubby Torx® Bit Socket T55 |
| 80888    | 1/4" Drive Stubby Torx® Bit Socket T27 | 80896    | 1/2" Drive Stubby Torx® Bit Socket T60 |
| 80889    | 1/4" Drive Stubby Torx® Bit Socket T30 |          |  |

### 10 Pc. 1/4 and 3/8" Drive Torx® Stubby Bit Driver Set

- Short overall length provides better access in tight spaces
- S2 steel for strength and durability
- Hard stamped size markings
- Satin finish for corrosion protection and simple cleaning
- Compact design provides additional access compared to standard bit sockets
- Includes socket rail for storage and organization

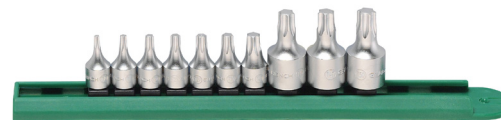

| Cat. No. | Included Storage | Product Weight |
|----------|------------------|----------------|
| 81196    | Socket Rail      | 0.46 lb        |

| Cat. No. | Description                                   | Cat. No. | Description                                   |
|----------|---|----------|---|
| 81184    | 1/4" Drive Stubby Torx® Bit Driver Socket T10 | 81189    | 1/4" Drive Stubby Torx® Bit Driver Socket T30 |
| 81185    | 1/4" Drive Stubby Torx® Bit Driver Socket T15 | 81190    | 1/4" Drive Stubby Torx® Bit Driver Socket T40 |
| 81186    | 1/4" Drive Stubby Torx® Bit Driver Socket T20 | 81191    | 3/8" Drive Stubby Torx® Bit Driver Socket T45 |
| 81187    | 1/4" Drive Stubby Torx® Bit Driver Socket T25 | 81192    | 3/8" Drive Stubby Torx® Bit Driver Socket T47 |
| 81188    | 1/4" Drive Stubby Torx® Bit Driver Socket T27 | 81193    | 3/8" Drive Stubby Torx® Bit Driver Socket T50 |

### 13 Pc. 1/4", 3/8", and 1/2" Drive Torx® Tamper Proof Bit Socket Set

- Bits made of S2 steel for strength and durability
- Heat treated for maximum durability
- Hard stamped size markings
- Bright, full polish chrome finish easily wipes clean and resists corrosion
- Includes socket rail for storage and organization
- Meets or exceeds ASME specifications



| Cat. No. | Included Storage | Product Weight |
|----------|------------------|----------------|
| 80725    | Socket Rail      | 1.38 lb        |

| Cat. No. | Description                                  | Cat. No. | Description                                   |
|----------|--|----------|---|
| 80178    | 1/4" Drive Tamper-Proof Torx® Bit Socket T7  | 80185    | 1/4" Drive Tamper-Proof Torx® Bit Socket T30  |
| 80179    | 1/4" Drive Tamper-Proof Torx® Bit Socket T8  | 80456D   | 3/8" Drive Tamper-Proof Torx® Bit Socket T40  |
| 80180    | 1/4" Drive Tamper-Proof Torx® Bit Socket T10 | 80457    | 3/8" Drive Tamper-Proof Torx® Bit Socket T45  |
| 80181    | 1/4" Drive Tamper-Proof Torx® Bit Socket T15 | 80458    | 3/8" Drive Tamper-Proof Torx® Bit Socket T50  |
| 80182    | 1/4" Drive Tamper-Proof Torx® Bit Socket T20 | 80459    | 3/8" Drive Tamper-Proof Torx® Bit Socket T55  |
| 80183    | 1/4" Drive Tamper-Proof Torx® Bit Socket T25 | 80668    | 1/2" Drive Tamper-Proof Torx® Bit Sockets T60 |
| 80184    | 1/4" Drive Tamper-Proof Torx® Bit Socket T27 |          |   |

### 11 Pc. 1/4" and 3/8" Drive Universal Stubby Tamper Proof Torx® Bit Socket Set

- For use with tamper proof security fasteners
- Universal joint allows for greater access
- Bits made of S2 steel for strength and durability
- Hard stamped size markings
- Bright, full polish chrome finish easily wipes clean and resists corrosion
- Includes socket rail for storage and organization



| Cat. No. | Included Storage | Product Weight |
|----------|------------------|----------------|
| 81052    | Socket Rail      | 1.30 lb        |

| Cat. No. | Description   | Cat. No. | Description   |
|----------|---|----------|---|
| 81040    | 1/4" Drive Universal Stubby Tamper Proof Torx® Bit Socket T8  | 81046    | 1/4" Drive Universal Stubby Tamper Proof Torx® Bit Socket T30 |
| 81041    | 1/4" Drive Universal Stubby Tamper Proof Torx® Bit Socket T10 | 81047    | 3/8" Drive Universal Stubby Tamper Proof Torx® Bit Socket T40 |
| 81042    | 1/4" Drive Universal Stubby Tamper Proof Torx® Bit Socket T15 | 81048    | 3/8" Drive Universal Stubby Tamper Proof Torx® Bit Socket T45 |
| 81043    | 1/4" Drive Universal Stubby Tamper Proof Torx® Bit Socket T20 | 81049    | 3/8" Drive Universal Stubby Tamper Proof Torx® Bit Socket T50 |
| 81044    | 1/4" Drive Universal Stubby Tamper Proof Torx® Bit Socket T25 | 81050    | 3/8" Drive Universal Stubby Tamper Proof Torx® Bit Socket T55 |
| 81045    | 1/4" Drive Universal Stubby Tamper Proof Torx® Bit Socket T27 |          |   |

### 13 Pc. 1/4", 3/8", and 1/2" Drive External Torx® Socket Set

- For use with external Torx® fasteners
- Black oxide finish is corrosion resistant
- Heat treated socket for durability
- Hard stamped size markings
- For use with manual drive tools only
- Includes socket rail for storage and organization



| Cat. No. | Included Storage | Product Weight |
|----------|------------------|----------------|
| 80583    | Socket Rail      | 2.08 lb        |

| Cat. No. | Description                          | Cat. No. | Description                          |
|----------|--------------------------------------|----------|--------------------------------------|
| 80186    | 1/4" Drive External Torx® Socket E4  | 80462    | 3/8" Drive External Torx® Socket E14 |
| 80187    | 1/4" Drive External Torx® Socket E5  | 80463    | 3/8" Drive External Torx® Socket E16 |
| 80188D   | 1/4" Drive External Torx® Socket E6  | 80669D   | 1/2" Drive External Torx® Socket E18 |
| 80189    | 1/4" Drive External Torx® Socket E7  | 80670    | 1/2" Drive External Torx® Socket E20 |
| 80190    | 1/4" Drive External Torx® Socket E8  | 80672    | 1/2" Drive External Torx® Socket E22 |
| 80460    | 3/8" Drive External Torx® Socket E10 | 80673    | 1/2" Drive External Torx® Socket E24 |
| 80461    | 3/8" Drive External Torx® Socket E12 |          |                                      |

### 10 Pc. 1/4", 3/8", and 1/2" Drive External Torx® Socket Set

- For use with external Torx® fasteners
- Black oxide finish is corrosion resistant
- Heat treated socket for durability
- Hard stamped size markings
- For use with manual drive tools only
- Includes socket rail for storage and organization



| Cat. No. | Included Storage | Product Weight |
|----------|------------------|----------------|
| 80582    | Socket Rail      | 1.59 lb        |

| Cat. No. | Description                         | Cat. No. | Description                          |
|----------|-------------------------------------|----------|--------------------------------------|
| 80186    | 1/4" Drive External Torx® Socket E4 | 80460    | 3/8" Drive External Torx® Socket E10 |
| 80187    | 1/4" Drive External Torx® Socket E5 | 80461    | 3/8" Drive External Torx® Socket E12 |
| 80188D   | 1/4" Drive External Torx® Socket E6 | 80462    | 3/8" Drive External Torx® Socket E14 |
| 80189    | 1/4" Drive External Torx® Socket E7 | 80463    | 3/8" Drive External Torx® Socket E16 |
| 80190    | 1/4" Drive External Torx® Socket E8 | 80669D   | 1/2" Drive External Torx® Socket E18 |

### 4 Pc. 3/8" and 1/2" Drive Triple Square Bit Socket Set

- Bits made of S2 steel for strength and durability
- Heat treated for maximum durability
- Hard stamped size markings
- Bright, full polish chrome finish easily wipes clean and resists corrosion
- Includes socket rail for storage and organization
- Meets or exceeds ASME specifications



| Cat. No. | Included Storage | Product Weight |
|----------|------------------|----------------|
| 80572    | Socket Rail      | 0.46 lb        |

| Cat. No. | Description                             | Cat. No. | Description                              |
|----------|---|----------|--|
| 80449    | 3/8" Drive Triple Square Bit Socket 6mm | 80665    | 1/2" Drive Triple Square Bit Socket 10mm |
| 80450    | 3/8" Drive Triple Square Bit Socket 8mm | 80666    | 1/2" Drive Triple Square Bit Socket 12mm |

### 5 Pc. 3/8" and 1/2" Drive Long Triple Square Bit Socket Set

- Longer overall bit length provides better access
- S2 steel insert bits offer maximum strength
- Heat treated for maximum durability
- Hard stamped size markings
- Bright, full polish chrome finish easily wipes clean and resists corrosion
- Includes socket rail for storage and organization
- Meets or exceeds ASME specifications



| Cat. No. | Included Storage | Product Weight |
|----------|------------------|----------------|
| 80874    | Socket Rail      | 1.66 lb        |

| Cat. No. | Description                              | Cat. No. | Description                              |
|----------|--|----------|--|
| 80868    | 3/8" Drive Triple Square Bit Socket 8mm  | 80871    | 1/2" Drive Triple Square Bit Socket 14mm |
| 80869    | 1/2" Drive Triple Square Bit Socket 10mm | 80872    | 1/2" Drive Triple Square Bit Socket 16mm |
| 80870    | 1/2" Drive Triple Square Bit Socket 12mm |          |  |

### 9 Pc. 1/4" Drive SAE Stubby Hex Bit Driver Set

- Short overall length provides better access in tight spaces
- S2 steel for strength and durability
- Hard stamped size markings
- Satin finish for corrosion protection and simple cleaning
- Compact design provides additional access compared to standard bit sockets
- Includes socket rail for storage and organization



| Cat. No. | Included Storage | Product Weight |
|----------|------------------|----------------|
| 81149    | Socket Rail      | 0.33 lb        |



| Cat. No. | Description                                       | Cat. No. | Description                                       |
|----------|---|----------|---|
| 81140    | 1/4" Drive Stubby Hex Bit SAE Driver Socket 3/32" | 81145    | 1/4" Drive Stubby Hex Bit SAE Driver Socket 7/32" |
| 81141    | 1/4" Drive Stubby Hex Bit SAE Driver Socket 7/64" | 81146    | 1/4" Drive Stubby Hex Bit SAE Driver Socket 1/4"  |
| 81142    | 1/4" Drive Stubby Hex Bit SAE Driver Socket 1/8"  | 81147    | 1/4" Drive Stubby Hex Bit SAE Driver Socket 5/16" |
| 81143    | 1/4" Drive Stubby Hex Bit SAE Driver Socket 5/32" | 81148    | 1/4" Drive Stubby Hex Bit SAE Driver Socket 3/8"  |
| 81144    | 1/4" Drive Stubby Hex Bit SAE Driver Socket 3/16" |          |   |

### 9 Pc. 1/4" Drive Metric Stubby Hex Bit Driver Set

- Short overall length provides better access in tight spaces
- S2 steel for strength and durability
- Hard stamped size markings
- Satin finish for corrosion protection and simple cleaning
- Compact design provides additional access compared to standard bit sockets
- Includes socket rail for storage and organization



| Cat. No. | Included Storage | Product Weight |
|----------|------------------|----------------|
| 81160    | Socket Rail      | 0.33 lb        |



| Cat. No. | Description  | Cat. No. | Description   |
|----------|--|----------|---|
| 81150    | 1/4" Drive Stubby Hex Bit Metric Driver Socket 2mm | 81155    | 1/4" Drive Stubby Hex Bit Metric Driver Socket 7mm  |
| 81151    | 1/4" Drive Stubby Hex Bit Metric Driver Socket 3mm | 81156    | 1/4" Drive Stubby Hex Bit Metric Driver Socket 8mm  |
| 81152    | 1/4" Drive Stubby Hex Bit Metric Driver Socket 4mm | 81157    | 1/4" Drive Stubby Hex Bit Metric Driver Socket 9mm  |
| 81153    | 1/4" Drive Stubby Hex Bit Metric Driver Socket 5mm | 81158    | 1/4" Drive Stubby Hex Bit Metric Driver Socket 10mm |
| 81154    | 1/4" Drive Stubby Hex Bit Metric Driver Socket 6mm |          |   |

### 10 Pc. 1/4" Drive Bit Driver Set

- Short overall length provides better access in tight spaces
- S2 steel for strength and durability
- Hard stamped size markings
- Satin finish for corrosion protection and simple cleaning
- Compact design provides additional access compared to standard bit sockets
- Includes socket rail for storage and organization

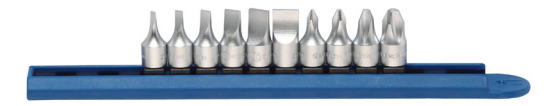

| Cat. No. | Included Storage | Product Weight |
|----------|------------------|----------------|
| 81180    | Socket Rail      | 0.370 lb       |



| Cat. No. | Description  | Cat. No. | Description  |
|----------|--|----------|--|
| 81176    | 1/4" Drive Stubby Phillips® Bit Driver Socket #1         | 81165    | 1/4" Drive Stubby Slotted Metric Bit Driver Socket 4mm   |
| 81177    | 1/4" Drive Stubby Phillips® Bit Driver Socket #2         | 81166    | 1/4" Drive Stubby Slotted Metric Bit Driver Socket 5.5mm |
| 81178    | 1/4" Drive Stubby Phillips® Bit Driver Socket #3         | 81167    | 1/4" Drive Stubby Slotted Metric Bit Driver Socket 8mm   |
| 81179    | 1/4" Drive Stubby Phillips® Bit Driver Socket #4         | 81168    | 1/4" Drive Stubby Slotted Metric Bit Driver Socket 10mm  |
| 81164    | 1/4" Drive Stubby Slotted Metric Bit Driver Socket 3.5mm | 81169    | 1/4" Drive Stubby Slotted Metric Bit Driver Socket 12mm  |

### 6 Pc. 1/4" Drive External Torx® Deep Socket Set

- For use with external torx fasteners
- Heat treated for maximum durability
- Double line (SAE) and knurled (metric) ring help easily identify standard and metric sockets
- Hard stamped size markings
- Bright, full polish chrome finish easily wipes clean and resists corrosion
- Includes socket rail for storage and organization
- Meets or exceeds ASME specifications



| Cat. No. | Included Storage | Product Weight |
|----------|------------------|----------------|
| 80322    | Socket Rail      | 0.46 lb        |



| Cat. No. | Description                              | Cat. No. | Description                               |
|----------|--|----------|---|
| 80191    | 1/4" Drive Deep External Torx® Socket E4 | 80194    | 1/4" Drive Deep External Torx® Socket E7  |
| 80192    | 1/4" Drive Deep External Torx® Socket E5 | 80195    | 1/4" Drive Deep External Torx® Socket E8  |
| 80193    | 1/4" Drive Deep External Torx® Socket E6 | 80196    | 1/4" Drive Deep External Torx® Socket E10 |

**1/4" Drive Hex Bit Sockets** ■ *Continued from previous page*

| Cat. No. | SAE/Metric | Fastener Size | Dim. A: Drive End | Dim. B: Nose Diameter | Dim. C: Overall Length | Dim. D: Bit Length | Product Weight |
|----------|------------|---------------|-------------------|-----------------------|------------------------|--------------------|----------------|
| 80157    | SAE        | 5/32 in       | 0.508 in          | 0.508 in              | 1.53 in                | 0.984 in           | 0.05 lb        |
| 80158    | SAE        | 3/16 in       | 0.508 in          | 0.508 in              | 1.53 in                | 0.984 in           | 0.05 lb        |
| 80159    | SAE        | 7/32 in       | 0.508 in          | 0.508 in              | 1.53 in                | 0.984 in           | 0.05 lb        |
| 80160    | SAE        | 1/4 in        | 0.508 in          | 0.508 in              | 1.53 in                | 0.984 in           | 0.05 lb        |
| 80161    | Metric     | 2 mm          | 0.508 in          | 0.508 in              | 1.53 in                | 0.984 in           | 0.05 lb        |
| 80162    | Metric     | 2.5 mm        | 0.508 in          | 0.508 in              | 1.53 in                | 0.984 in           | 0.05 lb        |
| 80163    | Metric     | 3 mm          | 0.508 in          | 0.508 in              | 1.53 in                | 0.984 in           | 0.05 lb        |
| 80164    | Metric     | 4 mm          | 0.508 in          | 0.508 in              | 1.53 in                | 0.984 in           | 0.05 lb        |
| 80165    | Metric     | 5 mm          | 0.508 in          | 0.508 in              | 1.53 in                | 0.984 in           | 0.05 lb        |
| 80166    | Metric     | 6 mm          | 0.508 in          | 0.508 in              | 1.53 in                | 0.984 in           | 0.05 lb        |

**1/4" Drive Stubby Hex Bit Drivers**

- Short overall length provides better access in tight spaces
- S2 steel for strength and durability
- Hard stamped size markings
- Satin finish for corrosion protection and simple cleaning
- Compact design provides additional access compared to standard bit sockets



| Cat. No. | SAE/Metric | Fastener Size | Dim. A: Drive End | Dim. C: Overall Length | Product Weight |
|----------|------------|---------------|-------------------|------------------------|----------------|
| 81140    | SAE        | 3/32 in       | 0.472 in          | 0.98 in                | 0.02 lb        |
| 81141    | SAE        | 7/64 in       | 0.472 in          | 0.98 in                | 0.02 lb        |
| 81142    | SAE        | 1/8 in        | 0.472 in          | 0.98 in                | 0.02 lb        |
| 81143    | SAE        | 5/32 in       | 0.472 in          | 0.98 in                | 0.02 lb        |
| 81144    | SAE        | 3/16 in       | 0.472 in          | 0.98 in                | 0.02 lb        |
| 81145    | SAE        | 7/32 in       | 0.472 in          | 0.98 in                | 0.02 lb        |
| 81146    | SAE        | 1/4 in        | 0.472 in          | 0.98 in                | 0.03 lb        |
| 81147    | SAE        | 5/16 in       | 0.472 in          | 0.98 in                | 0.03 lb        |
| 81148    | SAE        | 3/8 in        | 0.472 in          | 0.98 in                | 0.03 lb        |
| 81150    | Metric     | 2 mm          | 0.472 in          | 0.98 in                | 0.02 lb        |
| 81151    | Metric     | 3 mm          | 0.472 in          | 0.98 in                | 0.02 lb        |
| 81152    | Metric     | 4 mm          | 0.472 in          | 0.98 in                | 0.02 lb        |
| 81153    | Metric     | 5 mm          | 0.472 in          | 0.98 in                | 0.02 lb        |
| 81154    | Metric     | 6 mm          | 0.472 in          | 0.98 in                | 0.02 lb        |
| 81155    | Metric     | 7 mm          | 0.472 in          | 0.98 in                | 0.02 lb        |
| 81156    | Metric     | 8 mm          | 0.472 in          | 0.98 in                | 0.03 lb        |
| 81157    | Metric     | 9 mm          | 0.472 in          | 0.98 in                | 0.03 lb        |
| 81158    | Metric     | 10 mm         | 0.472 in          | 0.98 in                | 0.03 lb        |

**1/4" Drive Torx® Bit Sockets**

- S2 steel insert bits offer maximum strength
- Heat-treated socket base for durability
- Hard stamped size markings
- Double line (SAE) and knurled (metric) ring help easily identify standard and metric sockets
- Bright, full polish chrome finish easily wipes clean and resists corrosion
- Meets or exceeds ASME specifications

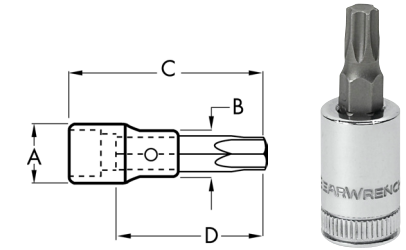

| Cat. No. | Drive Type | Fastener Size | Dim. A: Drive End | Dim. B: Nose Diameter | Dim. C: Overall Length | Dim. D: Bit Length | Product Weight |
|----------|------------|---------------|-------------------|-----------------------|------------------------|--------------------|----------------|
| 80171    | Torx®      | T8            | 0.508 in          | 0.508 in              | 1.53 in                | 0.984 in           | 0.05 lb        |
| 80172    | Torx®      | T10           | 0.508 in          | 0.508 in              | 1.53 in                | 0.984 in           | 0.05 lb        |
| 80173    | Torx®      | T15           | 0.508 in          | 0.508 in              | 1.53 in                | 0.984 in           | 0.05 lb        |
| 80174    | Torx®      | T20           | 0.508 in          | 0.508 in              | 1.53 in                | 0.984 in           | 0.05 lb        |
| 80175    | Torx®      | T25           | 0.508 in          | 0.508 in              | 1.53 in                | 0.984 in           | 0.05 lb        |
| 80176D   | Torx®      | T27           | 0.508 in          | 0.508 in              | 1.53 in                | 0.984 in           | 0.05 lb        |
| 80177D   | Torx®      | T30           | 0.508 in          | 0.508 in              | 1.53 in                | 0.984 in           | 0.05 lb        |

**1/4" Drive Long Torx® Bit Sockets**

- S2 steel insert bits offer maximum strength
- Heat-treated socket base for durability
- Hard stamped size markings
- Double line (SAE) and knurled (metric) ring help easily identify standard and metric sockets
- Bright, full polish chrome finish easily wipes clean and resists corrosion
- Meets or exceeds ASME specifications

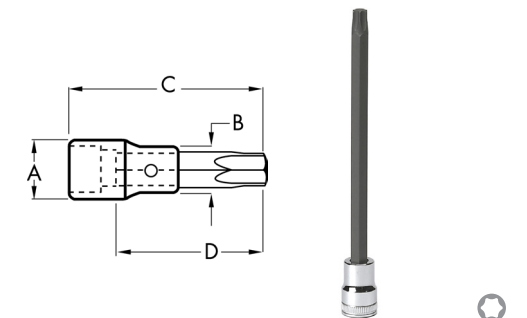

| Cat. No. | Drive Type | Fastener Size | Dim. A: Drive End | Dim. B: Nose Diameter | Dim. C: Overall Length | Dim. D: Bit Length | Product Weight |
|----------|------------|---------------|-------------------|-----------------------|------------------------|--------------------|----------------|
| 82510    | Torx®      | T8            | 0.508 in          | 0.508 in              | 5.98 in                | 5.393 in           | 0.125 lb       |
| 82511    | Torx®      | T10           | 0.508 in          | 0.508 in              | 5.98 in                | 5.393 in           | 0.125 lb       |
| 82512    | Torx®      | T15           | 0.508 in          | 0.508 in              | 5.98 in                | 5.393 in           | 0.15 lb        |
| 82513    | Torx®      | T20           | 0.508 in          | 0.508 in              | 5.98 in                | 5.393 in           | 0.15 lb        |
| 82514    | Torx®      | T25           | 0.508 in          | 0.508 in              | 5.98 in                | 5.393 in           | 0.15 lb        |
| 82515    | Torx®      | T27           | 0.508 in          | 0.508 in              | 5.98 in                | 5.393 in           | 0.15 lb        |
| 82516    | Torx®      | T30           | 0.508 in          | 0.508 in              | 5.98 in                | 5.393 in           | 0.18 lb        |

### 1/4" Drive Stubby Torx® Bit Sockets

- Reduced overall bit length provides better access in tight spaces
- S2 steel insert bits offer maximum strength
- Heat-treated socket base for durability
- Hard stamped size markings
- Bright, full polish chrome finish easily wipes clean and resists corrosion
- Meets or exceeds ASME specifications

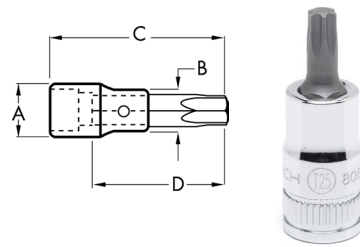

| Cat. No. | Drive Type | Fastener Size | Dim. A: Drive End | Dim. B: Nose Diameter | Dim. C: Overall Length | Dim. D: Bit Length | Product Weight |
|----------|------------|---------------|-------------------|-----------------------|------------------------|--------------------|----------------|
| 80883    | Torx®      | T8            | 0.465 in          | 0.423 in              | 1.34 in                | 0.866 in           | 0.03 lb        |
| 80884    | Torx®      | T10           | 0.465 in          | 0.423 in              | 1.34 in                | 0.866 in           | 0.03 lb        |
| 80885    | Torx®      | T15           | 0.465 in          | 0.423 in              | 1.34 in                | 0.866 in           | 0.03 lb        |
| 80886    | Torx®      | T20           | 0.465 in          | 0.423 in              | 1.34 in                | 0.866 in           | 0.03 lb        |
| 80887    | Torx®      | T25           | 0.465 in          | 0.423 in              | 1.34 in                | 0.866 in           | 0.03 lb        |
| 80888    | Torx®      | T27           | 0.465 in          | 0.423 in              | 1.34 in                | 0.866 in           | 0.03 lb        |
| 80889    | Torx®      | T30           | 0.465 in          | 0.423 in              | 1.34 in                | 0.866 in           | 0.03 lb        |

### 1/4" Drive Stubby Torx® Bit Drivers

- Short overall length provides better access in tight spaces
- S2 steel for strength and durability
- Hard stamped size markings
- Satin finish for corrosion protection and simple cleaning
- Compact design provides additional access compared to standard bit sockets



| Cat. No. | Drive Type | Fastener Size | Dim. A: Drive End | Dim. C: Overall Length | Product Weight |
|----------|------------|---------------|-------------------|------------------------|----------------|
| 81184    | Torx®      | T10           | 0.472 in          | 0.98 in                | 0.02 lb        |
| 81185    | Torx®      | T15           | 0.472 in          | 0.98 in                | 0.02 lb        |
| 81186    | Torx®      | T20           | 0.472 in          | 0.98 in                | 0.02 lb        |
| 81187    | Torx®      | T25           | 0.472 in          | 0.98 in                | 0.02 lb        |
| 81188    | Torx®      | T27           | 0.472 in          | 0.98 in                | 0.02 lb        |
| 81189    | Torx®      | T30           | 0.472 in          | 0.98 in                | 0.02 lb        |
| 81190    | Torx®      | T40           | 0.472 in          | 0.98 in                | 0.08 lb        |

### 1/4" Drive Tamper-Proof Torx® Bit Sockets

- For use with tamper-proof security fasteners
- S2 steel insert bits offer maximum strength
- Heat-treated socket base for durability
- Hard stamped size markings
- Double line (SAE) and knurled (metric) ring help easily identify standard and metric sockets
- Bright, full polish chrome finish easily wipes clean and resists corrosion
- Meets or exceeds ASME specifications

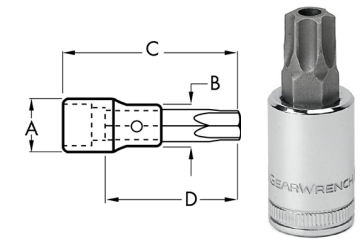

| Cat. No. | Drive Type         | Fastener Size | Dim. A: Drive End | Dim. B: Nose Diameter | Dim. C: Overall Length | Dim. D: Bit Length | Product Weight |
|----------|--------------------|---------------|-------------------|-----------------------|------------------------|--------------------|----------------|
| 80178    | Tamper-Proof Torx® | T7            | 0.508 in          | 0.508 in              | 1.53 in                | 0.984 in           | 0.05 lb        |
| 80179    | Tamper-Proof Torx® | T8            | 0.508 in          | 0.508 in              | 1.53 in                | 0.984 in           | 0.05 lb        |
| 80180    | Tamper-Proof Torx® | T10           | 0.508 in          | 0.508 in              | 1.53 in                | 0.984 in           | 0.05 lb        |
| 80181    | Tamper-Proof Torx® | T15           | 0.508 in          | 0.508 in              | 1.53 in                | 0.984 in           | 0.05 lb        |
| 80182    | Tamper-Proof Torx® | T20           | 0.508 in          | 0.508 in              | 1.53 in                | 0.984 in           | 0.05 lb        |
| 80183    | Tamper-Proof Torx® | T25           | 0.508 in          | 0.508 in              | 1.53 in                | 0.984 in           | 0.05 lb        |
| 80184    | Tamper-Proof Torx® | T27           | 0.508 in          | 0.508 in              | 1.53 in                | 0.984 in           | 0.05 lb        |
| 80185    | Tamper-Proof Torx® | T30           | 0.508 in          | 0.508 in              | 1.53 in                | 0.984 in           | 0.05 lb        |

### 1/4" Drive Universal Stubby Tamper-Proof Torx® Bit Sockets

- For use with tamper proof security fasteners
- Universal joint allows for greater access
- Bits made of S2 steel for strength and durability
- Optimized overall length provides even more access in tight spaces
- Hard stamped size markings
- Bright, full polish chrome finish easily wipes clean and resists corrosion



| Cat. No. | Drive Type         | Fastener Size | Dim. A: Drive End | Dim. B: Nose Diameter | Dim. C: Overall Length | Exposed Bit Length | Product Weight |
|----------|--------------------|---------------|-------------------|-----------------------|------------------------|--------------------|----------------|
| 81040    | Tamper-Proof Torx® | T8            | 0.543 in          | 0.543 in              | 1.93 in                | 0.472 in           | 0.07 lb        |
| 81041    | Tamper-Proof Torx® | T10           | 0.543 in          | 0.543 in              | 1.93 in                | 0.472 in           | 0.07 lb        |
| 81042    | Tamper-Proof Torx® | T15           | 0.543 in          | 0.543 in              | 1.93 in                | 0.472 in           | 0.07 lb        |
| 81043    | Tamper-Proof Torx® | T20           | 0.543 in          | 0.543 in              | 1.93 in                | 0.472 in           | 0.07 lb        |
| 81044    | Tamper-Proof Torx® | T25           | 0.543 in          | 0.543 in              | 1.93 in                | 0.472 in           | 0.07 lb        |
| 81045    | Tamper-Proof Torx® | T27           | 0.543 in          | 0.543 in              | 1.93 in                | 0.472 in           | 0.07 lb        |
| 81046    | Tamper-Proof Torx® | T30           | 0.543 in          | 0.543 in              | 1.93 in                | 0.472 in           | 0.07 lb        |

### 1/4" Drive External Torx® Sockets

- For use with external torx fasteners
- Black oxide finish is corrosion resistant
- Heat-treated socket for durability
- Hard stamped size markings
- For use with manual drive tools only



| Cat. No. | Drive Type     | Fastener Size | Dim. A: Drive End | Dim. B: Nose Diameter | Dim. C: Overall Length | Dim. D: Bolt Clearance | Dim. E: Bolt Depth | Product Weight |
|----------|----------------|---------------|-------------------|-----------------------|------------------------|------------------------|--------------------|----------------|
| 80186    | External Torx® | E4            | 0.508 in          | 0.251 in              | 0.984 in               | 0.078 in               | 0.137 in           | 0.13 lb        |
| 80187    | External Torx® | E5            | 0.508 in          | 0.295 in              | 0.984 in               | 0.098 in               | 0.196 in           | 0.13 lb        |
| 80188D   | External Torx® | E6            | 0.508 in          | 0.322 in              | 0.984 in               | 0.11 in                | 0.255 in           | 0.13 lb        |
| 80189    | External Torx® | E7            | 0.508 in          | 0.370 in              | 0.984 in               | 0.15 in                | 0.255 in           | 0.13 lb        |
| 80190    | External Torx® | E8            | 0.508 in          | 0.437 in              | 0.984 in               | 0.15 in                | 0.255 in           | 0.13 lb        |

### 1/4" Drive Deep External Torx® Sockets

- For use with external torx fasteners
- Heat treated for maximum durability
- Double line (SAE) and knurled (metric) ring help easily identify standard and metric sockets
- Hard stamped size markings
- Bright, full polish chrome finish easily wipes clean and resists corrosion
- Meets or exceeds ASME specifications



| Cat. No. | Drive Type     | Fastener Size | Dim. A: Drive End | Dim. B: Nose Diameter | Dim. C: Overall Length | Product Weight |
|----------|----------------|---------------|-------------------|-----------------------|------------------------|----------------|
| 80191    | External Torx® | E4            | 0.470 in          | 0.224 in              | 1.968 in               | 0.20 lb        |
| 80192    | External Torx® | E5            | 0.470 in          | 0.275 in              | 1.968 in               | 0.20 lb        |
| 80193    | External Torx® | E6            | 0.470 in          | 0.314 in              | 1.968 in               | 0.20 lb        |
| 80194    | External Torx® | E7            | 0.470 in          | 0.354 in              | 1.968 in               | 0.20 lb        |
| 80195    | External Torx® | E8            | 0.470 in          | 0.393 in              | 1.968 in               | 0.20 lb        |
| 80196    | External Torx® | E10           | 0.470 in          | 0.47 in               | 1.968 in               | 0.20 lb        |
| 80243    | External Torx® | E11           | 0.470 in          | -                     | 1.968 in               | 0.25 lb        |

### 1/4" Drive Stubby Bit Drivers

- Short overall length provides better access in tight spaces
- S2 steel for strength and durability
- Hard stamped size markings
- Satin finish for corrosion protection and simple cleaning
- Compact design provides additional access compared to standard bit sockets



| Cat. No. | Drive Type | Fastener Size | Dim. A: Drive End | Dim. C: Overall Length | Product Weight |
|----------|------------|---------------|-------------------|------------------------|----------------|
| 81176    | Phillips®  | #1            | 0.472 in          | 0.98 in                | 0.02 lb        |
| 81177    | Phillips®  | #2            | 0.472 in          | 0.98 in                | 0.02 lb        |
| 81178    | Phillips®  | #3            | 0.472 in          | 0.98 in                | 0.02 lb        |
| 81179    | Phillips®  | #4            | 0.472 in          | 0.98 in                | 0.02 lb        |
| 81164    | Slotted    | 3.5 mm        | 0.472 in          | 0.98 in                | 0.02 lb        |
| 81165    | Slotted    | 4 mm          | 0.472 in          | 0.98 in                | 0.02 lb        |
| 81166    | Slotted    | 5.5 mm        | 0.472 in          | 0.98 in                | 0.02 lb        |
| 81167    | Slotted    | 8 mm          | 0.472 in          | 0.98 in                | 0.02 lb        |
| 81168    | Slotted    | 10 mm         | 0.472 in          | 0.98 in                | 0.02 lb        |
| 81169    | Slotted    | 12 mm         | 0.472 in          | 0.98 in                | 0.02 lb        |

### 1/4" Drive Stubby Triple Square Bit Drivers

- Short overall length provides better access in tight spaces
- S2 steel for strength and durability
- Hard stamped size markings
- Satin finish for corrosion protection and simple cleaning
- Compact design provides additional access compared to standard bit sockets



| Cat. No. | SAE/Metric | Fastener Size | Dim. A: Drive End | Dim. C: Overall Length | Dim. D: Bit Length | Product Weight |
|----------|------------|---------------|-------------------|------------------------|--------------------|----------------|
| 81090    | Metric     | 4 mm          | 0.472 in          | 0.98 in                | 0.187 in           | 0.02 lb        |
| 81091    | Metric     | 5 mm          | 0.472 in          | 0.98 in                | 0.187 in           | 0.02 lb        |
| 81092    | Metric     | 6 mm          | 0.472 in          | 0.98 in                | 0.187 in           | 0.02 lb        |

### 7 Pc. 3/8" Drive SAE Long Ball End Hex Bit Socket Set

- Ball end allows up to a 25° entry angle to work in hard to reach places
- 6" overall length
- Bits made of S2 steel for strength and durability
- Heat-treated socket base for maximum durability
- Hard stamped size markings
- Bright, full polish chrome finish easily wipes clean and resists corrosion
- Includes socket rail for storage and organization
- Meets or exceeds ASME specifications



| Cat. No. | Included Storage | Product Weight |
|----------|------------------|----------------|
| 80574    | Socket Rail      | 1.13 lb        |



| Cat. No. | Description                                       | Cat. No. | Description                                       |
|----------|---|----------|---|
| 80434    | 3/8" Drive Long Ball End Hex Bit SAE Socket 1/8"  | 80438    | 3/8" Drive Long Ball End Hex Bit SAE Socket 1/4"  |
| 80435    | 3/8" Drive Long Ball End Hex Bit SAE Socket 5/32" | 80439    | 3/8" Drive Long Ball End Hex Bit SAE Socket 5/16" |
| 80436D   | 3/8" Drive Long Ball End Hex Bit SAE Socket 3/16" | 80440    | 3/8" Drive Long Ball End Hex Bit SAE Socket 3/8"  |
| 80437    | 3/8" Drive Long Ball End Hex Bit SAE Socket 7/32" |          |   |

### 8 Pc. 3/8" Drive Metric Long Ball End Hex Bit Socket Set

- Ball end allows up to a 25° entry angle to work in hard to reach places
- 6" overall length
- Bits made of S2 steel for strength and durability
- Heat-treated socket base for maximum durability
- Hard stamped size markings
- Bright, full polish chrome finish easily wipes clean and resists corrosion
- Includes socket rail for storage and organization
- Meets or exceeds ASME specifications



| Cat. No. | Included Storage | Product Weight |
|----------|------------------|----------------|
| 80573    | Socket Rail      | 1.59 lb        |



| Cat. No. | Description  | Cat. No. | Description   |
|----------|--|----------|---|
| 80441    | 3/8" Drive Long Ball End Hex Bit Metric Socket 3mm | 80445    | 3/8" Drive Long Ball End Hex Bit Metric Socket 7mm  |
| 80442    | 3/8" Drive Long Ball End Hex Bit Metric Socket 4mm | 80446    | 3/8" Drive Long Ball End Hex Bit Metric Socket 8mm  |
| 80443    | 3/8" Drive Long Ball End Hex Bit Metric Socket 5mm | 80447    | 3/8" Drive Long Ball End Hex Bit Metric Socket 9mm  |
| 80444    | 3/8" Drive Long Ball End Hex Bit Metric Socket 6mm | 80448    | 3/8" Drive Long Ball End Hex Bit Metric Socket 10mm |

### 7 Pc. 3/8" Drive Bit Socket Set

- Heat treated for maximum durability
- Bits made of S2 steel for strength and durability
- Hard stamped size markings
- Bright, full polish chrome finish easily wipes clean and resists corrosion
- Includes socket rail for storage and organization
- Meets or exceeds ASME specifications



| Cat. No. | Included Storage | Product Weight |
|----------|------------------|----------------|
| 80577    | Socket Rail      | 0.70 lb        |



| Cat. No. | Description                        | Cat. No. | Description                       |
|----------|------------------------------------|----------|-----------------------------------|
| 80467    | 3/8" Drive Phillips® Bit Socket #1 | 80464    | 3/8" Drive Slotted Bit Socket 4mm |
| 80468    | 3/8" Drive Phillips® Bit Socket #2 | 80465    | 3/8" Drive Slotted Bit Socket 5mm |
| 80469    | 3/8" Drive Phillips® Bit Socket #3 | 80466    | 3/8" Drive Slotted Bit Socket 6mm |
| 80470    | 3/8" Drive Pozidriv® Bit Socket #2 |          |                                   |

### 9 Pc. 3/8" Drive Universal External Torx® Socket Set

- Universal joint allows for greater access
- Hard stamped size markings
- Bright, full polish chrome finish easily wipes clean and resists corrosion
- Includes socket rail for storage and organization



| Cat. No. | Included Storage | Product Weight |
|----------|------------------|----------------|
| 80985    | Socket Rail      | 1.34 lb        |



| Cat. No. | Description                                    | Cat. No. | Description                                     |
|----------|--|----------|---|
| 80976    | 3/8" Drive Universal External Torx® Sockets E4 | 80981    | 3/8" Drive Universal External Torx® Sockets E10 |
| 80977    | 3/8" Drive Universal External Torx® Sockets E5 | 80982    | 3/8" Drive Universal External Torx® Sockets E12 |
| 80978    | 3/8" Drive Universal External Torx® Sockets E6 | 80983    | 3/8" Drive Universal External Torx® Sockets E14 |
| 80979    | 3/8" Drive Universal External Torx® Sockets E7 | 80984    | 3/8" Drive Universal External Torx® Sockets E16 |
| 80980    | 3/8" Drive Universal External Torx® Sockets E8 |          |   |

### 3/8" Drive Torx® Bit Sockets

- Heat-treated socket base for durability
- S2 steel insert bits offer maximum strength
- Double line (SAE) and knurled (metric) ring help easily identify standard and metric sockets
- Hard stamped size markings
- Bright, full polish chrome finish easily wipes clean and resists corrosion
- Meets or exceeds ASME specifications

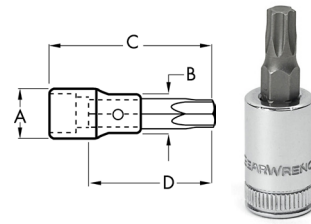

| Cat. No. | Fastener Size | Dim. A: Drive End | Dim. B: Nose Diameter | Dim. C: Overall Length | Dim. D: Bit Length | Product Weight |
|----------|---------------|-------------------|-----------------------|------------------------|--------------------|----------------|
| 80534    | T15           | 0.688 in          | 0.590 in              | 1.85 in                | 0.984 in           | 0.12 lb        |
| 80535    | T20           | 0.688 in          | 0.590 in              | 1.85 in                | 0.984 in           | 0.12 lb        |
| 80536    | T25           | 0.688 in          | 0.590 in              | 1.85 in                | 0.984 in           | 0.14 lb        |
| 80537    | T27           | 0.688 in          | 0.590 in              | 1.85 in                | 0.984 in           | 0.15 lb        |
| 80538    | T30           | 0.688 in          | 0.590 in              | 1.85 in                | 0.984 in           | 0.15 lb        |
| 80451    | T40           | 0.688 in          | 0.590 in              | 1.85 in                | 1.181 in           | 0.18 lb        |
| 80452    | T45           | 0.688 in          | 0.590 in              | 1.85 in                | 1.181 in           | 0.18 lb        |
| 80453    | T47           | 0.688 in          | 0.590 in              | 1.85 in                | 1.181 in           | 0.18 lb        |
| 80454    | T50           | 0.688 in          | 0.590 in              | 1.85 in                | 1.181 in           | 0.20 lb        |
| 80455    | T55           | 0.688 in          | 0.590 in              | 1.85 in                | 1.181 in           | 0.20 lb        |

### 3/8" Drive Long Torx® Bit Sockets

- Heat-treated socket base for durability
- S2 steel insert bits offer maximum strength
- Double line (SAE) and knurled (metric) ring help easily identify standard and metric sockets
- Hard stamped size markings
- Bright, full polish chrome finish easily wipes clean and resists corrosion
- Meets or exceeds ASME specifications

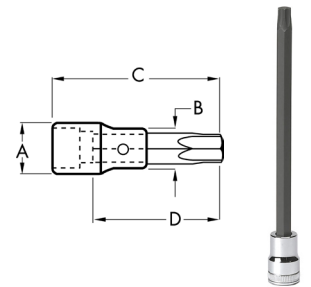

| Cat. No. | Fastener Size | Dim. A: Drive End | Dim. B: Nose Diameter | Dim. C: Overall Length | Dim. D: Bolt Clearance | Product Weight |
|----------|---------------|-------------------|-----------------------|------------------------|------------------------|----------------|
| 82517    | T40           | 0.688 in          | 0.590 in              | 5.984 in               | 5.196 in               | 0.45 lb        |
| 82518    | T45           | 0.688 in          | 0.590 in              | 5.984 in               | 5.196 in               | 0.48 lb        |
| 82519    | T50           | 0.688 in          | 0.590 in              | 5.984 in               | 5.196 in               | 0.52 lb        |

### 3/8" Drive Stubby Torx® Bit Sockets

- Reduced overall bit length provides better access in tight spaces
- S2 steel insert bits offer maximum strength
- Heat-treated socket base for durability
- Hard stamped size markings
- Bright, full polish chrome finish easily wipes clean and resists corrosion
- Meets or exceeds ASME specifications

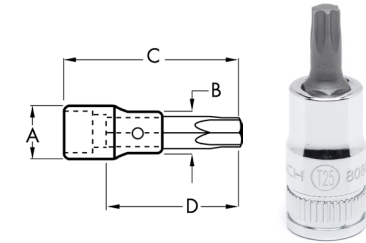

| Cat. No. | Fastener Size | Dim. A: Drive End | Dim. B: Nose Diameter | Dim. C: Overall Length | Dim. D: Bit Length | Product Weight |
|----------|---------------|-------------------|-----------------------|------------------------|--------------------|----------------|
| 80890    | T40           | 0.7 in            | 0.618 in              | 1.56 in                | 0.866 in           | 0.08 lb        |
| 80891    | T45           | 0.7 in            | 0.618 in              | 1.56 in                | 0.866 in           | 0.08 lb        |
| 80892    | T47           | 0.7 in            | 0.618 in              | 1.56 in                | 0.866 in           | 0.08 lb        |
| 80893    | T50           | 0.7 in            | 0.618 in              | 1.56 in                | 0.866 in           | 0.08 lb        |

### 3/8" Drive Stubby Torx® Bit Drivers

- Short overall length provides better access in tight spaces
- S2 steel for strength and durability
- Hard stamped size markings
- Satin finish for corrosion protection and simple cleaning
- Compact design provides additional access compared to standard bit sockets
- Includes socket rail for storage and organization



| Cat. No. | Fastener Size | Dim. A: Drive End | Dim. C: Overall Length | Dim. D: Bit Length | Product Weight |
|----------|---------------|-------------------|------------------------|--------------------|----------------|
| 81191    | T45           | 0.701 in          | 1.44 in                | -                  | 0.07 lb        |
| 81192    | T47           | 0.701 in          | 1.44 in                | -                  | 0.07 lb        |
| 81193    | T50           | 0.701 in          | 1.44 in                | 0.312 in           | 0.07 lb        |

### 3/8" Drive Tamper-Proof Torx® Bit Sockets

- For use with tamper-proof security fasteners
- Heat-treated socket base for durability
- S2 steel insert bits offer maximum strength
- Double line (SAE) and knurled (metric) ring help easily identify standard and metric sockets
- Hard stamped size markings
- Bright, full polish chrome finish easily wipes clean and resists corrosion
- Meets or exceeds ASME specifications

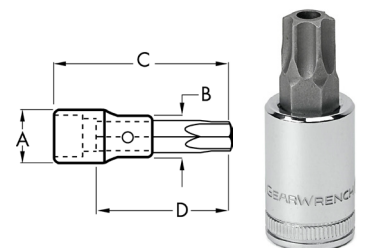

| Cat. No. | Fastener Size | Dim. A: Drive End | Dim. B: Nose Diameter | Dim. C: Overall Length | Dim. D: Bit Length | Product Weight |
|----------|---------------|-------------------|-----------------------|------------------------|--------------------|----------------|
| 80456D   | T40           | 0.688 in          | 0.590 in              | 1.85 in                | 1.181 in           | 0.35 lb        |
| 80457    | T45           | 0.688 in          | 0.590 in              | 1.85 in                | 1.181 in           | 0.39 lb        |
| 80458    | T50           | 0.688 in          | 0.590 in              | 1.85 in                | 1.181 in           | 0.45 lb        |
| 80459    | T55           | 0.75 in           | 0.75 in               | 1.85 in                | 1.181 in           | 0.45 lb        |

### 3/8" Drive Stubby Universal Tamper Proof Torx® Bit Sockets

- For use with tamper proof security fasteners
- Universal joint allows for greater access
- Bits made of S2 steel for strength and durability
- Optimized overall length provides even more access in tight spaces
- Hard stamped size markings
- Bright, full polish chrome finish easily wipes clean and resists corrosion



| Cat. No. | Fastener Size | Dim. A: Drive End | Dim. B: Nose Diameter | Dim. C: Overall Length | Exposed Bit Length | Product Weight |
|----------|---------------|-------------------|-----------------------|------------------------|--------------------|----------------|
| 81047    | T40           | 0.74 in           | 0.74 in               | 2.48 in                | 0.551 in           | 0.17 lb        |
| 81048    | T45           | 0.74 in           | 0.74 in               | 2.48 in                | 0.551 in           | 0.17 lb        |
| 81049    | T50           | 0.74 in           | 0.74 in               | 2.48 in                | 0.551 in           | 0.17 lb        |
| 81050    | T55           | 0.74 in           | 0.74 in               | 2.48 in                | 0.551 in           | 0.17 lb        |

### 3/8" Drive External Torx® Sockets

- For use with external torx fasteners
- Black oxide finish is corrosion resistant
- Heat treated socket for durability
- Hard stamped size markings
- For use with manual drive tools only



| Cat. No. | Fastener Size | Dim. A: Drive End | Dim. B: Nose Diameter | Dim. C: Overall Length | Dim. D: Bolt Clearance | Product Weight |
|----------|---------------|-------------------|-----------------------|------------------------|------------------------|----------------|
| 80460    | E10           | 0.75 in           | 0.75 in               | 1.24 in                | 0.196 in               | 0.12 lb        |
| 80461    | E12           | 0.75 in           | 0.75 in               | 1.24 in                | 0.314 in               | 0.14 lb        |
| 80462    | E14           | 0.75 in           | 0.75 in               | 1.24 in                | 0.314 in               | 0.16 lb        |
| 80463    | E16           | 0.75 in           | 0.75 in               | 1.24 in                | 0.314 in               | 0.18 lb        |

### 3/8" Drive Universal External Torx® Sockets

- Universal joint allows for greater access
- Hard stamped size markings
- Bright, full polish chrome finish easily wipes clean and resists corrosion



| Cat. No. | Fastener Size | Dim. A: Drive End | Dim. C: Overall Length | Product Weight |
|----------|---------------|-------------------|------------------------|----------------|
| 80976    | E4            | 0.74 in           | 2.05 in                | 0.13 lb        |
| 80977    | E5            | 0.74 in           | 2.05 in                | 0.13 lb        |
| 80978    | E6            | 0.74 in           | 2.05 in                | 0.13 lb        |
| 80979    | E7            | 0.74 in           | 2.05 in                | 0.13 lb        |

| Cat. No. | Fastener Size | Dim. A: Drive End | Dim. C: Overall Length | Product Weight |
|----------|---------------|-------------------|------------------------|----------------|
| 80980    | E8            | 0.74 in           | 2.05 in                | 0.13 lb        |
| 80981    | E10           | 0.74 in           | 2.05 in                | 0.14 lb        |
| 80982    | E12           | 0.74 in           | 2.05 in                | 0.14 lb        |
| 80983    | E14           | 0.74 in           | 2.05 in                | 0.14 lb        |
| 80984    | E16           | 0.74 in           | 2.05 in                | 0.14 lb        |

### 3/8" Drive Bit Sockets

- Heat-treated socket base for durability
- S2 steel insert bits offer maximum strength
- Double line (SAE) and knurled (metric) ring help easily identify standard and metric sockets
- Hard stamped size markings
- Bright, full polish chrome finish easily wipes clean and resists corrosion
- Meets or exceeds ASME specifications

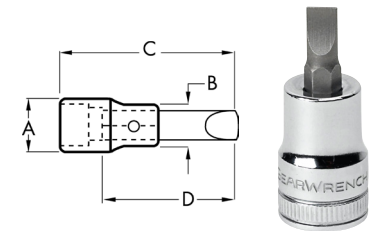

| Cat. No. | Drive Type | Fastener Size | Dim. A: Drive End | Dim. B: Nose Diameter | Dim. C: Overall Length | Dim. D: Bit Length | Product Weight |
|----------|------------|---------------|-------------------|-----------------------|------------------------|--------------------|----------------|
| 80464    | Slotted    | 4 mm          | 0.688 in          | 0.590 in              | 1.653 in               | 0.984 in           | 0.09 lb        |
| 80465    | Slotted    | 5 mm          | 0.688 in          | 0.590 in              | 1.653 in               | 0.984 in           | 0.10 lb        |
| 80466    | Slotted    | 6 mm          | 0.688 in          | 0.590 in              | 1.653 in               | 0.984 in           | 0.10 lb        |
| 80467    | Phillips®  | #1            | 0.688 in          | 0.590 in              | 1.653 in               | 0.984 in           | 0.09 lb        |
| 80468    | Phillips®  | #2            | 0.688 in          | 0.590 in              | 1.653 in               | 0.984 in           | 0.09 lb        |
| 80469    | Phillips®  | #3            | 0.688 in          | 0.590 in              | 1.653 in               | 0.984 in           | 0.10 lb        |
| 80470    | Pozidriv®  | #2            | 0.688 in          | 0.590 in              | 1.653 in               | 0.984 in           | 0.09 lb        |

### 3/8" Drive Triple Square Bit Sockets

- S2 steel insert bits offer maximum strength
- Heat-treated socket base for durability
- Hard stamped size markings
- Double line (SAE) and knurled (metric) ring help easily identify standard and metric sockets
- Bright, full polish chrome finish easily wipes clean and resists corrosion
- Meets or exceeds ASME specifications

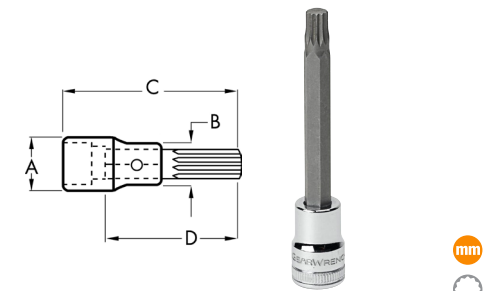

| Cat. No. | Fastener Size | Dim. A: Drive End | Dim. B: Nose Diameter | Dim. C: Overall Length | Dim. D: Bit Length | Product Weight |
|----------|---------------|-------------------|-----------------------|------------------------|--------------------|----------------|
| 80449    | 6 mm          | 0.69 in           | 0.313 in              | 3.15 in                | 2.48 in            | 0.15 lb        |
| 80736    | 8 mm          | 0.7 in            | 0.618 in              | 1.89 in                | 1.181 in           | 0.09 lb        |
| 80450    | 8 mm          | 0.69 in           | 0.313 in              | 3.66 in                | 3.66 in            | 0.15 lb        |
| 80868    | 8 mm          | 0.7 in            | 0.618 in              | 3.94 in                | 3.228 in           | 0.14 lb        |

**1/2" Drive Triple Square Bit Sockets** ■ *Continued from previous page*

| Cat. No. | SAE/Metric | Length Format | Fastener Size | Dim. A: Drive End | Dim. B: Nose Diameter | Dim. C: Overall Length | Dim. D: Bit Length | Product Weight |
|----------|------------|---------------|---------------|-------------------|-----------------------|------------------------|--------------------|----------------|
| 80739    | Metric     | Stubby        | 14 mm         | 0.937 in          | 0.865 in              | 2.17 in                | 1.181 in           | 0.23 lb        |
| 80740    | Metric     | Stubby        | 16 mm         | 1.015 in          | 0.959 in              | 2.17 in                | 1.181 in           | 0.30 lb        |
| 80741    | Metric     | Stubby        | 18 mm         | 1.094 in          | 1.040 in              | 2.17 in                | 1.181 in           | 0.36 lb        |
| 80869    | Metric     | Long          | 10 mm         | 0.858 in          | 0.697 in              | 3.94 in                | 2.952 in           | 0.23 lb        |
| 80870    | Metric     | Long          | 12 mm         | 0.937 in          | 0.817 in              | 3.94 in                | 2.952 in           | 0.31 lb        |
| 80871    | Metric     | Long          | 14 mm         | 0.937 in          | 0.878 in              | 3.94 in                | 2.952 in           | 0.36 lb        |
| 80872    | Metric     | Long          | 16 mm         | 1.015 in          | 0.96 in               | 3.94 in                | 2.952 in           | 0.49 lb        |
| 80665    | Metric     | Extra Long    | 10 mm         | 0.944 in          | 0.748 in              | 4.21 in                | 3.180 in           | 0.38 lb        |
| 80666    | Metric     | Extra Long    | 12 mm         | 0.944 in          | 0.944 in              | 4.68 in                | 3.660 in           | 0.38 lb        |

**1/2" Drive Torx® Bit Sockets**

- Heat-treated socket base for durability
- S2 steel insert bits offer maximum strength
- Double line (SAE) and knurled (metric) ring help easily identify standard and metric sockets
- Hard stamped size markings
- Bright, full polish chrome finish easily wipes clean and resists corrosion
- Meets or exceeds ASME specifications

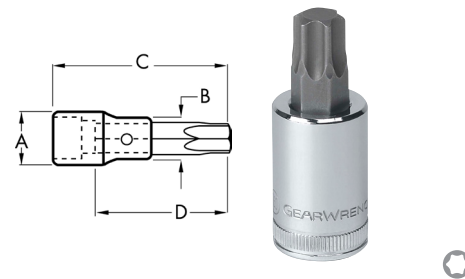

| Cat. No. | Fastener Size | Dim. A: Drive End | Dim. B: Nose Diameter | Dim. C: Overall Length | Dim. D: Bit Length | Product Weight |
|----------|---------------|-------------------|-----------------------|------------------------|--------------------|----------------|
| 80667    | T60           | 0.944 in          | 0.944 in              | 2.48 in                | 1.49 in            | 0.30 lb        |

**1/2" Drive Stubby Torx® Bit Sockets**

- Reduced overall bit length provides better access in tight spaces
- S2 steel insert bits offer maximum strength
- Heat-treated socket base for durability
- Hard stamped size markings
- Bright, full polish chrome finish easily wipes clean and resists corrosion
- Meets or exceeds ASME specifications

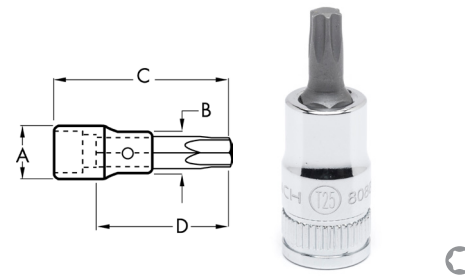

| Cat. No. | Fastener Size | Dim. A: Drive End | Dim. B: Nose Diameter | Dim. C: Overall Length | Dim. D: Bit Length | Product Weight |
|----------|---------------|-------------------|-----------------------|------------------------|--------------------|----------------|
| 80894    | T55           | 0.858 in          | 0.700 in              | 2.15 in                | 1.181 in           | 0.16 lb        |
| 80896    | T60           | 0.937 in          | 0.817 in              | 2.15 in                | 1.181 in           | 0.16 lb        |

**1/2" Drive Tamper-Proof Torx® Bit Sockets**

- For use with tamper-proof security fasteners
- Heat-treated socket base for durability
- S2 steel insert bits offer maximum strength
- Double line (SAE) and knurled (metric) ring help easily identify standard and metric sockets
- Hard stamped size markings
- Bright, full polish chrome finish easily wipes clean and resists corrosion
- Meets or exceeds ASME specifications

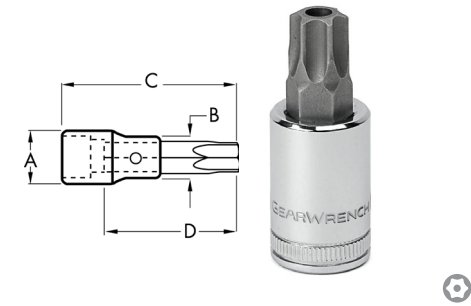

| Cat. No. | Fastener Size | Dim. A: Drive End | Dim. B: Nose Diameter | Dim. C: Overall Length | Dim. D: Bit Length | Product Weight |
|----------|---------------|-------------------|-----------------------|------------------------|--------------------|----------------|
| 80668    | T60           | 0.944 in          | 0.944 in              | 2.48 in                | 1.49 in            | 0.30 lb        |

**1/2" Drive External Torx® Sockets**

- For use with External Torx® fasteners
- Black oxide finish is corrosion resistant
- Heat treated socket for durability
- Hard stamped size markings
- For use with manual drive tools only



| Cat. No. | Fastener Size | Dim. A: Drive End | Dim. B: Nose Diameter | Dim. C: Overall Length | Product Weight |
|----------|---------------|-------------------|-----------------------|------------------------|----------------|
| 80669D   | E18           | 0.944 in          | 0.944 in              | 1.5 in                 | 0.30 lb        |
| 80670    | E20           | 0.944 in          | 0.944 in              | 1.75 in                | 0.34 lb        |
| 80672    | E22           | 1.125 in          | 1.125 in              | 2 in                   | 0.36 lb        |
| 80673    | E24           | 1.125 in          | 1.125 in              | 2 in                   | 0.38 lb        |

**27 Pc. 3/4" Drive 12 Point SAE Mechanics Tool Set**

- 24-tooth full polish chrome quick-release ratchet
- Full polish chrome sockets with large hard-stamped size markings
- Knurled full polish chrome extensions
- Sockets feature off-corner loading design to reduce fastener rounding
- Includes metal box for storage and organization
- Meets or exceeds ASME specifications



| Cat. No. | Included Storage | Product Weight |
|----------|------------------|----------------|
| 80880    | Metal Box        | 26.40 lb       |

| Cat. No. | Description  | Cat. No. | Description                                      |
|----------|--|----------|--|
| 81400    | 3/4" Drive 24-Tooth Quick Release Teardrop Ratchet 19-3/4" | 80841    | 3/4" Drive 12 Point Standard SAE Socket 1-3/8"   |
| 81404    | 3/4" Drive Breaker Bar 19"                                 | 80852    | 3/4" Drive 12 Point Standard SAE Socket 1-7/16"  |
| 81401    | 3/4" Drive Sliding T Handle 18"                            | 80854    | 3/4" Drive 12 Point Standard SAE Socket 1-1/2"   |
| 81411    | 3/4" Drive Extension 5"                                    | 80855D   | 3/4" Drive 12 Point Standard SAE Socket 1-5/8"   |
| 81412    | 3/4" Drive Extension 8"                                    | 80856    | 3/4" Drive 12 Point Standard SAE Socket 1-11/16" |

■ *Continued on next page*